

96573398 GT-HR-140 PN6 R1 V 50 Hz

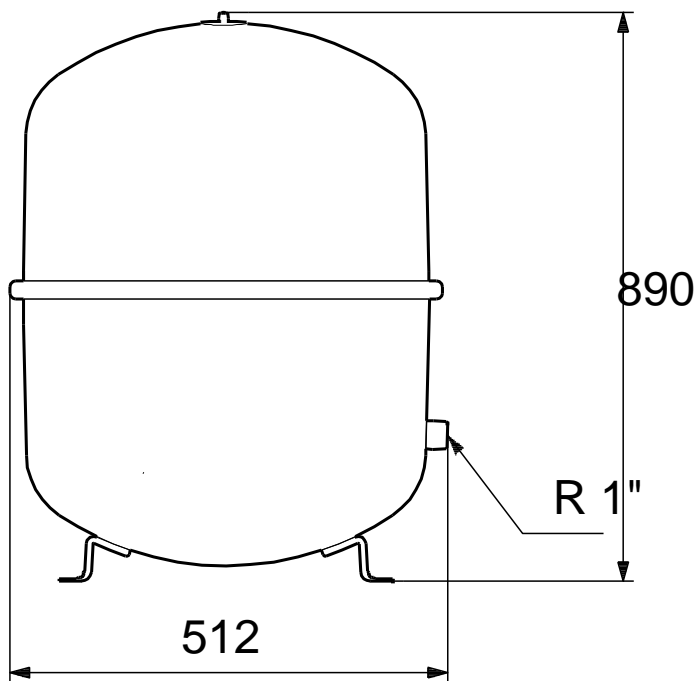

Note! All units are in [mm] unless others are stated.
Disclaimer: This simplified dimensional drawing does not show all details.