



CitySpirit Street

CDS480 CDO-TT150W K II OR GR ST 60P

CitySpirit S - MASTER CityWhite CDO-TT - 150 W - Open CT-POT - Post-top for diameter 60 mm

CitySpirit is a range of street-lighting luminaires designed to provide excellent, environmentally friendly lighting without compromising on architectural appearance. The distinctive designs are clearly linked yet allow modularity. To ensure perfect integration in the urban streetscape, the luminaire, mast and bracket of CitySpirit have been developed as one design. The range provides elegant and above all complete project solutions. Furthermore, transparent materials have been used to lighten the daytime appearance. CitySpirit incorporates several optical concepts, which address issues such as spacing, night preservation, visual comfort and light trespass. All CitySpirit indirect versions are retrofit luminaires, which can be equipped with conventional or LED light sources. In combination with different optical reflectors they deliver indirect high-quality warm white light. CitySpirit indirect LED has an upgradeable LED light engine, which ensures future-proof performance. Together with its constant light output and dimming functionality, the LED version ensures the highest operational efficiency. The range further comprises Cone, Torch, Modern Lantern, Classic Lantern, Street, Wall-mounted and Bollard models.

Product data

General Information			
Number of light sources	1 pc	Gear	CONV [Conventional]
Lamp family code	CDO-TT [MASTER CityWhite CDO-TT]	Driver/power unit/transformer	-
Lamp power	150 W	Driver included	Yes
Cap-Base	E40 [E40]	Optical cover/lens type	Flat glass
Kombipack	Lamp(s) included	Embedded control	-
Light source replaceable	Yes	Light regulation	-
Compensation circuit	-	Electrical circuit protection	-
		Cable	-

CitySpirit Street

Protection class IEC	Safety class II
Parts color	-
Coating	-
Glow-wire test	Temperature 850 °C, duration 5 s
CE mark	CE mark
ENEC mark	ENEC mark
Design Award Winner mark	Design Award Winner 2008
Green Flagship mark	Green Flagship
Optic type outdoor	Open CT-POT
RAL color	-
Photocell	-
Product family code	CDS480 [CitySpirit S]

Light Technical

Standard tilt angle posttop	5°
-----------------------------	----

Operating and Electrical

Input Voltage	230 V
Input Frequency	50 to 60 Hz
Ignitor	Semi-parallel self-stopping

Controls and Dimming

Dimmable	No
----------	----

Mechanical and Housing

Housing Material	Aluminum
Optic material	Acrylate
Mounting device	Post-top for diameter 60 mm

Approval and Application

Ingress protection code	IP65 [Dust penetration-protected, jet-proof]
Mech. impact protection code	IK09 [10 J]

Product Data

Full product code	871155972688500
Order product name	CDS480 CDO-TT150W K II OR GR ST 60P
EAN/UPC - Product	8711559726885
Order code	910403720812
Numerator - Quantity Per Pack	1
Numerator - Packs per outer box	1
Material Nr. (12NC)	910403720812
Net Weight (Piece)	15.664 kg

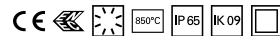

Dimensional drawing

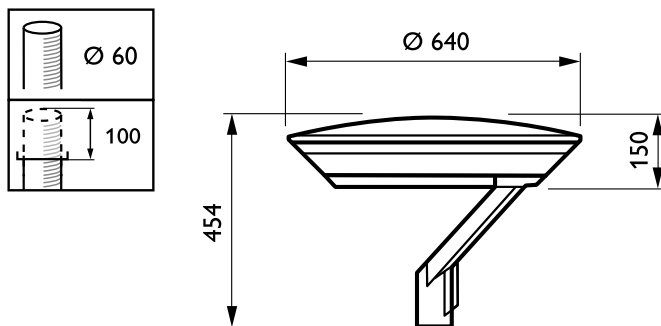

CitySpirit BDS480, CDS480/482

