

# Ceiling diffusers



About Lindab	1
Comfort and Design	2
Product overview / symbols	3
Theory	4
<b>Ceiling diffusers</b>	<b>5</b>
Ceiling diffusers - visible	6
Plenum boxes	7
Wall diffusers	8
Nozzles	9
Ventiduct	10
Grilles	11
Displacement diffusers	12
Pascal and VAV	13
Constant- / variable flow dampers	14
Air valves	15
Fresh air valves/overflow units	16
Cleanroom diffusers	17
Contents	18

# Ceiling diffusers

1  
2  
3  
4  
**5**  
6  
7  
8  
9  
10  
11  
12  
13  
14  
15  
16  
17  
18

## Formo

Aesthetic design



Product	Page
Introduction	51
Overview of combinations	53
PKA	57
PCA	69
LKA	81
LCA	93
CRL	105

## Integra

Integrated design



Product	Page
Introduction	117
Overview of combinations	121
PC6	125
PC7	135
RC14	141
RC15	151
NC19	161
RCG	169
LCC	176
LKP/LCP	177

## Versio

Countless opportunities



Product	Page
Introduction	187
Overview of combinations	188
PS1	195
PS8	205
RS14	213
RS15	227
RS16	239
NS19	247
GS23	255

## Lineo

Clean lines



Product	Page
Introduction	261
MTL	265
STB	272
STU	272

## Extraction above ceiling



Product	Page
PCY	273
PKY	273

## Ceiling tile adaption

274

# Lindab Formo

a series of architecturally designed diffusers



PCA, Terminal 3 - Copenhagen Airport

## Lindab Formo

Mixed ventilation is the most used principle of ventilation there is. Mixed ventilation is typically used in offices and similar rooms, where you wish to maintain low velocities in the occupied zone as well as low temperature gradients from floor to ceiling. The best results with mixed ventilation is obtained by spreading the air over the entire ceiling area, so that the velocity can subside as much as possible before reaching the occupied zone. There is a large selection of ceiling diffusers in different designs and with different functions, which can be used depending on the room's dimensions.

## Functionality

Formo mixed ventilation diffusers are known by the diffusers being suspended from the ceiling with a single slot around the diffusers. The diffusers are offered in circular, or square designs with perforated or plain front plates. The diffusers have a very high capacity and are available with several different types of accessories. The circular diffusers are normally cut directly into the ceiling when mounted, but can by using tileplates be adapted for the most common 600x600 mm ceiling systems. On the next few pages, is illustrated a combinatic overview which will provide for a good insight to the series.



PCA, ceiling diffuser



# Lindab Formo

a series of architectural designed diffusers

## Design

See [Comfort and design](#)



Ventilations - principle  
Supp./Exhau.

## Accessories

Details, see productpages



Product

	Perforated - square	Perforated - circular	Plain - square	Plain - circular	Plain - circular
<b>PKA</b>	 125 160 200 250 315 400	 100 125 160 200 250 315 400	 125 160 200 250 315 400	 100 125 160 200 250 315 400	 100 125 160 200 250 315 400
	El. - motor	El. - motor	El. - motor	El. - motor	El. - motor
	Bracket	Bracket	Bracket	Bracket	Bracket
	Module pl.	Module pl.	Module pl.	Module pl.	Module pl.
	1, 2, 3 way	1, 2, 3 way	1, 2, 3 way	1, 2, 3 way	1, 2, 3 way
	Damper	Damper	Damper	Damper	Damper
	MBB box	MBB box	MBB box	MBB box	MBB box

Electrical motor:   
See VAV chapter for further documentation.

- 1. Product and tech. data depicted in catalogue.
- 2. Combination possible. Tech. data depicted in catalogue.
- 3. Combination possible. Tech. data not in catalogue.
- 4. If space is empty, combination is not possible.

### Example of order Diffuser + MBB box



PCA 160 + MBB 125 160 S

1  
2  
3  
4  
5  
6  
7  
8  
9  
10  
11  
12  
13  
14  
15  
16  
17  
18

# Lindab Formo a series of architectural designed diffusers

## Ceiling tile adaption

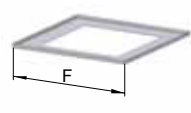
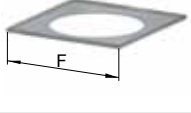
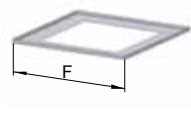
Details, see [Chapter ceiling tile adaption](#)

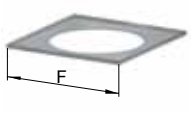
Product		Size	1	3	4	5	6	7
<b>Ceiling types</b>			Danotile T24/T15 Ecophon T24 Rockfon A24.	Permanent ceiling	Dampa Clip-In bevelled edge	Dampa Clip-In square edge	Luxalon SQ Clip-In	Danotile Contur Ecophon D Rockfon D-XL
<b>Perforated - square</b>		<b>mm</b>	F: 595 mm	A x A mm	F: 600 mm	F: 600 mm	F: 600 mm	F: 599 mm
<b>PKA</b>		125	●	Standard	●	●	●	●
		160	●	Standard	●	●	●	●
		200	●	Standard	●	●	●	●
		250	●	Standard	●	●	●	●
		315	●	Standard *	●	●	●	●
		400	●	Standard *	●	●	●	●
<b>Perforated - circular</b>		<b>mm</b>	F: 595 mm	ØD mm	F: 600 mm	F: 600 mm	F: 600 mm	F: 599 mm
<b>PCA</b>		100	●	Standard	●	●	●	●
		125	●	Standard	●	●	●	●
		160	●	Standard	●	●	●	●
		200	●	Standard	●	●	●	●
		250	●	Standard	●	●	●	●
		400	●	Standard	●	●	●	●
<b>Plain - square</b>		<b>mm</b>	F: 595 mm	A x A mm	F: 600 mm	F: 600 mm	F: 600 mm	F: 599 mm
<b>LKA</b>		125	●	Standard	●	●	●	●
		160	●	Standard	●	●	●	●
		200	●	Standard	●	●	●	●
		250	●	Standard	●	●	●	●
		315	●	Standard *	●	●	●	●
		400	●	Standard *	●	●	●	●
<b>Plain - circular</b>		<b>mm</b>	F: 595 mm	ØD mm	F: 600 mm	F: 600 mm	F: 600 mm	F: 599 mm
<b>LCA</b>		100	●	Standard	●	●	●	●
		125	●	Standard	●	●	●	●
		160	●	Standard	●	●	●	●
		200	●	Standard	●	●	●	●
		250	●	Standard	●	●	●	●
		400	●	Standard	●	●	●	●
<b>Plain - circular</b>		<b>mm</b>	F: 595 mm	ØA mm	F: 600 mm	F: 600 mm	F: 600 mm	F: 599 mm
<b>CRL</b>		100		Standard				
		125		Standard				
		160		Standard				
		200		Standard				
		250		Standard				
		400		Standard				

\* In other ceiling systems the overpart of the diffuser is adapted to the ceiling. No separate Modulplatte.

- 1. Product and tech. data depicted in catalogue.
- 2. Combination possible. Tech. data depicted in catalogue.
- 3. Combination possible. Tech. data not in catalogue.
- 4. If space is empty, combination is not possible.





### Example of order Moduleplate

LM	1	PCA	160
----	---	-----	-----

# Lindab Formo a series of architectural designed diffusers

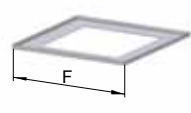
## Ceiling tile adaption

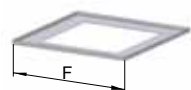
Details, see [Chapter ceiling tile adaption](#)

Product		Size	8	9	10	11	14	
Ceiling types			Ecophon Focus DG	Rockfon E10 24 Ecophon -E / T24	Rockfon E10 15 Ecophon -E / T15	Danotile Markant	Ecophon Focus edge DS	
Perforated - square		mm	F: 592mm	F: 575mm	F: 584 mm	F: 575 mm	F: 599 mm	
<b>PKA</b>		125	●	●	●	●	●	
		160	●	●	●	●	●	
		200	●	●	●	●	●	
		250	●	●	●	●	●	
		315	●	●	●	●	●	
400	●	●	●	●	●			
Perforated - circular		mm	F: 592mm	F: 575mm	F: 584 mm	F: 575 mm	F: 599 mm	
<b>PCA</b>		100	●	●	●	●	●	
		125	●	●	●	●	●	
		160	●	●	●	●	●	
		200	●	●	●	●	●	
		250	●	●	●	●	●	
		315	●	●	●	●	●	
		400	●	●	●	●	●	
Plain - square		mm	F: 592mm	F: 575mm	F: 584 mm	F: 575 mm	F: 599 mm	
<b>LKA</b>		125	●	●	●	●	●	
		160	●	●	●	●	●	
		200	●	●	●	●	●	
		250	●	●	●	●	●	
		315	●	●	●	●	●	
400	●	●	●	●	●			
Plain - circular		mm	F: 592mm	F: 575mm	F: 584 mm	F: 575 mm	F: 599 mm	
<b>LCA</b>		100	●	●	●	●	●	
		125	●	●	●	●	●	
		160	●	●	●	●	●	
		200	●	●	●	●	●	
		250	●	●	●	●	●	
		315	●	●	●	●	●	
		400	●	●	●	●	●	
Plain - circular		mm	F: 592mm	F: 575mm	F: 584 mm	F: 575 mm	F: 599 mm	
<b>CRL</b>		100						
		125						
		160						
		200						
		250						
		315						
		400						

- 1. Product and tech. data depicted in catalogue.
- 2. Combination possible. Tech. data depicted in catalogue.
- 3. Combination possible. Tech. data not in catalogue.
- 4. If space is empty, combination is not possible.

1
2
3
4
<b>5</b>
6
7
8
9
10
11
12
13
14
15
16
17
18





# Perforated diffuser

# PKA



## Description

PKA is a square diffuser with perforated face plate. PKA can be used for both supply and exhaust air. PKA is suitable for horizontal supply of cooled air and can be equipped with accessories of various types in order to achieve optimal function. Installing a PKA diffuser in a plenum box type MBB can help to achieve a stable airflow to the diffuser as well as realise the potential for individual adjustment.

- Suitable for both supply and exhaust air
- Suitable for horizontal supply of cooled air
- Option of 1, 2 and 3-way supply air

## Maintenance

The face plate can be removed to enable cleaning of internal parts or to gain access to the duct or box. The visible parts of the diffuser can be wiped with a damp cloth.

## Dimensions

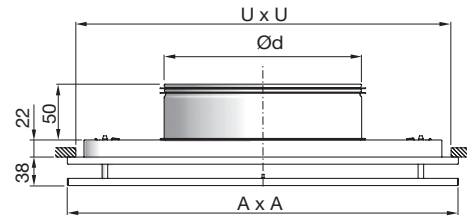

PKA Ød mm	A mm	U * mm	Free area A m <sup>2</sup>	Weight kg
125	235	200	0,018	1,10
160	295	260	0,023	1,80
200	395	360	0,03	2,80
250	495	460	0,043	4,20
315	595	560	0,057	5,70
400	595	560	0,075	5,70

\* U x U = Ceiling grid opening

## Order code

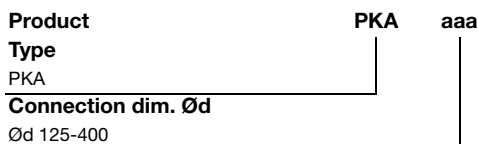

Example: PKA-200

## Materials and finish

Material: Galvanised steel  
 Standard finish: Powder-coated  
 Standard colour: White RAL 9010, gloss 30

The diffuser is available in other colours. Please contact Lindab's sales department for further information.

# Perforated diffuser

# PKA

## Accessories

### DRZ - Balancing damper

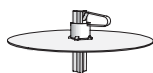
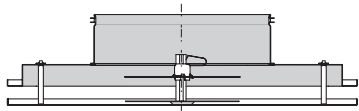

### Blending profiles (set)

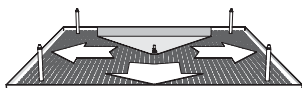
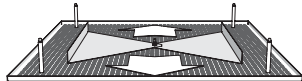
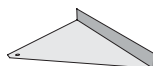
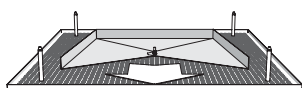

### MBZ - Extension piece



### DKZ - Mounting brackets (set)

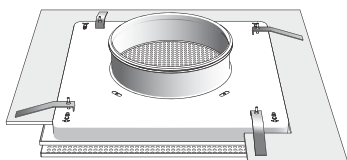
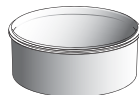

### Order code - accessories

Product	aaa	bbb
Type		
Size		

Example: DRZ-200

### LM - Module plate



### Order code - module plate

Product	LM	a	PKA	ccc
Type				
Ceiling system				
Diffuser				
Size				

Example: LM-1-PKA-200

Ceiling system - see introductory summary.

## MBB - Plenum box



### PKA + MBB

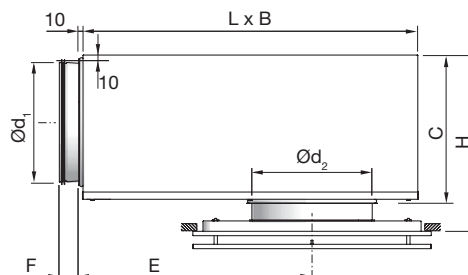

PKA + MBB		B mm	C mm	E mm	F mm	H* mm	L mm
duct Ød <sub>1</sub> mm	PKA Ød <sub>2</sub> mm						
100	125	260	159	216	50	180 - 220	310
100	160	260	159	216	50	180 - 220	310
125	125	310	184	262	50	205 - 245	376
125	160	310	184	262	50	205 - 245	376
125	200	310	184	262	50	205 - 245	376
160	160	380	220	323	50	239 - 279	459
160	200	380	220	323	50	239 - 279	459
160	250	380	220	323	50	239 - 279	459
200	200	460	259	396	70	280 - 320	565
200	250	460	259	396	70	280 - 320	565
200	315	460	259	396	70	280 - 320	565
250	250	540	309	486	70	330 - 370	698
250	315	540	309	486	70	330 - 370	698
250	400	540	309	486	70	330 - 370	698
315	315	540	373	646	70	395 - 435	858
315	400	540	373	646	70	395 - 435	858

\* Using accessory MBZ the H dimension will increase:

Ød<sub>2</sub> = 125 - 200 mm => H +40 mm

Ød<sub>2</sub> = 250 - 315 mm => H +60 mm

Ød<sub>2</sub> = 400 mm => H +80 mm

## Order code

Product	MBB	aaa	bbb	c
Type				
MBB				
Duct connection Ød <sub>1</sub>				
Ø100-315				
Diffuser dimension Ød <sub>2</sub>				
Ø125-400				
Function				
S = Supply air				
E = Exhaust				

Example: PKA-200+MBB-160-200-S

# Perforated diffuser

# PKA

## Technical data

### Capacity

Air flow  $q_v$  [l/s] and [m<sup>3</sup>/h], total pressure  $\Delta p_t$  [Pa], throw  $l_{0,2}$  [m] and sound power level  $L_{WA}$  [dB(A)] can be seen in the diagrams.

### Frequency-related sound effect level

The sound effect level in the frequency band is defined as  $L_{WA} + K_{ok}$ .  $K_{ok}$  values are specified in charts beneath the diagrams on the following pages.

### Quick selection, supply air

PKA + MBB		$\Delta p_t \geq 50$ Pa 30 dB(A)		$\Delta p_t \geq 50$ Pa 35 dB(A)	
duct	PKA	l/s	m <sup>3</sup> /h	l/s	m <sup>3</sup> /h
$\varnothing d_1$	$\varnothing d_2$				
100	125	33	119	39	140
100	160	39	140	47	169
125	125	40	144	48	173
125	160	51	184	61	220
125	200	58	209	70	252
160	160	59	212	70	252
160	200	67	241	84	302
160	250	77	277	99	356
200	200	83	299	100	360
200	250	96	346	118	425
200	315	112	403	139	500
250	250	118	425	139	500
250	315	133	479	163	587
250	400	128	461	174	626
315	315	145	522	173	623
315	400	173	623	209	752

### Sound attenuation

Sound attenuation of the diffuser  $\Delta L$  from duct to room, including end reflection, see table below.

PKA + MBB		Centre frequency Hz							
duct	PKA	63	125	250	500	1K	2K	4K	8K
$\varnothing d_1$	$\varnothing d_2$								
100	125	19	16	7	19	18	18	18	21
100	160	21	16	5	15	17	18	16	19
125	125	18	13	9	20	13	19	18	19
125	160	12	13	8	19	13	16	17	19
125	200	16	11	5	16	13	15	15	17
160	160	17	17	11	19	18	17	20	20
160	200	14	14	7	21	15	16	18	19
160	250	15	15	5	17	13	15	16	18
200	200	15	10	6	16	17	15	19	18
200	250	12	9	5	14	17	15	17	17
200	315	12	7	4	11	15	14	16	15
250	250	14	8	8	14	16	17	17	18
250	315	12	6	6	15	15	15	16	17
250	400	13	5	4	13	14	14	15	15
315	315	7	9	8	14	17	16	17	21
315	400	7	8	8	12	16	16	16	18

### Balancing

Balancing data is contained in a separate brochure.

### Throw $l_{0,2}$

The throw is specified at a terminal velocity of 0.2 m/s.

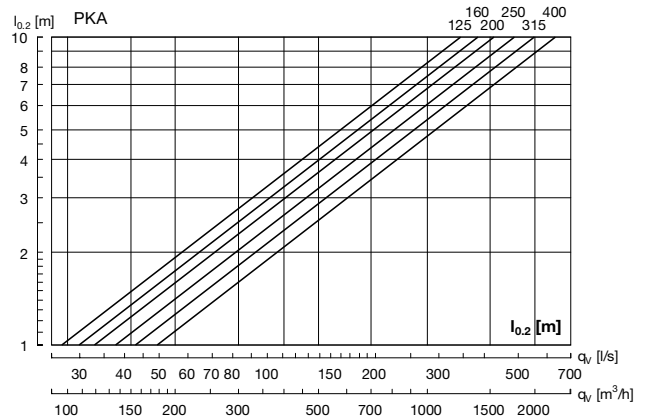

### Correction throw $l_{0,2}$

PKA $\varnothing d$	1 - ways	2 - ways	3 - ways
125	2.6	1.8	1.4
160	2.5	1.7	1.3
200	2.4	1.7	1.3
250	2.3	1.7	1.3
315	2.2	1.7	1.2
400	2.3	1.7	1.2

### Air jet distribution

$l_b$  = Distance from the diffuser to the point where there is maximum dispersal.

$b_v$  = Depth of the air jet on a vertical plane.

$b_h$  = Width of the air jet on a horizontal plane.

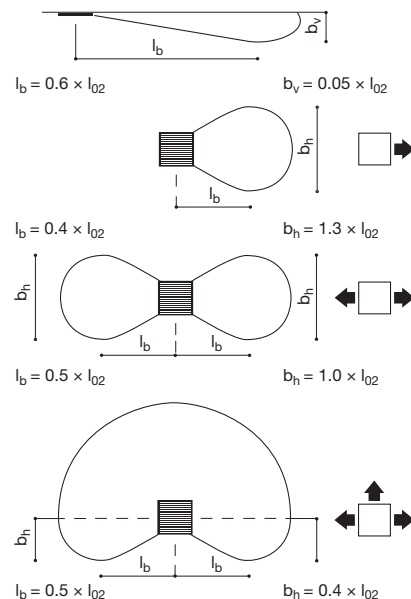

# Perforated diffuser

PKA

## Technical data

### PKA without box - Supply air

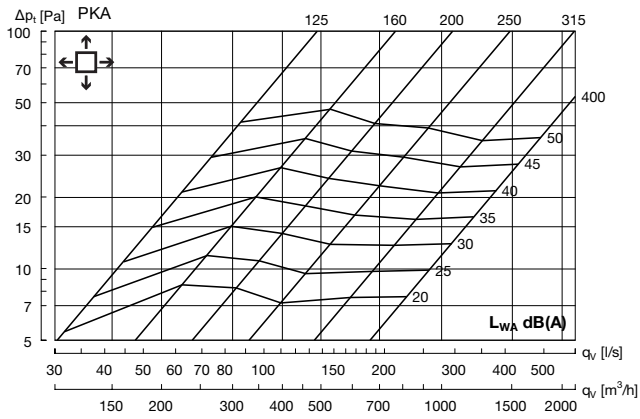

### PKA 125 + MBB - Supply air

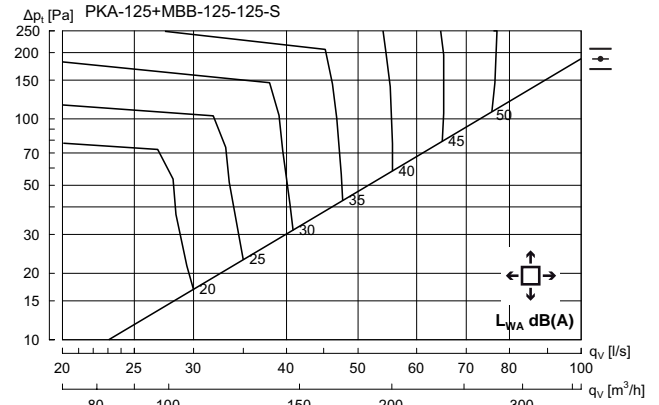

Hz	63	125	250	500	1K	2K	4K	8K
K <sub>uk</sub>	9	5	-1	-4	-3	-11	-20	-26

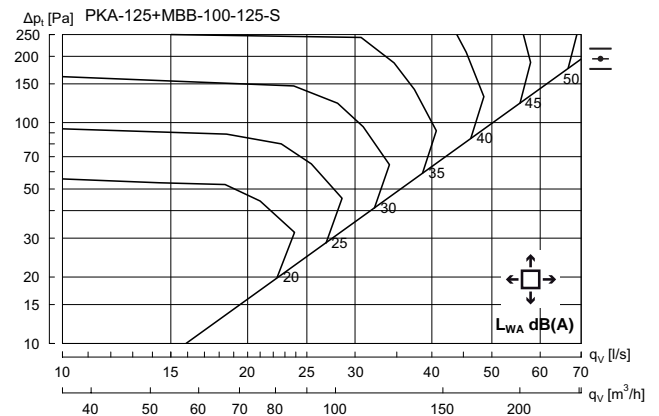

Hz	63	125	250	500	1K	2K	4K	8K
K <sub>uk</sub>	11	7	3	-5	-5	-11	-18	-25

1

2

3

4

5

6

7

8

9

10

11

12

13

14

15

16

17

18

# Perforated diffuser

# PKA

## Technical data

### PKA 160 + MBB - Supply air

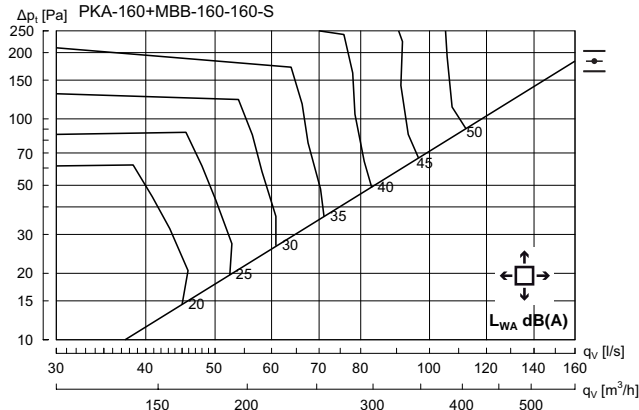

Hz	63	125	250	500	1K	2K	4K	8K
$K_{ok}$	8	5	-2	-4	-3	-11	-21	-29

### PKA 200 + MBB - Supply air

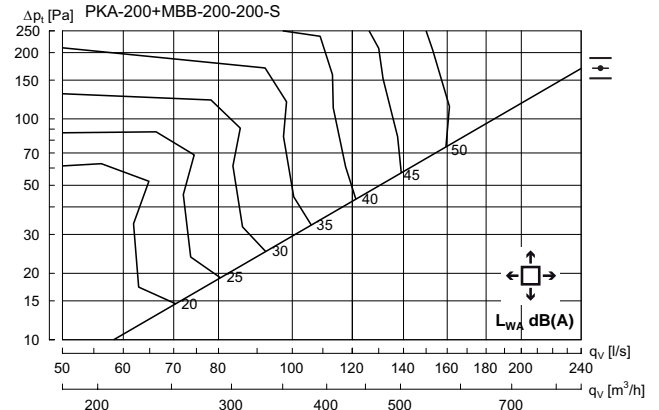

Hz	63	125	250	500	1K	2K	4K	8K
$K_{ok}$	11	5	-3	-3	-3	-11	-22	-29

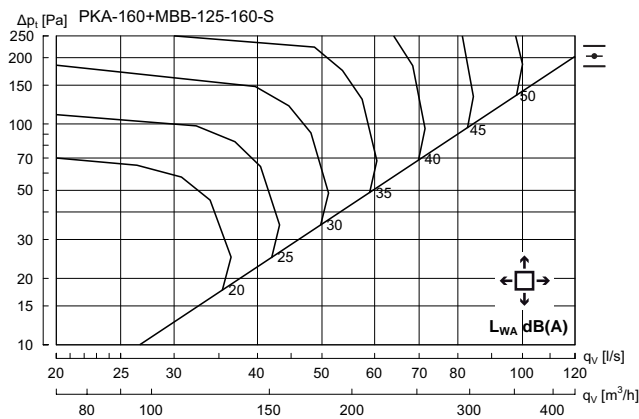

Hz	63	125	250	500	1K	2K	4K	8K
$K_{ok}$	9	5	1	-4	-4	-10	-17	-25

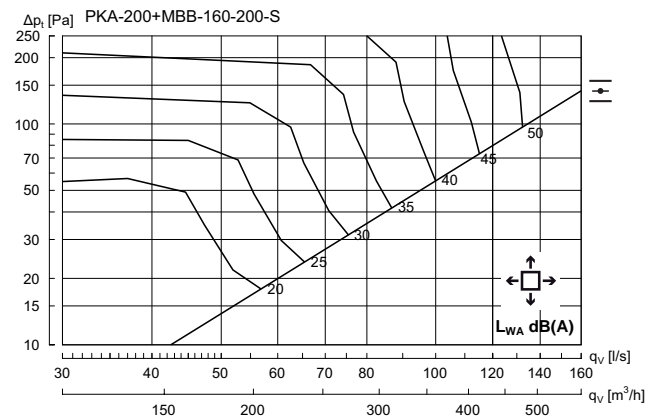

Hz	63	125	250	500	1K	2K	4K	8K
$K_{ok}$	10	5	-2	-4	-3	-10	-20	-26

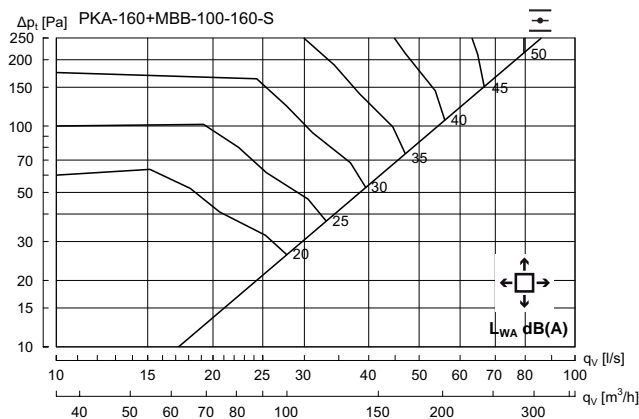

Hz	63	125	250	500	1K	2K	4K	8K
$K_{ok}$	9	4	1	-3	-5	-10	-15	-19

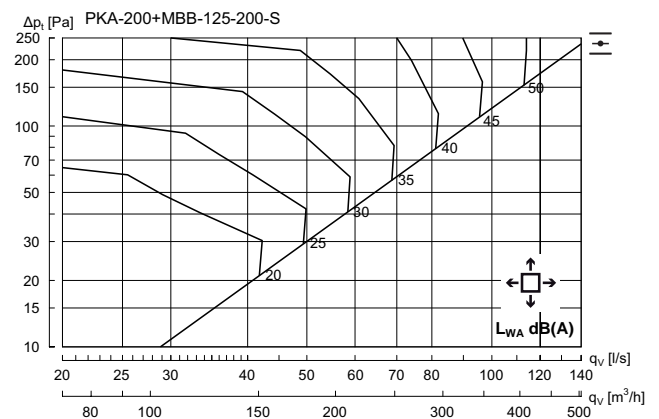

Hz	63	125	250	500	1K	2K	4K	8K
$K_{ok}$	10	5	1	-4	-5	-10	-15	-22

# Perforated diffuser

# PKA

## Technical data

### PKA 250 + MBB - Supply air

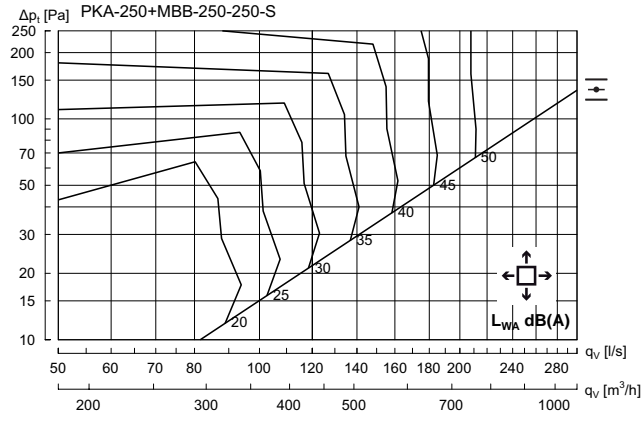

Hz	63	125	250	500	1K	2K	4K	8K
$K_{ok}$	11	3	-4	-3	-3	-12	-22	-30

### PKA 315 + MBB - Supply air

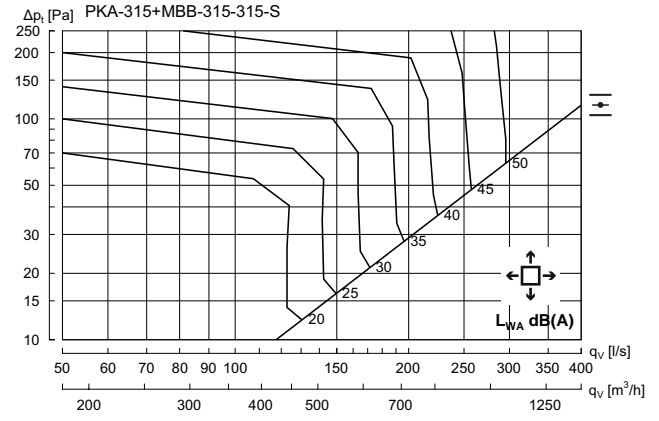

Hz	63	125	250	500	1K	2K	4K	8K
$K_{ok}$	12	2	-3	-2	-3	-13	-23	-33

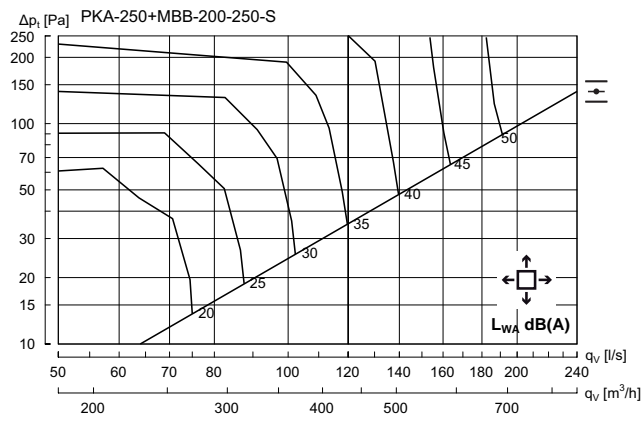

Hz	63	125	250	500	1K	2K	4K	8K
$K_{ok}$	10	5	-2	-3	-3	-11	-20	-28

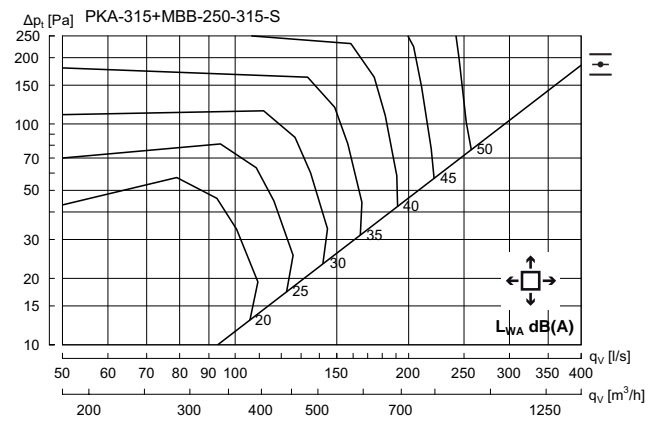

Hz	63	125	250	500	1K	2K	4K	8K
$K_{ok}$	11	3	-2	-3	-4	-11	-18	-27

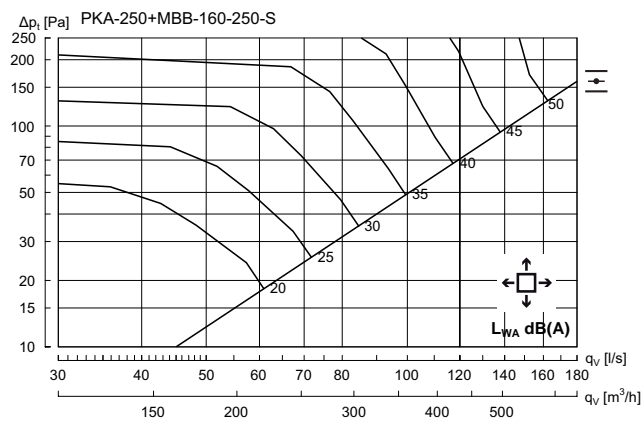

Hz	63	125	250	500	1K	2K	4K	8K
$K_{ok}$	8	5	0	-4	-4	-10	-17	-23

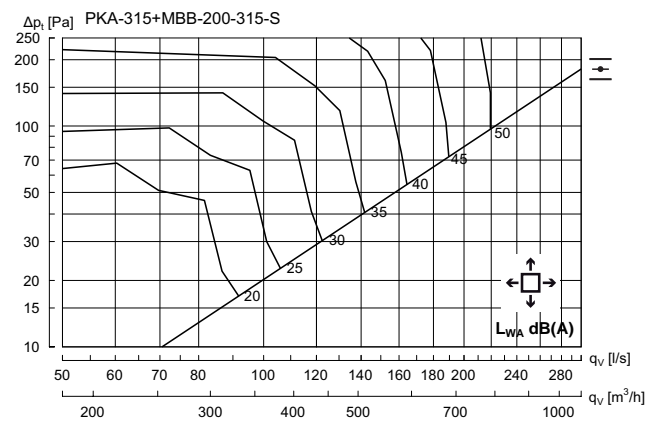

Hz	63	125	250	500	1K	2K	4K	8K
$K_{ok}$	10	5	-1	-3	-4	-11	-19	-25

# Perforated diffuser

# PKA

## Technical data

### PKA 400 + MBB - Supply air

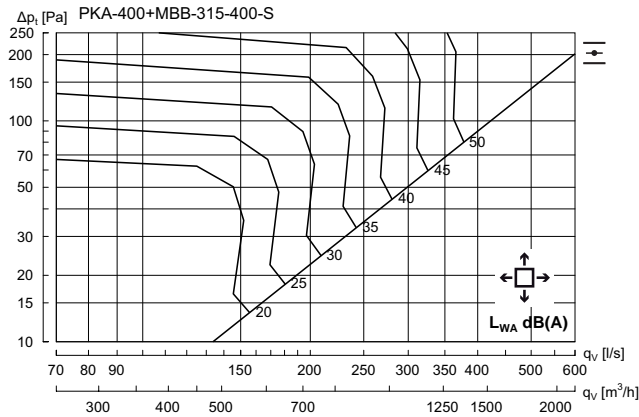

Hz	63	125	250	500	1K	2K	4K	8K
$K_{sk}$	14	2	0	-2	-5	-13	-17	-26

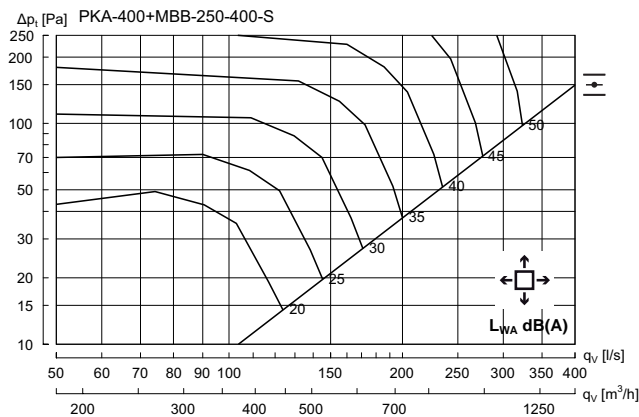

Hz	63	125	250	500	1K	2K	4K	8K
$K_{sk}$	10	4	0	-2	-4	-11	-17	-24

### PKA + MBB - Supply air

### Correction sound power level ( $L_{WA}$ ) and pressure loss ( $\Delta p_t$ )

PKA + MBB		1 - ways		2 - ways		3 - ways	
duct	PKA	$L_{WA}$	$\Delta p_t$	$L_{WA}$	$\Delta p_t$	$L_{WA}$	$\Delta p_t$
100	125	+ 10	x 1.3	+ 4	x 1.1	+ 2	x 1.05
100	160	+ 5	x 1.1	+ 2	x 1.05	+ 1	x 1
125	125	+ 10	x 1,35	+ 6	x 1,1	+ 4	x 1,05
125	160	+ 10	x 1.4	+ 4	x 1.1	+ 1	x 1
125	200	+ 4	x 1.2	+ 2	x 1.05	+ 1	x 1
160	160	+ 13	x 1.8	+ 6	x 1.3	+ 2	x 1.1
160	200	+ 16	x 1.7	+ 10	x 1.2	+ 4	x 1.05
160	250	+ 10	x 1.3	+ 6	x 1,1	+ 3	x 1
200	200	+ 17	x 2.3	+ 11	x 1.4	+ 7	x 1.1
200	250	+ 13	x 1.8	+ 6	x 1.2	+ 4	x 1.1
200	315	+ 9	x 1.5	+ 4	x 1.1	+ 0	x 1.05
250	250	+ 21	x 2.1	+ 11	x 1.4	+ 7	x 1.2
250	315	+ 19	x 1.8	+ 7	x 1.2	+ 3	x 1.1
250	400	+ 10	x 1.5	+ 6	x 1.2	+ 0	x 1
315	315	+ 21	x 2.1	+ 10	x 1.3	+ 4	x 1.1
315	400	+ 21	x 1.8	+ 8	x 1.5	+ 3	x 1.2



# Perforated diffuser

# PKA

## Technical data

### PKA without box - Exhaust air

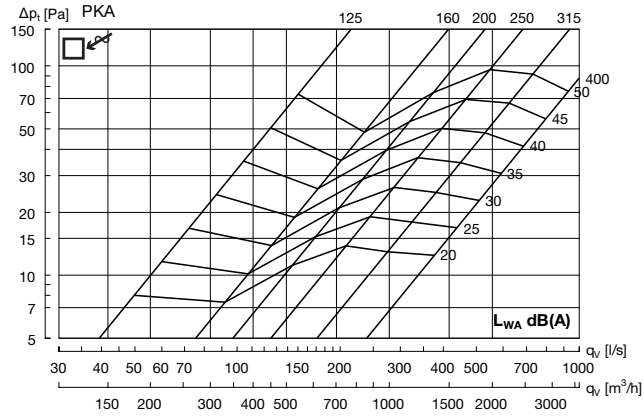

### PKA 125 + MBB - Exhaust air

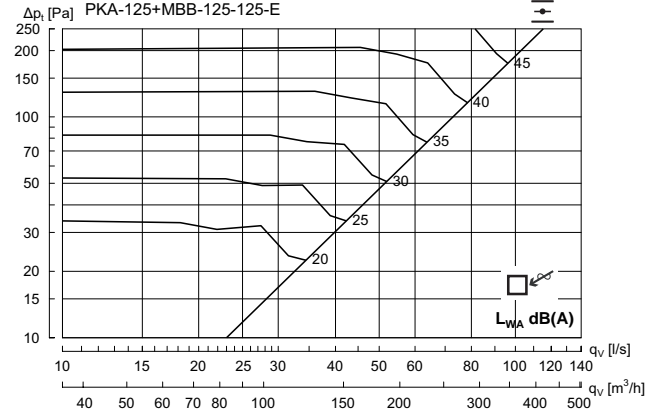

Hz	63	125	250	500	1K	2K	4K	8K
$K_{uk}$	13	5	-1	-4	-4	-11	-15	-20

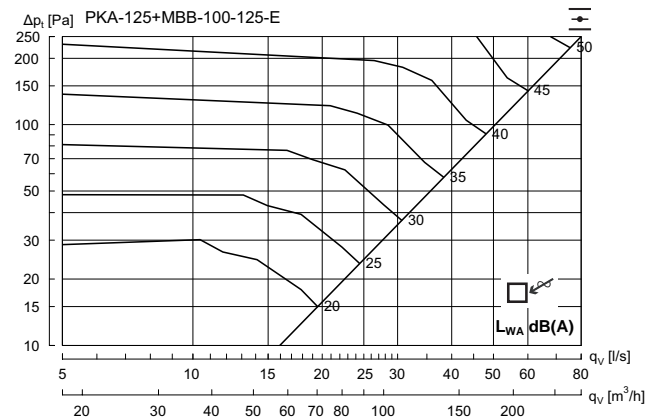

Hz	63	125	250	500	1K	2K	4K	8K
$K_{uk}$	13	-1	3	-3	-6	-10	-16	-19

- 1
- 2
- 3
- 4
- 5
- 6
- 7
- 8
- 9
- 10
- 11
- 12
- 13
- 14
- 15
- 16
- 17
- 18



# Perforated diffuser

# PKA

## Technical data

### PKA 160 + MBB - Exhaust air

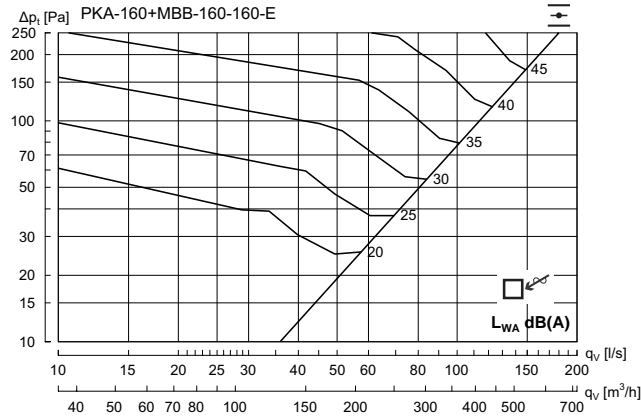

Hz	63	125	250	500	1K	2K	4K	8K
$K_{ok}$	16	6	-1	-5	-4	-10	-15	-19

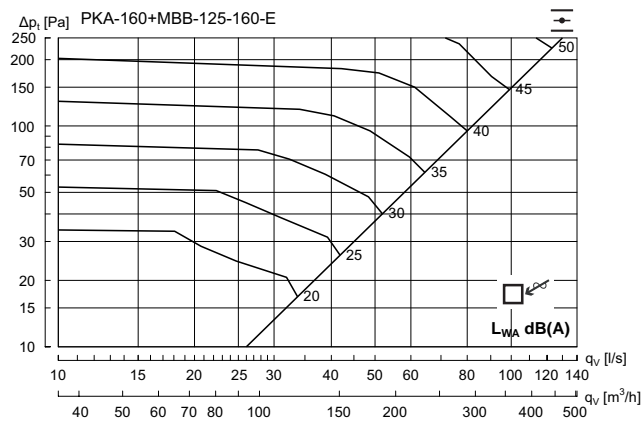

Hz	63	125	250	500	1K	2K	4K	8K
$K_{ok}$	13	5	0	-3	-5	-11	-15	-22

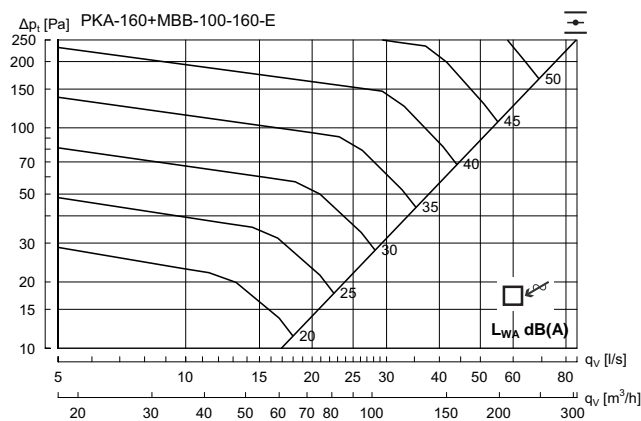

Hz	63	125	250	500	1K	2K	4K	8K
$K_{ok}$	10	-1	5	-3	-8	-11	-18	-25

### PKA 200 + MBB - Exhaust air

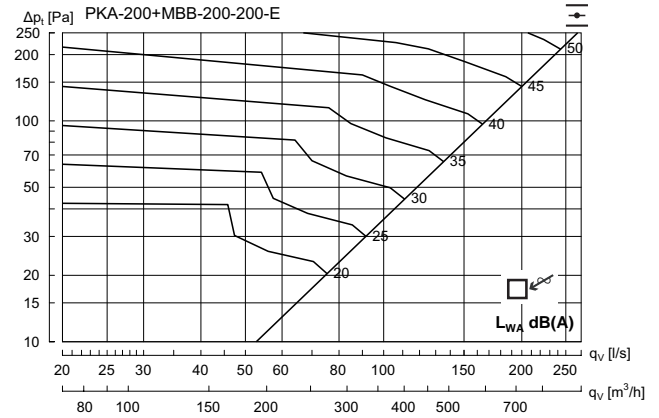

Hz	63	125	250	500	1K	2K	4K	8K
$K_{ok}$	15	4	-1	-4	-5	-9	-16	-25

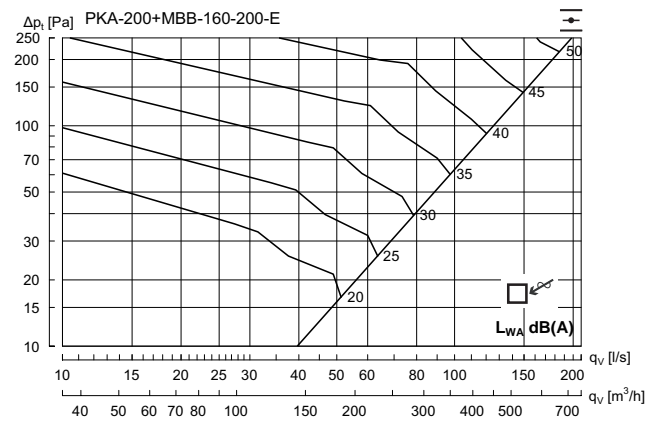

Hz	63	125	250	500	1K	2K	4K	8K
$K_{ok}$	15	6	-1	-5	-5	-9	-14	-20

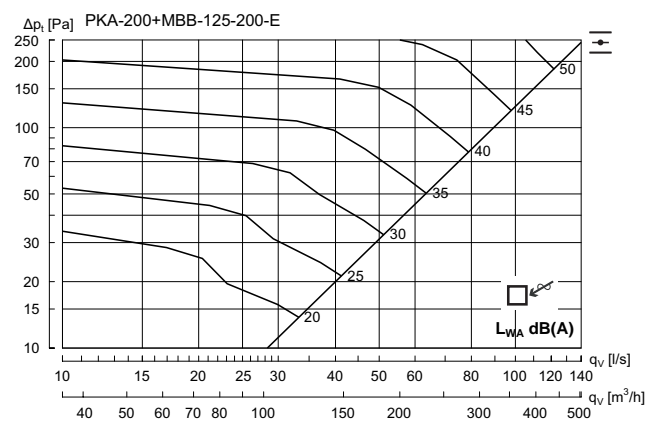

Hz	63	125	250	500	1K	2K	4K	8K
$K_{ok}$	9	3	1	-4	-5	-10	-14	-21

# Perforated diffuser

# PKA

## Technical data

### PKA 250 + MBB - Exhaust air

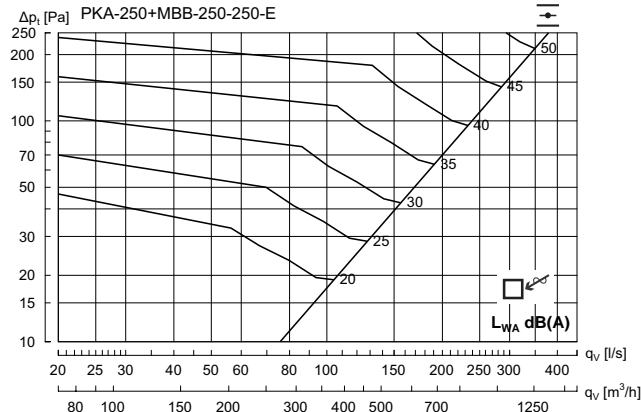

Hz	63	125	250	500	1K	2K	4K	8K
$K_{ok}$	10	5	2	-3	-5	-11	-16	-25

### PKA 315 + MBB - Exhaust air

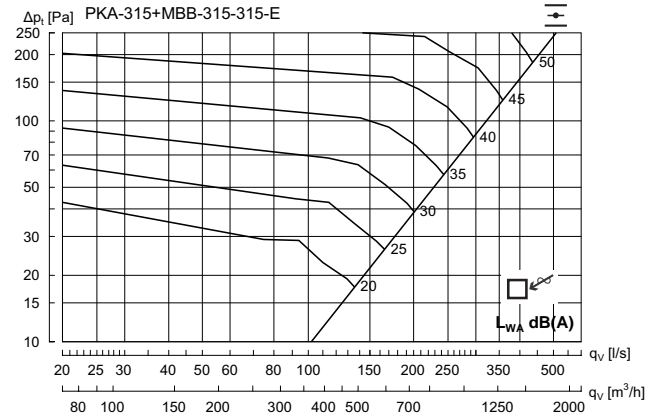

Hz	63	125	250	500	1K	2K	4K	8K
$K_{ok}$	13	5	3	-4	-6	-10	-16	-26

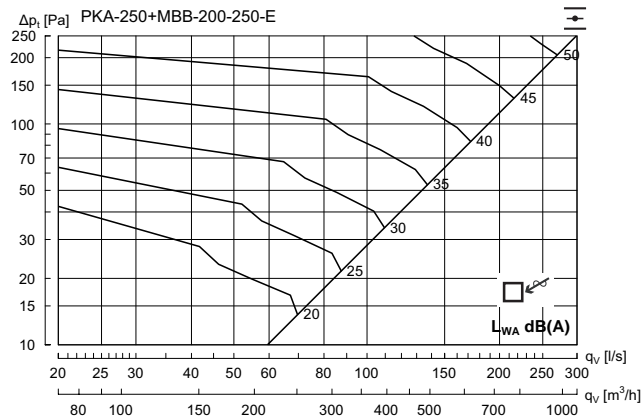

Hz	63	125	250	500	1K	2K	4K	8K
$K_{ok}$	12	5	0	-3	-5	-10	-14	-23

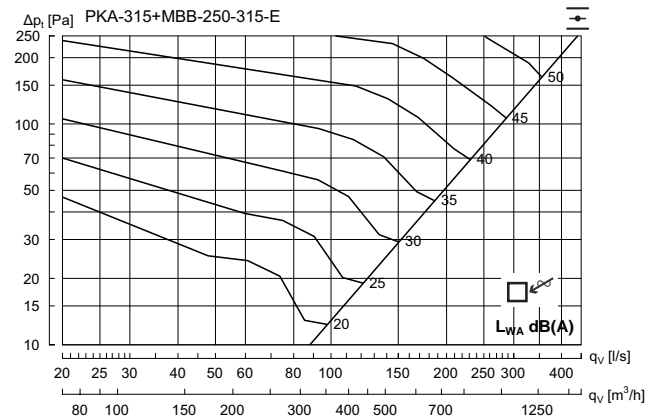

Hz	63	125	250	500	1K	2K	4K	8K
$K_{ok}$	7	5	2	-3	-6	-10	-16	-24

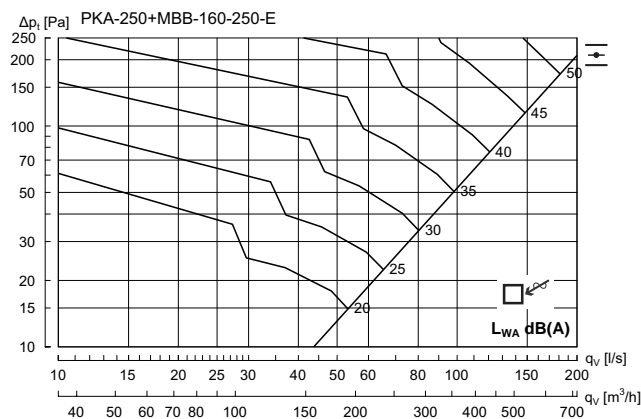

Hz	63	125	250	500	1K	2K	4K	8K
$K_{ok}$	16	6	0	-5	-5	-9	-15	-21

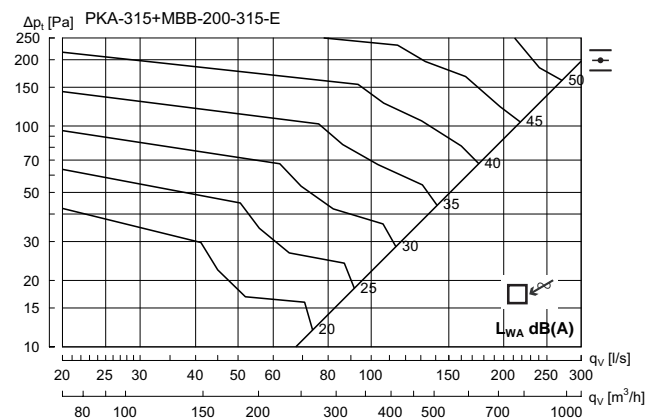

Hz	63	125	250	500	1K	2K	4K	8K
$K_{ok}$	13	5	0	-3	-5	-9	-15	-23

# Perforated diffuser

# PKA

## Technical data

### PKA 400 + MBB - Exhaust air

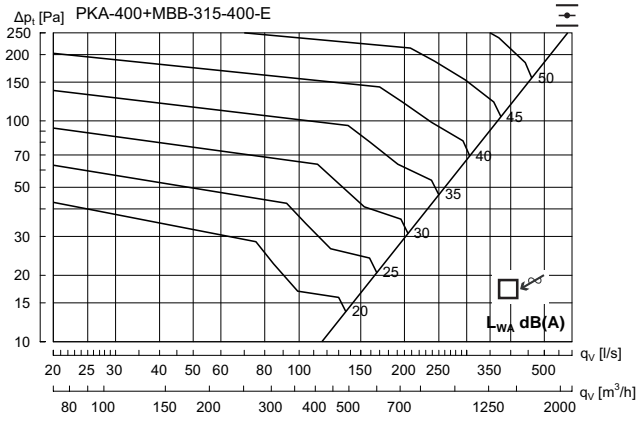

Hz	63	125	250	500	1K	2K	4K	8K
$K_{sk}$	10	4	2	-3	-6	-9	-14	-25

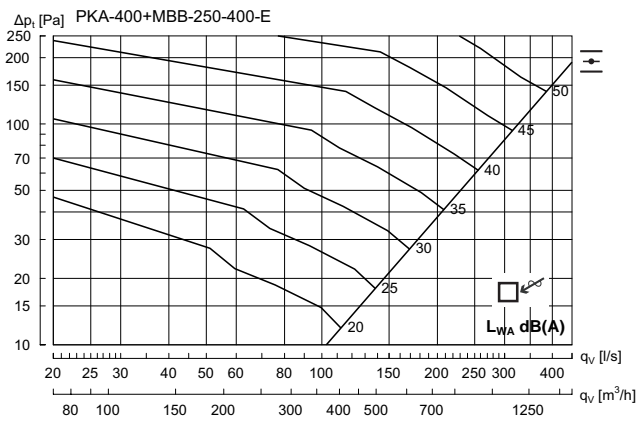

Hz	63	125	250	500	1K	2K	4K	8K
$K_{sk}$	10	5	2	-4	-5	-10	-15	-23

- 1
- 2
- 3
- 4
- 5
- 6
- 7
- 8
- 9
- 10
- 11
- 12
- 13
- 14
- 15
- 16
- 17
- 18



# Perforated diffuser

# PCA



## Description

PCA is a circular diffuser with perforated face plate. PCA can be used for both supply and exhaust air. PCA is suitable for horizontal supply of cooled air and can be equipped with accessories of various types in order to achieve optimal function. Installing a PCA diffuser in a plenum box type MBB can help to achieve a stable airflow to the diffuser as well as realise the potential for individual adjustment.

- Suitable for both supply and exhaust air
- Suitable for horizontal supply of cooled air
- Option of 1, 2 and 3-way supply air

## Maintenance

The face plate can be removed to enable cleaning of internal parts or to gain access to the duct or box. The visible parts of the diffuser can be wiped with a damp cloth.

## Dimensions

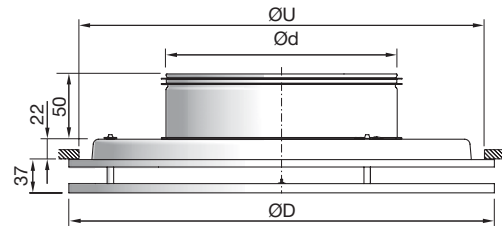

PCA Ød mm	ØD mm	ØU* mm	Free area A m <sup>2</sup>	Weight kg
100	240	200	0.016	1,00
125	240	200	0.018	1,00
160	300	260	0.023	1,50
200	360	320	0.03	2,30
250	460	420	0.042	3,40
315	540	500	0.058	4,60
400	540	500	0.066	4,60

\* ØU = Ceiling grid opening

## Order code

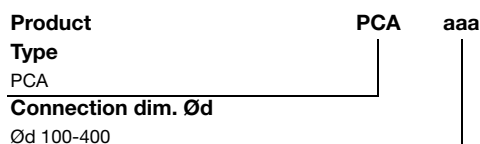

Example: PCA-200

## Materials and finish

Material: Galvanised steel  
 Standard finish: Powder-coated  
 Standard colour: White RAL 9010, gloss 30

The diffuser is available in other colours. Please contact Lindab's sales department for further information.

# Perforated diffuser

PCA

## Accessories

### DRZ - Balancing damper

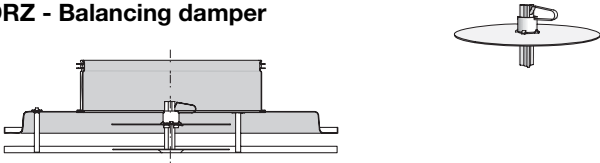

### Blending profiles (set)

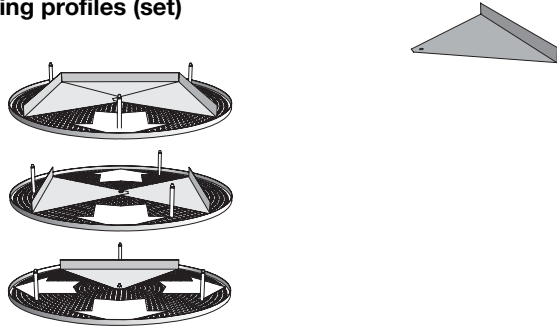

### MBZ - Extension piece

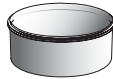

### DDZ - Mounting brackets (set)

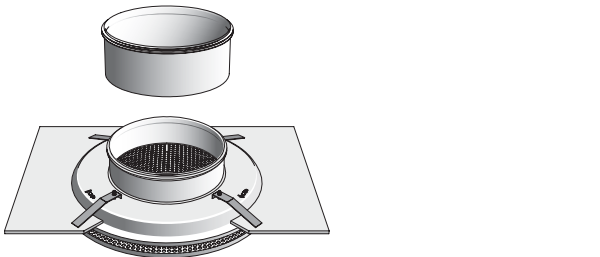

### Order code - accessories

Product aaa bbb  
 Type |  
 Size |

Example: DRZ-200

### LM - Module plate

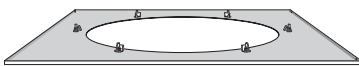

### Order code - module plate

Product LM a PCA ccc  
 Type |  
 Ceiling system |  
 Diffuser |  
 Size |

Example: LM-1-PCA-200

Ceiling system - see introductory summary.

## MBB - Plenum box



### PCA + MBB

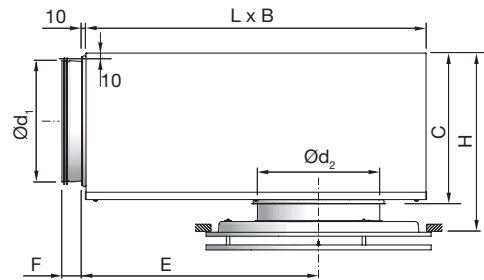

PCA + MBB		B mm	C mm	E mm	F mm	H* mm	L mm
duct Ød <sub>1</sub> mm	PCA Ød <sub>2</sub> mm						
100	100	260	159	216	50	180 - 220	310
100	125	260	159	216	50	180 - 220	310
100	160	260	159	216	50	180 - 220	310
125	125	310	184	262	50	205 - 245	376
125	160	310	184	262	50	205 - 245	376
125	200	310	184	262	50	205 - 245	376
160	160	380	220	323	50	239 - 279	459
160	200	380	220	323	50	239 - 279	459
160	250	380	220	323	50	239 - 279	459
200	200	460	259	396	70	280 - 320	565
200	250	460	259	396	70	280 - 320	565
200	315	460	259	396	70	280 - 320	565
250	250	540	309	486	70	330 - 370	698
250	315	540	309	486	70	330 - 370	698
250	400	540	309	486	70	330 - 370	698
315	315	540	373	646	70	395 - 435	858
315	400	540	373	646	70	395 - 435	858

\* Using accessory MBZ the H dimension will increase:

Ød<sub>2</sub> = 100 - 200 mm => H +40 mm

Ød<sub>2</sub> = 250 - 315 mm => H +60 mm

Ød<sub>2</sub> = 400 mm => H +80 mm

### Order code

Product MBB aaa bbb c  
 Type |  
 MBB |  
 Duct connection Ød<sub>1</sub> |  
 Ø100-315 |  
 Diffuser dimension Ød<sub>2</sub> |  
 Ø100-400 |  
 Function |  
 S = Supply air |  
 E = Exhaust |

Example: PCA-200+MBB-160-200-S

# Perforated diffuser

# PCA

## Technical data

### Capacity

Air flow  $q_v$  [l/s] and [m<sup>3</sup>/h], total pressure  $\Delta p_t$  [Pa], throw  $l_{0.2}$  [m] and sound power level  $L_{WA}$  [dB(A)] can be seen in the diagrams

### Frequency-related sound effect level

The sound effect level in the frequency band is defined as  $L_{WA} + K_{Ok}$ .  $K_{Ok}$  values are specified in charts beneath the diagrams on the following pages.

### Quick selection, supply air

PCA + MBB		$\Delta p_t \geq 50$ Pa 30 dB(A)		$\Delta p_t \geq 50$ Pa 35 dB(A)	
duct $\varnothing d_1$	PCA $\varnothing d_2$	l/s	m <sup>3</sup> /h	l/s	m <sup>3</sup> /h
100	100	26	94	31	112
100	125	33	119	39	140
100	160	39	140	47	169
125	125	40	144	48	173
125	160	51	184	61	220
125	200	58	209	70	252
160	160	57	207	71	255
160	200	67	241	84	302
160	250	77	277	99	356
200	200	83	299	100	360
200	250	96	346	118	425
200	315	112	403	139	500
250	250	118	425	139	500
250	315	133	479	163	587
250	400	146	526	193	695
315	315	145	522	173	623
315	400	187	673	225	810

### Sound attenuation

Sound attenuation of the diffuser  $\Delta L$  from duct to room, including end reflection, see table below.

PCA + MBB		Centre frequency Hz							
duct $\varnothing d_1$	PCA $\varnothing d_2$	63	125	250	500	1K	2K	4K	8K
100	100	18	17	8	20	19	20	19	23
100	125	19	16	7	19	18	18	18	21
100	160	21	16	5	15	17	18	16	19
125	125	18	13	9	20	13	19	18	19
125	160	12	13	8	19	13	16	17	19
125	200	16	11	5	16	13	15	15	17
160	160	17	17	11	19	18	17	20	20
160	200	14	14	7	21	15	16	18	19
160	250	15	15	5	17	13	15	16	18
200	200	15	10	6	16	17	15	19	18
200	250	12	9	5	14	17	15	17	17
200	315	12	7	4	11	15	14	16	15
250	250	14	8	8	14	16	17	17	18
250	315	12	6	6	15	15	15	16	17
250	400	13	5	4	13	14	14	15	15
315	315	7	9	8	14	17	16	17	21
315	400	7	8	8	12	16	16	16	18

### Balancing

Balancing data is contained in a separate brochure.

### Throw $l_{0.2}$

The throw is specified at a terminal velocity of 0.2 m/s.

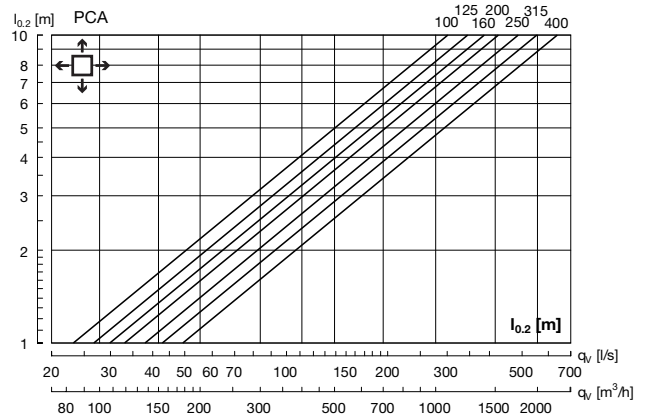

### Correction throw $L_{0.2}$

PCA $\varnothing d$	1 - ways	2 - ways	3 - ways
100	2.3	1.7	1.3
125	2.6	1.8	1.4
160	2.5	1.7	1.3
200	2.4	1.7	1.3
250	2.3	1.7	1.3
315	2.2	1.7	1.2
400	2.3	1.7	1.2

### Air jet distribution

$l_b$  = Distance from the diffuser to the point where there is maximum dispersal.

$b_v$  = Depth of the air jet on a vertical plane.

$b_h$  = Width of the air jet on a horizontal plane.

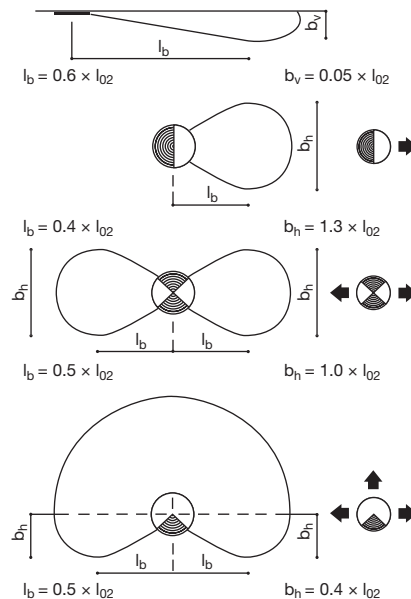

# Perforated diffuser

# PCA

## Technical data

### PCA without box - supply air

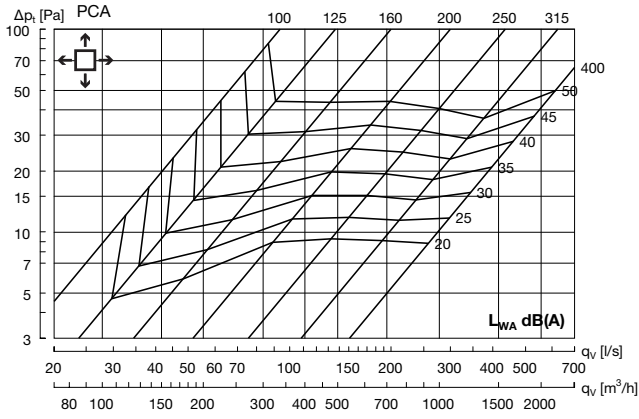

### PCA 100 + MBB - Supply air

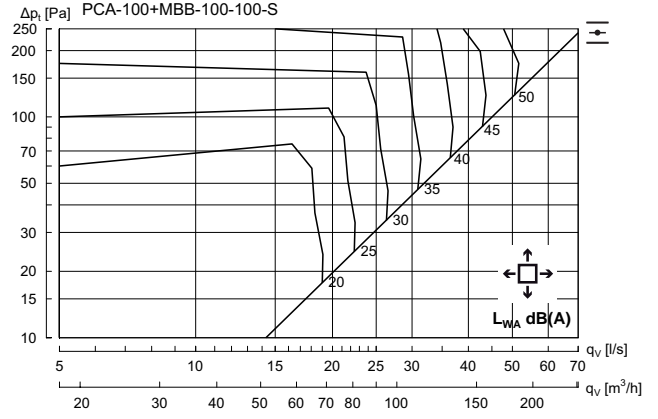

Hz	63	125	250	500	1K	2K	4K	8K
$K_{ok}$	12	5	2	-5	-4	-11	-20	-26



# Perforated diffuser

# PCA

## Technical data

### PCA 125 + MBB - Supply air

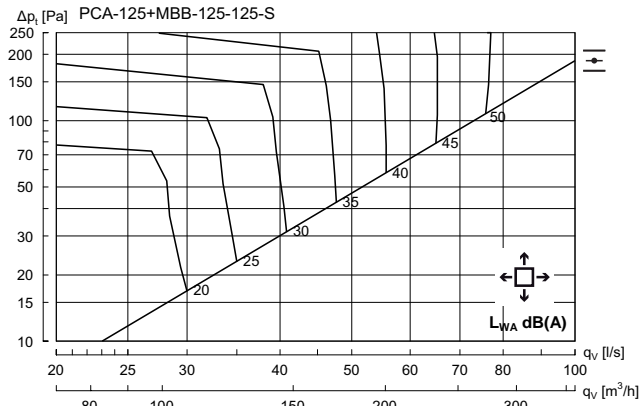

Hz	63	125	250	500	1K	2K	4K	8K
$K_{ok}$	9	5	-1	-4	-3	-11	-20	-26

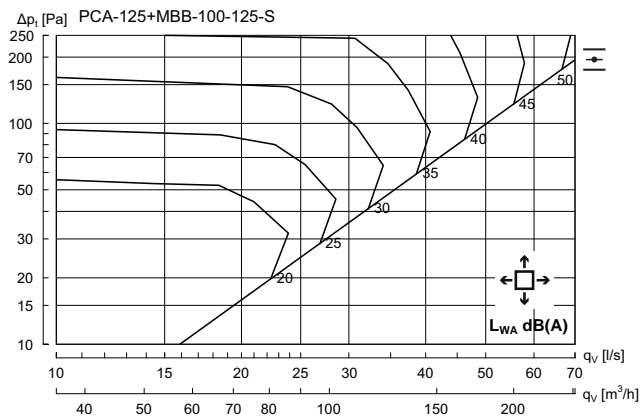

Hz	63	125	250	500	1K	2K	4K	8K
$K_{ok}$	11	7	3	-5	-5	-11	-18	-25

### PCA 160 + MBB - Supply air

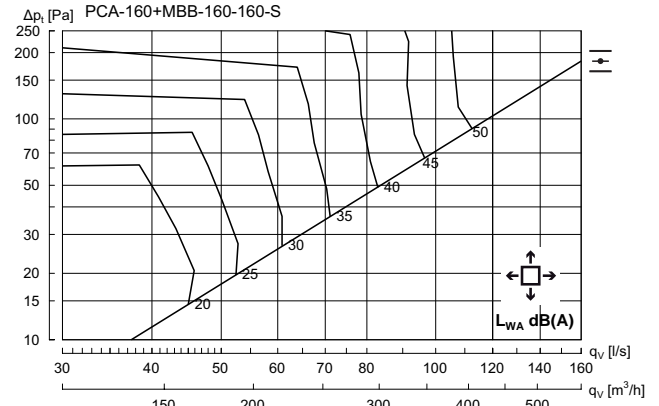

Hz	63	125	250	500	1K	2K	4K	8K
$K_{ok}$	8	5	-2	-4	-3	-11	-21	-29

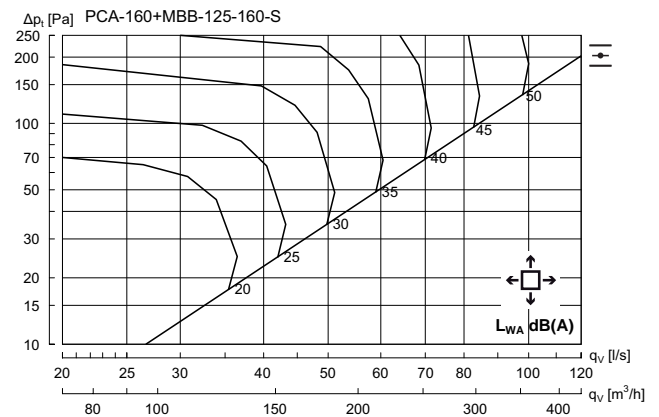

Hz	63	125	250	500	1K	2K	4K	8K
$K_{ok}$	9	5	1	-4	-4	-10	-17	-25

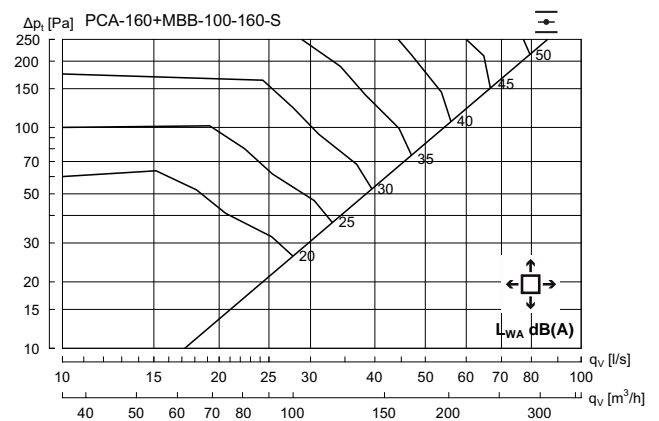

Hz	63	125	250	500	1K	2K	4K	8K
$K_{ok}$	9	4	1	-3	-5	-10	-15	-19



# Perforated diffuser

PCA

## Technical data

### PCA 200 + MBB - Supply air

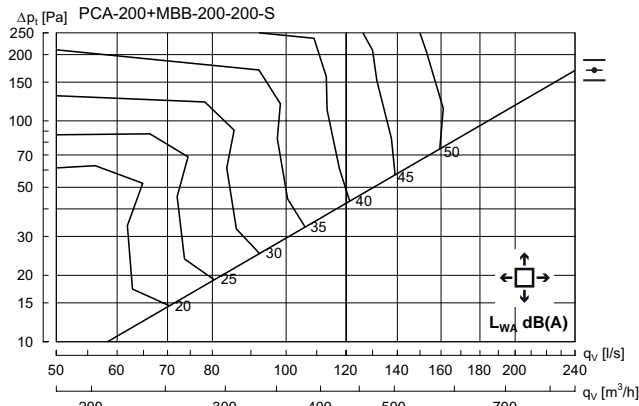

Hz	63	125	250	500	1K	2K	4K	8K
$K_{ok}$	11	5	-3	-3	-3	-11	-22	-29

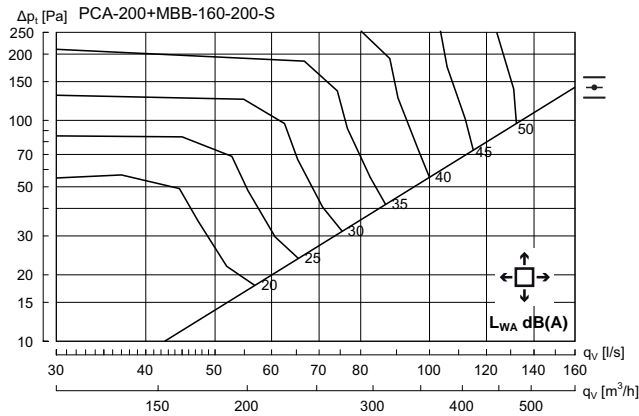

Hz	63	125	250	500	1K	2K	4K	8K
$K_{ok}$	10	5	-2	-4	-3	-10	-20	-26

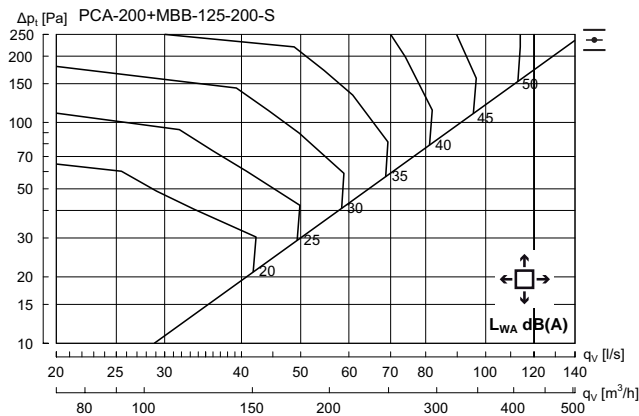

Hz	63	125	250	500	1K	2K	4K	8K
$K_{ok}$	10	5	1	-4	-5	-10	-15	-22

### PCA 250 + MBB - Supply air

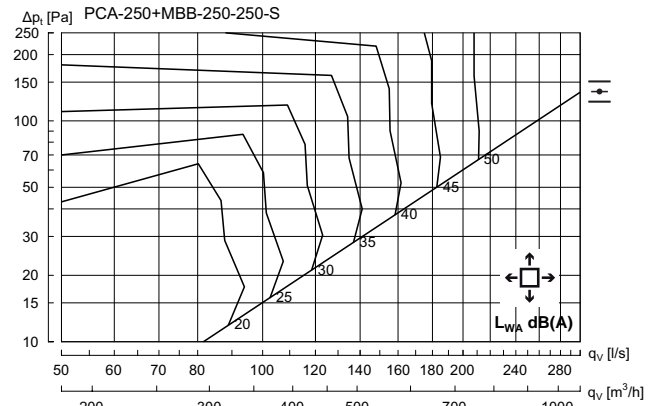

Hz	63	125	250	500	1K	2K	4K	8K
$K_{ok}$	11	3	-4	-3	-3	-12	-22	-30

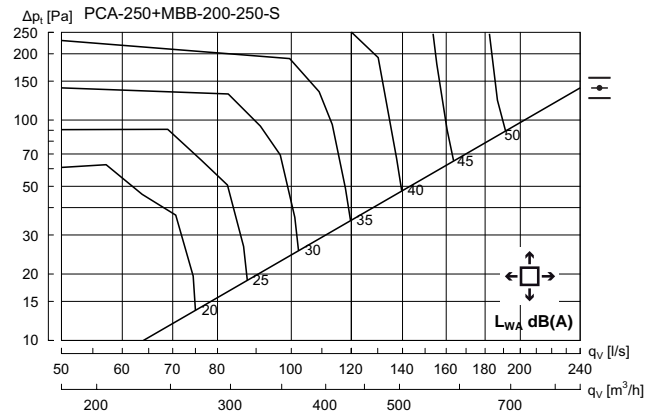

Hz	63	125	250	500	1K	2K	4K	8K
$K_{ok}$	10	5	-2	-3	-3	-11	-20	-28

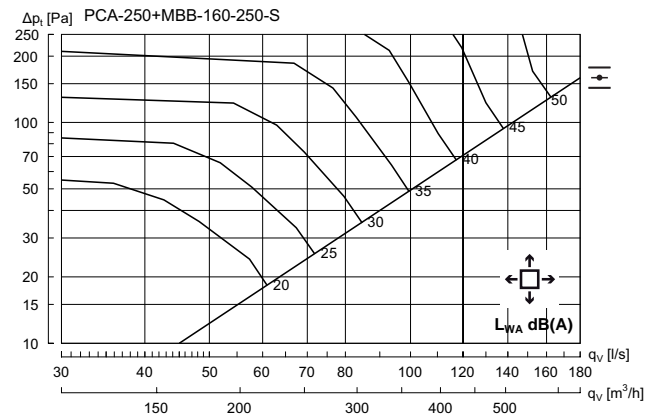

Hz	63	125	250	500	1K	2K	4K	8K
$K_{ok}$	8	5	0	-4	-4	-10	-17	-23

# Perforated diffuser

# PCA

## Technical data

### PCA 315 + MBB - Supply air

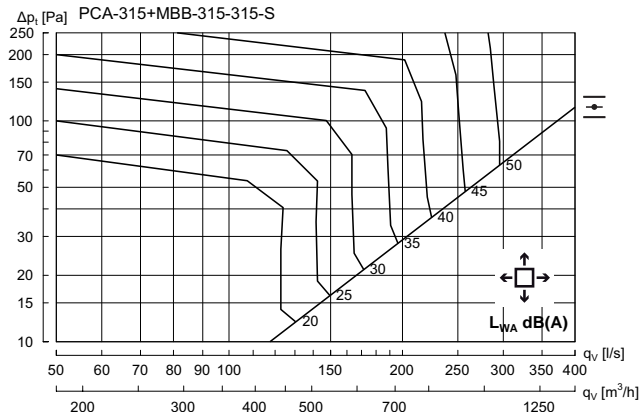

Hz	63	125	250	500	1K	2K	4K	8K
$K_{ok}$	12	2	-3	-2	-3	-13	-23	-33

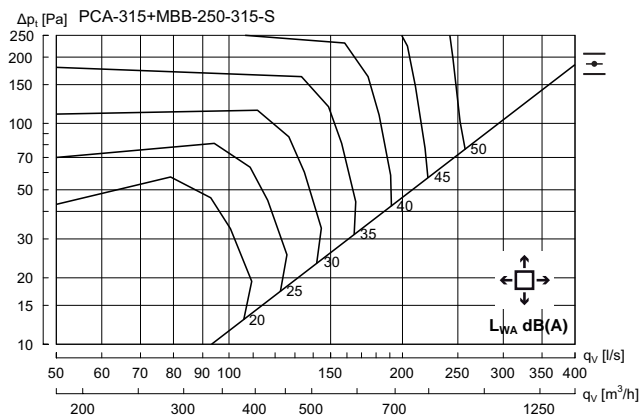

Hz	63	125	250	500	1K	2K	4K	8K
$K_{ok}$	11	3	-2	-3	-4	-11	-18	-27

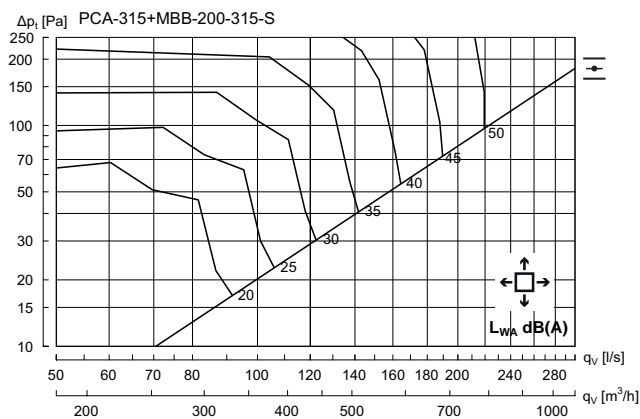

Hz	63	125	250	500	1K	2K	4K	8K
$K_{ok}$	10	5	-1	-3	-4	-11	-19	-25

### PCA 400 + MBB - Supply air

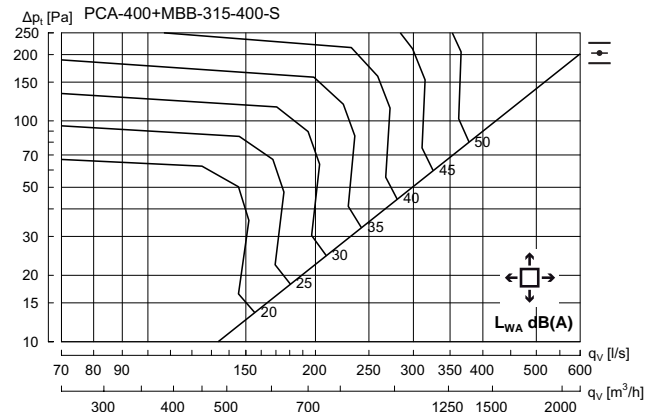

Hz	63	125	250	500	1K	2K	4K	8K
$K_{ok}$	14	2	0	-2	-5	-13	-17	-26

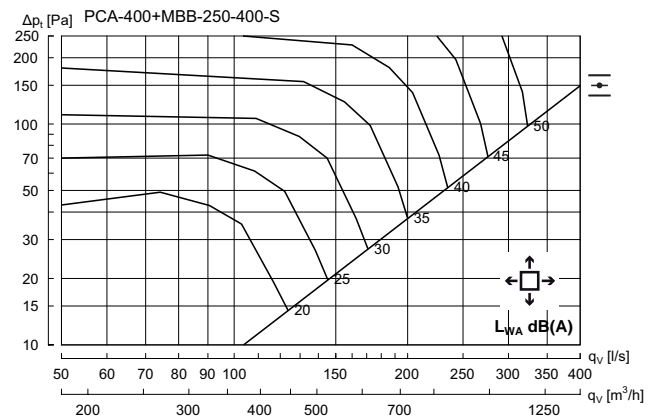

Hz	63	125	250	500	1K	2K	4K	8K
$K_{ok}$	10	4	0	-2	-4	-11	-17	-24

### Correction sound power level ( $L_{WA}$ ) and pressure loss ( $\Delta P_t$ )

PCA + MBB		1 - ways		2 - ways		3 - ways	
duct	PCA	$L_{WA}$	$\Delta P_t$	$L_{WA}$	$\Delta P_t$	$L_{WA}$	$\Delta P_t$
$\varnothing d_1$	$\varnothing d_2$						
100	100	+ 10	x 1,35	+ 6	x 1,1	+ 4	x 1,05
100	125	+ 10	x 1,3	+ 4	x 1,1	+ 2	x 1,05
100	160	+ 5	x 1,1	+ 2	x 1,05	+ 1	x 1
125	125	+ 10	x 1,35	+ 6	x 1,1	+ 4	x 1,05
125	160	+ 10	x 1,4	+ 4	x 1,1	+ 1	x 1
125	200	+ 4	x 1,2	+ 2	x 1,05	+ 1	x 1
160	160	+ 13	x 1,8	+ 6	x 1,3	+ 2	x 1,1
160	200	+ 16	x 1,7	+ 10	x 1,2	+ 4	x 1,05
160	250	+ 10	x 1,3	+ 6	x 1,1	+ 3	x 1
200	200	+ 17	x 2,3	+ 11	x 1,4	+ 7	x 1,1
200	250	+ 13	x 1,8	+ 6	x 1,2	+ 4	x 1,1
200	315	+ 9	x 1,5	+ 4	x 1,1	+ 0	x 1,05
250	250	+ 21	x 2,1	+ 11	x 1,4	+ 7	x 1,2
250	315	+ 19	x 1,8	+ 7	x 1,2	+ 3	x 1,1
250	400	+ 10	x 1,5	+ 6	x 1,2	+ 0	x 1
315	315	+ 21	x 2,1	+ 10	x 1,3	+ 4	x 1,1
315	400	+ 21	x 1,8	+ 8	x 1,5	+ 3	x 1,2

# Perforated diffuser

# PCA

## Technical data

### PCA without box - Exhaust air

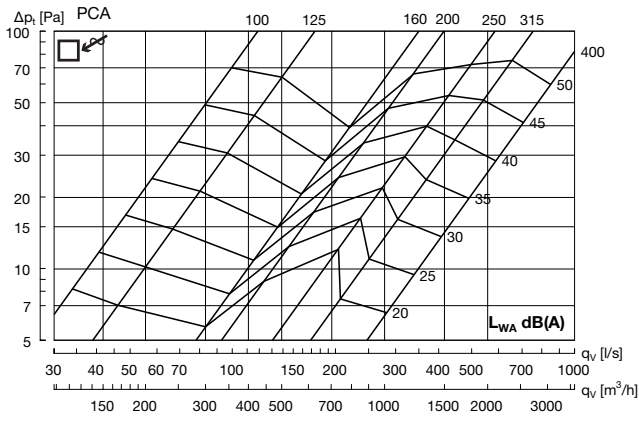

### PCA 100 + MBB - Exhaust air

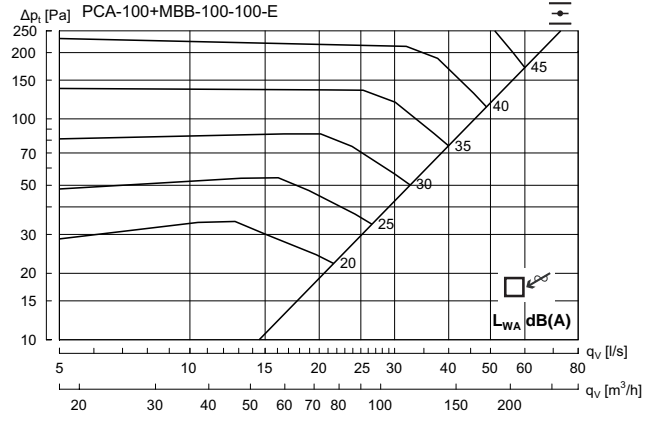

Hz	63	125	250	500	1K	2K	4K	8K
$K_{ok}$	11	0	3	-3	-6	-10	-15	-22

- 1
- 2
- 3
- 4
- 5
- 6
- 7
- 8
- 9
- 10
- 11
- 12
- 13
- 14
- 15
- 16
- 17
- 18

# Perforated diffuser

# PCA

## Technical data

### PCA 125 + MBB - Exhaust air

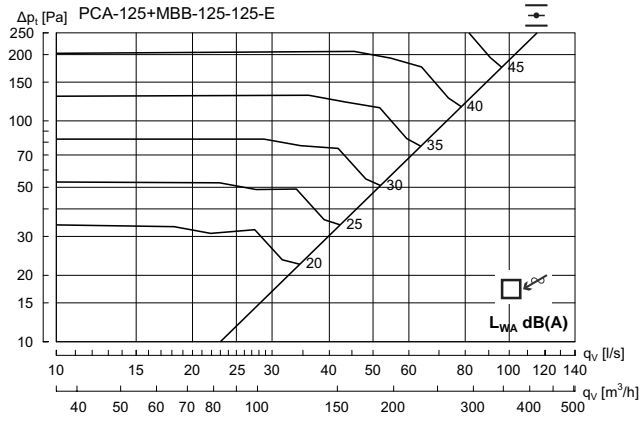

Hz	63	125	250	500	1K	2K	4K	8K
$K_{ok}$	13	5	-1	-4	-4	-11	-15	-20

### PCA 160 + MBB - Exhaust air

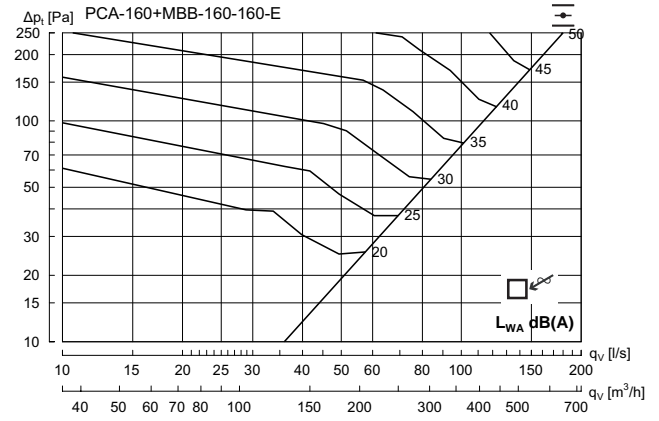

Hz	63	125	250	500	1K	2K	4K	8K
$K_{ok}$	16	6	-1	-5	-4	-10	-15	-19

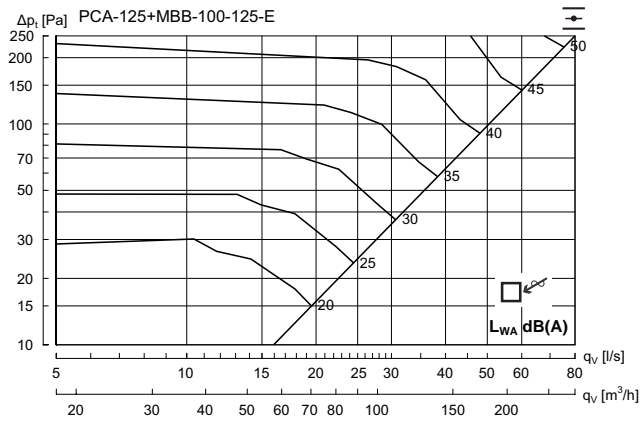

Hz	63	125	250	500	1K	2K	4K	8K
$K_{ok}$	13	-1	3	-3	-6	-10	-16	-19

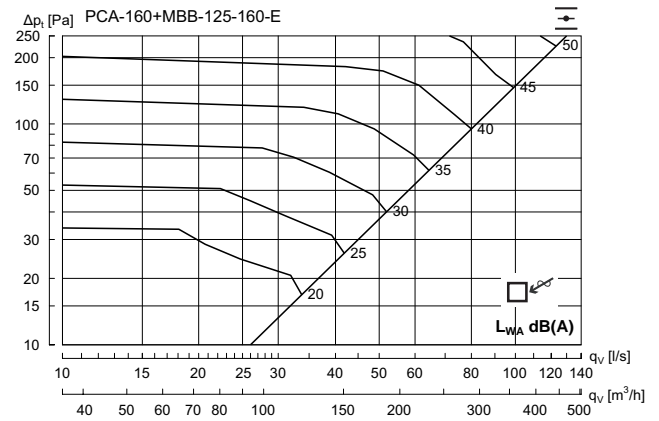

Hz	63	125	250	500	1K	2K	4K	8K
$K_{ok}$	13	5	0	-3	-5	-11	-15	-22

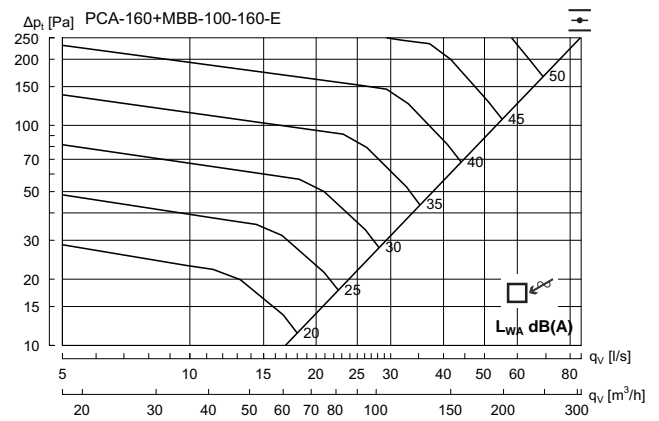

Hz	63	125	250	500	1K	2K	4K	8K
$K_{ok}$	10	-1	5	-3	-8	-11	-18	-25



# Perforated diffuser

PCA

## Technical data

### PCA 200 + MBB - Exhaust air

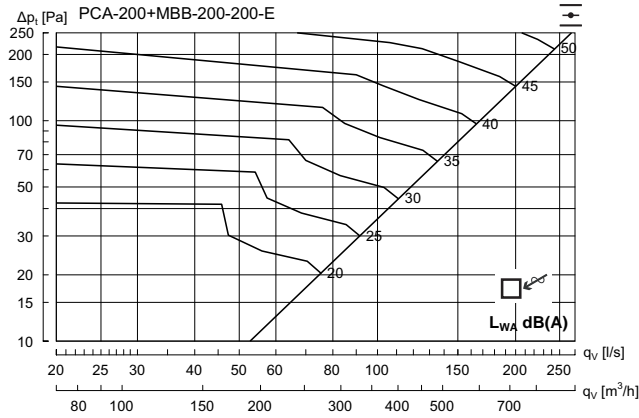

Hz	63	125	250	500	1K	2K	4K	8K
$K_{sk}$	15	4	-1	-4	-5	-9	-16	-25

### PCA 250 + MBB - Exhaust air

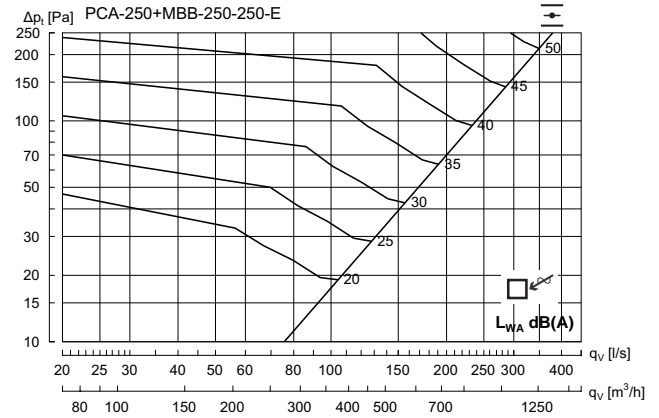

Hz	63	125	250	500	1K	2K	4K	8K
$K_{sk}$	10	5	2	-3	-5	-11	-16	-25

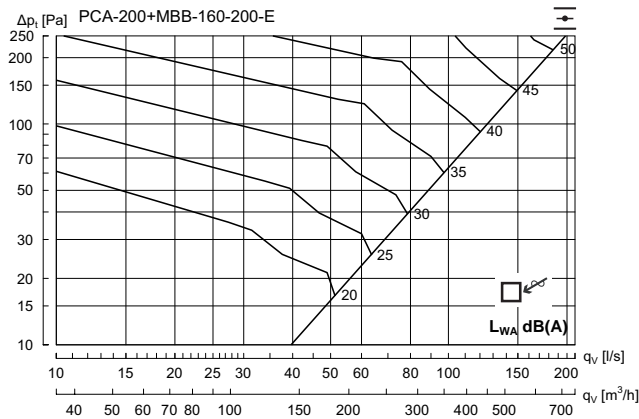

Hz	63	125	250	500	1K	2K	4K	8K
$K_{sk}$	15	6	-1	-5	-5	-9	-14	-20

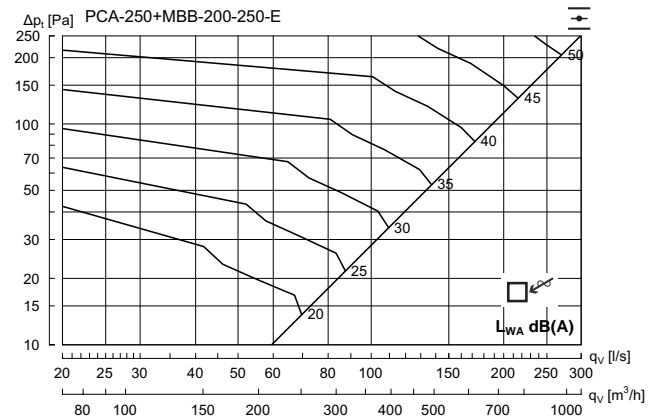

Hz	63	125	250	500	1K	2K	4K	8K
$K_{sk}$	12	5	0	-3	-5	-10	-14	-23

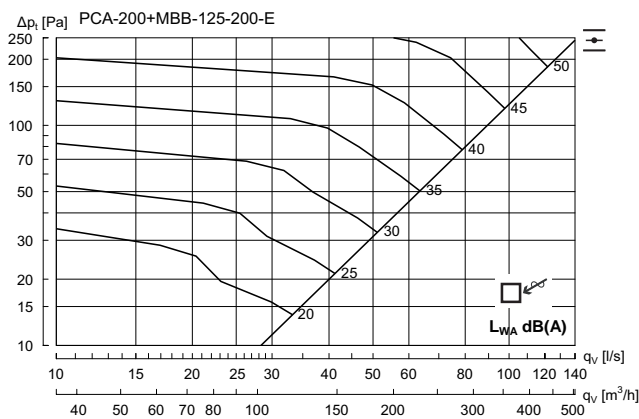

Hz	63	125	250	500	1K	2K	4K	8K
$K_{sk}$	9	3	1	-4	-5	-10	-14	-21

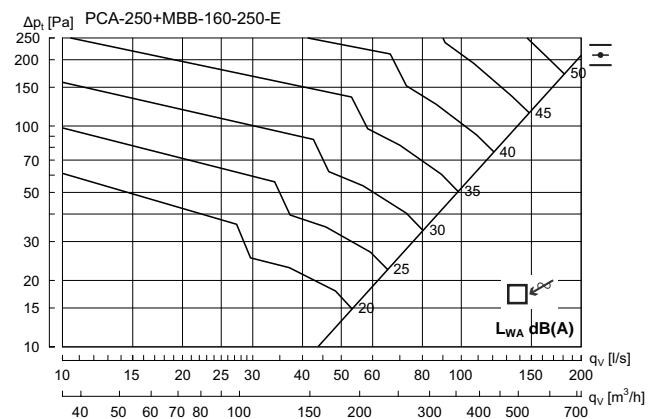

Hz	63	125	250	500	1K	2K	4K	8K
$K_{sk}$	16	6	0	-5	-5	-9	-15	-21

# Perforated diffuser

# PCA

## Technical data

### PCA 315 + MBB - Exhaust air

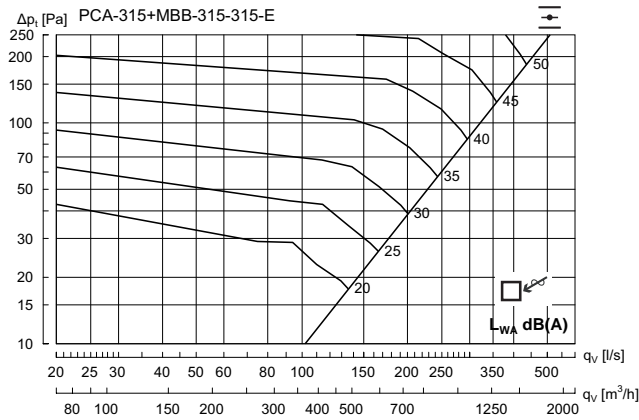

Hz	63	125	250	500	1K	2K	4K	8K
$K_{sk}$	13	5	3	-4	-6	-10	-16	-26

### PCA 400 + MBB - Exhaust air

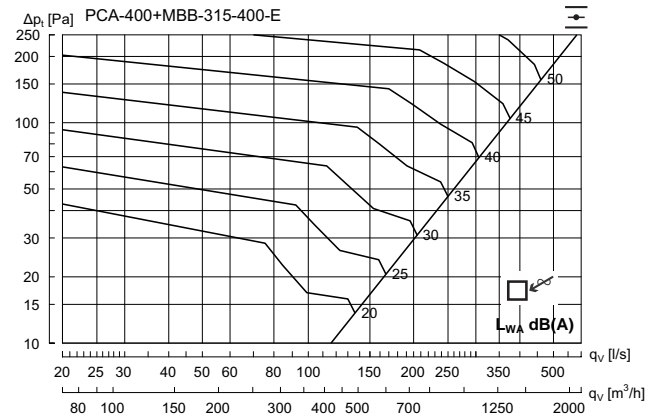

Hz	63	125	250	500	1K	2K	4K	8K
$K_{sk}$	10	4	2	-3	-6	-9	-14	-25

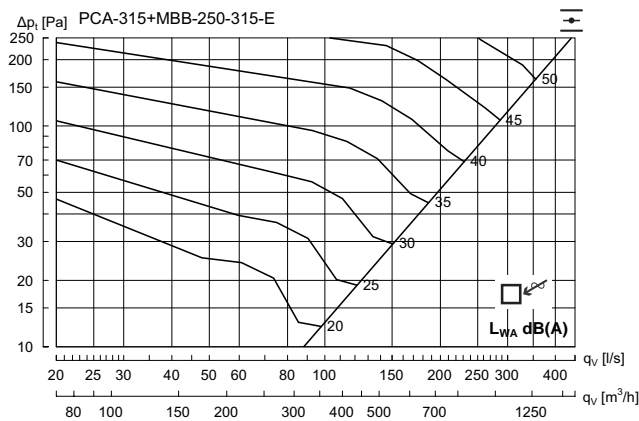

Hz	63	125	250	500	1K	2K	4K	8K
$K_{sk}$	7	5	2	-3	-6	-10	-16	-24

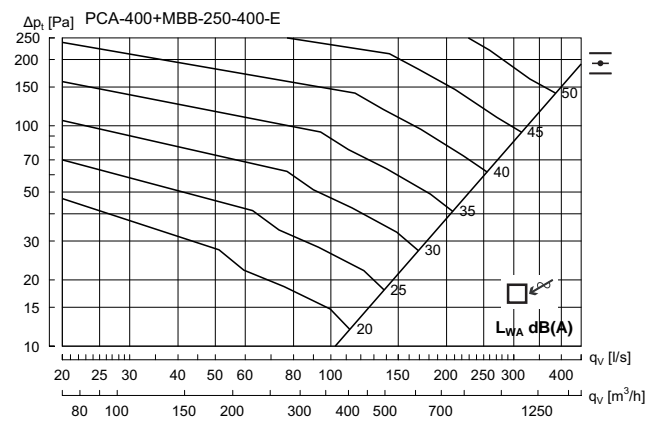

Hz	63	125	250	500	1K	2K	4K	8K
$K_{sk}$	10	5	2	-4	-5	-10	-15	-23

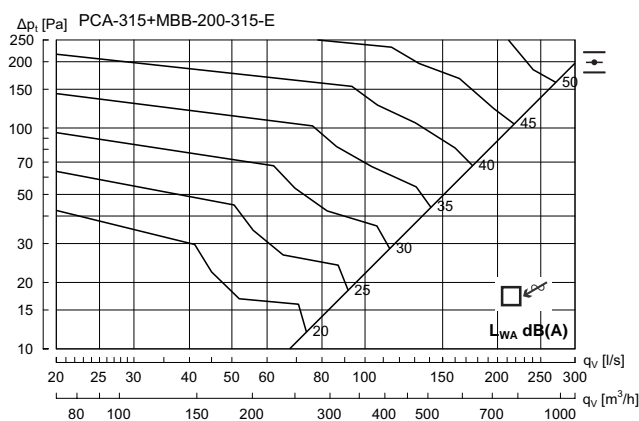

Hz	63	125	250	500	1K	2K	4K	8K
$K_{sk}$	13	5	0	-3	-5	-9	-15	-23







# Plain diffuser

# LKA



## Description

LKA is a square diffuser with an unperforated face plate that can be used for both supply and exhaust air. LKA is suitable for the horizontal supply of cooled air where a high impulse is required. It can be equipped with accessories of various types. Installing an LKA diffuser in a plenum box type MBB can help to achieve a stable airflow to the diffuser as well as realise the potential for individual adjustment.

- Suitable for both supply and exhaust air
- Suitable for the horizontal supply of cooled air
- High impulse
- Option of 1, 2 and 3-way supply air

## Maintenance

The face plate can be removed to enable cleaning of internal parts or to gain access to the duct or box. The visible parts of the diffuser can be wiped with a damp cloth.

## Order code

<b>Product Type</b> LKA	<b>LKA</b>	<b>aaa</b>
<b>Connection dim. Ød</b> Ød 125-400		

Example: LKA-200

## Dimensions

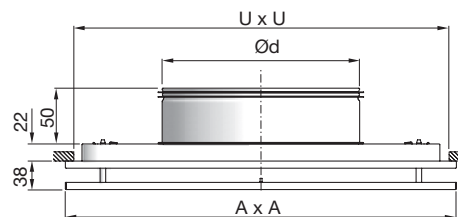

LKA Ød mm	A mm	U* mm	Free area A m <sup>2</sup>	Weight kg
125	235	200	0,011	1,10
160	295	260	0,016	1,80
200	395	360	0,022	2,80
250	495	460	0,033	4,20
315	595	560	0,041	5,70
400	595	560	0,042	5,70

\* U x U = Ceiling grid opening

## Materials and finish:

Material:	Galvanised steel
Standard finish:	Powder-coated
Standard colour:	White RAL 9010, gloss 30

The diffuser is available in other colours. Please contact Lindab's sales department for further information.

# Plain diffuser

LKA

## Accessories

### DRZ - Balancing damper

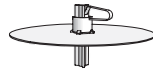
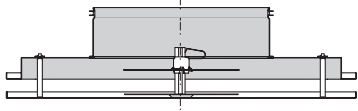

### Blending profiles (set)

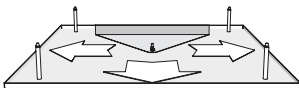
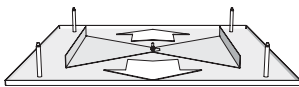
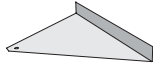
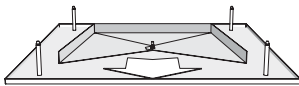

### MBZ - Extension piece

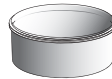

### DKZ - Mounting brackets (set)

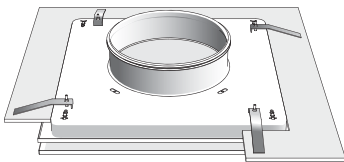
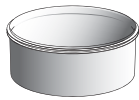

### Order code - accessories

Product                   aaa       bbb  
 Type                       |           |  
 Size                       |           |

Example: DRZ-200

### LM - Module plate



### Order code - module plate

Product                   LM       a       LKA       ccc  
 Type                       |           |           |  
 Ceiling system           |           |           |  
 Diffuser                   |           |           |  
 Size                       |           |           |

Example: LM-1-LKA-200

Ceiling system - see introductory summary.

## MBB - Plenum box



### LKA + MBB

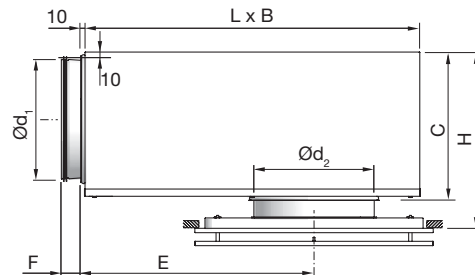

LKA + MBB		B	C	E	F	H*	L
duct	LKA	mm	mm	mm	mm	mm	mm
Ød <sub>1</sub> mm	Ød <sub>2</sub> mm						
100	125	260	159	216	50	180 - 220	310
100	160	260	159	216	50	180 - 220	310
125	125	310	184	262	50	205 - 245	376
125	160	310	184	262	50	205 - 245	376
125	200	310	184	262	50	205 - 245	376
160	160	380	220	323	50	239 - 279	459
160	200	380	220	323	50	239 - 279	459
160	250	380	220	323	50	239 - 279	459
200	200	460	259	396	70	280 - 320	565
200	250	460	259	396	70	280 - 320	565
200	315	460	259	396	70	280 - 320	565
250	250	540	309	486	70	330 - 370	698
250	315	540	309	486	70	330 - 370	698
250	400	540	309	486	70	330 - 370	698
315	315	540	373	646	70	395 - 435	858
315	400	540	373	646	70	395 - 435	858

\* Using accessory MBZ the H dimension will increase:

Ød<sub>2</sub> = 125 - 200 mm => H +40 mm

Ød<sub>2</sub> = 250 - 315 mm => H +60 mm

Ød<sub>2</sub> = 400 mm => H +80 mm

### Order code

Product                   MBB       aaa       bbb       c  
 Type                       |           |           |  
 MBB                       |           |           |  
 Duct connection Ød<sub>1</sub>       |           |           |  
 Ø100-315                   |           |           |  
 Diffuser dimension Ød<sub>2</sub>   |           |           |  
 Ø125-400                   |           |           |  
 Function                   |           |           |  
 S = Supply air           |           |           |  
 E = Exhaust               |           |           |

Example: LKA-200+MBB-160-200-S

# Plain diffuser

# LKA

## Technical data

### Capacity

Air flow  $q_v$  [l/s] and [m<sup>3</sup>/h], total pressure  $\Delta p_t$  [Pa], throw  $l_{0,2}$  [m] and sound power level  $L_{WA}$  [dB(A)] can be seen in the diagrams.

### Frequency-related sound effect level

The sound effect level in the frequency band is defined as  $L_{WA} + K_{OK}$ .  $K_{OK}$  values are specified in chart beneath the diagrams on the following pages.

### Quick selection, supply air

LKA + MBB		$\Delta p_t \geq 50$ Pa		$\Delta p_t \geq 50$ Pa	
duct	LKA	30 dB(A)		35 dB(A)	
$\text{Ø}d_1$	$\text{Ø}d_2$	l/s	m <sup>3</sup> /h	l/s	m <sup>3</sup> /h
100	125	31	112	38	137
100	160	40	144	49	176
125	125	42	151	50	180
125	160	53	191	64	230
125	200	63	227	75	270
160	160	60	216	73	263
160	200	70	252	88	317
160	250	94	338	115	414
200	200	98	353	118	425
200	250	106	382	129	464
200	315	133	479	159	572
250	250	116	418	141	508
250	315	136	490	167	601
250	400	139	500	182	655
315	315	153	551	183	659
315	400	169	608	200	720

### Sound attenuation

Sound attenuation of the diffuser  $\Delta L$  from duct to room, including end reflection, see table below

LKA + MBB		Centre frequency Hz							
duct	LKA	63	125	250	500	1K	2K	4K	8K
$\text{Ø}d_1$	$\text{Ø}d_2$								
100	125	20	17	6	16	19	20	18	22
100	160	21	17	5	12	19	20	18	21
125	125	17	14	9	19	15	21	18	20
125	160	13	13	9	18	18	18	18	20
125	200	14	12	7	15	16	18	17	19
160	160	18	17	11	16	21	19	20	21
160	200	15	14	9	20	21	20	20	20
160	250	16	16	7	17	13	18	19	20
200	200	14	11	8	15	21	18	20	18
200	250	13	10	8	16	20	17	19	17
200	315	15	9	6	14	17	17	18	17
250	250	16	9	9	17	20	19	19	19
250	315	15	8	9	16	18	16	18	18
250	400	13	6	6	14	16	17	17	17
315	315	8	10	10	16	20	19	18	23
315	400	8	10	10	13	19	19	17	21

### Balancing

Balancing data is contained in a separate brochure.

### Throw $l_{0,2}$

The throw is specified at a terminal velocity of 0.2 m/s.

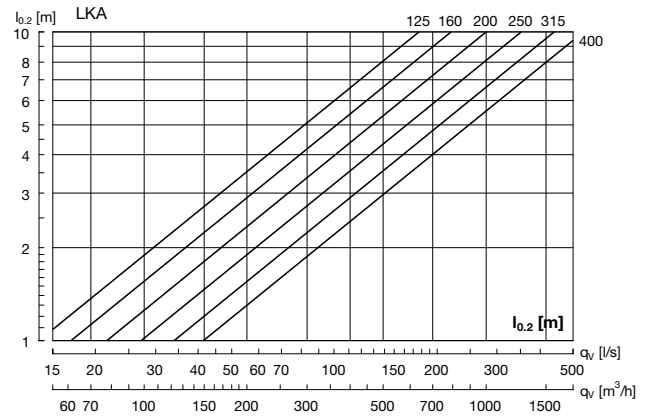

### Correction throw $L_{0,2}$

LKA Ød	1 - ways	2 - ways	3 - ways
125	2.3	1.8	1.3
160	2.3	1.8	1.3
200	2.3	1.9	1.3
250	2.3	2	1.3
315	2.3	2	1.3
400	2.2	2.1	1.3

### Air jet distribution

$l_b$  = Distance from the diffuser to the point where there is maximum dispersal.

$b_v$  = Depth of the air jet on a vertical plane.

$b_h$  = Width of the air jet on a horizontal plane.

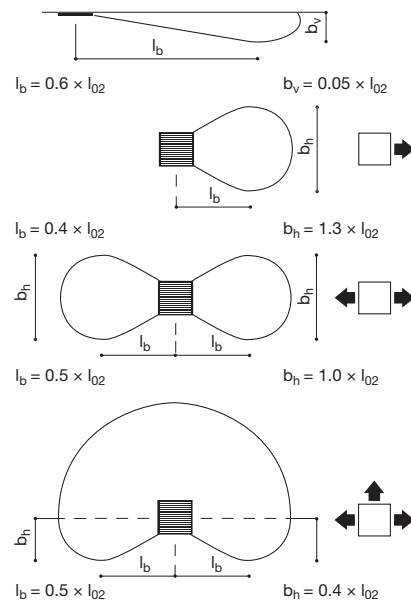

# Plain diffuser

LKA

## Technical data

### LKA without box - Supply air

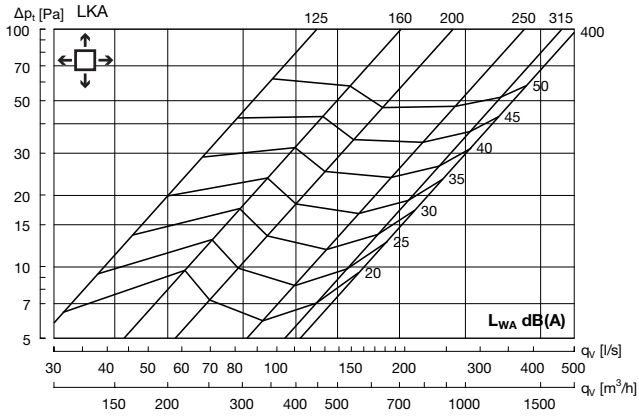

### LKA 125 + MBB - Supply air

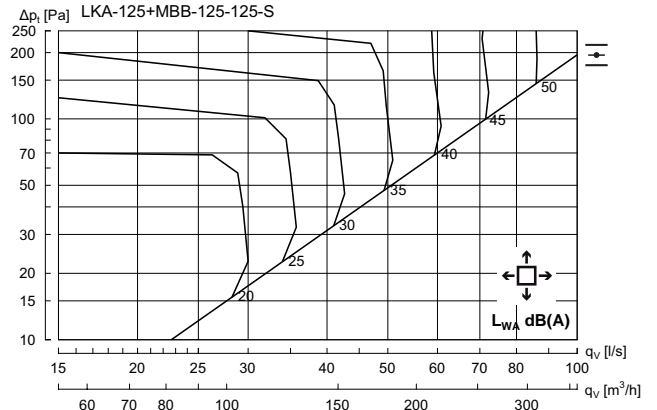

Hz	63	125	250	500	1K	2K	4K	8K
$K_{uk}$	12	6	1	-4	-4	-13	-20	-28

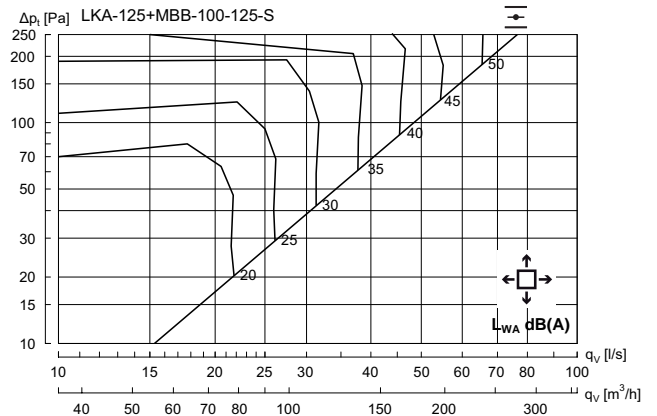

Hz	63	125	250	500	1K	2K	4K	8K
$K_{uk}$	11	7	3	-4	-5	-14	-18	-24

1

2

3

4

5

6

7

8

9

10

11

12

13

14

15

16

17

18

# Plain diffuser

# LKA

## Technical data

### LKA 160 + MBB - Supply air

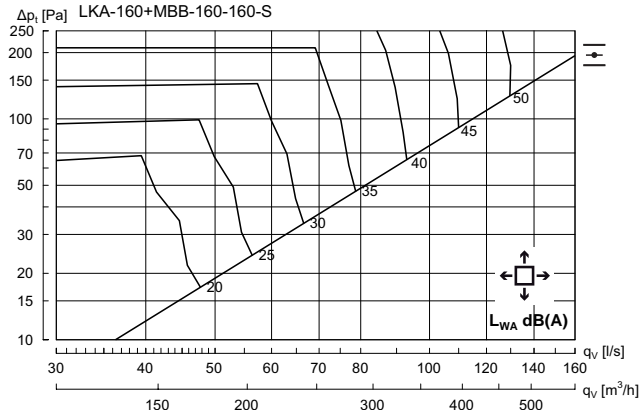

Hz	63	125	250	500	1K	2K	4K	8K
$K_{ok}$	11	11	0	-2	-7	-15	-22	-28

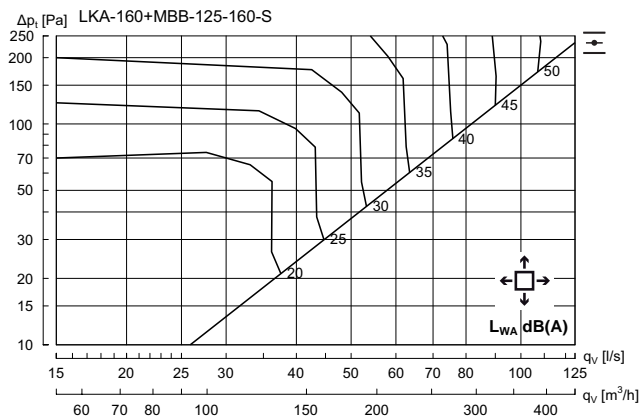

Hz	63	125	250	500	1K	2K	4K	8K
$K_{ok}$	13	8	1	-3	-6	-12	-17	-25

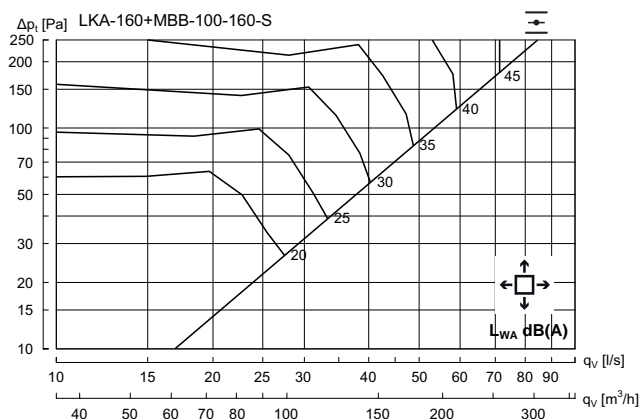

Hz	63	125	250	500	1K	2K	4K	8K
$K_{ok}$	12	5	1	-2	-6	-10	-14	-20

### LKA 200 + MBB - Supply air

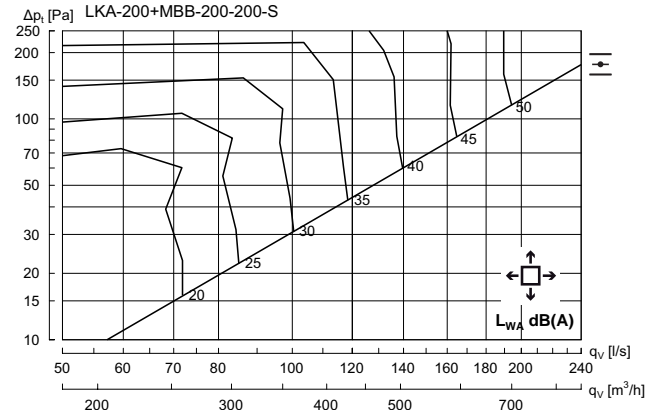

Hz	63	125	250	500	1K	2K	4K	8K
$K_{ok}$	12	6	-1	-1	-5	-15	-21	-26

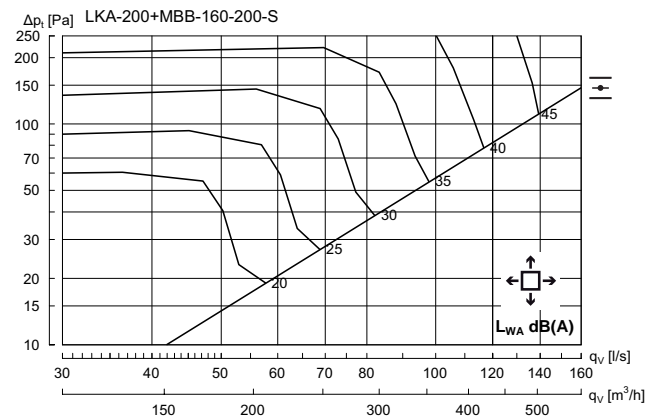

Hz	63	125	250	500	1K	2K	4K	8K
$K_{ok}$	12	9	0	-2	-6	-12	-19	-24

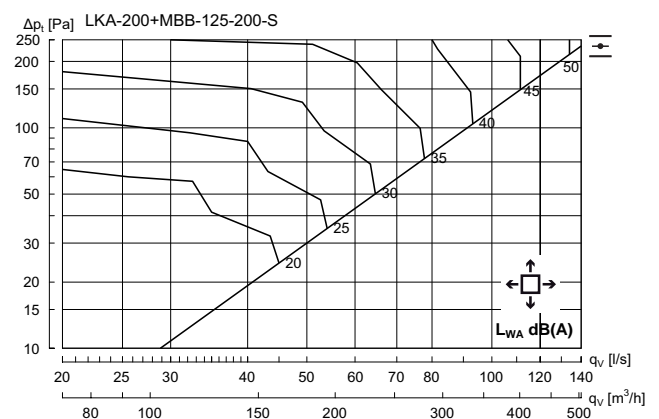

Hz	63	125	250	500	1K	2K	4K	8K
$K_{ok}$	12	7	1	-3	-6	-11	-15	-21

# Plain diffuser

# LKA

## Technical data

### LKA 250 + MBB - Supply air

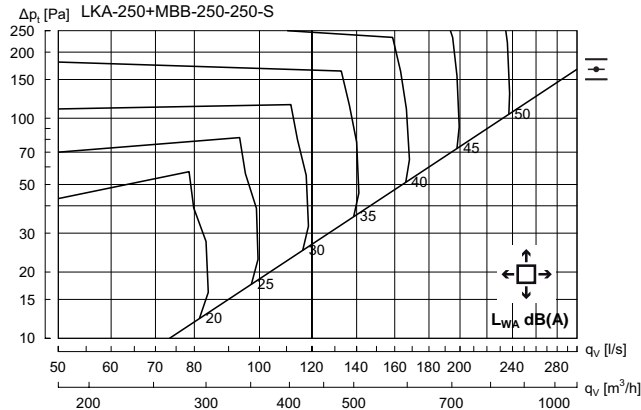

Hz	63	125	250	500	1K	2K	4K	8K
$K_{ok}$	12	3	-4	0	-4	-17	-24	-31

### LKA 315 + MBB - Supply air

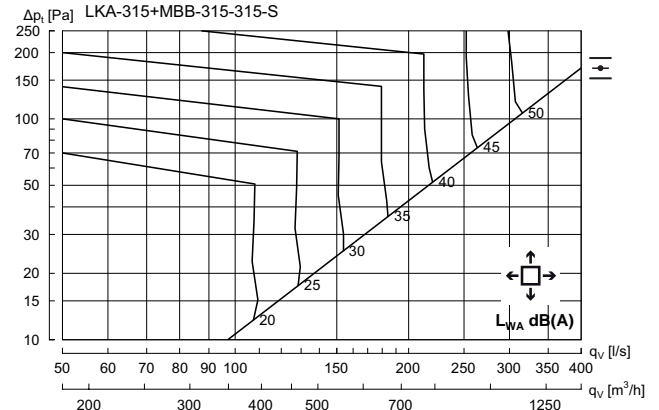

Hz	63	125	250	500	1K	2K	4K	8K
$K_{ok}$	13	5	-2	-1	-4	-17	-25	-36

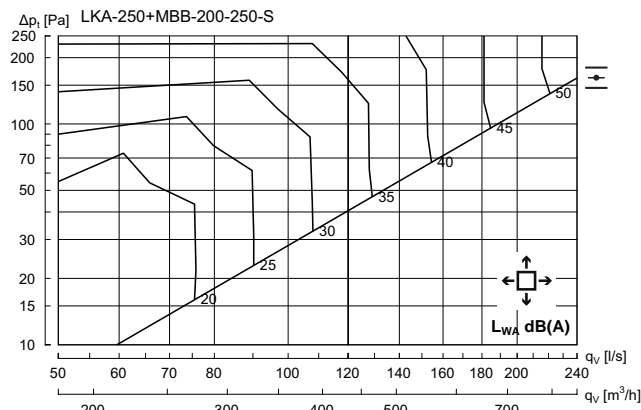

Hz	63	125	250	500	1K	2K	4K	8K
$K_{ok}$	12	6	-2	-1	-5	-14	-19	-23

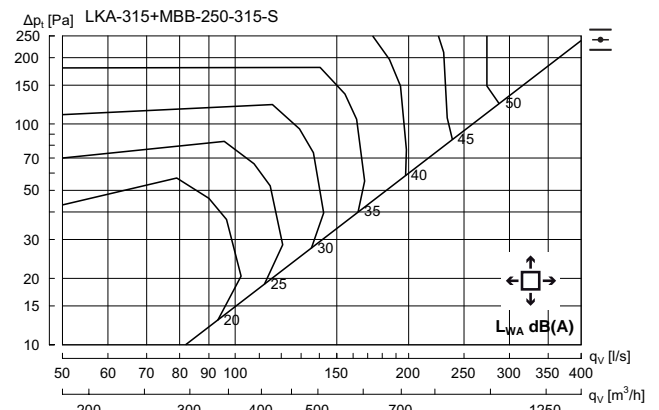

Hz	63	125	250	500	1K	2K	4K	8K
$K_{ok}$	14	5	-2	-2	-4	-13	-19	-26

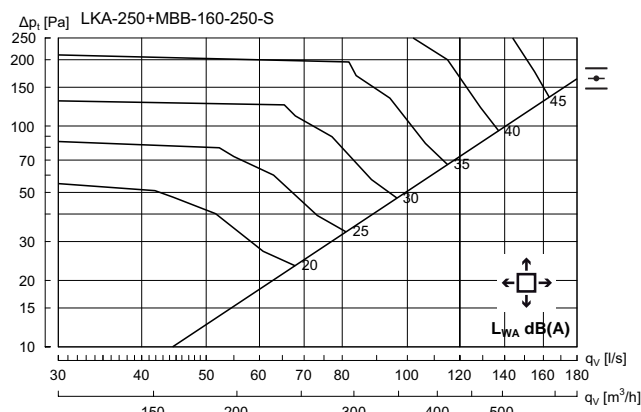

Hz	63	125	250	500	1K	2K	4K	8K
$K_{ok}$	9	7	-2	-3	-5	-10	-15	-21

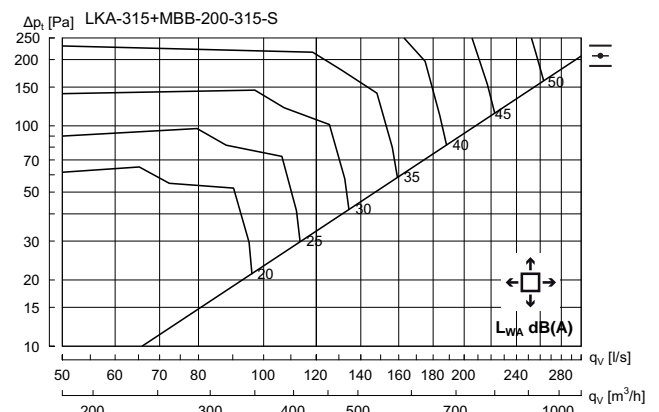

Hz	63	125	250	500	1K	2K	4K	8K
$K_{ok}$	13	6	-2	-3	-4	-11	-17	-22

# Plain diffuser

# LKA

## Technical data

### LKA 400 + MBB - Supply air

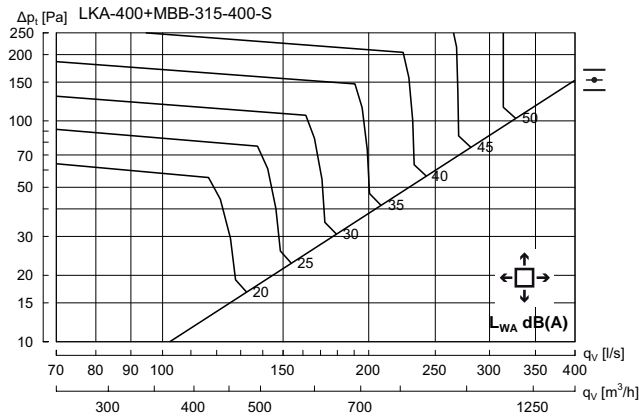

Hz	63	125	250	500	1K	2K	4K	8K
$K_{uk}$	14	6	1	-1	-6	-16	-21	-27

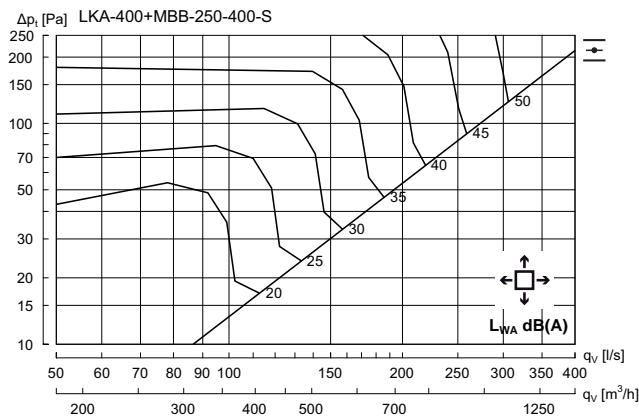

Hz	63	125	250	500	1K	2K	4K	8K
$K_{uk}$	12	7	0	-2	-6	-12	-19	-26

### LKA + MBB - Supply air

### Correction sound power level ( $L_{WA}$ ) and pressure loss ( $\Delta p_t$ )

LKA + MBB		1 - ways		2 - ways		3 - ways	
duct	PKA	$L_{WA}$	$\Delta p_t$	$L_{WA}$	$\Delta p_t$	$L_{WA}$	$\Delta p_t$
$\text{Ø}d_1$	$\text{Ø}d_2$						
100	125	+ 10	x 1,3	+ 4	x 1,1	+ 2	x 1,05
100	160	+ 5	x 1,1	+ 2	x 1,05	+ 1	x 1
125	125	+ 10	x 1,35	+ 6	x 1,1	+ 4	x 1,05
125	160	+ 10	x 1,4	+ 4	x 1,1	+ 1	x 1
125	200	+ 4	x 1,2	+ 2	x 1,05	+ 1	x 1
160	160	+ 16	x 1,8	+ 9	x 1,3	+ 4	x 1,1
160	200	+ 16	x 1,7	+ 10	x 1,2	+ 4	x 1,05
160	250	+ 10	x 1,3	+ 6	x 1,1	+ 3	x 1
200	200	+ 17	x 2,3	+ 11	x 1,4	+ 7	x 1,1
200	250	+ 13	x 1,8	+ 6	x 1,2	+ 4	x 1,1
200	315	+ 9	x 1,5	+ 4	x 1,1	+ 0	x 1,05
250	250	+ 21	x 2,1	+ 11	x 1,4	+ 7	x 1,2
250	315	+ 19	x 1,8	+ 7	x 1,2	+ 3	x 1,1
250	400	+ 10	x 1,5	+ 6	x 1,2	+ 0	x 1
315	315	+ 21	x 2,1	+ 10	x 1,3	+ 4	x 1,1
315	400	+ 21	x 1,8	+ 8	x 1,5	+ 3	x 1,2

# Plain diffuser

LKA

## Technical data

### LKA without box - Exhaust air

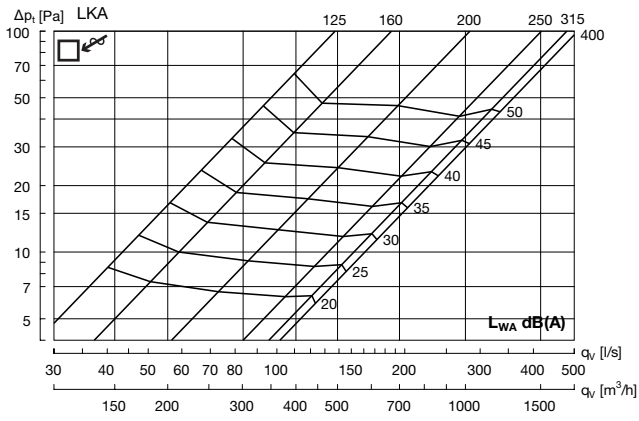

### LKA 125 + MBB - Exhaust air

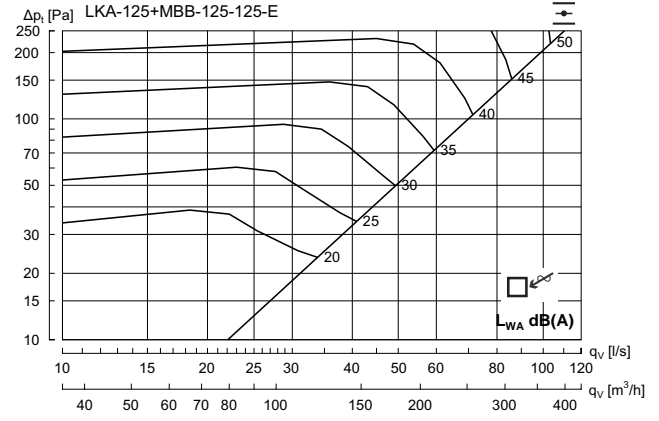

Hz	63	125	250	500	1K	2K	4K	8K
K <sub>uk</sub>	13	4	1	-2	-5	-12	-15	-22

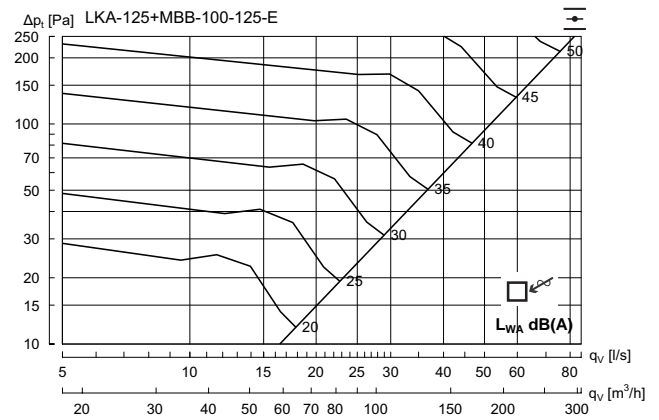

Hz	63	125	250	500	1K	2K	4K	8K
K <sub>uk</sub>	13	0	4	-2	-8	-11	-16	-22

- 1
- 2
- 3
- 4
- 5
- 6
- 7
- 8
- 9
- 10
- 11
- 12
- 13
- 14
- 15
- 16
- 17
- 18



# Plain diffuser

# LKA

## Technical data

### LKA 160 + MBB - Exhaust air

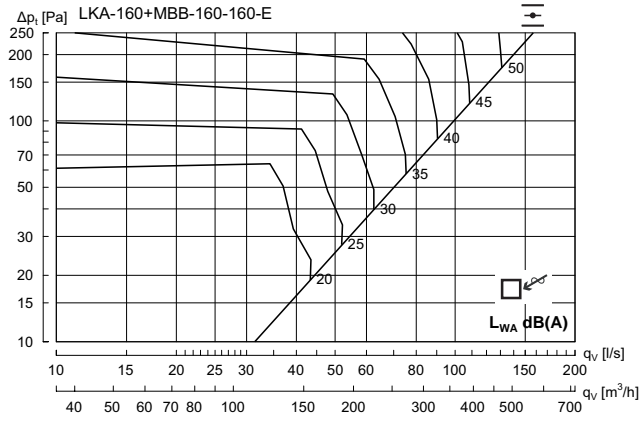

Hz	63	125	250	500	1K	2K	4K	8K
$K_{ok}$	16	6	1	-4	-5	-11	-17	-24

### LKA 200 + MBB - Exhaust air

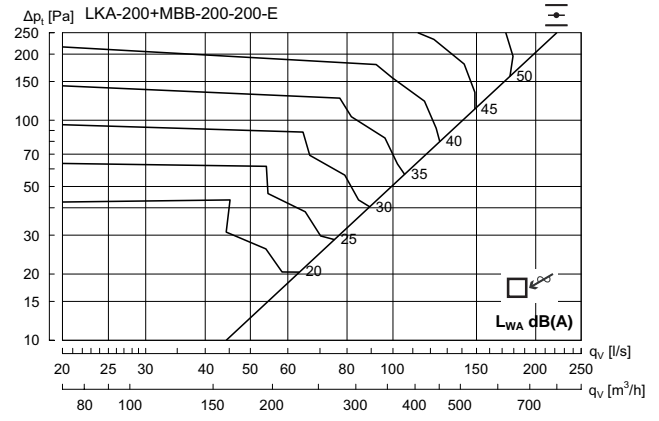

Hz	63	125	250	500	1K	2K	4K	8K
$K_{ok}$	14	6	0	-3	-5	-10	-19	-27

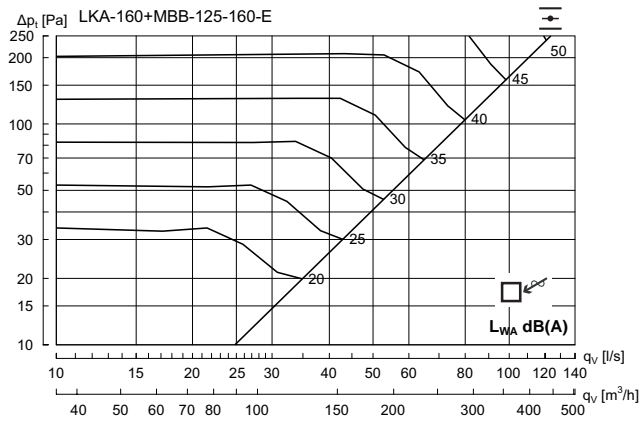

Hz	63	125	250	500	1K	2K	4K	8K
$K_{ok}$	12	6	2	-2	-7	-12	-14	-19

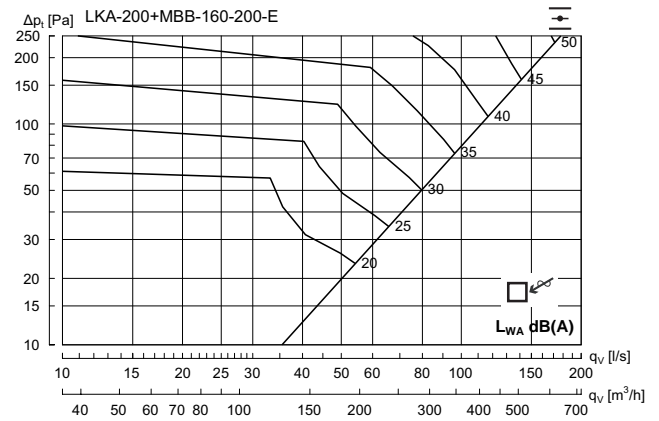

Hz	63	125	250	500	1K	2K	4K	8K
$K_{ok}$	16	7	-1	-4	-6	-10	-14	-20

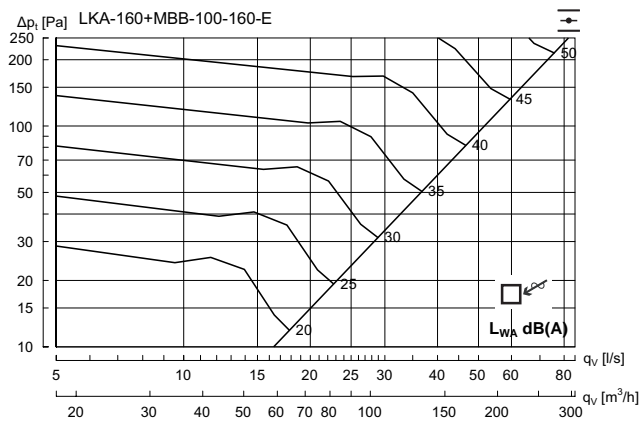

Hz	63	125	250	500	1K	2K	4K	8K
$K_{ok}$	11	-1	5	-2	-9	-13	-18	-24

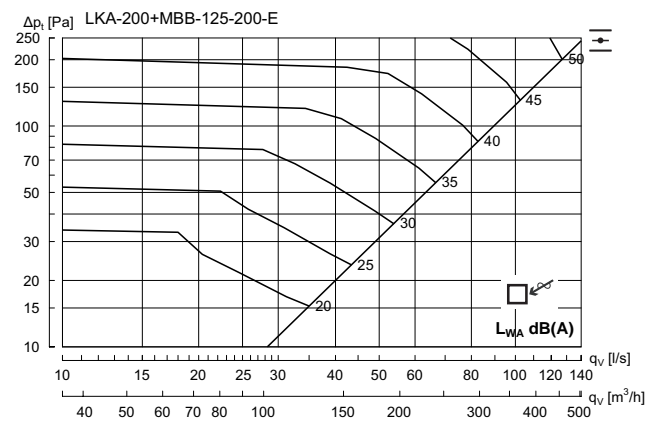

Hz	63	125	250	500	1K	2K	4K	8K
$K_{ok}$	11	3	0	-2	-5	-11	-14	-21

# Plain diffuser

LKA

## Technical data

### LKA 250 + MBB - Exhaust air

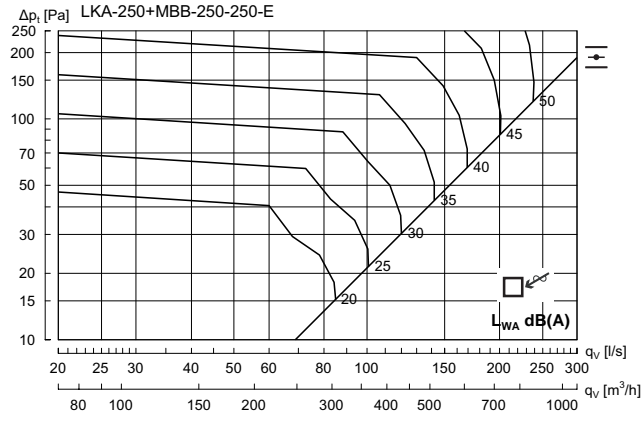

Hz	63	125	250	500	1K	2K	4K	8K
$K_{ok}$	12	4	-1	-3	-3	-12	-19	-30

### LKA 315 + MBB - Exhaust air

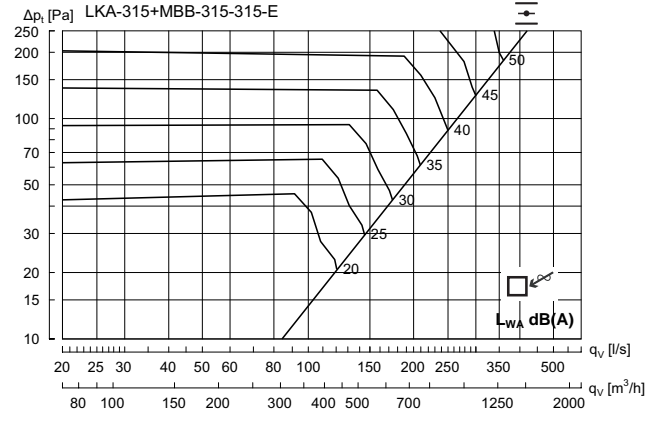

Hz	63	125	250	500	1K	2K	4K	8K
$K_{ok}$	13	5	2	-2	-6	-12	-17	-27

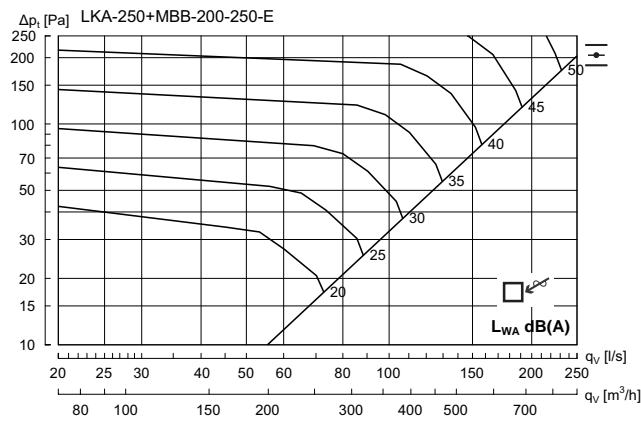

Hz	63	125	250	500	1K	2K	4K	8K
$K_{ok}$	13	3	-1	-3	-4	-11	-15	-24

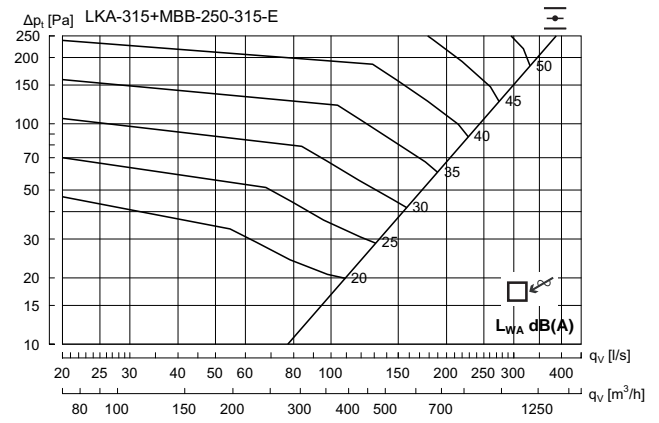

Hz	63	125	250	500	1K	2K	4K	8K
$K_{ok}$	10	5	1	-2	-6	-10	-16	-24

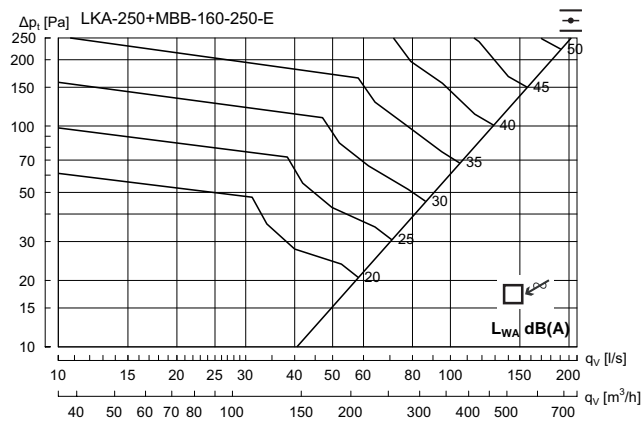

Hz	63	125	250	500	1K	2K	4K	8K
$K_{ok}$	14	6	0	-3	-5	-11	-15	-19

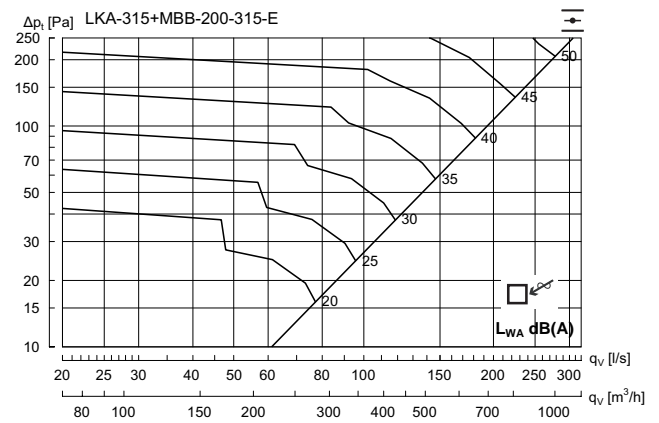

Hz	63	125	250	500	1K	2K	4K	8K
$K_{ok}$	14	5	0	-2	-6	-12	-14	-22

# Plain diffuser

# LKA

## Technical data

### LKA 400 + MBB - Exhaust air

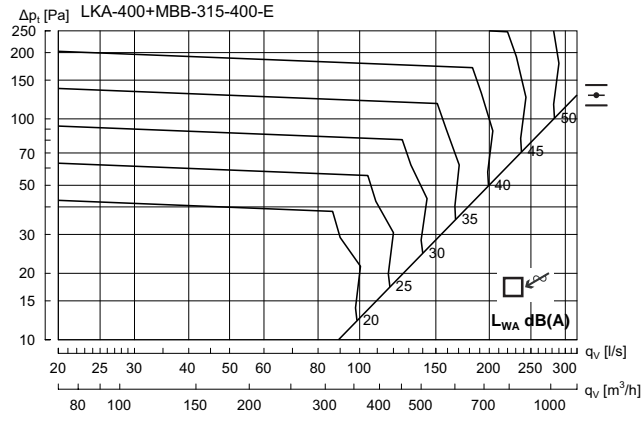

Hz	63	125	250	500	1K	2K	4K	8K
$K_{\alpha}$	10	5	0	0	-6	-15	-20	-27

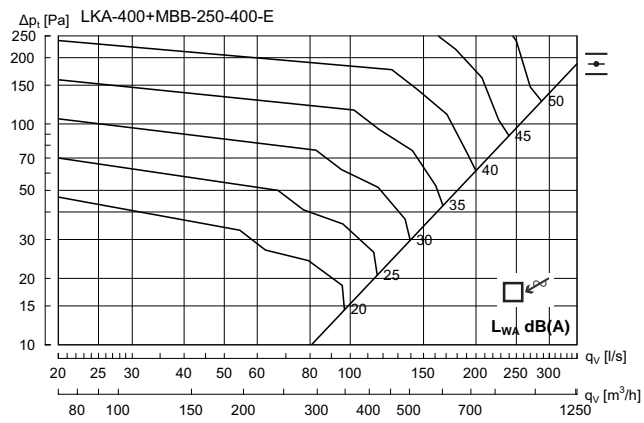

Hz	63	125	250	500	1K	2K	4K	8K
$K_{\alpha}$	12	5	1	-1	-7	-12	-16	-24

- 1
- 2
- 3
- 4
- 5
- 6
- 7
- 8
- 9
- 10
- 11
- 12
- 13
- 14
- 15
- 16
- 17
- 18



# Plain diffuser

# LCA



## Description

LCA is a circular diffuser with an unperforated face plate that can be used for both supply and exhaust air. LCA is suitable for the horizontal supply of cooled air where a high impulse is required. It can be equipped with accessories of various types in order to achieve optimum function. Installing an LCA diffuser in a plenum box type MBB can help to achieve a stable airflow to the diffuser as well as realise the potential for individual adjustment.

- Suitable for both supply and exhaust air
- Suitable for the horizontal supply of cooled air
- High impulse
- Option of 1, 2 and 3-way supply air
- Discrete design

## Maintenance

The face plate can be removed to enable cleaning of internal parts or to gain access to the duct or box. The visible parts of the diffuser can be wiped with a damp cloth.

## Order code

<b>Product</b>	LCA	aaa
<b>Type</b>	LCA	
<b>Connection dim. Ød</b>	Ød 100-400	

Example: LCA-200

## Dimensions

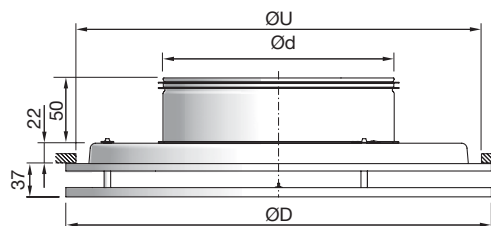

LCA Ød mm	ØD mm	ØU* mm	Free area A m <sup>2</sup>	Weight kg
100	240	200	0,010	1,00
125	240	200	0,011	1,00
160	300	260	0,0165	1,50
200	360	320	0,023	2,30
250	460	420	0,03	3,40
315	540	500	0,037	4,60
400	540	500	0,037	4,60

\* ØU = Ceiling grid opening

## Materials and finish

Material: Galvanised steel  
 Standard finish: Powder-coated  
 Standard colour: White RAL 9010, gloss 30

The diffuser is available in other colours. Please contact Lindab's sales department for further information.

# Plain diffuser

# LCA

## Accessories

### DRZ - Balancing damper

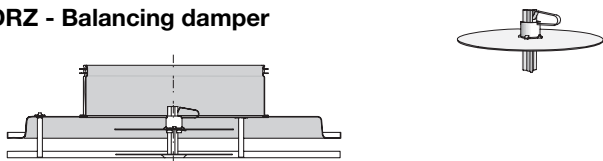

### Blending profiles (set)

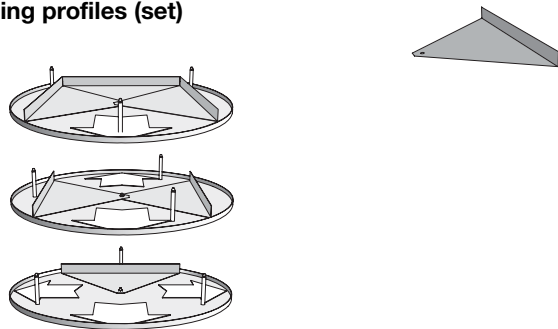

### MBZ - Extension piece



### DDZ - Mounting brackets (set)

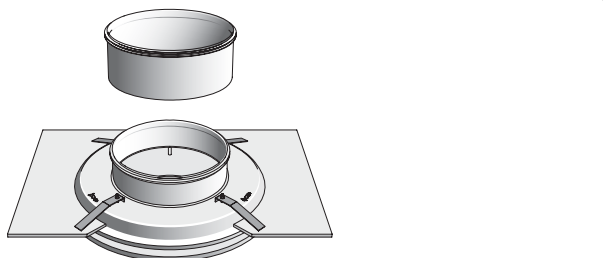

### Order code - accessories

Product	aaa	bbb
Type		
Size		

Example: DRZ-200

### LM - Module plate



### Order code - module plate

Product	LM	a	LCA	ccc
Type				
Ceiling system				
Diffuser				
Size				

Example: LM-1-LCA-200

Ceiling system - see introductory summary

## MBB - Plenum box



### LCA + MBB

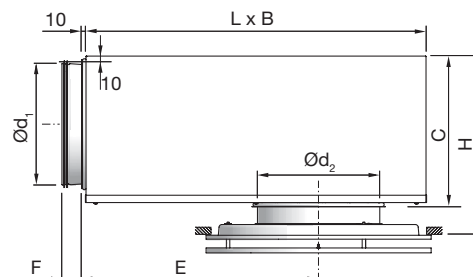

LCA + MBB		B mm	C mm	E mm	F mm	H* mm	L mm
duct Ød <sub>1</sub> mm	LCA Ød <sub>2</sub> mm						
100	100	260	159	216	50	180 - 220	310
100	125	260	159	216	50	180 - 220	310
100	160	260	159	216	50	180 - 220	310
125	125	310	184	262	50	205 - 245	376
125	160	310	184	262	50	205 - 245	376
125	200	310	184	262	50	205 - 245	376
160	160	380	220	323	50	239 - 279	459
160	200	380	220	323	50	239 - 279	459
160	250	380	220	323	50	239 - 279	459
200	200	460	259	396	70	280 - 320	565
200	250	460	259	396	70	280 - 320	565
200	315	460	259	396	70	280 - 320	565
250	250	540	309	486	70	330 - 370	698
250	315	540	309	486	70	330 - 370	698
250	400	540	309	486	70	330 - 370	698
315	315	540	373	646	70	395 - 435	858
315	400	540	373	646	70	395 - 435	858

\* Using accessory MBZ the H dimension will increase:

Ød<sub>2</sub> = 100 - 200 mm => H +40 mm

Ød<sub>2</sub> = 250 - 315 mm => H +60 mm

Ød<sub>2</sub> = 400 mm => H +80 mm

### Order code

Product	MBB	aaa	bbb	c
Type				
MBB				
Duct connection Ød <sub>1</sub>				
Ø100-315				
Diffuser dimension Ød <sub>2</sub>				
Ø100-400				
Function				
S = Supply air				
E = Exhaust				

Example: LCA-200+MBB-200-200-S

# Plain diffuser

# LCA

## Technical data

### Capacity

Air flow  $q_v$  [l/s] and [m<sup>3</sup>/h], total pressure  $\Delta p_t$  [Pa], throw  $l_{0,2}$  [m] and sound power level  $L_{WA}$  [dB(A)] can be seen in the diagrams.

### Frequency-related sound effect level

The sound effect level in the frequency band is defined as  $L_{WA}+K_{ok}$ .  $K_{ok}$  values are specified in charts beneath the diagrams on the following pages.

### Quick selection, supply air

LCA + MBB		$\Delta p_t \geq 50$ Pa 30 dB(A)		$\Delta p_t \geq 50$ Pa 35 dB(A)	
duct $\varnothing d_1$	LCA $\varnothing d_2$	l/s	m <sup>3</sup> /h	l/s	m <sup>3</sup> /h
100	100	27	97	33	119
100	125	31	112	38	137
100	160	40	144	49	176
125	125	42	151	50	180
125	160	53	191	64	230
125	200	59	212	70	252
160	160	60	216	73	263
160	200	70	252	88	317
160	250	94	338	115	414
200	200	98	353	118	425
200	250	106	382	129	464
200	315	133	479	159	572
250	250	116	418	141	508
250	315	136	490	167	601
250	400	139	500	182	655
315	315	153	551	183	659
315	400	169	608	200	720

### Sound attenuation

Sound attenuation of the diffuser  $\Delta L$  from duct to room, including end reflection, see table below.

LCA + MBB		Centre frequency Hz							
duct $\varnothing d_1$	LCA $\varnothing d_2$	63	125	250	500	1K	2K	4K	8K
100	100	18	17	9	19	20	23	22	23
100	125	20	17	6	16	19	20	18	22
100	160	21	17	5	12	19	20	18	21
125	125	17	14	9	19	15	21	18	20
125	160	13	13	9	18	18	18	18	20
125	200	14	12	7	15	16	18	17	19
160	160	18	17	11	16	21	19	20	21
160	200	15	14	9	20	21	20	20	20
160	250	16	16	7	17	13	18	19	20
200	200	14	11	8	15	21	18	20	18
200	250	13	10	8	16	20	17	19	17
200	315	15	9	6	14	17	17	18	17
250	250	16	9	9	17	20	19	19	19
250	315	15	8	9	16	18	16	18	18
250	400	13	6	6	14	16	17	17	17
315	315	8	10	10	16	20	19	18	23
315	400	8	10	10	13	19	19	17	21

### Balancing

Balancing data is contained in a separate brochure.

### Throw $l_{0,2}$

The throw is specified at a terminal velocity of 0.2 m/s .

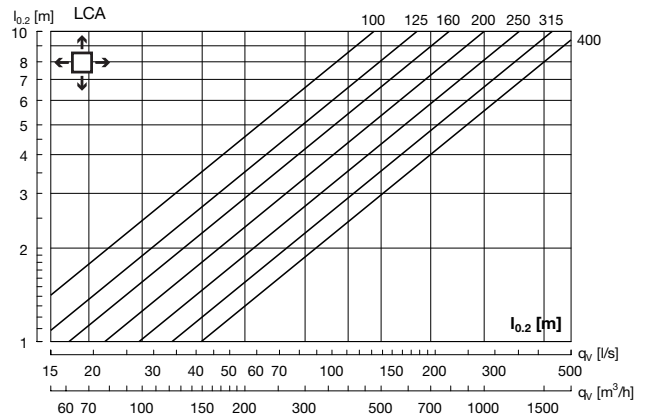

### Correction throw $l_{0,2}$

LCA $\varnothing d$	1 - ways	2 - ways	3 - ways
100	2.4	1.8	1.4
125	2.3	1.8	1.3
160	2.3	1.8	1.3
200	2.3	1.9	1.3
250	2.3	2	1.3
315	2.3	2	1.3
400	2.2	2.1	1.3

### Air jet distribution

$l_b$  = Distance from the diffuser to the point where there is maximum dispersal.

$b_v$  = Depth of the air jet on a vertical plane.

$b_h$  = Width of the air jet on a horizontal plane.

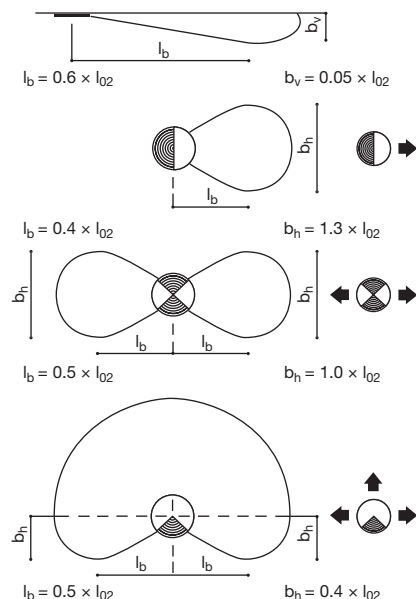

# Plain diffuser

# LCA

## Technical data

### LCA without box - Supply air

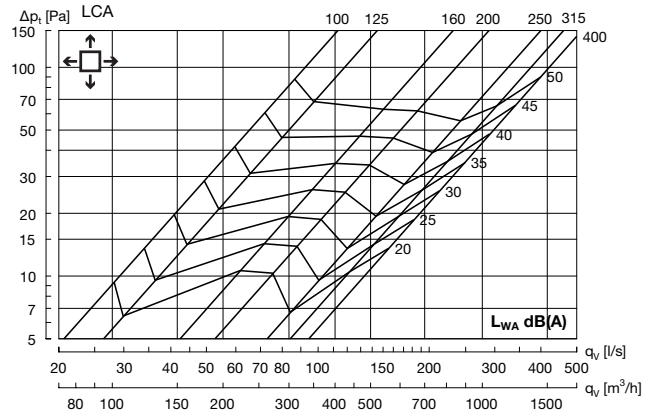

### LCA 100 + MBB - Supply air

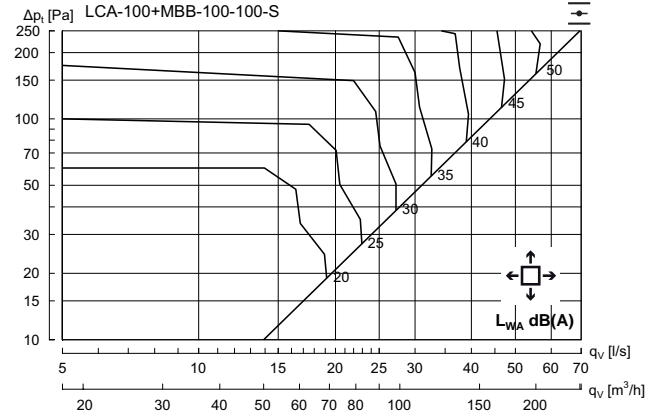

Hz	63	125	250	500	1K	2K	4K	8K
$K_{ok}$	9	7	3	-5	-5	-12	-16	-23



# Plain diffuser

# LCA

## Technical data

### LCA 125 + MBB - Supply air

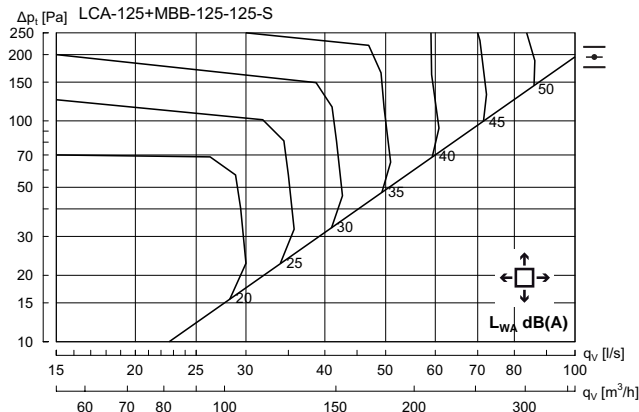

Hz	63	125	250	500	1K	2K	4K	8K
$K_{ok}$	12	6	1	-4	-4	-13	-20	-28

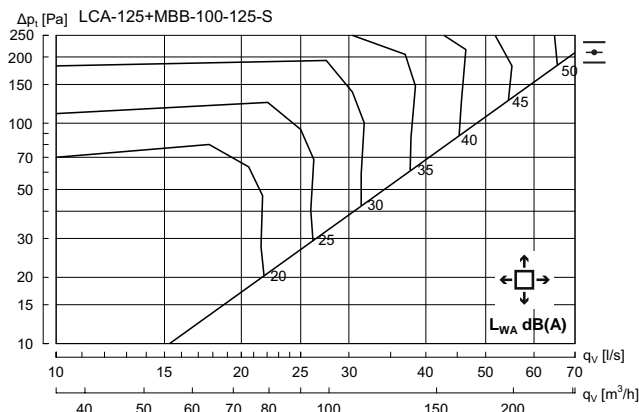

Hz	63	125	250	500	1K	2K	4K	8K
$K_{ok}$	11	7	3	-4	-5	-14	-18	-24

### LCA 160 + MBB - Supply air

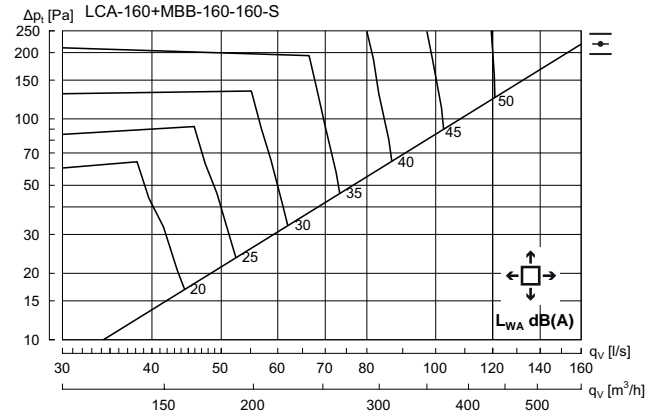

Hz	63	125	250	500	1K	2K	4K	8K
$K_{ok}$	11	11	0	-2	-7	-15	-22	-28

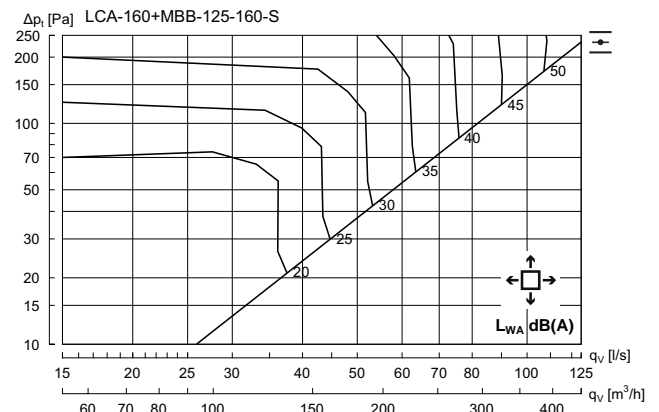

Hz	63	125	250	500	1K	2K	4K	8K
$K_{ok}$	13	8	1	-3	-6	-12	-17	-25

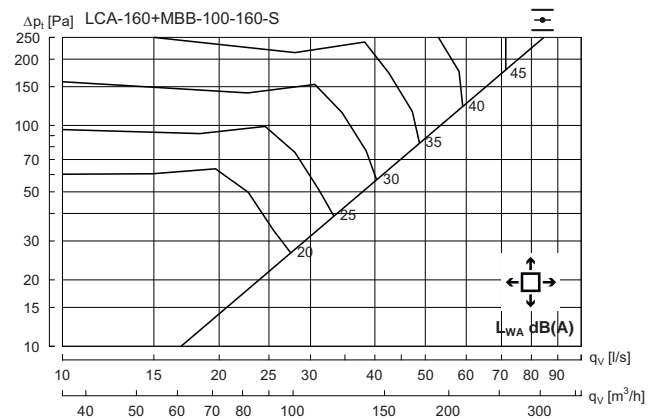

Hz	63	125	250	500	1K	2K	4K	8K
$K_{ok}$	12	5	1	-2	-6	-10	-14	-20

# Plain diffuser

# LCA

## Technical data

### LCA 200 + MBB - Supply air

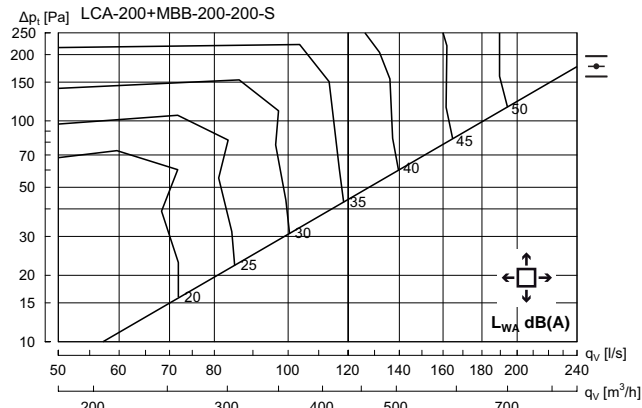

Hz	63	125	250	500	1K	2K	4K	8K
$K_{ok}$	12	6	-1	-1	-5	-15	-21	-26

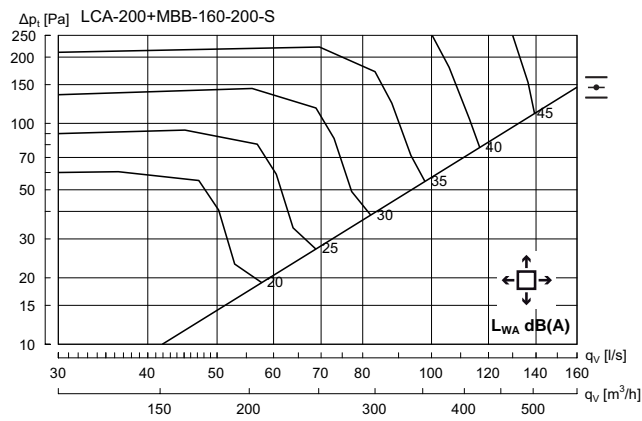

Hz	63	125	250	500	1K	2K	4K	8K
$K_{ok}$	12	9	0	-2	-6	-12	-19	-24

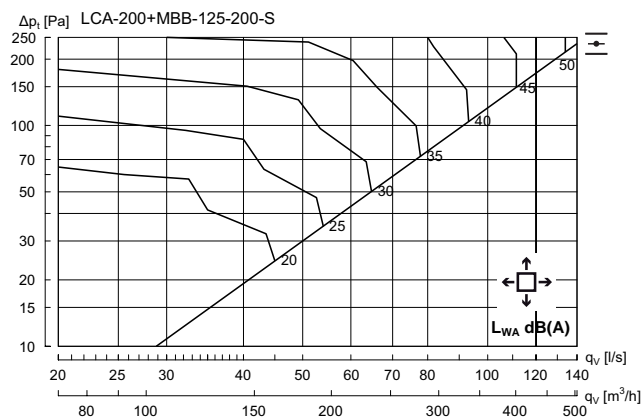

Hz	63	125	250	500	1K	2K	4K	8K
$K_{ok}$	12	7	1	-3	-6	-11	-15	-21

### LCA 250 + MBB - Supply air

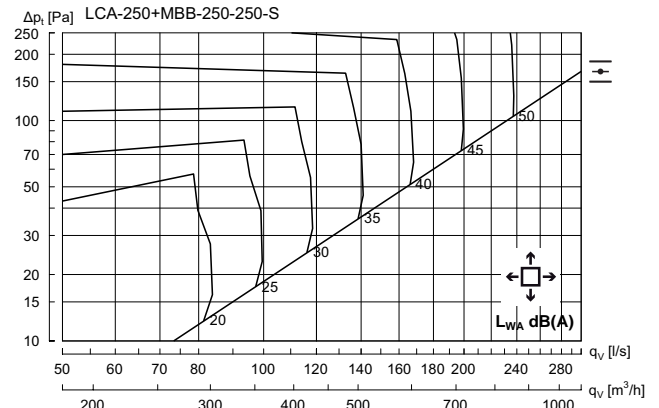

Hz	63	125	250	500	1K	2K	4K	8K
$K_{ok}$	12	3	-4	0	-4	-17	-24	-31

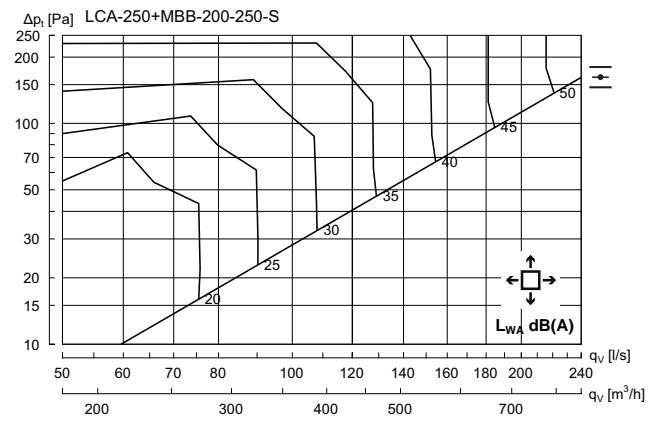

Hz	63	125	250	500	1K	2K	4K	8K
$K_{ok}$	12	6	-2	-1	-5	-14	-19	-23

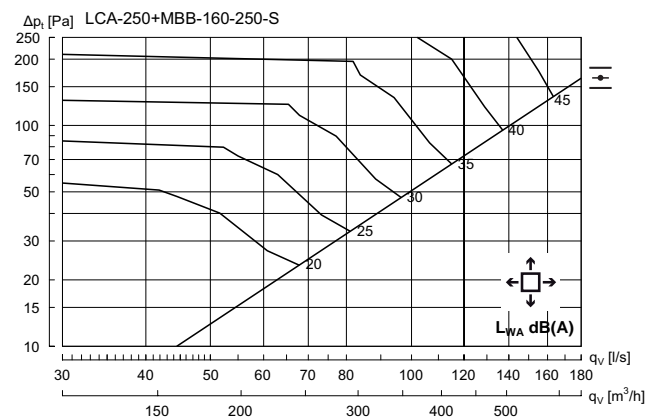

Hz	63	125	250	500	1K	2K	4K	8K
$K_{ok}$	9	7	-2	-3	-5	-10	-15	-21

# Plain diffuser

# LCA

## Technical data

### LCA 315 + MBB - Supply air

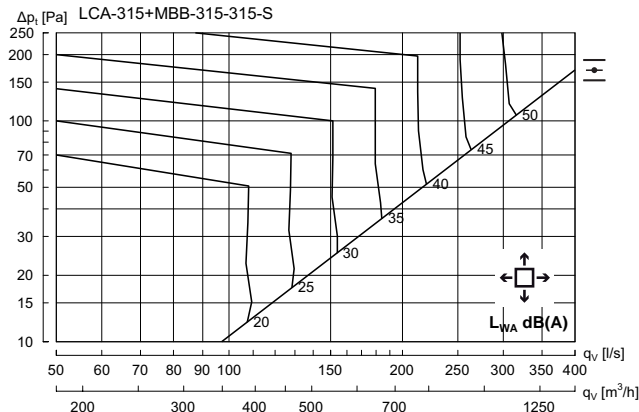

Hz	63	125	250	500	1K	2K	4K	8K
$K_{ok}$	13	5	-2	-1	-4	-17	-25	-36

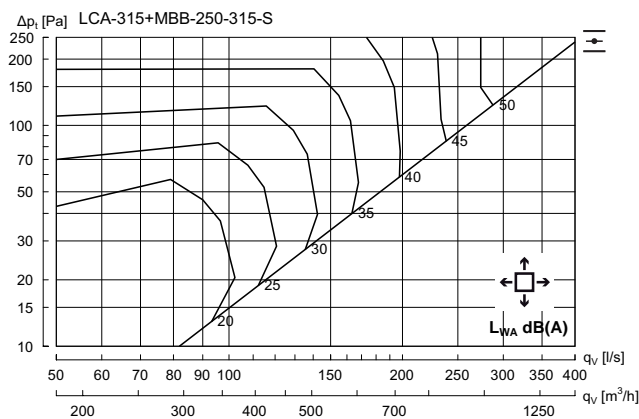

Hz	63	125	250	500	1K	2K	4K	8K
$K_{ok}$	14	5	-2	-2	-4	-13	-19	-26

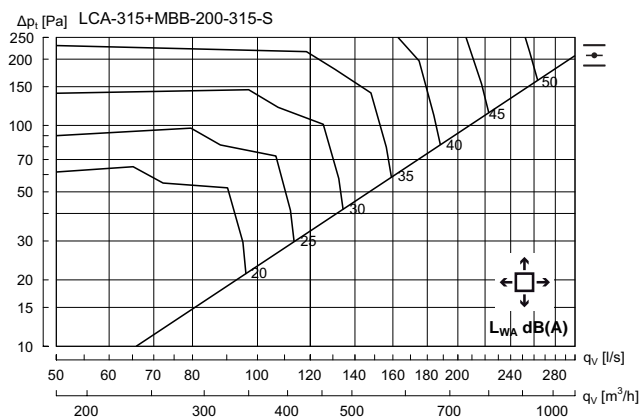

Hz	63	125	250	500	1K	2K	4K	8K
$K_{ok}$	13	6	-2	-3	-4	-11	-17	-22

### LCA 400 + MBB - Supply air

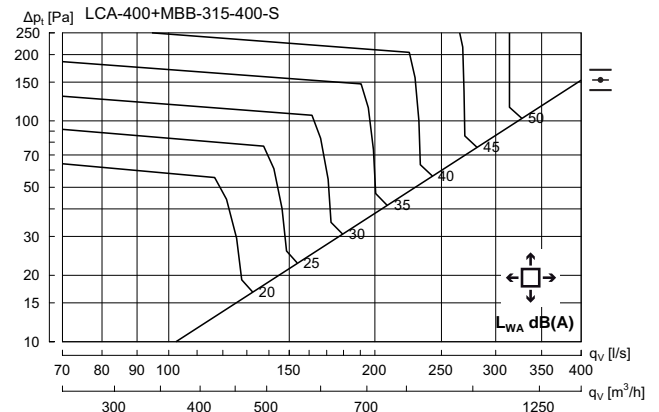

Hz	63	125	250	500	1K	2K	4K	8K
$K_{ok}$	14	6	1	-1	-6	-16	-21	-27

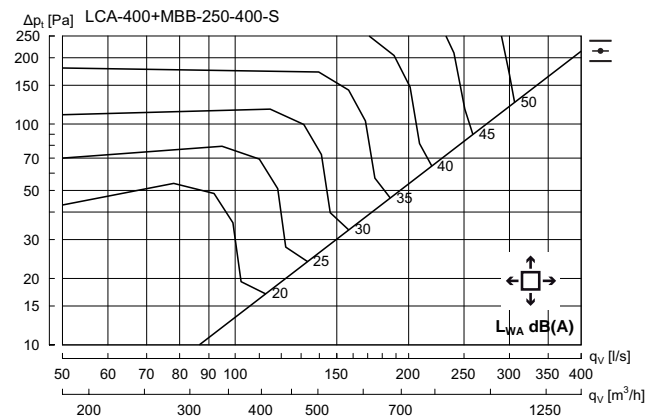

Hz	63	125	250	500	1K	2K	4K	8K
$K_{ok}$	12	7	0	-2	-6	-12	-19	-26

### Correction sound power level ( $L_{WA}$ ) and pressure loss ( $\Delta p_t$ )

LCA + MBB		1 - ways		2 - ways		3 - ways	
duct	LCA	$L_{WA}$	$\Delta p_t$	$L_{WA}$	$\Delta p_t$	$L_{WA}$	$\Delta p_t$
$\varnothing d_1$	$\varnothing d_2$						
100	100	+12	x 1,5	+8	x 1,2	+4	x 1,1
100	125	+10	x 1,3	+4	x 1,1	+2	x 1,05
100	160	+9	x 1,3	+2	x 1,1	+1	x 1
125	125	+12	x 1,5	+8	x 1,2	+4	x 1,1
125	160	+14	x 1,5	+7	x 1,2	+2	x 1,1
125	200	+9	x 1,4	+6	x 1,2	+3	x 1,1
160	160	+16	x 1,8	+9	x 1,3	+4	x 1,1
160	200	+21	x 1,9	+10	x 1,3	+4	x 1,1
160	250	+12	x 1,4	+6	x 1,1	+2	x 1,05
200	200	+24	x 2,5	+10	x 1,5	+5	x 1,2
200	250	+18	x 1,9	+7	x 1,2	+2	x 1,05
200	315	+17	x 1,6	+9	x 1,2	+3	x 1,1
250	250	+21	x 2,3	+10	x 1,4	+5	x 1,1
250	315	+20	x 1,9	+11	x 1,2	+5	x 1,2
250	400	+10	x 1,5	+6	x 1,2	+0	x 1
315	315	+21	x 2,4	+12	x 1,6	+6	x 1,2
315	400	+21	x 1,8	+8	x 1,5	+3	x 1,2

# Plain diffuser

# LCA

## Technical data

### LCA without box - Exhaust air

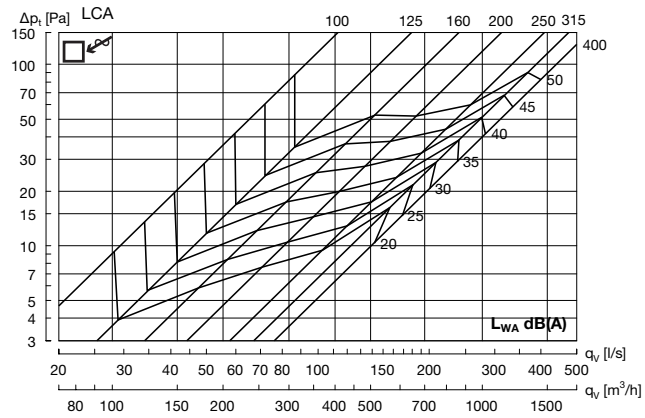

### LCA 100 + MBB - Exhaust air

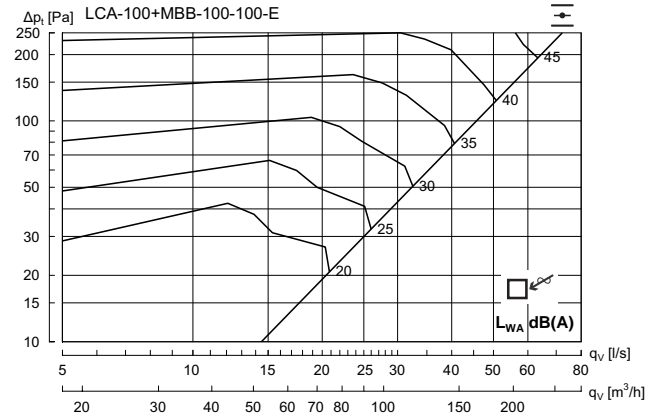

Hz	63	125	250	500	1K	2K	4K	8K
$K_{ok}$	13	1	3	-2	-7	-10	-15	-22

# Plain diffuser

# LCA

## Technical data

### LCA 125 + MBB - Exhaust air

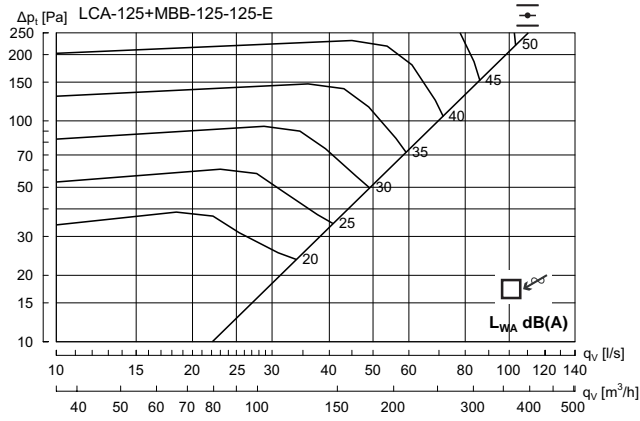

Hz	63	125	250	500	1K	2K	4K	8K
$K_{ok}$	13	4	1	-2	-5	-12	-15	-22

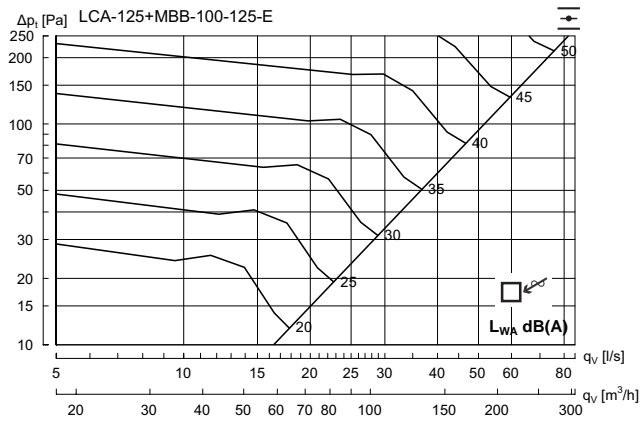

Hz	63	125	250	500	1K	2K	4K	8K
$K_{ok}$	13	0	4	-2	-8	-11	-16	-22

### LCA 160 + MBB - Exhaust air

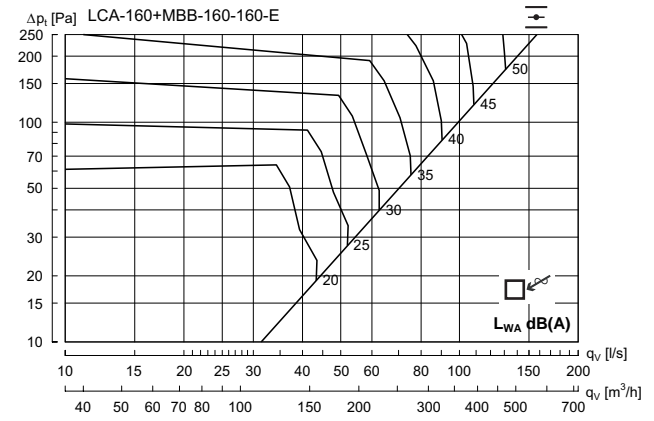

Hz	63	125	250	500	1K	2K	4K	8K
$K_{ok}$	16	6	1	-4	-5	-11	-17	-24

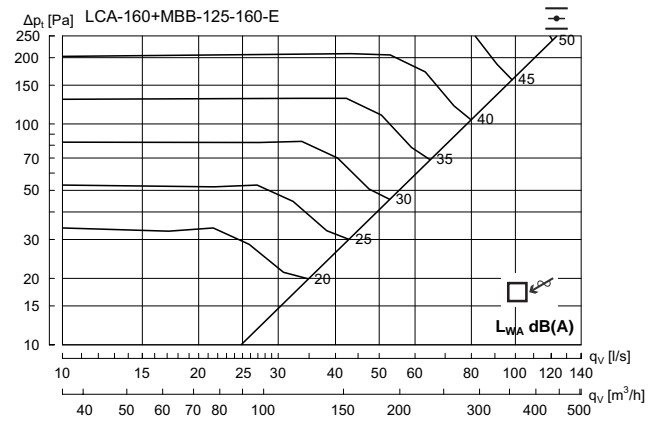

Hz	63	125	250	500	1K	2K	4K	8K
$K_{ok}$	12	6	2	-2	-7	-12	-14	-19

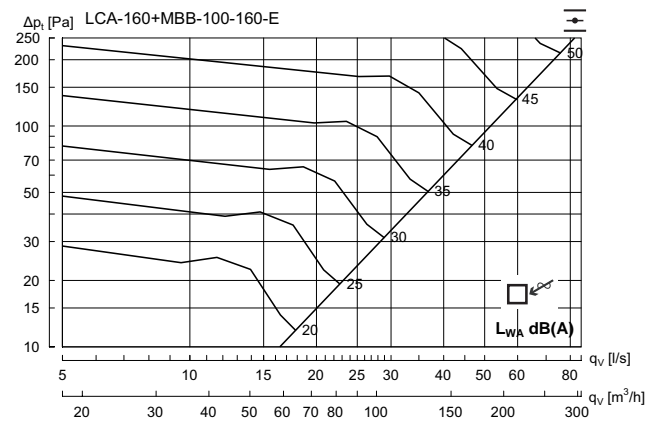

Hz	63	125	250	500	1K	2K	4K	8K
$K_{ok}$	11	-1	5	-2	-9	-13	-18	-24



# Plain diffuser

# LCA

## Technical data

### LCA 200 + MBB - Exhaust air

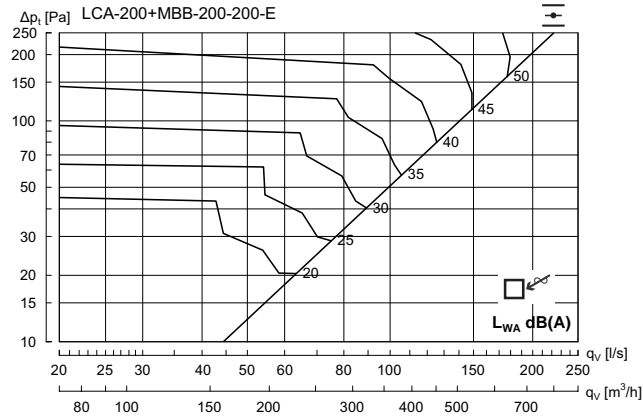

Hz	63	125	250	500	1K	2K	4K	8K
$K_{ok}$	14	6	0	-3	-5	-10	-19	-27

### LCA 250 + MBB - Exhaust air

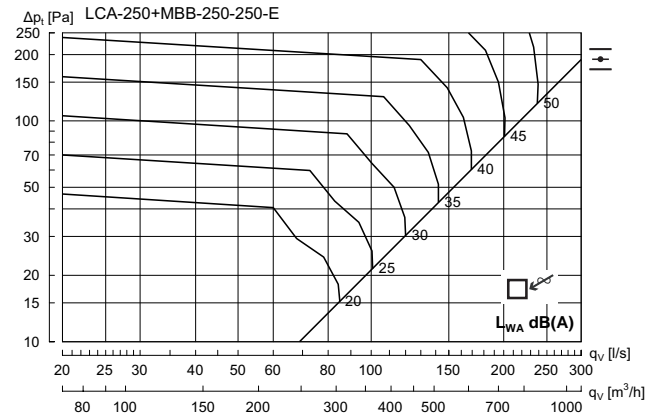

Hz	63	125	250	500	1K	2K	4K	8K
$K_{ok}$	12	4	-1	-3	-3	-12	-19	-30

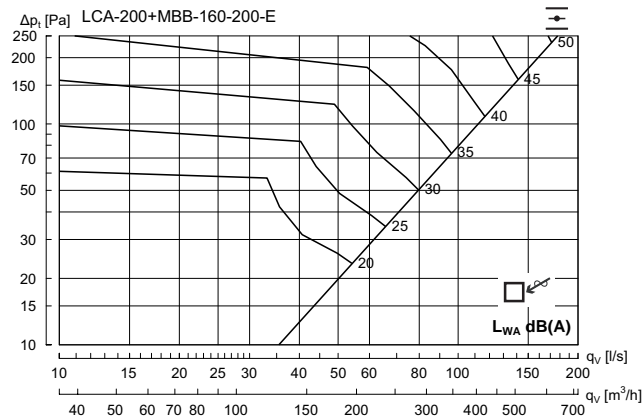

Hz	63	125	250	500	1K	2K	4K	8K
$K_{ok}$	16	7	-1	-4	-6	-10	-14	-20

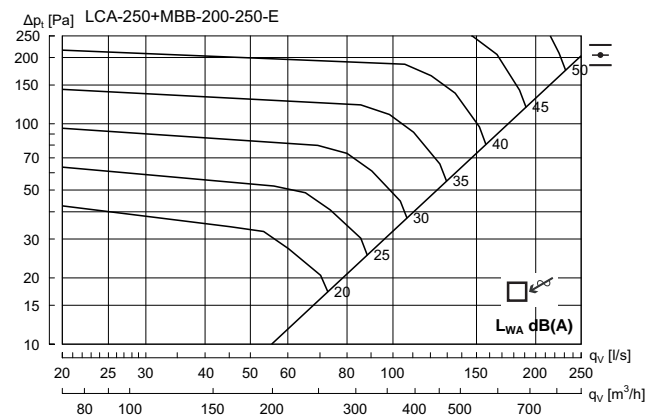

Hz	63	125	250	500	1K	2K	4K	8K
$K_{ok}$	13	3	-1	-3	-4	-11	-15	-24

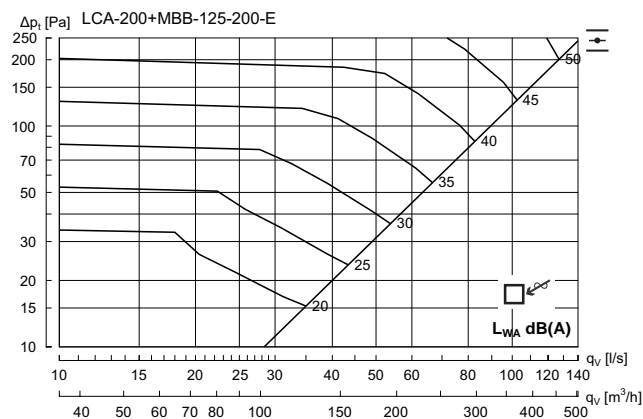

Hz	63	125	250	500	1K	2K	4K	8K
$K_{ok}$	11	3	0	-2	-5	-11	-14	-21

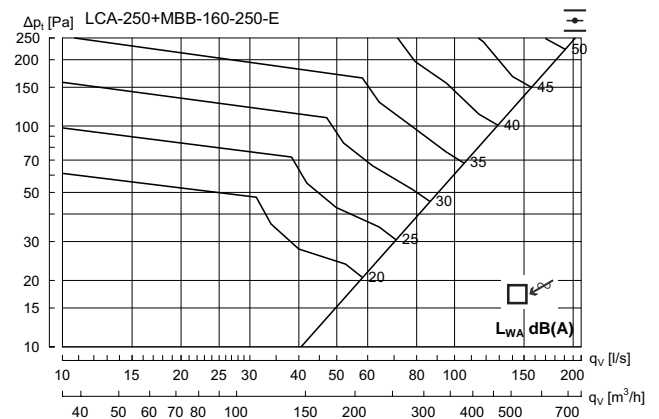

Hz	63	125	250	500	1K	2K	4K	8K
$K_{ok}$	14	6	0	-3	-5	-11	-15	-19

# Plain diffuser

# LCA

## Technical data

### LCA 315 + MBB - Exhaust air

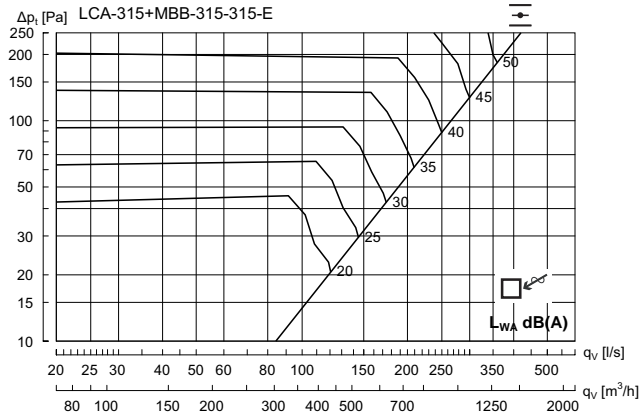

Hz	63	125	250	500	1K	2K	4K	8K
$K_{sk}$	13	5	2	-2	-6	-12	-17	-27

### LCA 400 + MBB - Exhaust air

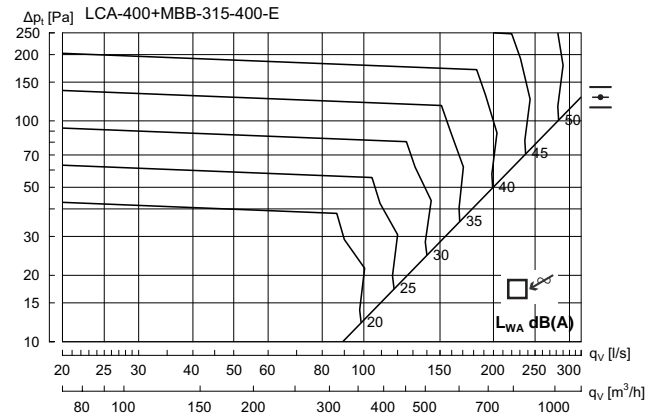

Hz	63	125	250	500	1K	2K	4K	8K
$K_{sk}$	10	5	0	0	-6	-15	-20	-27

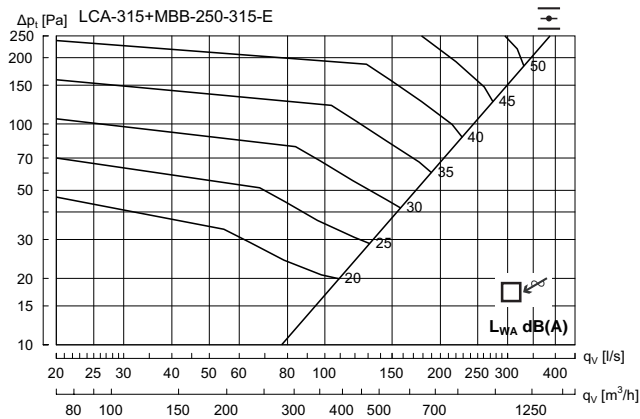

Hz	63	125	250	500	1K	2K	4K	8K
$K_{sk}$	10	5	1	-2	-6	-10	-16	-24

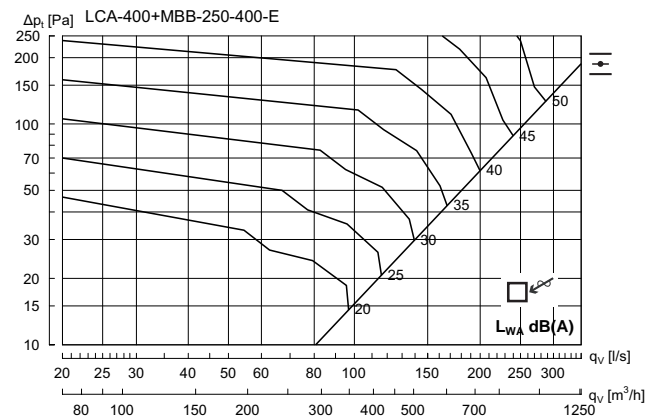

Hz	63	125	250	500	1K	2K	4K	8K
$K_{sk}$	12	5	1	-1	-7	-12	-16	-24

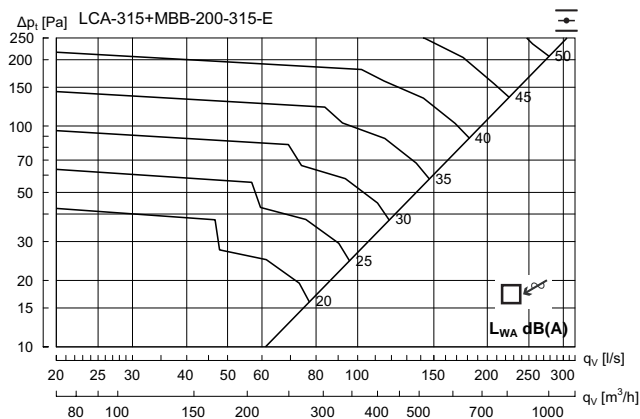

Hz	63	125	250	500	1K	2K	4K	8K
$K_{sk}$	14	5	0	-2	-6	-12	-14	-22







# Plain diffuser

# CRL



## Description

CRL is a circular diffuser with an unperforated adjustable face plate. CRL can be used both for supply and exhaust air. The diffuser can be switched between horizontal and vertical supply air, and is therefore suitable for the horizontal supply of cooled air or vertical supply of heated air. Installing a CRL diffuser in a plenum box type MBB can help to achieve a stable airflow to the diffuser as well as realise the potential for individual adjustment. It is also possible to install a damper directly in the diffuser to enable adjustment without a box.

- Suitable for both supply and exhaust air
- Suitable for horizontal or vertical supply air patterns
- A damper can be installed on the diffuser to achieve adjustment

## Maintenance

The face plate can be removed to enable cleaning of internal parts or to gain access to the duct or plenum box. The visible parts of the diffuser can be wiped with a damp cloth.

## Order code

<b>Product Type</b> CRL	<b>CRL</b>	<b>aaa</b>
<b>Connection dim. Ød</b> Ød 100-400		

Example: CRL-200

## Dimensions

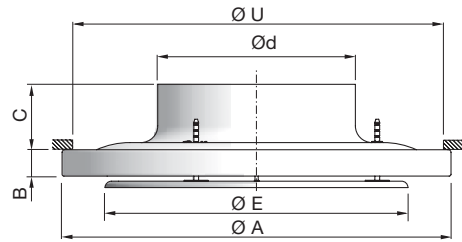

CRL Ød	ØA	B	C	ØE	ØU*	Weight
mm	mm	mm	mm	mm	mm	kg
100	188	15	60	146	170	0.30
125	238	20	65	180	210	0.50
160	288	25	65	220	255	0.60
200	388	28	72	300	355	1.10
250	488	33	82	380	390	1.60
315	588	33	97	490	465	2.50
400	720	40	100	590	670	3.80

\* ØU = Ceiling grid opening

## Dispersal patterns

CRL is supplied with vertical supply air as standard. The dispersal pattern can be changed to horizontal supply air by moving the face plate.

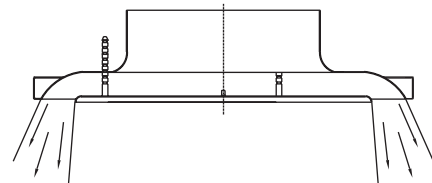

Vertical supply air.

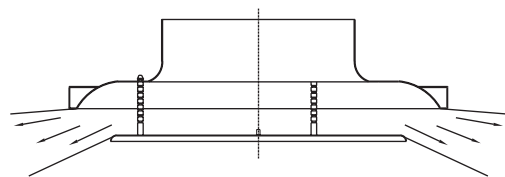

Horizontal supply air.

## Materials and finish:

Grille box: Aluminium  
 Face plate: Galvanised steel  
 Standard finish: Powder-coated  
 Standard colour: White RAL 9010, gloss 30

The diffuser is available in other colours. Please contact Lindab's sales department for further information.

# Plain diffuser

# CRL

## Accessories

### CAZ - Balancing damper

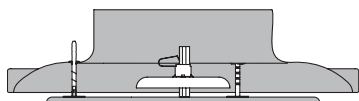

### MBZ - Extension piece



### DCZ - Mounting brackets (set)

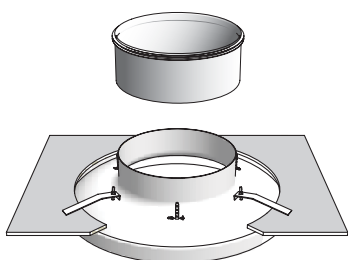

## Order code - accessoires

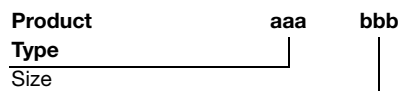

Example: CAZ-125

## MBB - Plenum box



### CRL + MBB

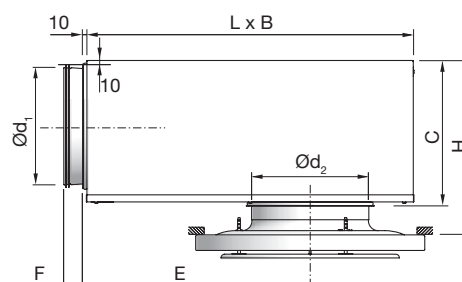

CRL + MBB		B mm	C mm	E mm	F mm	H* mm	L mm
duct Ød <sub>1</sub> mm	CRL Ød <sub>2</sub> mm						
100	100	260	159	216	50	175 - 210	310
100	125	260	159	216	50	175 - 205	310
100	160	260	159	216	50	175 - 205	310
125	125	310	184	262	50	200 - 230	376
125	160	310	184	262	50	200 - 230	376
125	200	310	184	262	50	210 - 245	376
160	160	380	220	323	50	235 - 265	459
160	200	380	220	323	50	245 - 280	459
160	250	380	220	323	50	250 - 290	459
200	200	460	259	396	70	285 - 320	565
200	250	460	259	396	70	290 - 332	565
200	315	460	259	396	70	290 - 345	565
250	250	540	309	486	70	340 - 380	698
250	315	540	309	486	70	340 - 395	698
250	400	540	309	486	70	370 - 400	698
315	315	540	373	646	70	405 - 460	858
315	400	540	373	646	70	435 - 465	858

### USING CRL + MBB => ALWAYS USE MBZ

\* Using accessory MBZ the H dimension will increase:

- Ød<sub>2</sub> = 100 - 200 mm => H +40 mm
- Ød<sub>2</sub> = 250 - 315 mm => H +60 mm
- Ød<sub>2</sub> = 400 mm => H +80 mm

## Order code

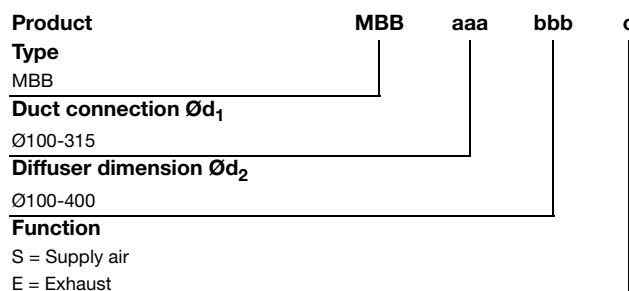

Example: CRL-200+MBB-160-200-S

# Plain diffuser

# CRL

## Technical data

### Capacity

Air flow  $q_v$  [l/s] and [m<sup>3</sup>/h], total pressure  $\Delta p_t$  [Pa], throw  $l_{0,2}$  [m] and sound power level  $L_{WA}$  [dB(A)] can be seen in the diagrams.

### Frequency-related sound effect level

The sound effect level in the frequency band is defined as  $L_{WA} + K_{ok}$ .  $K_{ok}$  values are specified in charts beneath the diagrams and on the following pages.  $K_{ok}$  values for CRL without a box are available on request.

### Quick selection, supply air

CRL + MBB		$\Delta p_t \geq 50$ Pa 30 dB(A)		$\Delta p_t \geq 50$ Pa 35 dB(A)	
duct	CRL	l/s	m <sup>3</sup> /h	l/s	m <sup>3</sup> /h
$\varnothing d_1$	$\varnothing d_2$				
100	100	26	94	31	112
100	125	35	126	42	151
100	160	42	151	50	180
125	125	46	166	54	194
125	160	58	209	68	245
125	200	62	223	75	270
160	160	67	241	81	292
160	200	86	310	105	378
160	250	96	346	121	436
200	200	107	385	127	457
200	250	135	486	160	576
200	315	146	526	177	637
250	250	151	544	183	659
250	315	161	580	215	774
250	400	185	666	252	907
315	315	206	742	263	947
315	400	227	817	309	1112

### Sound attenuation

Sound attenuation of the diffuser  $\Delta L$  from duct to room, including end reflection, see table below.

CRL + MBB		Centre frequency Hz							
duct	CRL	63	125	250	500	1K	2K	4K	8K
$\varnothing d_1$	$\varnothing d_2$								
100	100	20	17	7	20	19	20	20	22
100	125	21	16	6	18	19	18	19	21
100	160	21	16	5	15	17	18	18	18
125	125	18	13	7	20	12	19	19	20
125	160	15	14	8	19	12	17	17	19
125	200	14	12	6	16	14	16	17	16
160	160	18	17	10	18	16	18	21	20
160	200	15	14	7	19	17	18	19	19
160	250	15	15	4	15	13	14	16	18
200	200	14	10	7	14	19	16	20	17
200	250	15	9	5	14	19	16	17	16
200	315	13	8	4	11	16	15	16	15
250	250	16	8	7	16	18	18	18	17
250	315	11	7	6	16	17	17	16	16
250	400	15	6	5	10	14	16	15	15
315	315	8	10	9	14	18	18	17	21
315	400	8	8	8	11	16	17	16	19

### Throw $l_{0,2}$

The throw is specified at a terminal velocity of 0.2 m/s. Diagram below shows throw  $l_{0,2}$  for horizontal supply air.

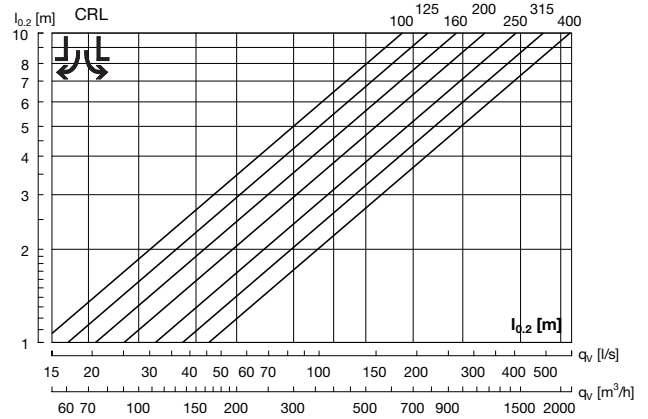

### Correction throw $l_{0,2}$ for vertical supply air

CRL $\varnothing d$	Correction factor
100	3,1
125	2,7
160	2,7
200	2,7
250	2,6
315	2,4
400	2,3

### Air jet distribution

$l_b$  = Distance from the diffuser to the point where there is maximum dispersal.

$b_v$  = Depth of the air jet on a vertical plane.

$b_h$  = Width of the air jet on a horizontal plane

#### Horizontal supply air pattern

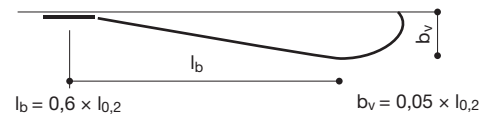

#### Vertical supply air pattern

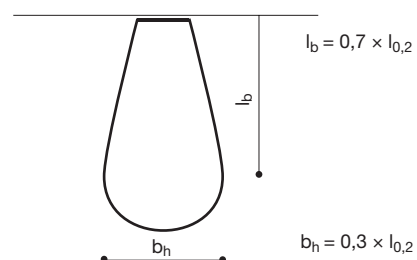

# Plain diffuser

# CRL

## Technical data

### Throw $l_{0,2}$ / turning point $l_{0,0}$

Throw  $l_{0,2}$  [m] is specified at a speed of 0.2 m/s. Turning point  $l_{0,0}$  [m] is specified for +5 K, +10 K respectively.

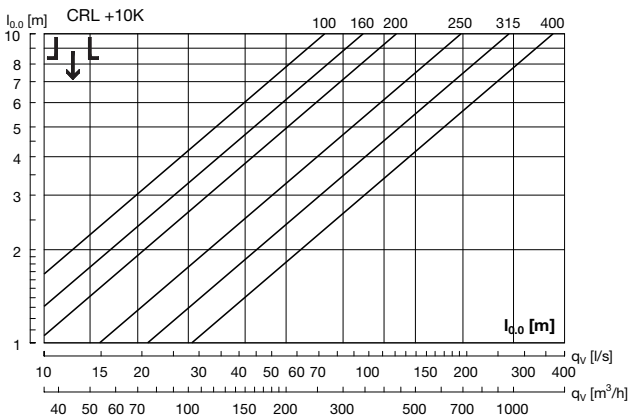
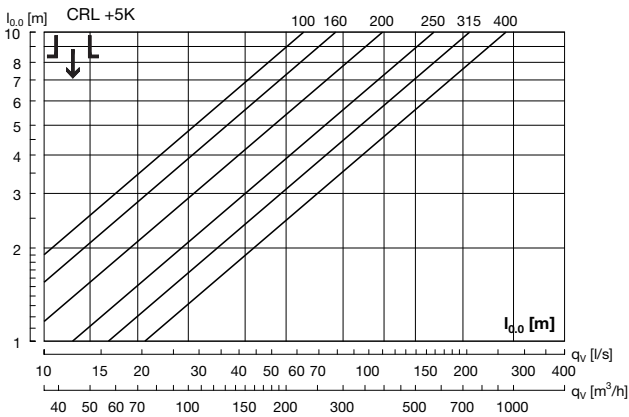
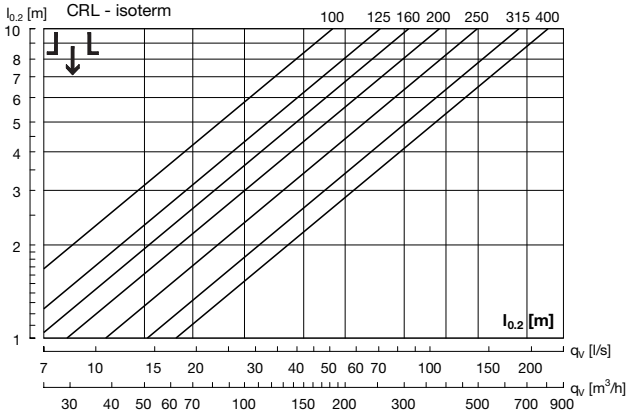

### CRL without box - Supply air

#### Supply air - horizontal

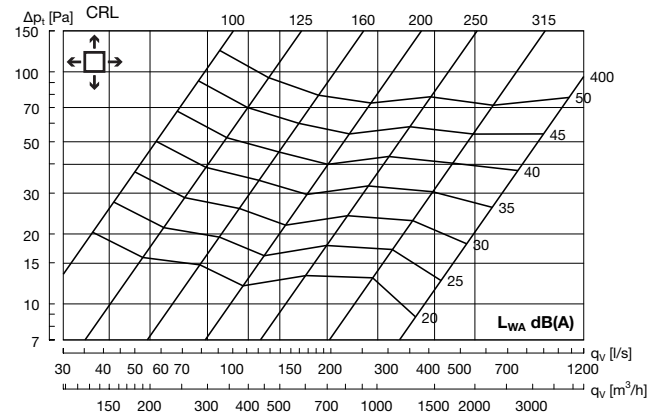

#### Supply air - vertical

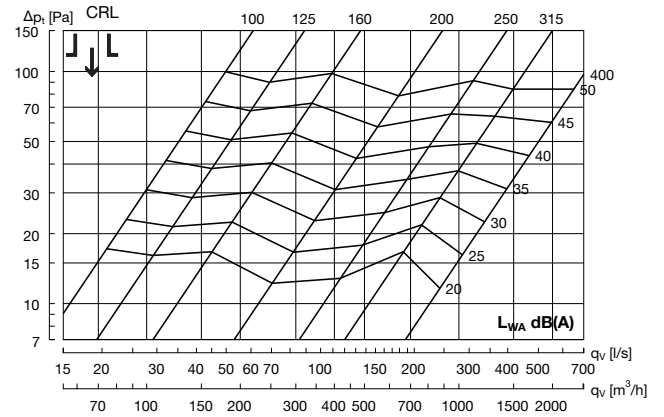

# Plain diffuser

# CRL

## Technical data

### CRL 100 + MBB - Supply air

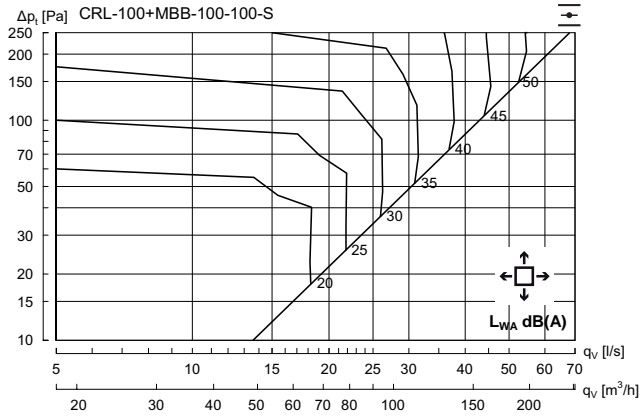

Hz	63	125	250	500	1K	2K	4K	8K
$K_{ok}$	12	8	5	-7	-8	-14	-17	-22

### CRL 125 + MBB - Supply air

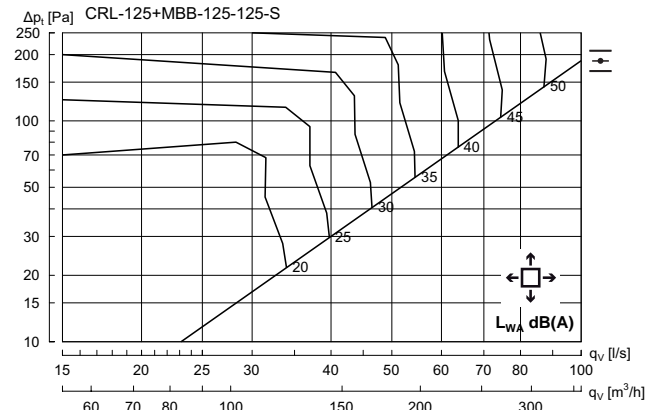

Hz	63	125	250	500	1K	2K	4K	8K
$K_{ok}$	11	9	3	-5	-6	-14	-20	-24

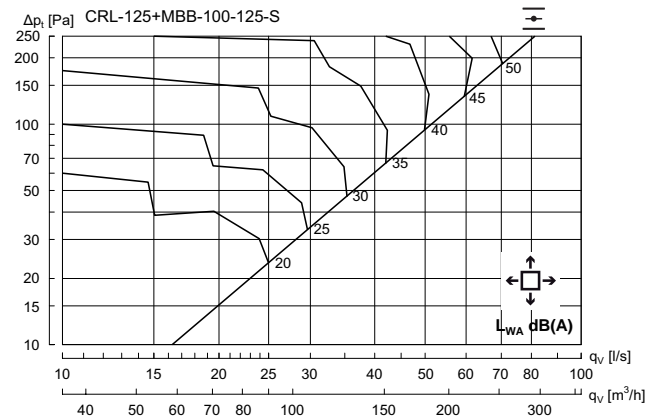

Hz	63	125	250	500	1K	2K	4K	8K
$K_{ok}$	13	8	3	-5	-7	-11	-15	-19



# Plain diffuser

# CRL

## Technical data

### CRL 160 + MBB - Supply air

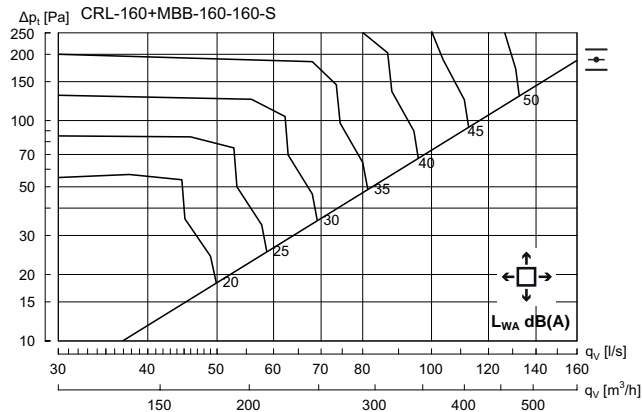

Hz	63	125	250	500	1K	2K	4K	8K
$K_{ok}$	11	12	3	-7	-7	-15	-20	-23

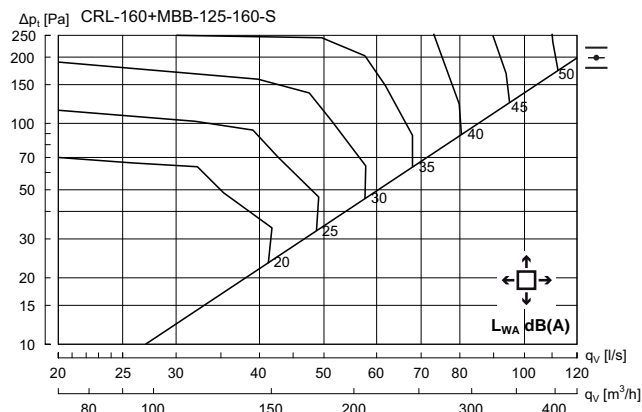

Hz	63	125	250	500	1K	2K	4K	8K
$K_{ok}$	12	8	3	-5	-6	-11	-17	-22

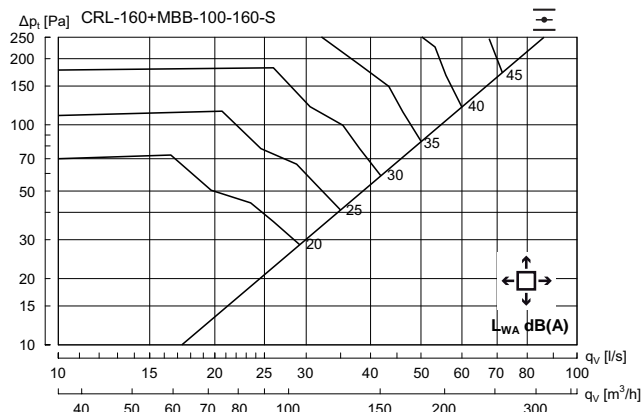

Hz	63	125	250	500	1K	2K	4K	8K
$K_{ok}$	9	3	1	-3	-5	-9	-15	-19

### CRL 200 + MBB - Supply air

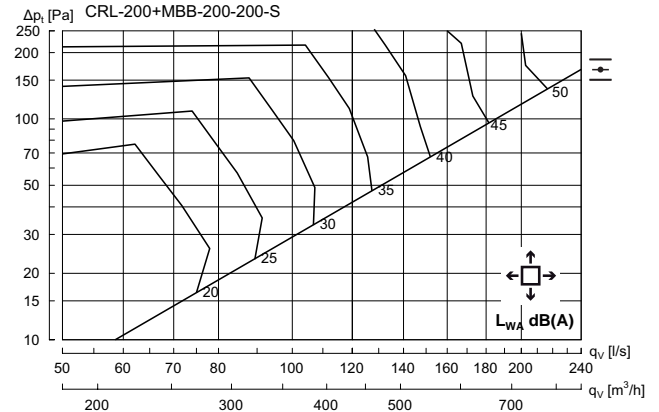

Hz	63	125	250	500	1K	2K	4K	8K
$K_{ok}$	12	11	1	-3	-7	-15	-20	-24

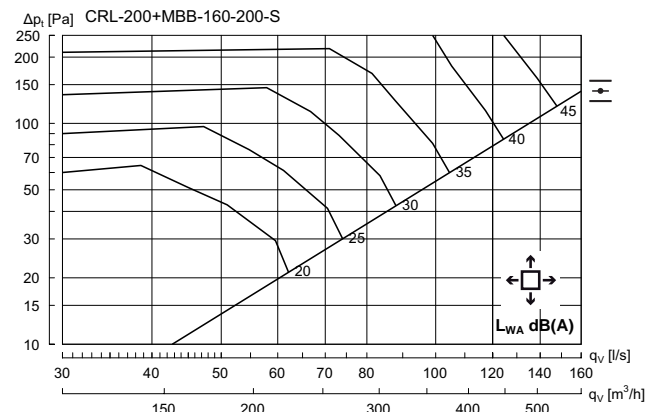

Hz	63	125	250	500	1K	2K	4K	8K
$K_{ok}$	12	8	1	-4	-5	-10	-18	-22

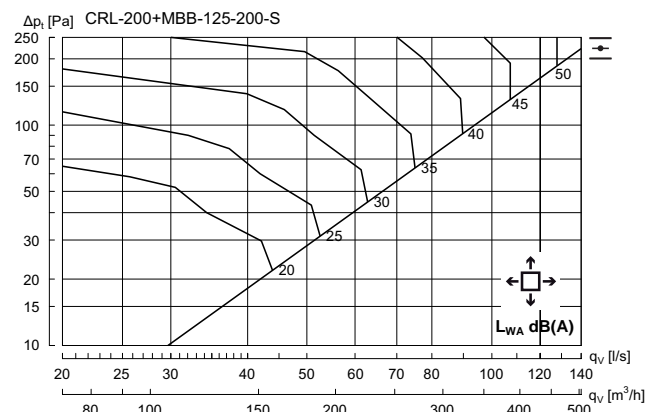

Hz	63	125	250	500	1K	2K	4K	8K
$K_{ok}$	10	5	1	-4	-5	-10	-16	-20

# Plain diffuser

# CRL

## Technical data

### CRL 250+ MBB - Supply air

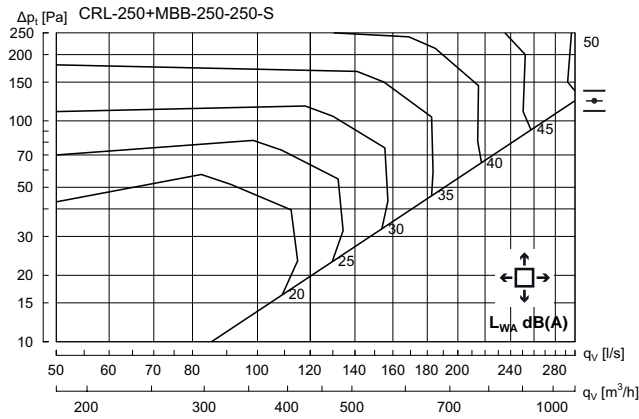

Hz	63	125	250	500	1K	2K	4K	8K
$K_{ok}$	15	7	0	-2	-6	-12	-16	-21

### CRL 315 + MBB - Supply air

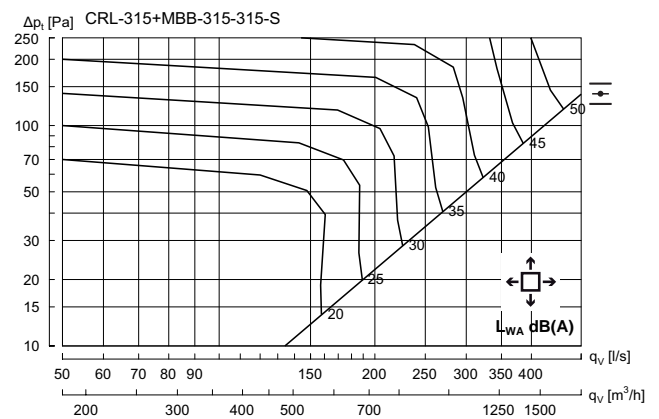

Hz	63	125	250	500	1K	2K	4K	8K
$K_{ok}$	15	4	1	-2	-6	-13	-17	-16

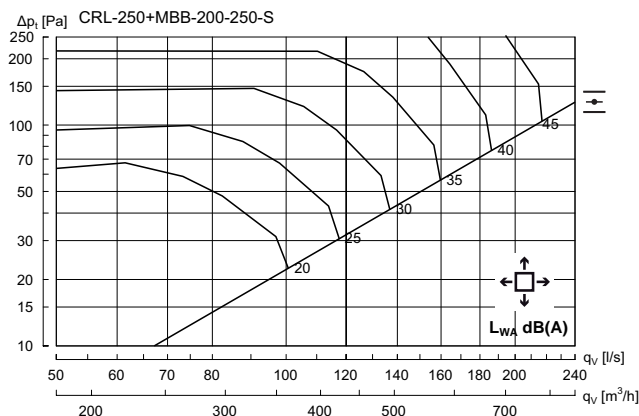

Hz	63	125	250	500	1K	2K	4K	8K
$K_{ok}$	11	7	-1	-2	-5	-12	-17	-22

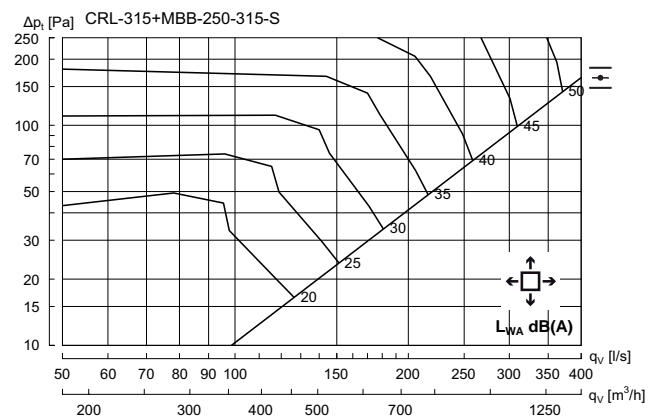

Hz	63	125	250	500	1K	2K	4K	8K
$K_{ok}$	13	6	-1	-2	-5	-12	-17	-23

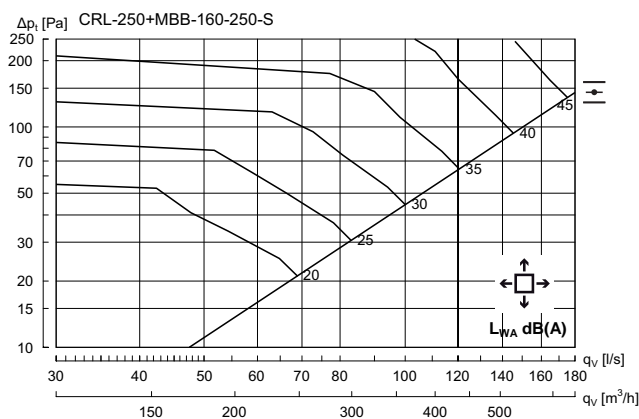

Hz	63	125	250	500	1K	2K	4K	8K
$K_{ok}$	11	6	1	-3	-5	-10	-15	-21

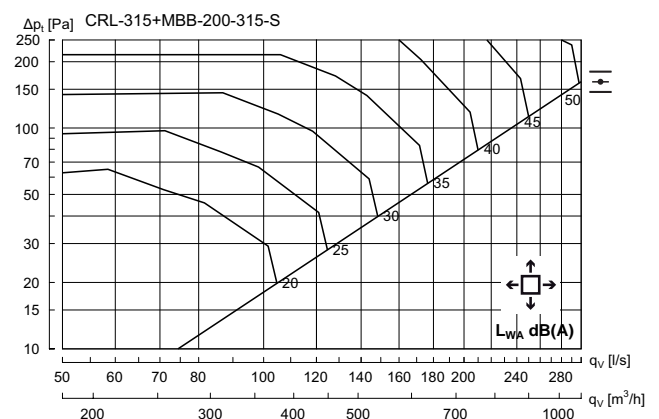

Hz	63	125	250	500	1K	2K	4K	8K
$K_{ok}$	11	7	0	-3	-6	-10	-16	-21

# Plain diffuser

# CRL

## Technical data

### CRL 400+ MBB - Supply air

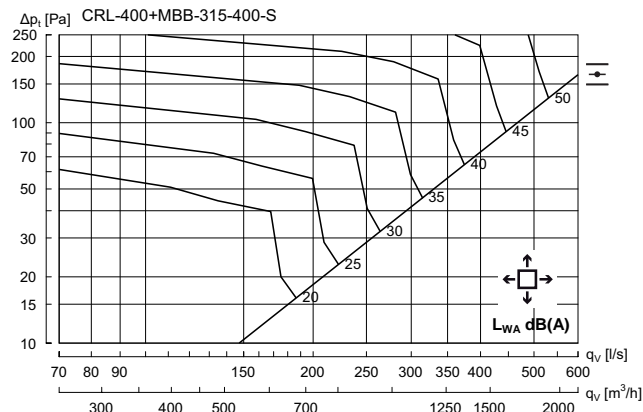

Hz	63	125	250	500	1K	2K	4K	8K
$K_{sk}$	11	3	0	-3	-5	-10	-14	-23

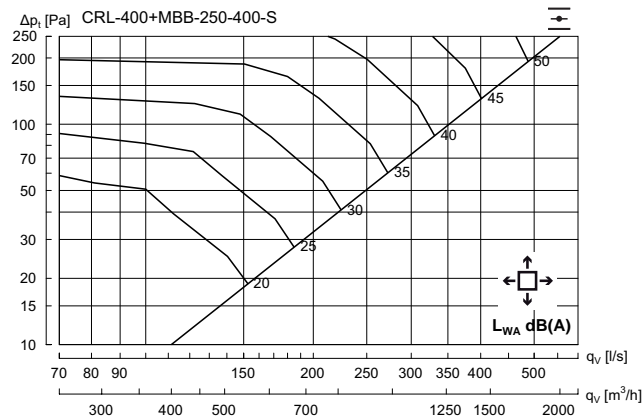

Hz	63	125	250	500	1K	2K	4K	8K
$K_{sk}$	8	4	-1	-3	-4	-10	-14	-20

### CRL + MBB - Supply air

Correction vertical supply air, sound power level ( $L_{WA}$ ) and pressure loss ( $\Delta p_t$ )

CRL + MBB		Correction factor	
duct	CRL	Vertical supply air	
$\varnothing d_1$	$\varnothing d_2$	$L_{WA}$	$\Delta p_t$
100	100	+ 6	x 1,3
100	125	+ 8	x 1,3
100	160	+ 3	x 1,1
125	125	+ 1	x 1
125	160	+ 8	x 1,2
125	200	+ 1	x 1
160	160	+ 10	x 1,5
160	200	+ 3	x 1,1
160	250	+ 0	x 1
200	200	+ 7	x 1,3
200	250	+ 0	x 1
200	315	+ 1	x 1
250	250	+ -2	x 1
250	315	+ 0	x 1
250	400	+ 0	x 1,1
315	315	+ -2	x 1,1
315	400	+ 3	x 1,2



# Plain diffuser

# CRL

## Technical data

### CRL without box - Exhaust air

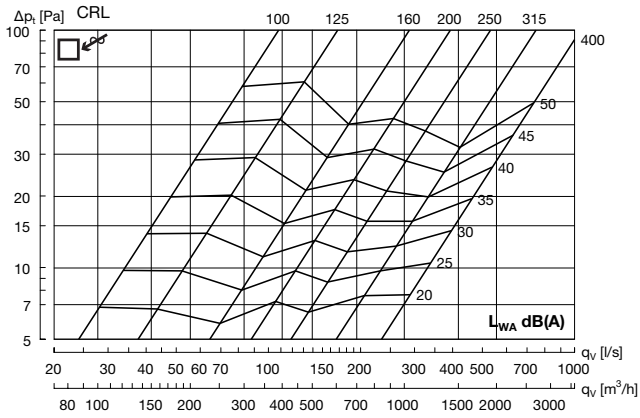

### CRL 100 + MBB - Exhaust air

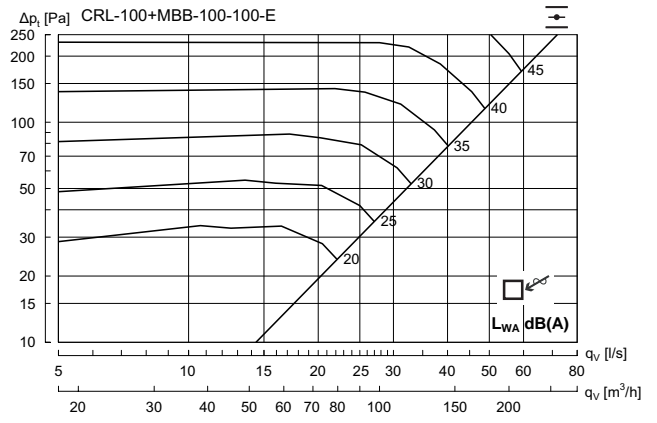

Hz	63	125	250	500	1K	2K	4K	8K
$K_{ok}$	11	0	2	-2	-6	-11	-15	-22

- 1
- 2
- 3
- 4
- 5
- 6
- 7
- 8
- 9
- 10
- 11
- 12
- 13
- 14
- 15
- 16
- 17
- 18

# Plain diffuser

# CRL

## Technical data

### CRL 125 + MBB - Exhaust air

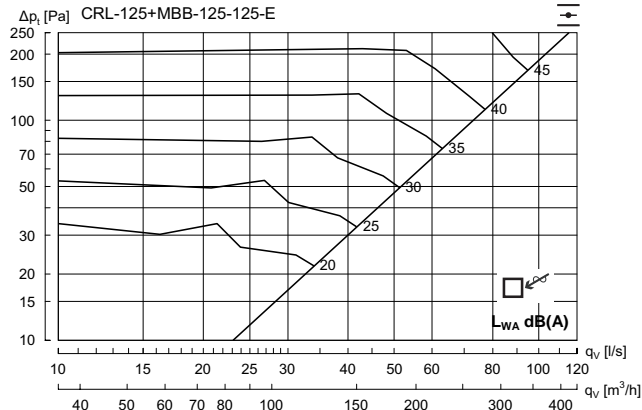

Hz	63	125	250	500	1K	2K	4K	8K
$K_{ok}$	14	5	-1	-3	-4	-12	-15	-21

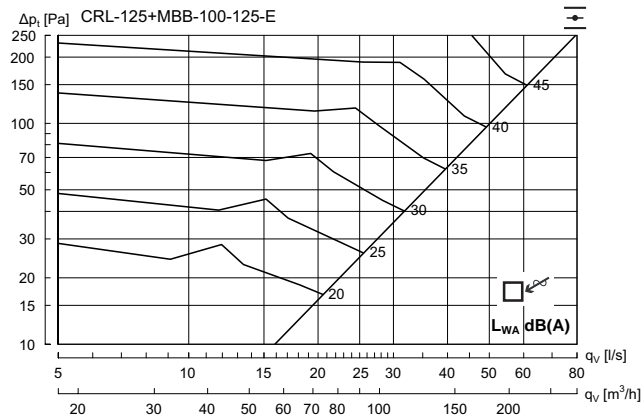

Hz	63	125	250	500	1K	2K	4K	8K
$K_{ok}$	13	0	4	-3	-8	-11	-17	-22

### CRL 160 + MBB - Exhaust air

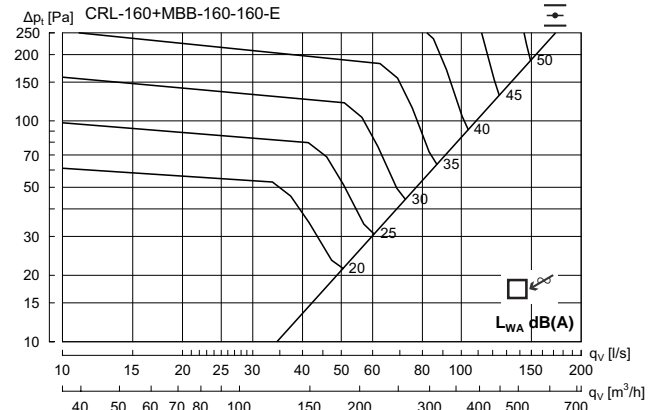

Hz	63	125	250	500	1K	2K	4K	8K
$K_{ok}$	14	4	-1	-4	-4	-10	-16	-24

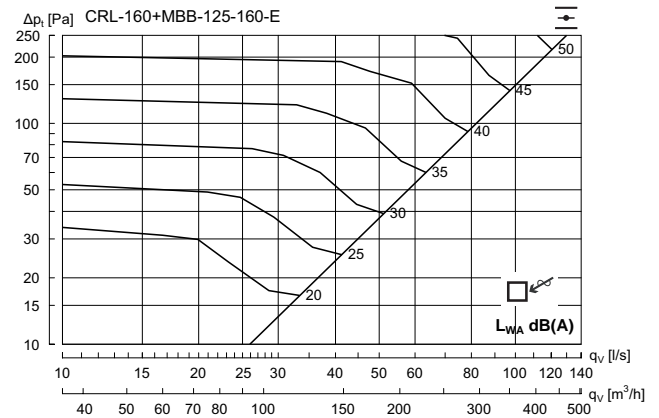

Hz	63	125	250	500	1K	2K	4K	8K
$K_{ok}$	13	6	1	-3	-5	-12	-15	-21

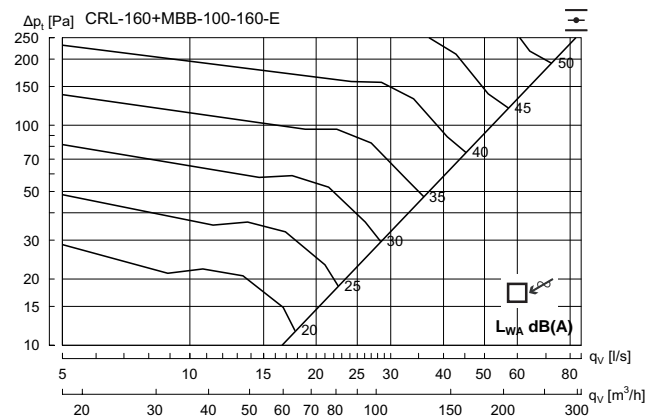

Hz	63	125	250	500	1K	2K	4K	8K
$K_{ok}$	13	0	5	-3	-9	-12	-19	-23

# Plain diffuser

# CRL

## Technical data

### CRL 200 + MBB - Exhaust air

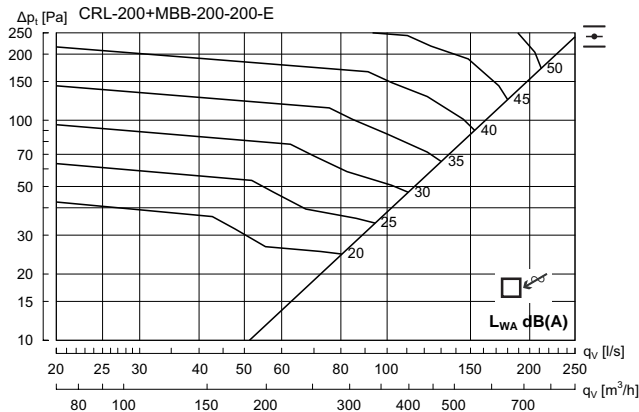

Hz	63	125	250	500	1K	2K	4K	8K
$K_{ok}$	15	5	-1	-3	-6	-9	-16	-25

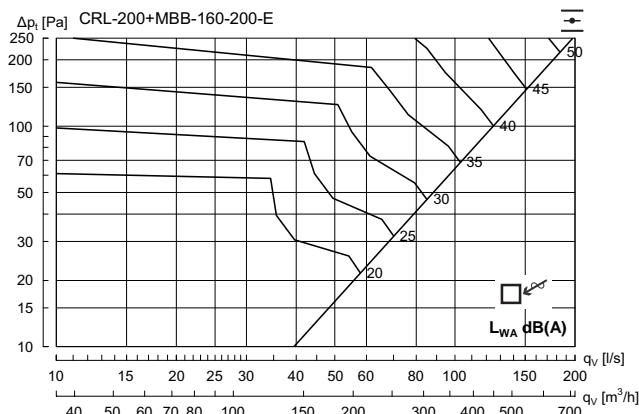

Hz	63	125	250	500	1K	2K	4K	8K
$K_{ok}$	14	5	0	-3	-5	-9	-15	-20

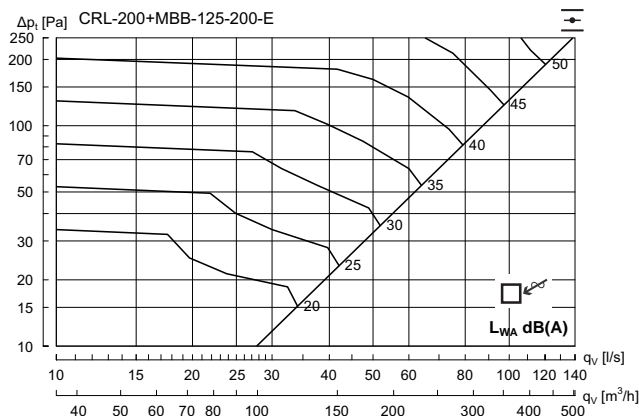

Hz	63	125	250	500	1K	2K	4K	8K
$K_{ok}$	9	2	1	-2	-5	-9	-14	-19

### CRL 250 + MBB - Exhaust air

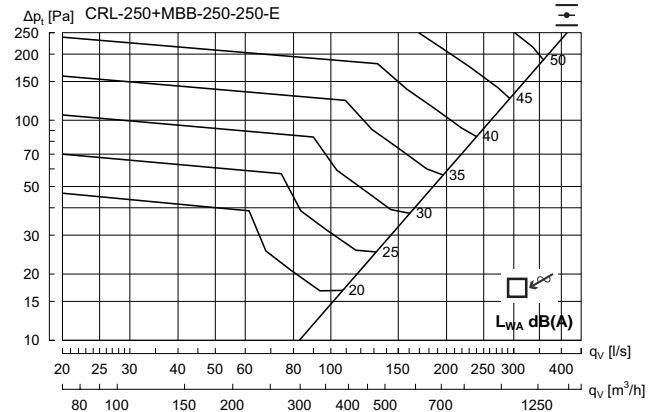

Hz	63	125	250	500	1K	2K	4K	8K
$K_{ok}$	11	6	2	-2	-7	-11	-15	-24

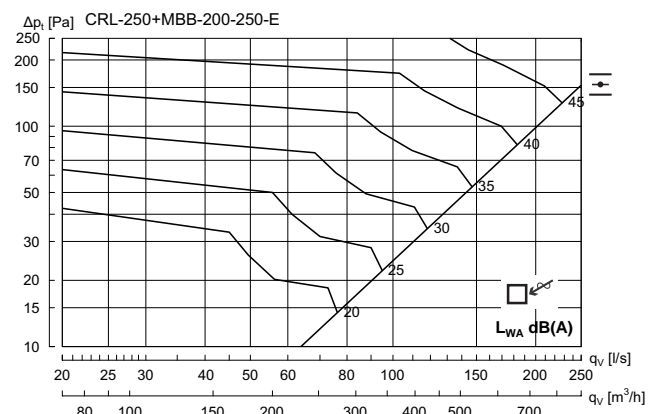

Hz	63	125	250	500	1K	2K	4K	8K
$K_{ok}$	13	5	1	-3	-6	-10	-13	-22

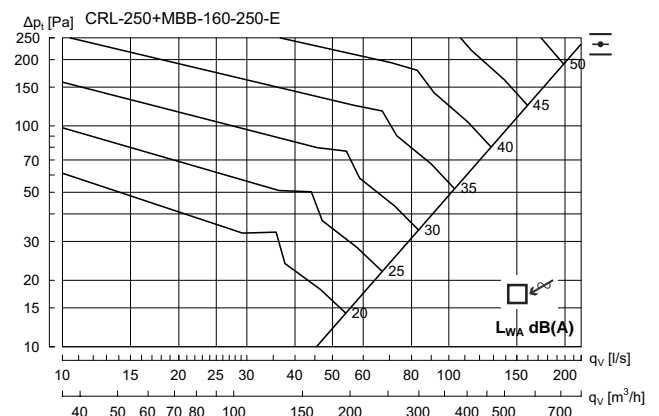

Hz	63	125	250	500	1K	2K	4K	8K
$K_{ok}$	13	5	1	-3	-5	-11	-14	-20



# Plain diffuser

# CRL

## Technical data

### CRL 315 + MBB - Exhaust air

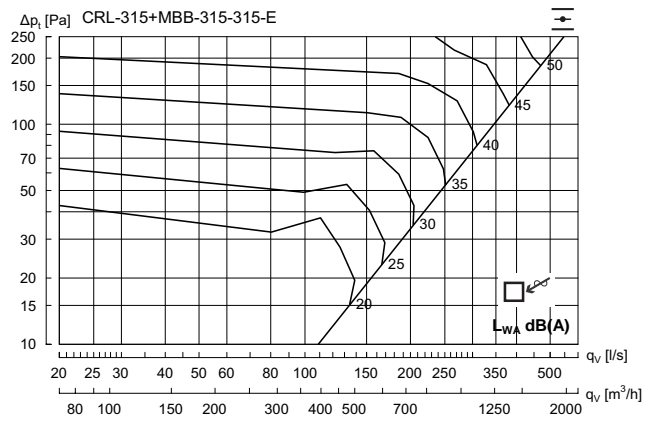

Hz	63	125	250	500	1K	2K	4K	8K
$K_{ok}$	13	5	2	-3	-6	-10	-15	-25

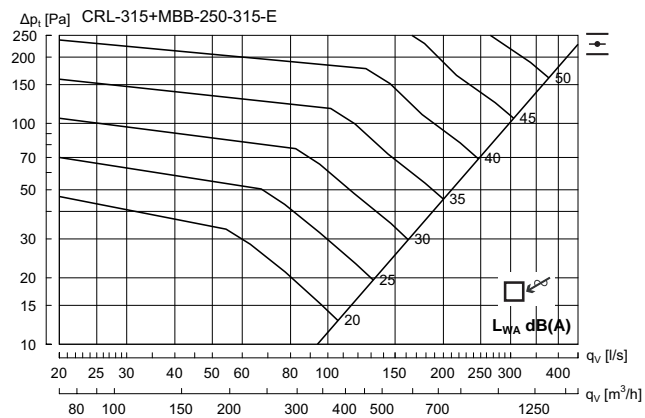

Hz	63	125	250	500	1K	2K	4K	8K
$K_{ok}$	9	5	2	-3	-6	-10	-16	-22

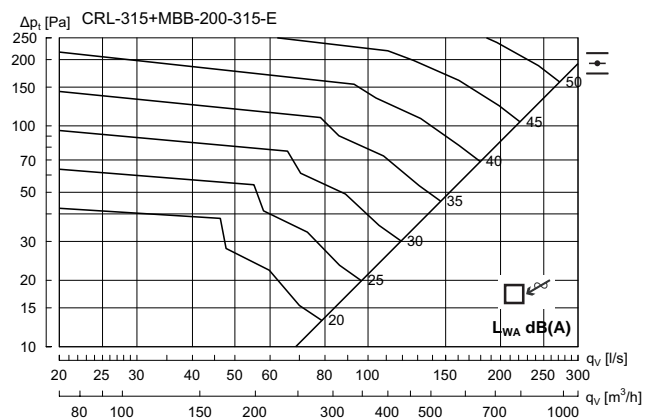

Hz	63	125	250	500	1K	2K	4K	8K
$K_{ok}$	13	5	0	-3	-5	-10	-15	-22

### CRL 400 + MBB - Exhaust air

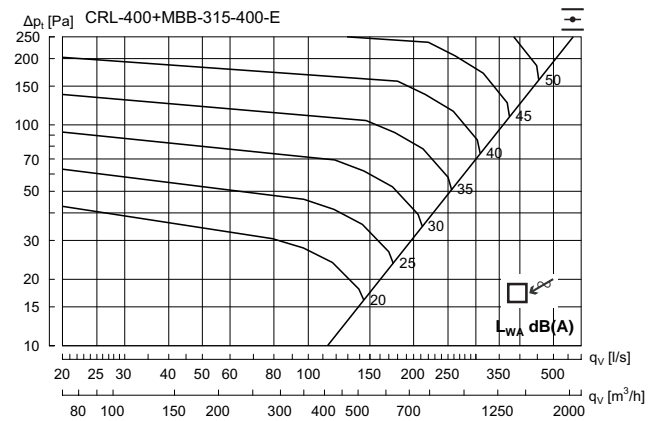

Hz	63	125	250	500	1K	2K	4K	8K
$K_{ok}$	11	5	2	-2	-7	-11	-15	-25

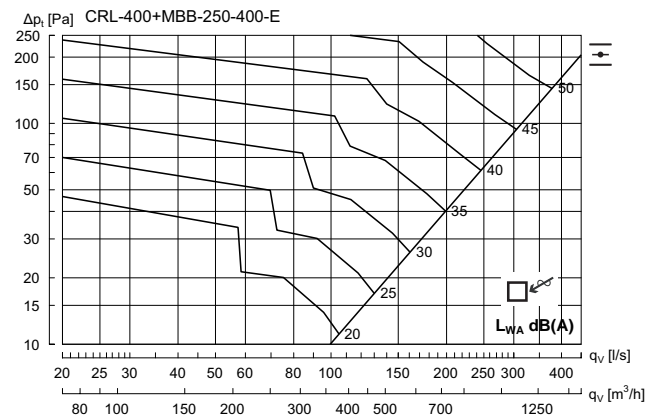

Hz	63	125	250	500	1K	2K	4K	8K
$K_{ok}$	9	6	2	-2	-6	-12	-16	-24