

ID	Description	Date	By	Appr.
A				

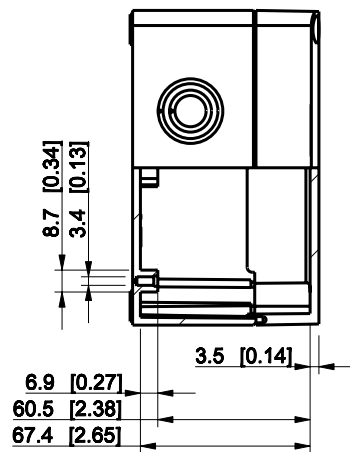
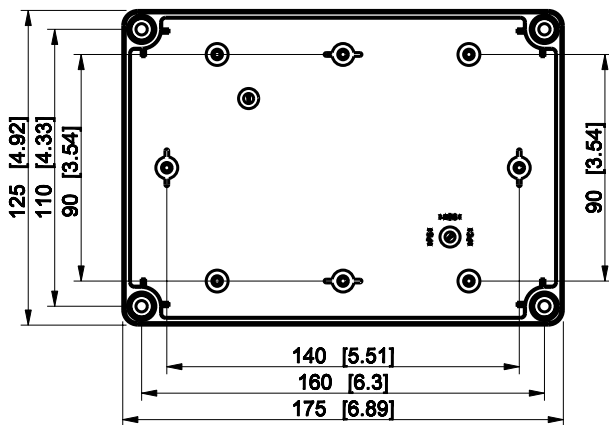
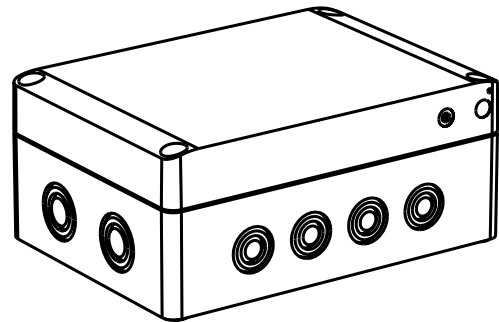
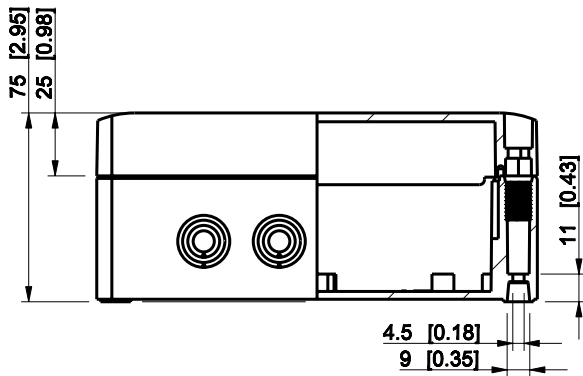

Dimensions in mm [inches]

Material: Polycarbonate, fiberglass-reinforced	Color: RAL 7035
--	-----------------

Supplier:	Tool No:	Weight [kg]: 0.34	Volume:
-----------	----------	-------------------	---------

**ENSTO**  
ENSTO CONTROL OY

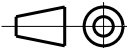

**SPCM131808G**

Scale	Date	08.12.08
1:3	By	PKos
-	Checked	
-	Ctrl	

Replaces:
Replaced:
Drw No: - A
Ref: Cubo S
Code: SPCM131808G
Sheet No:

model SPCM131808G PART  
drawing CUBOS DRAWING