

Ultra Installation System

Ultra-efficient installation solutions

Cable Management System



Schneider
Electric

Efficient use of time and money is good for you, and good for your customers.



Ultra installation system is a simple and smart installation system in environment-friendly materials.



P127008

Ultra-efficient solutions for modern buildings and homes

Ultra is a new, simple and smart installation system, covering most installation needs in an efficient way. The range includes both installation trunking, mini-trunking, cable distribution trunking skirting trunking, on-floor trunking in high-grade PVC and floor boxes. Ultra is the perfect and cost-efficient alternative when you need an easy-to-install system, with a limited number of references, making both ordering and handling on site very simple. If you need a complete and high-end installation solution with unlimited possibilities, our OptiLine installation system should be your choice.



All Ultra products are RoHS compliant.



P127023



P127435

Customer benefits

- Made of cadmium and lead-free high-grade PVC that is both easy to clean and resistant to impact
- Installation trunking with adaptors for Altira and Ultra 45x45 module wiring devices and c/c 60 wiring devices
- Mini-trunking and skirting trunking with dedicated installation boxes and adaptors for Altira and Ultra 45x45 module and c/c 60 mm wiring devices
- Comprehensive range of Floor boxes and accessories in several sizes for various applications. suitable for Altira, Ultra and Unica wiring devices
- All Ultra products are approved by all relevant authorities
- Ultra is part of the total Schneider Electric solution for electrical distribution, network connectivity, building automation and energy efficiency



Ultra installation trunking

Ultra installation trunking is very flexible and includes adaptors for Altira wiring devices and accessories to solve all types of installation needs. Corners, bends, T-pieces, branching pieces, adaptors etc are made of halogen-free ABS. The trunking is made of self-extinguishing, cadmium and lead-free high-grade PVC, with a very good surface finish.



Ultra complies with the standards EN 50085-1 and EN 50085-2-1. The products also satisfy the provisions for CE marking according to the European Directive 2006/95/CE.

Three sizes, several possibilities

Ultra installation trunking is available in three sizes; 101x34 and 101x50 mm with one compartment, and 151x50 mm with one or two compartments (the second compartment is dedicated for network cables).

The 75 mm front opening allows 45x45 module and c/c 60 mm wiring devices to be mounted by using adaptors. The trunking base has pre-punched mounting holes every 23rd cm to make the installation fast and secure.

All sizes and all accessories have a symmetrical design to guarantee a correct installation, independent of mounting direction.



A complete trunking on one reference number

Ultra installation trunking is delivered complete on only one reference number to make ordering and handling easy. Trunking base, partition wall (151x50) and two snap-fitted front covers are included.



- 1 Adaptor for 1-module wiring device
- 2 Branching piece
- 3 Bend 90°
- 4 Adaptor for 3-module wiring devices
- 5 Internal corner
- 6 Adaptor for 2-module wiring devices
- 7 External corner
- 8 T-piece
- 9 Adaptor for 4-module wiring devices



Ultra is simple and fast to install. All accessories are designed for easy click-in mounting.



High safety

The trunking is IP40 and IK07 classified. It is therefore safe and impact resistant.



Click-in accessories

All accessories are designed for easy click-in mounting without tools and can be mounted after the installation of the trunking base. The picture shows the smart joint cover piece.



Adjustable corners

The corners are delivered in one piece. It is possible to cut the internal edge of the corner without interfering with the function, to perfectly fit the building construction deviations.



Protective foil

Protective foil on both sides of the trunking base and on the front covers prevents from damages. Easy to remove when the installation is finished.



Pre-punched holes

The trunking base has pre-punched oval mounting holes in two directions every 23rd cm to make the installation fast and secure.



Cable retainer

The smart cable retainer keeps all the cables in place in the trunking during the installation. Can remain in place also when the front covers are mounted and the installation is in use.



Adaptors

Adaptors for 1, 2, 3 and 4 modules of Altira 45x45 wiring devices and for c/c 60 wiring devices. The front plates overlap the trunking front, giving a neat final result.









Wiring devices for all needs

Ultra together with Altira wiring devices gives optimal function and design.

Ultra Installation trunking

Installation trunking including separate front cover(s)		Front cover	Internal corner	External corner	Bend 90°	T-piece	Joint cover piece, kit	
With one compartment	Ref. No	Ref. No.	Ref. No	Ref. No.	Ref. No.	Ref. No.	Ref. No.	
	101x34	ETK10134E	75 mm, ETK151505	ETK10120E ETK10120D*	ETK10130E ETK10130D*	ETK10140E ETK10140D*	ETK10151E ETK10151D*	ETK10170E ETK10170D*
	101x50	ETK10150E						
	151x50	ETK15150	120 mm, ETK151501	ETK15120	ETK15130	ETK15140	ETK15153	ETK15170
	151x50	ETK151502 Without front cover						
With two compartments								
	151x50	ISM17010 Including partition wall	40 mm, ETK151503 75 mm, ETK151505 120 mm ETK151501	ETK15120	ETK15130	ETK15140	ETK15153	ETK151702
	151x50	ETK151502 Without front cover						

* DIY range

 Stop end	 Cable shelf	 Partition wall	 Cable retainer	 Branching piece	 Adaptors for wiring devices	
Ref. No.	Ref. No.	Ref. No.	Ref. No.	Ref. No.	Ref. No.	Ref. No.
ETK100060E ETK10060D*	ETK100095		ETK10171E	ETK10154E for 101x34-101x50	1-4 module adaptors, see page 15-16	
ETK150060	ETK100092E		ETK15171	ETK15154 for 151x50-101x50		
ETK150060	ETK100092E	ETK151504		ETK15154 for 151x50-101x50	1-4 module adaptors, see page 15-16	

Installation trunking Ultra

Type	Colour	Dimensions A/B/C (mm)	Qty per package	EAN code	Ref. No.
Installation trunking with one compartment					
Installation trunking made up by a trunking base with one compartment and a snap-fit 75 mm front cover. The trunking base has pre-punched mounting holes on every 23 rd cm and can be provided with cable shelves. Suitable for power and low voltage cables. Supplied in 2 m lengths under protective foil. Material: PVC.					
Trunking 101x34	White RAL 9010	101/34/2000	24 m	8690495056457	ETK10134E
Trunking 101x50	White RAL 9010	101/50/2000	16 m	8698150179800	ETK10150E
Installation trunking made up by a trunking base with one compartment and a snap-fit 120 mm front cover. The trunking base has pre-punched mounting holes on every 23rd cm and can be provided with cable shelves. Suitable for power and low voltage cables. Supplied in 2 m lengths under protective foil. Material: PVC.					
Trunking 151x50	White RAL 9010	151/50/2000	8 m	8698150116119	ETK15150
Installation trunking like the above but without front cover. Material: PVC.					
Trunking 151x50	White RAL 9010	151/50/2000	8 m	8698150116140	ETK15150Z
Installation trunking with two compartments					
Installation trunking made up by a trunking base with two compartments, a partition wall between the compartments and two snap-fit front covers, one 75 mm and one 40 mm. The trunking base has pre-punched mounting holes on every 23 rd cm and can be provided with cable shelves. The 75 mm front opening allows 45x45 module wiring devices and modular devices to be mounted by using adaptors. Suitable for power and low voltage cables. Supplied unassembled in 2 m lengths, with the trunking base and the front covers under separate protective foil. Material: PVC.					
Trunking 151x50	White RAL 9010	151/50/2000	8 m	3606480426810	ISM17010
Front cover					
Front cover to be snap-fitted in installation trunking. Supplied in 2 m lengths under protective foil. Material: PVC.					
Front cover 40 mm, 151x50	White RAL 9010	41/9/2000	48 m	8698150116164	ETK151503
Front cover 75 mm, 151x50	White RAL 9010	75/9/2000	16 m	8698150116201	ETK151505
Front cover 120 mm, 151x50	White RAL 9010	119/9/2000	16 m	8698150116126	ETK151501
Accessories Installation trunking Ultra					
Internal corner, adjustable					
Internal corner to be snapped onto the installation trunking base. Adjustability: $\pm 5^\circ$. Material: ABS.					
Internal corner 101x34/50, adjustable	White RAL 9010	110/106/106	5	8690495055153	ETK10120E
Internal corner 151x50, adjustable	White RAL 9010	160/106/106	5	8690495055931	ETK15120
Internal corner, adjustable, DIY					
Internal corner to be snapped onto the installation trunking base. Adjustability: $\pm 5^\circ$. For DIY. Material: ABS.					
Internal corner 101x34/50, adjustable, DIY	White RAL 9010	110/106/106	1	3606480572050	ETK10120D
External corner, adjustable					
External corner to be snapped onto the installation trunking base. Adjustability: $\pm 5^\circ$. Material: ABS.					
External corner 101x34/50, adjustable	White RAL 9010	110/98/102	5	8690495055184	ETK10130E
External corner 151x50, adjustable	White RAL 9010	160/98/102	5	8690495055900	ETK15130
External corner, adjustable, DIY					
External corner to be snapped onto the installation trunking base. Adjustability: $\pm 5^\circ$. For DIY. Material: ABS.					
External corner 101x34/50, adjustable, DIY	White RAL 9010	110/98/102	1	3606480572111	ETK10130D
Bend, 90°					
90 degree bend to be used in junctions between horizontal and vertical applications. To be snapped onto the installation trunking base. Material: ABS.					
Bend 90° 101x34/50	White RAL 9010	140/52/140	5	8690495055191	ETK10140E
Bend 90° 151x50	White RAL 9010	190/52/190	5	8690495055894	ETK15140

Accessories Installation trunking Ultra

Type	Colour	Dimensions A/B/C (mm)	Qty per package	EAN code	Ref. No.
Bend, 90°, DIY					
90 degree bend to be used in junctions between horizontal and vertical applications. To be snapped onto the installation trunking base. For DIY. Material: ABS.					
Bend 90° 101x34/50, DIY	White RAL 9010	140/52/140	2*	3606480572166	ETK10140D
T-piece					
T-piece to be used in T-junctions between installation trunking of the same size. To be snapped onto the installation trunking base. Material: ABS.					
T-Piece 101x34/50	White RAL 9010	138/52/171	5	8690495055207	ETK10151E
T-Piece 151x50	White RAL 9010	190/52/221	5	8690495055924	ETK15153
T-piece, DIY					
T-piece to be used in T-junctions between installation trunking of the same size. To be snapped onto the installation trunking base. For DIY. Material: ABS.					
T-Piece 101x34/50, DIY	White RAL 9010	138/52/171	1	3606480571862	ETK10151D
Joint cover piece, kit					
Joint cover piece, kit including three pieces, one upper, one lower, and one front piece. Intended to cover joints between installation trunking covers. To be fixed onto the installation trunking base. Material: ABS.					
Joint cover piece 101x34/50	White RAL 9010	104/52/32	10	8690495055160	ETK10170E
Joint cover piece 151x50 for 120 mm front cover	White RAL 9010	156/53/32	10	8690495055955	ETK15170
Joint cover piece 151x50 for 75 + 40 mm front cover	White RAL 9010	155/53/30	10	8690495055962	ETK15170Z
Joint cover piece, kit, DIY					
Joint cover piece, kit including three pieces, one upper, one lower, and one front piece. Intended to cover joints between installation trunking covers. To be fixed onto the installation trunking base. For DIY. Material: ABS.					
Joint cover piece 101x34/50, DIY	White RAL 9010	104/52/32	2*	3606480571992	ETK10170D
Stop end					
Stop end to be snapped onto the end of the installation trunking base. Material: ABS.					
Stop end 101x34/50	White RAL 9010	101/13/52	10	8690495055214	ETK100060E
Stop end 151x50	White RAL 9010	155/17/52	10	8690495055917	ETK150060
Stop end, DIY					
Stop end to be snapped onto the end of the installation trunking base. For DIY. Material: ABS.					
Stop end 101x34/50, DIY	White RAL 9010	101/13/52	2*	3606480571930	ETK10060D
Cable shelf					
Single cable shelf to be mounted in the installation trunking base, providing separation between power and low voltage cables. Supplied in lengths of 2 m. Material: PVC.					
Cable shelf 101x34	White RAL 9010	28/12/2000	32 m	8698150100958	ETK100095
Cable shelf 101x50 and 151x50	White RAL 9010	43/15/2000	32 m	8698150116461	ETK100092E
Partition wall					
Partition wall to be mounted in 151x50 trunking in order to assemble wiring devices and provide separation between power and low voltage cables. Material: PVC.					
Partition wall 151x50	White RAL 9010	48/14/2000	24 m	8698150116188	ETK151504
Cable retainer					
Cable retainer to be snapped inside the installation trunking base to keep cables in place during the installation phase. Material: ABS.					
Cable retainer 101x34/50	White RAL 9010	9/30/81	10	8690495055177	ETK10171E
Cable retainer 151x50	White RAL 9010	11/30/125	10	8690495055948	ETK15171

* Each Ref.No. includes 2 pieces.

Accessories Installation trunking Ultra

Type	Colour	Dimensions A/B/C (mm)		Qty per package	EAN code	Ref. No.
Branching piece						
Branching piece to be used between installation trunking of different sizes. Material: ABS.						
Branching piece for 101x34 – 101x50	White RAL 9010	105/52/66		5	8690495055146	ETK10154E
Branching piece for 151x50 – 101x50	White RAL 9010	155/52/66		5	8690495055887	ETK15154
Adaptor for wiring devices						
Adaptor including front plate. Suitable for 45x45 module wiring devices, type Altira, Ultra and similar. Can only be snap-fitted into 75 mm front opening. Material: ABS.						
Adaptor for 1-module wiring device	White RAL 9010	85/22/80		5	8690495056495	ETK10198E
Adaptor for 2-module wiring devices	White RAL 9010	85/22/120		5	8690495056525	ETK10197E
Adaptor for 3-module wiring devices	White RAL 9010	85/22/170		5	8690495056518	ETK10187E
Adaptor for 4-module wiring devices	White RAL 9010	85/22/215		5	8690495056501	ETK10183E
Universal adaptor						
Universal adaptor including two screws. Suitable for c/c 60 mm wiring devices. Can only be snap-fitted into 75 mm front opening. Material: ABS.						
Universal adaptor, single	White RAL 9010	88/17/112		5	8698150101948	ETK10194
Universal adaptor, double	White RAL 9010	88/17/183		5	8698150101863	ETK10186
Universal adaptor, triple	White RAL 9010	88/17/255		5	8698150101818	ETK10181
Universal adaptor, single, high	White RAL 9010	88/25/112		5	8698150101917	ETK10191
Universal adaptor, double, high	White RAL 9010	88/28/183		5	8698150101962	ETK10196
Universal adaptor, triple, high	White RAL 9010	88/27/257		5	8698150101825	ETK10182
Socket outlets, Ultra						
Power socket outlet for 45x45 module earthed plug, with pin or side-earth and child protection. 250V 16A. Material: PC/ABS.						
Power socket outlet, pin-earthed	Red White	45/41/45		10	8690495056471 3606480517709	ETK21046E ETK21046EW
Power socket outlet, side-earthed	Red White	45/41/45		10	3606480517693 8690495056488	ETK21045ER ETK21045E
Socket outlet bridge						
Socket outlet bridge providing electrical connection between two socket outlets without wiring. Material: PA6 with 20% fibre glass.						
Socket outlet bridge 45x45	Grey RAL 7035	7/25/70		15	8690495056464	ETK21454E

P12622Z



P127139



P127138



P127137



P127136



P126235



P127140



P127841



P127842



P141039



Protective foil



Pre-punched mounting holes



Generic picture

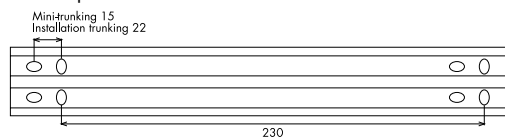

Technical and Material data

PVC	Characteristics:	Rigid, self-extinguishing, cadmium-free, lead-free
	Colour:	White RAL 9010
ABS	Characteristics:	Halogen-free
	Colours:	White RAL 9010
Degree of protection	IP40	
Temperature range	Min. storage and transportation temperature	-25°C
	Min. installation and application temperature	-5°C
	Max. application temperature	+60°C
Resistance to impact	2J (IK07)	
Delivery lengths	2 metres	
Standards and certificates	The product complies with the standards: • EN 50085-1:2005 • EN 50085-2-1:2006 The products also satisfy the provisions for CE marking according to the European Directive 2006/95/CE.	

Design and dimensions

101x34

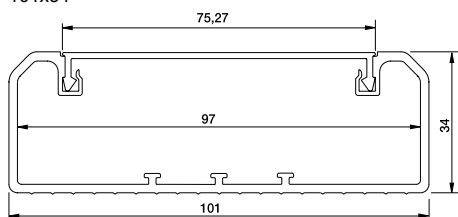

101x34 with snapped-in cable shelves

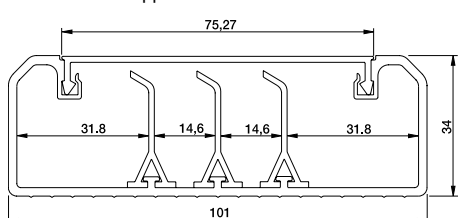

101x50

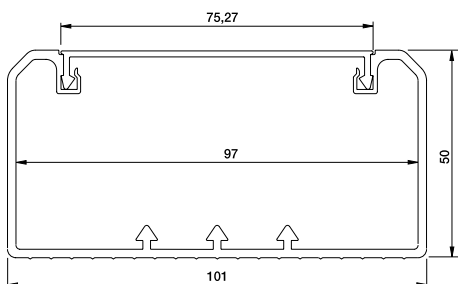

101x50 with snapped-in cable shelf

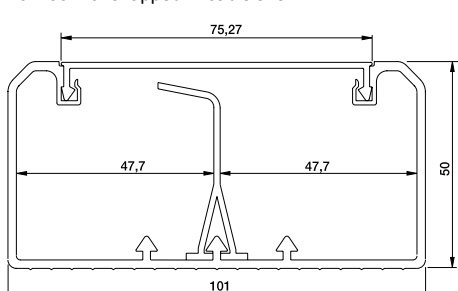

151x50

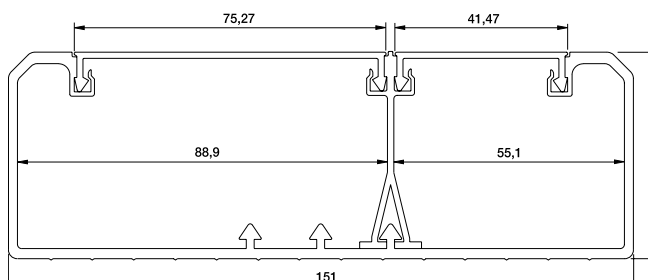
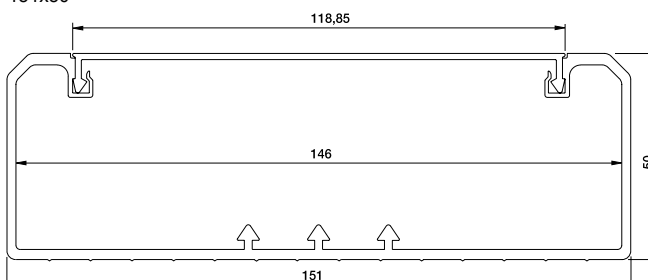

151x50 with snapped-in cable shelf

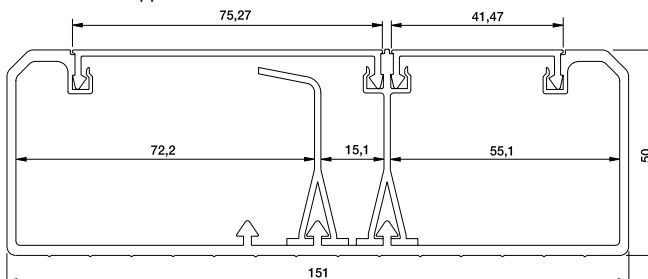



P126669



P127026



P127024



P127023

Ultra mini-trunking

For wiring device adaption

Ultra mini-trunking is very suitable for minor installations in both offices and homes. Installation boxes for Altira wiring devices are easily mounted in the trunking base. Corners, bends, T-pieces, branching pieces, boxes, adaptors etc are made of ABS. The trunking is made of self-extinguishing, cadmium and lead-free high-grade PVC, with a very good surface finish.



Ultra complies with the standards EN 50085-1 and EN 50085-2-1. The products also satisfy the provisions for CE marking according to the European Directive 2006/95/CE.

Five sizes, several possibilities

Ultra mini-trunking is available in five sizes, from 21x12 to 74x21 mm.

Installation boxes with adaptors for 45x45 module and c/c 60 mm wiring devices are available in several sizes. The trunking base has pre-punched mounting holes every 23rd cm to make the installation fast and secure.

All sizes and all accessories have a symmetrical design to guarantee a correct installation, independent of mounting direction



P127027



- | | | |
|--------------------------------------|---------------------------------------|-------------------|
| 1 Stop end | 4 Adaptor for 3-module wiring devices | 7 External corner |
| 2 Adaptor for 1-module wiring device | 5 Internal corner | 8 T-piece |
| 3 Bend 90° | 6 Adaptor for 2-module wiring devices | |



Ultra is simple and fast to install. All accessories are designed for easy click-in mounting.



High safety

The trunking is IP40 and IK07 classified. It is therefore safe and impact resistant.



Click-in accessories

All accessories are designed for easy click-in mounting without tools and can be mounted after the installation of the trunking base.



Adjustable corners

The corners are delivered in one piece and are adjustable to perfectly fit the building construction deviations.



Box kit with adaptor for wiring devices

Installation box kit, including box, wiring device adaptor and fixing screws is available on one reference number. Each box can be used for all sizes of trunking – just cut the length of the feeding section to the right size.



U-shaped cover

The cover is U-shaped and conceals the trunking base. Gives a very nice appearance and a perfect final result.



Pre-punched holes

The trunking base has pre-punched oval mounting holes every 23rd cm to make the installation fast and secure.



Self-adhesive tape

Available also with self-adhesive tape for the two smallest sizes, 21x12 and 32x17 mm. Reduces installation time significantly.







Wiring devices for all needs





Ultra together with Altira wiring devices gives optimal function and design.

Choice guide

Mini-trunking for wiring device adaption

Mini-trunking Ultra for wiring device adaption





Mini-trunking for wiring device adaption		Internal corner	External corner	Bend 90°	T-piece	Joint cover piece
With one compartment	Ref. No	Ref. No.	Ref. No.	Ref. No.	Ref. No.	Ref. No.
 21x12 ETK21012	ETK21012	ETK20520	ETK20530	ETK20540	ETK20550	ETK20570
	21x12 Self-adhesive ETK21912					
 32x17 ETK32017	ETK32017	ETK32020	ETK32030	ETK32040	ETK32050	ETK32070
	32x17 Self-adhesive ETK32917					
With two compartments						
 40x17 ETK40017	ETK40017	ETK40020	ETK40030	ETK40040	ETK40050	ETK40070
With three compartments						
 60x21 ETK60021	ETK60021	ETK60020	ETK60030	ETK60040	ETK60050	ETK60070
	74x21 ETK74021					

 Stop end	 Cable retainer	 Branching piece	 Installation box kits for wiring devices
Ref. No.	Ref. No.	Ref. No	
ETK20560	ETK20571	for 21x12-60x21 ETK60022 for 21x12-74x21 ETK74022	Installation box kits for 1-3 module wiring devices, see page 18-19
ETK32060	ETK32071	for 32x17-60x21 ETK60032 for 32x17-74x21 ETK74032	
ETK40060	ETK40071	for 40x17-60x21 ETK60041 for 40x17-74x21 ETK74041	
ETK60060	ETK60071		
ETK74060	ETK74071		



Range

Mini-trunking for wiring device adaption

Mini-trunking Ultra for wiring device adaptation

Type	Colour	Dimensions A/B/C (mm)	Qty per package	EAN code	Ref. No.		
Mini-trunking with one compartment							
One-compartment mini-trunking made up by a base profile with pre-punched mounting holes on every 23 rd cm and a snap-fit front cover. Available with and without self-adhesive fixing tape. Suitable for power and low voltage cables. Supplied in 2 m lengths. Material: PVC.							
P126545		Mini-trunking 21x12	White RAL 9010	21/12/2000	128 m	8698150210121	ETK21012
		Mini-trunking 21x12 self-adhesive	White RAL 9010	21/12/2000	128 m	8698150219124	ETK21912
P126546		Mini-trunking 32x17	White RAL 9010	32/17/2000	60 m	8698150320172	ETK32017
		Mini-trunking 32x17 self-adhesive	White RAL 9010	32/17/2000	60 m	8698150329175	ETK32917
Mini-trunking with two compartments							
Two-compartment mini-trunking made up by a base profile with pre-punched mounting holes on every 23 rd cm and a snap-fit front cover. The compartments are separated by an integrated partition wall. Suitable for power and low voltage cables. Supplied in 2 m lengths. Material: PVC.							
P126215		Mini-trunking 40x17	White RAL 9010	40/17/2000	60 m	8698150400171	ETK40017
Mini-trunking with three compartments							
Three-compartment mini-trunking made up by a base profile with pre-punched mounting holes on every 23 rd cm and a snap-fit front cover. The compartments are separated by integrated partition walls. Suitable for power and low voltage cables. Supplied in 2 m lengths. Material: PVC.							
P126216		Mini-trunking 60x21	White RAL 9010	60/21/2000	40 m	8698150600212	ETK60021
		Mini-trunking 74x21	White RAL 9010	74/21/2000	24 m	8698150740215	ETK74021

Accessories Mini-trunking Ultra for wiring device adaptation

Internal corner, adjustable							
Internal corner to be snapped onto the mini-trunking base. Adjustability: $\pm 5^\circ$. Material: ABS.							
P126207		Internal corner 21x12, adjustable	White RAL 9010	23/41.5/41.5	20	8698150205202	ETK20520
		Internal corner 32x17, adjustable	White RAL 9010	20/55/55	20	8698150320202	ETK32020
		Internal corner 40x17, adjustable	White RAL 9010	47/60/60	20	8698150400201	ETK40020
		Internal corner 60x21, adjustable,	White RAL 9010	65/46/47	10	8698150600205	ETK60020
		Internal corner 74x21, adjustable	White RAL 9010	79/47/48	10	8698150740208	ETK74020
External corner, adjustable							
External corner to be snapped onto the mini-trunking base. Adjustability: $\pm 5^\circ$. Material: ABS.							
P126208		External corner 21x12, adjustable	White RAL 9010	22/40.5/40.5	20	8698150205301	ETK20530
		External corner 32x17, adjustable	White RAL 9010	20/55/55.5	20	8698150320301	ETK32030
		External corner 40x17, adjustable	White RAL 9010	46.5/41/44	20	8698150400300	ETK40030
		External corner 60x21, adjustable	White RAL 9010	65/46/46	10	8698150600304	ETK60030
		External corner 74x21, adjustable	White RAL 9010	78.5/48/49	10	8698150740307	ETK74030
Bend, 90°							
90 degree bend to be used in junctions between horizontal and vertical applications. To be snapped onto the mini-trunking base. Material: ABS.							
P126209		Bend 90° 21x12	White RAL 9010	14/35/35	10	8698150205400	ETK20540
		Bend 90° 32x17	White RAL 9010	19/55/55	10	8698150320400	ETK32040
		Bend 90° 40x17	White RAL 9010	16/66/66	10	8698150400409	ETK40040
		Bend 90° 60x21	White RAL 9010	21/92/92	10	8698150600403	ETK60040
		Bend 90° 74x21	White RAL 9010	23/104/103	10	8698150740406	ETK74040







Accessories Mini-trunking Ultra for wiring device adaptation

Type	Colour	Dimensions A/B/C (mm)		Qty per package	EAN code	Ref. No.
T-piece						
T-piece to be used in T-junctions between mini-trunking of the same size. To be snapped onto the mini-trunking base. Material: ABS.						
T-Piece 21x12	White RAL 9010	14/35/45		10	8698150205509	ETK20550
T-Piece 32x17	White RAL 9010	19/55/76		10	8698150320509	ETK32050
T-Piece 40x17	White RAL 9010	16/66/92		10	8698150400508	ETK40050
T-Piece 60x21	White RAL 9010	23/85/115		10	8698150600502	ETK60050
T-Piece 74x21	White RAL 9010	23/104/125		10	8698150740505	ETK74050
Joint cover piece						
Joint cover piece to cover joints between mini-trunking covers. To be snapped onto the mini-trunking base. Material: ABS.						
Joint cover piece 21x12	White RAL 9010	23/14/15		20	8698150205707	ETK20570
Joint cover piece 32x17	White RAL 9010	35/20/16		20	8698150320707	ETK32070
Joint cover piece 40x17	White RAL 9010	41/21/16		20	8698150400706	ETK40070
Joint cover piece 60x21	White RAL 9010	62/23/16		20	8698150600700	ETK60070
Joint cover piece 74x21	White RAL 9010	78/23/26		20	8698150740703	ETK74070
Stop end						
Stop end to be snapped onto the end of the mini-trunking base. Material: ABS.						
Stop end 21x12	White RAL 9010	23/13/7		20	8698150205608	ETK20560
Stop end 32x17	White RAL 9010	33.5/19/8		20	8698150320608	ETK32060
Stop end 40x17	White RAL 9010	42/18/8.5		20	8698150400607	ETK40060
Stop end 60x21	White RAL 9010	65/24/10		20	8698150600601	ETK60060
Stop end 74x21	White RAL 9010	78/23/10		20	8698150740604	ETK74060
Cable retainer						
Cable retainer to be snapped inside the mini-trunking base to keep cables in place during the installation phase. Material: ABS.						
Cable retainer 21x12	White RAL 9010	3.5/15/26		20	8698150205714	ETK20571
Cable retainer 32x17	White RAL 9010	3.5/25/27		20	8698150320714	ETK32071
Cable retainer 40x17	White RAL 9010	3.5/33/27		20	8698150400713	ETK40071
Cable retainer 60x21	White RAL 9010	4.5/52.5/32		20	8698150600717	ETK60071
Cable retainer 74x21	White RAL 9010	3.5/67/39.5		20	8698150740710	ETK74071
Branching piece						
Branching piece to be used in T-junctions between mini-trunking of different sizes. Material: ABS.						
Branching piece for 21x12 – 60x21	White RAL 9010	86/23/105		5	8698150600229	ETK60022
Branching piece for 21x12 – 74x21	White RAL 9010	101/23/104		5	8698150740222	ETK74022
Branching piece for 32x17 – 60x21	White RAL 9010	86/23/105		5	8698150600328	ETK60032
Branching piece for 32x17 – 74x21	White RAL 9010	101/23/104		5	8698150740321	ETK74032
Branching piece for 40x17 – 60x21	White RAL 9010	86/23/105		5	8698150600410	ETK60041
Branching piece for 40x17 – 74x21	White RAL 9010	101/23/104		5	8698150740413	ETK74041
Universal installation box kit						
Installation box kit including installation box, adaptor and fixing screws. Suitable for c/c 60 mm wiring devices. Material: ABS.						
Universal installation box kit, single	White RAL 9010	40/92/86		5	8698150205806	ETK20580
Universal installation box kit, double	White RAL 9010	40/92/156		5	8698150205967	ETK20596

Range

Mini-trunking for wiring device adaption

Accessories Mini-trunking Ultra for wiring device adaptation

Type	Colour	Dimensions A/B/C (mm)		Qty per package	EAN code	Ref. No.
Installation box kit						
Installation box kit including installation box, adaptor and fixing screws. Suitable for 45x45 module wiring devices. Material: ABS.						
P126218 	Installation box kit, 1-module wiring device	White RAL 9010	50/86/96	4	8698150205981	ETK20598
P126219 	Installation box kit, 2-module wiring device	White RAL 9010	50/92/114	5	8698150206803	ETK20680
P126217 	Installation box kit, 3-module wiring device	White RAL 9010	50/90.5/156	5	8698150205974	ETK20597
Socket outlets, Ultra						
Power socket outlet for 45x45 module earthed plug, with pin or side-earth and child protection. 250V 16A. Material: PC/ABS.						
P127841 	Power socket outlet, pin-earthed	Red White	45/41/45	10	8690495056471 3606480517709	ETK21046E ETK21046EW
P127842 	Power socket outlet, side-earthed	Red White	45/41/45	10	3606480517693 8690495056488	ETK21045ER ETK21045E
Socket outlet bridge						
Socket outlet bridge providing electrical connection between two socket outlets without wiring. Material: PA6 with 20% fibre glass.						
P141299 	Socket outlet bridge 45x45	Grey RAL 7035	7/25/70	15	8690495056464	ETK214546

Technical description

Mini-trunking for wiring device adaption

Pre-punched mounting holes



Generic picture

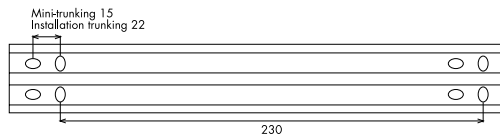

Technical and Material data

PVC	Characteristics:	Rigid, self-extinguishing, cadmium-free, lead-free
	Colour:	White RAL 9010
ABS	Characteristics:	Halogen-free
	Colours:	White RAL 9010
Degree of protection	IP40	
Temperature range	Min. storage and transportation temperature	-25°C
	Min. installation and application temperature	-5°C
	Max. application temperature	+60°C
Resistance to impact	2J (IK07)	
Delivery lengths	2 metres	
Standards and certificates	The product complies with the standards:	
	<ul style="list-style-type: none"> • EN 50085-1:2005 • EN 50085-2-1:2006 	
	The products also satisfy the provisions for CE marking according to the European Directive 2006/95/CE.	

Design and dimensions

21x12

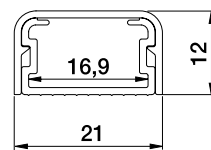

32x17

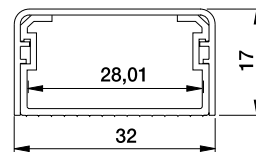

40x17

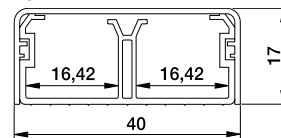

60x21

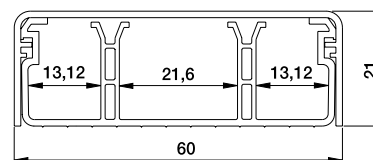

74x21

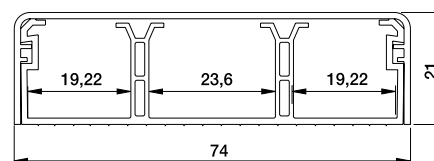



Ultra Skirting trunking

Ultra Skirting trunking is a very versatile solution for installation at floor level. It includes adaptors for Altira and Ultra wiring devices and accessories for all kind of installation needs. Corners, joint cover pieces, stop ends and adaptors are made of halogen free ABS. The trunking is made of self-extinguishing cadmium and lead-free high grade PVC, with a very good surface finish.



Ultra complies with the standards EN 50085-1 and EN 50085-2-1. The products also satisfy the provisions for CE marking according to the European Directive 2006/95/CE.

Three compartment skirting trunking.

Ultra Skirting trunking has a snap-fit cover for easy installation.

Suitable for both power and low voltage cables.

Supplied in 2 meter lengths.





P141467



P141466



Ultra is simple and fast to install. All accessories are designed for easy click-in mounting.



P126871

High safety

The trunking is IP40 and IK07 classified. It is therefore safe and impact resistant.



P126872

Click-in accessories

All accessories are designed for easy click-in mounting without tools and can be mounted after the installation of the trunking base.



P126877

Adjustable corners

The corners are delivered in one piece and are adjustable to perfectly fit the building construction deviations.



P127143

Box kit with adaptor for wiring devices

Installation box kit, including box, wiring device adaptor and fixing screws is available on one reference number. Each box can be used for all sizes of trunking – just cut the length of the feeding section to the right size.



P127144

U-shaped cover

The cover is U-shaped and conceals the trunking base. Gives a very nice appearance and a perfect final result.



P126870

Pre-punched holes

The trunking base has pre-punched oval mounting holes every 23rd cm to make the installation fast and secure.









P126332

Wiring devices for all needs

Altira together with Ultra wiring devices gives optimal function and design.

Choice guide

Skirting trunking









Skirting trunking						
						
		Internal corner	External corner	Joint cover piece	Stop end	Installation box kit for wiring devices
Size	Ref. No	Ref. No.	Ref. No.	Ref. No.	Ref. No.	Ref. No.
Skirting 70x20 with front cover	ETK70221	ETK70220 ETK70220D*	ETK70230 ETK70230D*	ETK70270 ETK70270D*	ETK70262 ETK70262D*	Installation box kits for universal or modular wiring devices (see page 23-24)

* DIY range

Skirting trunking Ultra







Type	Colour	Dimensions A/B/C (mm)	Qty per package	EAN code	Ref. No.
Skirting trunking					
Three-compartment skirting trunking made up by a base profile with pre-punched mounting holes on every 23 rd cm and a snap-fit front cover. Suitable for power and low voltage cables. Supplied in 2 m lengths. Material: PVC.					
Skirting trunking 70x20	White RAL 9010	70/20/2000	30 m	8698150702213	ETK70221

Accessories skirting trunking Ultra

P127837		Internal corner, adjustable					
		Adjustable internal corner to be snapped onto the skirting trunking base. Adjustability: ±5°. Material: ABS.					
		Internal corner 70x20	White RAL 9010	74/50/50	10	8698150702206	ETK70220
P127837		Internal corner, adjustable, DIY					
		Adjustable internal corner to be snapped onto the skirting trunking base. Adjustability: ±5°. For DIY. Material: ABS.					
		Internal corner 70x20, DIY	White RAL 9010	74/50/50	1	3606480572005	ETK70220D
P127838		External corner, adjustable					
		Adjustable external corner to be snapped onto the skirting trunking base. Adjustability: ±5°. Material: ABS.					
		External corner 70x20	White RAL 9010	74/37/40	10	8698150702305	ETK70230
P127838		External corner, adjustable, DIY					
		Adjustable external corner to be snapped onto the skirting trunking base. Adjustability: ±5°. For DIY. Material: ABS.					
		External corner 70x20, DIY	White RAL 9010	74/37/40	1	3606480572067	ETK70230D
P127839		Joint cover piece					
		Joint cover piece to cover joints between skirting trunking covers. To be snapped onto the skirting trunking base. Material: ABS.					
		Joint cover piece 70x20	White RAL 9010	71/20/21	20	8698150702701	ETK70270
P127839		Joint cover piece, DIY					
		Joint cover piece to cover joints between skirting trunking covers. To be snapped onto the skirting trunking base. For DIY. Material: ABS.					
		Joint cover piece 70x20, DIY	White RAL 9010	71/20/21	2*	3606480571947	ETK70270D
P127840		Stop end					
		Stop end to be snapped onto the end of the skirting trunking base, available as left-hand and right-hand. Material: ABS.					
		Stop end 70x20, left	White RAL 9010	71/22/16	20	8698150702626	ETK70262
		Stop end 70x20, right	White RAL 9010	71/22/16	20	8698150702619	ETK70261
P127840		Stop end, DIY					
		Stop end to be snapped onto the end of the skirting trunking base, available as left-hand and right-hand. For DIY. Material: ABS.					
		Stop end 70x20, left, DIY	White RAL 9010	71/22/16	2*	3606480571886	ETK70262D
		Stop end 76x20, right, DIY	White RAL 9010	71/22/16	2*	3606480571879	ETK70261D
P127141		Universal installation box kit					
		Installation box kit including installation box, adaptor and fixing screws. Suitable for c/c 60 mm wiring devices. Material: ABS.					
		Universal installation box kit, single	White RAL 9010	40/112/86	4	8698150702800	ETK70280
P127142		Universal installation box kit, double	White RAL 9010	40/112/158.5	4	8698150702961	ETK70296

* Each Ref.No. includes 2 pieces.

Accessories skirting trunking Ultra

Type	Colour	Dimensions A/B/C (mm)		Qty per package	EAN code	Ref. No.
Installation box kit						
Installation box kit including installation box, adaptor and fixing screws. Suitable for 45x45 module wiring devices. Material: ABS.						
P126218 	White RAL 9010	52.5/112/86		4	8698150702985	ETK70298
P126219 	White RAL 9010	53.5/112/113.5		4	8698150702954	ETK70295
P126217 	White RAL 9010	53.5/112/158.5		4	8698150702978	ETK70297
Socket outlets, Ultra						
Power socket outlet for 45x45 module earthed plug, with pin or side-earth and child protection. 250V 16A. Material: PC/ABS.						
P127841 	Red White	45/41/45		10	8690495056471 3606480517709	ETK21046E ETK21046EW
P127842 	Red White	45/41/45		10	3606480517693 8690495056488	ETK21045ER ETK21045E
Socket outlet bridge						
Socket outlet bridge providing electrical connection between two socket outlets without wiring. Material: PA6 with 20% fibre glass.						
P141289 	Grey RAL 7035	7/25/70		15	8690495056464	ETK214546

Technical description

Skirting trunking

Technical and Material data

PVC	Characteristics:	Rigid, self-extinguishing, cadmium-free, lead-free
	Colour:	White RAL 9010
ABS	Characteristics:	Halogen-free
	Colours:	White RAL 9010
Degree of protection	IP40	
Temperature range	Min. storage and transportation temperature	-25°C
	Min. installation and application temperature	-5°C
	Max. application temperature	+60°C
Resistance to impact	2J (IK07)	
Delivery lengths	2 metres	
Standards and certificates	The product complies with the standards: <ul style="list-style-type: none"> • EN 50085-1:2005 • EN 50085-2-1:2006 The products also satisfy the provisions for CE marking according to the European Directive 2006/95/CE.	

Pre-punched mounting holes



Generic picture

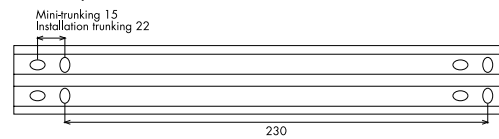

Design and dimensions

70x20

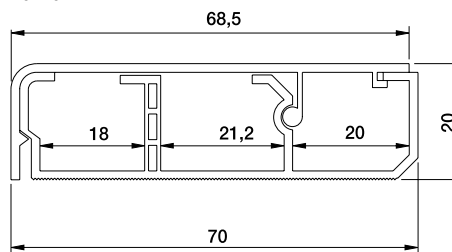



P141243

Ultra mini- and cable distribution trunking



Ultra is simple and fast to install. All accessories are designed for easy click-in mounting.

Ultra mini- and cable distribution trunking is very suitable for minor installations in both offices and homes. It is available in 19 sizes, from 12x7 to 120x60 mm. The smallest sizes are optionally available with self-adhesive tape for faster and easier installation. Corners, bends, T-pieces, etc are made of ABS. The trunking is made of self-extinguishing, cadmium and lead-free high-grade PVC, with a very good surface finish.



P126230

Adjustable corners
The corners are delivered in one piece and are adjustable to perfectly fit the building construction deviations.



P126581

Pre-punched holes
All the trunking base has pre-punched oval mounting holes every 23rd cm to make the installation fast and secure.



P127313

Reliable snap-in
The design of the profile with accurate front cover snap-in makes it easy and fast to work with. Once snapped in, the cover tightly stays in place.

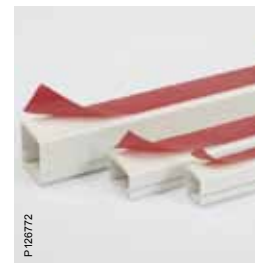

P128772

Self-adhesive tape for quicker installation
Self-adhesive tape makes installation easier and reduces installation time. Available as an option on the smallest sizes.

Choice guide

Mini-and cable distribution trunking

Ultra mini-trunking







							
Size	Ref. No	Ref. No.	Ref. No.	Ref. No.	Ref. No.	Ref. No.	Ref. No.
12x7 Self-adhesive	ETK12407						
12x12	ETK12312						
12x12 Self-adhesive	ETK12912						
16x16	ETK16316	ETK16320	ETK16330	ETK16340	ETK16350	ETK16370	ETK16361
16x16 Self-adhesive	ETK16916 ETK16416*	ETK16320D*	ETK16330D*	ETK16340D*	ETK16350D*	ETK16370D*	ETK16361D*
20x10	ETK20310						
20x10 Self-adhesive	ETK20910						
25x16	ETK25316						
25x16 Self-adhesive	ETK25916 ETK25416*	ETK25320	ETK25330	ETK25341	ETK25350	ETK25370	ETK25361
25x25	ETK25325	ETK25320D*	ETK25330D*	ETK16341D*	ETK25350D*	ETK25370D*	ETK25361D*
25x25 Self-adhesive	ETK25925 ETK25425*						
25x40	ETK25340						
30x15	ETK30315						
30x30	ETK30330						
40x16	ETK40316						
40x25	ETK40325	ETK40320	ETK40330	ETK40341	ETK40350	ETK40370	ETK40361
40x25 Self-adhesive	ETK41925	ETK40320D*	ETK40330D*	ETK40341D*	ETK40350D*	ETK40370D*	ETK40631D*
40x40	ETK40340						
40x60	ETK40360						
60x25	ETK60325						
60x40	ETK60340	ETK60320	ETK60330	ETK60341	ETK60350	ETK60370	ETK60361
60x60	ETK60360	ETK60320D*	ETK60330D*	ETK40341D*	ETK60350D*	ETK60370D*	ETK60361D*
80x60	ETK80360						
80x80	ETK80380						
120x60	ETK12360						

* DIY range

Choce guide

Mini-and cable distribution trunking

Ultra mini-trunking in plastic bag

								
Size	Length	Ref. No	Ref. No.	Ref. No.	Ref. No.	Ref. No.	Ref. No.	Ref. No.
16x16	2 m	ETK16616	ETK16320	ETK16330	ETK16340	ETK16350	ETK16370	ETK16361
	3 m	ETK16520						
16x16 Self-adhesive	2 m	ETK16716	ETK26320	ETK26330	ETK26340	ETK26350	ETK26370	ETK26361
	3 m	ETK16816						
25x16	2 m	ETK25616	ETK25320	ETK25330	ETK25341	ETK25350	ETK25370	ETK25361
	3 m	ETK25516						
25x16 Self-adhesive	2 m	ETK25716	ETK25320	ETK25330	ETK25341	ETK25350	ETK25370	ETK25361
	3 m	ETK25816						
25x25	2 m	ETK25625	ETK25320	ETK25330	ETK25341	ETK25350	ETK25370	ETK25361
	3 m	ETK25525						
25x25 Self-adhesive	2 m	ETK25725	ETK25320	ETK25330	ETK25341	ETK25350	ETK25370	ETK25361
	3 m	ETK25825						
40x25	2 m	ETK40625	ETK46320	ETK46330	ETK46341	ETK46350	ETK46370	ETK46361
	3 m	ETK40525						
40x25 Self-adhesive	2 m	ETK40925	ETK46320	ETK46330	ETK46341	ETK46350	ETK46370	ETK46361
	3 m	ETK40825						







Mini-trunking Ultra for cable distribution

Type	Colour	Dimensions A/B/C (mm)	Qty per package	EAN code	Ref. No.	
Mini-trunking						
One-compartment mini-trunking made up by a base profile with pre-punched mounting holes on every 23 rd cm and a snap-fit front cover. Suitable for power and low voltage cables. Supplied in 2 m lengths. Material: PVC.						
P141261	Mini-trunking 12x12	White RAL 9010	12/12/2000	224 m	8698150123124	ETK12312
	Mini-trunking 16x16	White RAL 9010	16/16/2000	132 m	8698150163168	ETK16316
	Mini-trunking 20x10	White RAL 9010	20/10/2000	144 m	8698150203109	ETK20310
	Mini-trunking 25x16	White RAL 9010	25/16/2000	104 m	8698150253166	ETK25316
	Mini-trunking 25x25	White RAL 9010	25/25/2000	64 m	8698150253258	ETK25325
P141265	Mini-trunking 25x40	White RAL 9010	25/40/2000	60 m	8698150253401	ETK25340
	Mini-trunking 30x15	White RAL 9010	30/15/2000	78 m	8698150303151	ETK30315
	Mini-trunking 30x30	White RAL 9010	30/30/2000	88 m	8698150303304	ETK30330
	Mini-trunking 40x16	White RAL 9010	40/16/2000	84 m	8698150403165	ETK40316
	Mini-trunking 40x25	White RAL 9010	40/25/2000	60 m	8698150403257	ETK40325
Mini-trunking in plastic bag						
One-compartment mini-trunking made up by a base profile with pre-punched mounting holes on every 23 rd cm and a snap-fit front cover. Suitable for power and low voltage cables. Supplied in 2 or 3 m lengths. Packed in a plastic bag. Material: PVC.						
P141261	Mini-trunking 16x16	White RAL 9010	16/16/2000 16/16/3000	60 m 90 m	3606480507410 3606480507427	ETK16616 ETK16520
	Mini-trunking 25x16	White RAL 9010	25/16/2000 25/16/3000	60 m 90 m	3606480507458 3606480507465	ETK25616 ETK25516
P141265	Mini-trunking 25x25	White RAL 9010	25/25/2000 25/25/3000	30 m 45 m	3606480507557 3606480507564	ETK25625 ETK25525
	Mini-trunking 40x25	White RAL 9010	40/25/2000 40/25/3000	30 m 45 m	3606480507595 3606480507601	ETK40625 ETK40525
Mini-trunking, self-adhesive						
One-compartment mini-trunking made up by a base profile with pre-punched mounting holes on every 23 rd cm and a snap-fit front cover. Supplied with self-adhesive fixing tape. Suitable for power and low voltage cables. Supplied in 2 m lengths. Material: PVC.						
P141260	Mini-trunking 12x7 self-adhesive	White RAL 9010	12/7/2000	154 m	3606480631115	ETK12407
	Mini-trunking 12x12 self-adhesive	White RAL 9010	12/12/2000	196 m	8698150129126	ETK12912
	Mini-trunking 16x16 self-adhesive	White RAL 9010	16/16/2000	156 m	8698150169160	ETK16916
P141264	Mini-trunking 20x10 self-adhesive	White RAL 9010	20/10/2000	144 m	8698150209101	ETK20910
	Mini-trunking 25x16 self-adhesive	White RAL 9010	25/16/2000	84 m	8698150259168	ETK25916
	Mini-trunking 25x25 self-adhesive	White RAL 9010	25/25/2000	64 m	8698150259250	ETK25925
	Mini-trunking 40x25 self-adhesive	White RAL 9010	40/25/2000	60 m	8690495072396	ETK41925
Mini-trunking, self-adhesive, with label, for DIY						
One-compartment mini-trunking with label, made up by a base profile with pre-punched mounting holes on every 23 rd cm and a snap-fit front cover. Supplied with self-adhesive fixing tape. Suitable for power and low voltage cables. Supplied in 2 m lengths. Material: PVC.						
P141260	Mini-trunking 12x12 self-adhesive, DIY	White RAL 9010	12/12/2000	88 m	3606480660023	ETK12812
	Mini-trunking 16x16 self-adhesive, DIY	White RAL 9010	16/16/2000	156 m	3606480572586	ETK16416
P141264	Mini-trunking 25x16 self-adhesive, DIY	White RAL 9010	25/16/2000	84 m	3606480572593	ETK25416
	Mini-trunking 25x25 self-adhesive, DIY	White RAL 9010	25/25/2000	64 m	3606480572609	ETK25425

Range

Mini-and cable distribution trunking

Mini-trunking Ultra for cable distribution

Type	Colour	Dimensions A/B/C (mm)		Qty per package	EAN code	Ref. No.	
Mini-trunking in plastic bag, self-adhesive							
One-compartment mini-trunking made up by a base profile with pre-punched mounting holes on every 23 rd cm and a snap-fit front cover. Supplied with self-adhesive fixing tape. Suitable for power and low voltage cables. Supplied in 2 or 3 m lengths. Packed in a plastic bag. Material: PVC.							
P141260		Mini-trunking 16x16 self-adhesive	White RAL 9010	16/16/2000	60 m	3606480507434	ETK16716
				16/16/3000	90 m	3606480507441	ETK16816
P141264		Mini-trunking 25x16 self-adhesive	White RAL 9010	25/16/2000	60 m	3606480507472	ETK25716
				25/16/3000	90 m	3606480507489	ETK25816
P141264		Mini-trunking 25x25 self-adhesive	White RAL 9010	25/25/2000	30 m	3606480507571	ETK25725
				25/25/3000	45 m	3606480507588	ETK25825
P141264		Mini-trunking 40x25 self-adhesive	White RAL 9010	40/25/2000	30 m	3606480507618	ETK40925
				40/25/3000	45 m	3606480507625	ETK40825
Distribution trunking							
One-compartment distribution trunking made up by a base profile with pre-punched mounting holes on every 23 rd cm and a snap-fit front cover. Suitable for power and low voltage cables. Supplied in 2 m lengths. Material: PVC.							
P141269		Distr. trunking 40x40	White RAL 9010	40/40/2000	36 m	8698150403400	ETK40340
		Distr. trunking 40x60	White RAL 9010	40/60/2000	24 m	8698150403608	ETK40360
		Distr. trunking 60x25	White RAL 9010	60/25/2000	36 m	8698150603251	ETK60325
P141271		Distr. trunking 60x40	White RAL 9010	60/40/2000	24 m	8698150603404	ETK60340
		Distr. trunking 60x60	White RAL 9010	60/60/2000	16 m	8698150603602	ETK60360
		Distr. trunking 80x60	White RAL 9010	80/60/2000	16 m	8698150803606	ETK80360
		Distr. trunking 80x80	White RAL 9010	80/80/2000	16 m	8698150803804	ETK80380
		Distr. trunking 120x60	White RAL 9010	120/60/2000	16 m	8698150123605	ETK12360

Accessories Mini-trunking Ultra for cable distribution

Type	Colour	Dimensions A/B/C (mm)		Qty per package	EAN code	Ref. No.
Internal corner, adjustable						
Internal corner to be snapped onto the mini-trunking base. Adjustability: $\pm 5^\circ$. Material: ABS.						
Int. corner 16x16, adj.	White RAL 9010	16/32/35		60	8698150163205	ETK16320
Int. corner 25x16, 25x25, adj.	White RAL 9010	29/45/45		40	8698150253203	ETK25320
Internal corner dedicated to 25x16, adjustable	White RAL 9010	29/45/45		40	3606480507496	ETK26320
Int. corner 40x16, 40x25, 40x40, adj.	White RAL 9010	43/62/62		36	8698150403202	ETK40320
Internal corner dedicated to 40x25, adjustable	White RAL 9010	43/62/62		40	3606480507632	ETK46320
Int. corner 60x25, 60x40, 60x60, adj.	White RAL 9010	86/71/89		14	8698150603206	ETK60320
Internal corner, adjustable, DIY						
Internal corner to be snapped onto the mini-trunking base. Adjustability: $\pm 5^\circ$. For DIY. Material: ABS.						
Int. corner 16x16, adj., DIY	White RAL 9010	16/32/35		1	3606480572043	ETK16320D
Int. corner 25x16, 25x25, adj., DIY	White RAL 9010	29/45/45		1	3606480572036	ETK25320D
Int. corner 40x16, 40x25, 40x40, adj., DIY	White RAL 9010	43/62/62		2*	3606480572029	ETK40320D
Int. corner 60x25, 60x40, 60x60, adj., DIY	White RAL 9010	86/71/89		2*	3606480572012	ETK60320D
External corner, adjustable						
External corner to be snapped onto the mini-trunking base. Adjustability: $\pm 5^\circ$. Material: ABS.						
Ext. corner 16x16, adj.	White RAL 9010	16/32/35		60	8698150163304	ETK16330
Ext. corner 25x16, 25x25, adj.	White RAL 9010	28/45/45		40	8698150253302	ETK25330
External corner dedicated to 25x16, adjustable	White RAL 9010	28/45/45		40	3606480507502	ETK26330
Ext. corner 40x16, 40x25, 40x40, adj.	White RAL 9010	43/62/62		36	8698150403301	ETK40330
External corner dedicated to 40x25, adjustable	White RAL 9010	43/62/62		40	3606480507649	ETK46330
Ext. corner 60x25, 60x40, 60x60, adj.	White RAL 9010	84/85/85		12	8698150603305	ETK60330
External corner, adjustable, DIY						
External corner to be snapped onto the mini-trunking base. Adjustability: $\pm 5^\circ$. For DIY. Material: ABS.						
Ext. corner 16x16, adj., DIY	White RAL 9010	16/32/35		2*	3606480572104	ETK16330D
Ext. corner 25x16, 25x25, adj., DIY	White RAL 9010	28/45/45		2*	3606480572098	ETK25330D
Ext. corner 40x16, 40x25, 40x40, adj., DIY	White RAL 9010	43/62/62		2*	3606480572081	ETK40330D
Ext. corner 60x25, 60x40, 60x60, adj., DIY	White RAL 9010	84/85/85		2*	3606480572074	ETK60330D
Bend, 90°						
90 degree bend to be used in junctions between horizontal and vertical applications. To be snapped onto the mini-trunking base. Material: ABS.						
Bend 90° 16x16	White RAL 9010	15/31/31		60	8698150163403	ETK16340
Bend 90° 25x16, 25x25	White RAL 9010	27/45/45		40	8698150253418	ETK25341
Bend 90° dedicated to 25x16	White RAL 9010	27/45/45		50	3606480507519	ETK26340
Bend 90° 40x16, 40x25, 40x40	White RAL 9010	41/60/60		40	8698150403417	ETK40341
Bend 90° dedicated to 40x25	White RAL 9010	41/60/60		40	3606480507656	ETK46341
Bend 90° 60x25, 60x40, 60x60	White RAL 9010	62/85.5/85.5		18	8698150603411	ETK60341

* Each Ref.No. includes 2 pieces.

Accessories Mini-trunking Ultra for cable distribution

Type	Colour	Dimensions A/B/C (mm)	Qty per package	EAN code	Ref. No.
Bend, 90°, DIY					
90 degree bend to be used in junctions between horizontal and vertical applications. To be snapped onto the mini-trunking base. For DIY. Material: ABS.					
Bend 90° 16x16, DIY	White RAL 9010	15/31/31	2*	3606480572159	ETK16340D
Bend 90° 25x16, 25x25, DIY	White RAL 9010	27/45/45	2*	3606480572142	ETK25341D
Bend 90° 40x16, 40x25, 40x40, DIY	White RAL 9010	41/60/60	2*	3606480572135	ETK40341D
Bend 90° 60x25, 60x40, 60x60, DIY	White RAL 9010	62/85.5/85.5	2*	3606480572128	ETK60341D
T-piece					
T-piece to be used in T-junctions between mini-trunking of the same size. To be snapped onto the mini-trunking base. Material: ABS.					
T-Piece 16x16	White RAL 9010	15/31/42	60	8698150163502	ETK16350
T-Piece 25x16, 25x25	White RAL 9010	27/45/65	40	8698150253500	ETK25350
T-Piece dedicated to 25x16	White RAL 9010	27/45/65	50	3606480507526	ETK26350
T-Piece 40x16, 40x25, 40x40	White RAL 9010	41/60/77	40	8698150403509	ETK40350
T-Piece dedicated to 40x25	White RAL 9010	41/60/77	50	3606480507663	ETK46350
T-Piece 60x25, 60x40, 60x60	White RAL 9010	62/86/105	6	8698150603503	ETK60350
T-piece, DIY					
T-piece to be used in T-junctions between mini-trunking of the same size. To be snapped onto the mini-trunking base. For DIY. Material: ABS.					
T-Piece 16x16, DIY	White RAL 9010	15/31/42	1	3606480571855	ETK16350D
T-Piece 25x16, 25x25, DIY	White RAL 9010	27/45/65	1	3606480571848	ETK25350D
T-Piece 40x16, 40x25, 40x40, DIY	White RAL 9010	41/60/77	1	3606480571831	ETK40350D
T-Piece 60x25, 60x40, 60x60, DIY	White RAL 9010	62/86/105	1	3606480571824	ETK60350D
Joint cover piece					
Joint cover piece to cover joints between mini-trunking covers. To be snapped onto the mini-trunking base. Material: ABS.					
Joint cover piece 16x16	White RAL 9010	18/19/15	50	8698150163700	ETK16370
Joint cover piece 25x16, 25x25	White RAL 9010	26.5/28/16	50	8698150253708	ETK25370
Joint cover piece dedicated to 25x16	White RAL 9010	26.5/28/16	60	3606480507540	ETK26370
Joint cover piece 40x16, 40x25, 40x40	White RAL 9010	40.5/43/20	60	8698150403707	ETK40370
Joint cover piece dedicated to 40x25	White RAL 9010	40.5/43/20	60	3606480507687	ETK46370
Joint cover piece 60x25, 60x40, 60x60	White RAL 9010	63/65/10	25	8698150603701	ETK60370
Joint cover piece, DIY					
Joint cover piece to cover joints between mini-trunking covers. To be snapped onto the mini-trunking base. For DIY. Material: ABS.					
Joint cover piece 16x16, DIY	White RAL 9010	18/19/15	2*	3606480571985	ETK16370D
Joint cover piece 25x16, 25x25, DIY	White RAL 9010	26.5/28/16	2*	3606480571978	ETK25370D
Joint cover piece 40x16, 40x25, 40x40, DIY	White RAL 9010	40.5/43/20	2*	3606480571961	ETK40370D
Joint cover piece 60x25, 60x40, 60x60, DIY	White RAL 9010	63/65/10	2*	3606480571954	ETK60370D
Stop end					
Stop end to be snapped onto the end of the mini-trunking base. Material: ABS.					
Stop end 16x16	White RAL 9010	18/18/5	60	8698150163618	ETK16361
Stop end 25x16, 25x25	White RAL 9010	27/27/7	60	8698150253616	ETK25361
Stop end dedicated to 25x16	White RAL 9010	27/27/7	40	3606480507533	ETK26361
Stop end 40x16, 40x25, 40x40	White RAL 9010	62/43/10	50	8698150403615	ETK40361
Stop end dedicated to 40x25	White RAL 9010	62/43/10	40	3606480507670	ETK46361
Stop end 60x25, 60x40, 60x60	White RAL 9010	63/65/10	50	8698150603619	ETK60361

* Each Ref.No. includes 2 pieces.

Accessories Mini-trunking Ultra for cable distribution

Type	Colour	Dimensions A/B/C (mm)	Qty per package	EAN code	Ref. No.
Stop end, DIY					
Stop end to be snapped onto the end of the mini-trunking base. For DIY. Material: ABS.					
Stop end 16x16, DIY	White RAL 9010	18/18/5	2*	3606480571923	ETK16361D
Stop end 25x16, 25x25, DIY	White RAL 9010	27/27/7	2*	3606480571916	ETK25361D
Stop end 40x16, 40x25, 40x40, DIY	White RAL 9010	62/43/10	2*	3606480571909	ETK40361D
Stop end 60x25, 60x40, 60x60, DIY	White RAL 9010	63/65/10	2*	3606480571893	ETK60361D

* Each Ref.No. includes 2 pieces.

Technical and Material data

PVC	Characteristics:	Rigid, self-extinguishing, cadmium-free, lead-free
	Colour:	White RAL 9010
ABS	Characteristics:	Halogen-free
	Colours:	White RAL 9010
Degree of protection	IP40	
Temperature range	Min. storage and transportation temperature	-25°C
	Min. installation and application temperature	-5°C
	Max. application temperature	+60°C
Resistance to impact	2J (IK07)	
Delivery lengths	2 metres	
Standards and certificates	The product complies with the standards: • EN 50085-1:2005 • EN 50085-2-1:2006	
	The products also satisfy the provisions for CE marking according to the European Directive 2006/95/CE.	

Pre-punched mounting holes



Generic picture

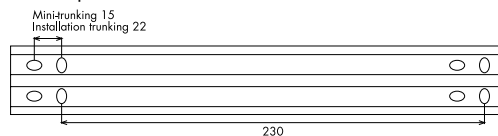

P126211



Design and dimensions

12x7

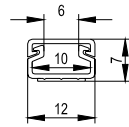

12x12

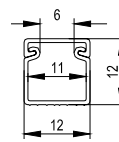

16x16

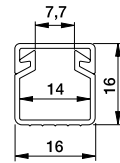

20x10

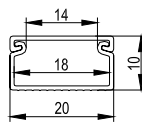

25x16

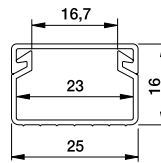

25x25

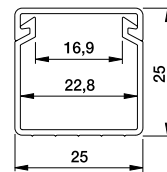

25x40

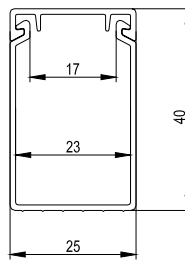

30x15

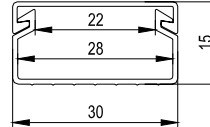

30x30

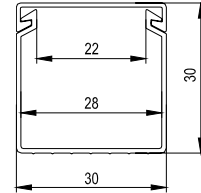

40x16

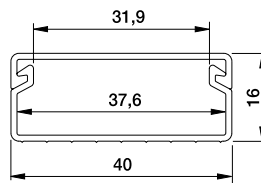

40x25

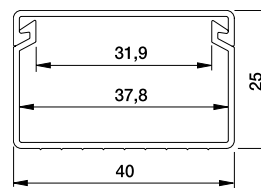

40x40

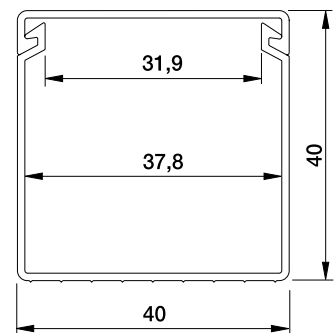

40x60

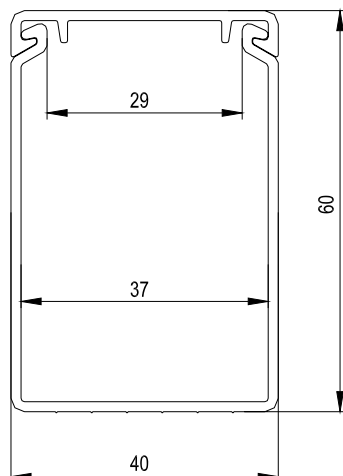

60x25

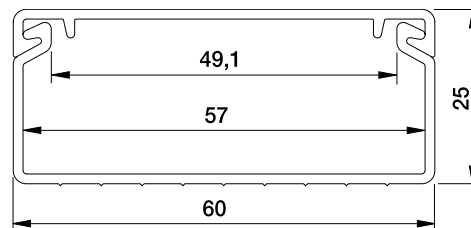

Design and dimensions

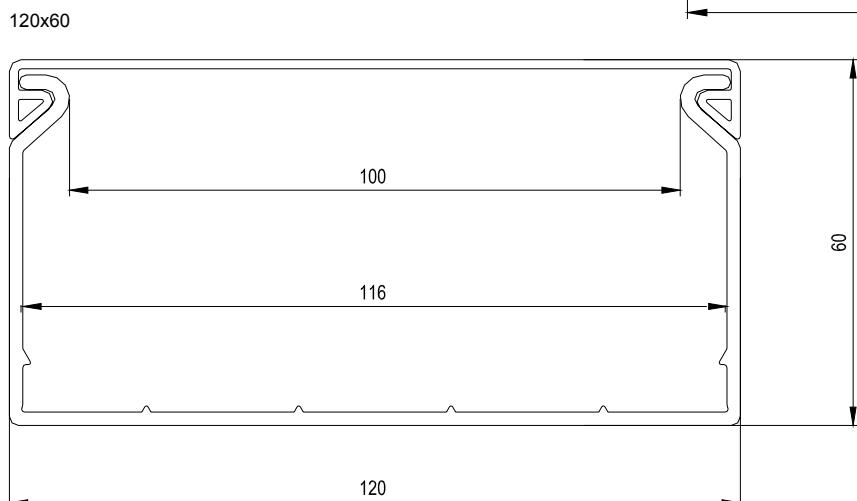
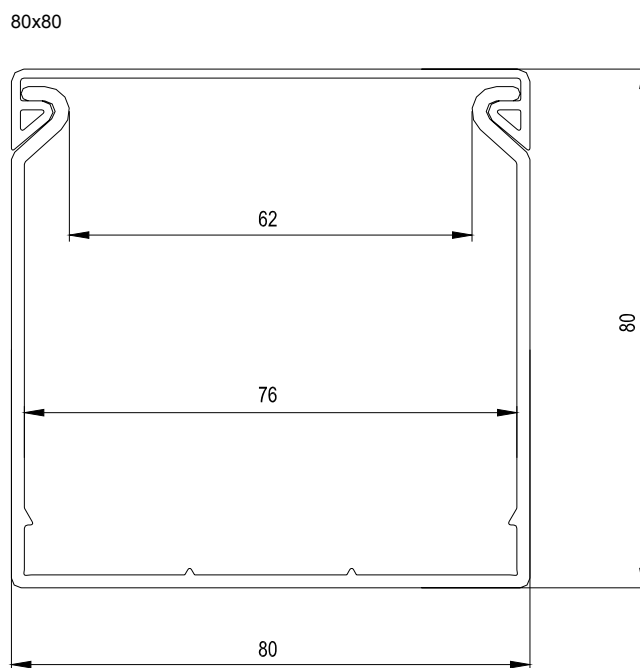
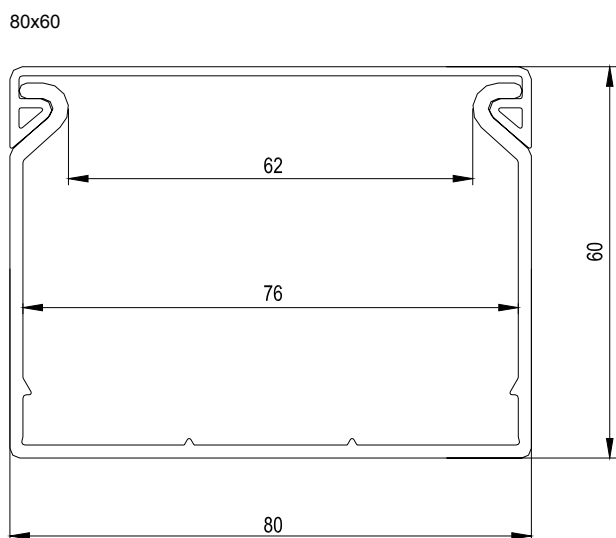
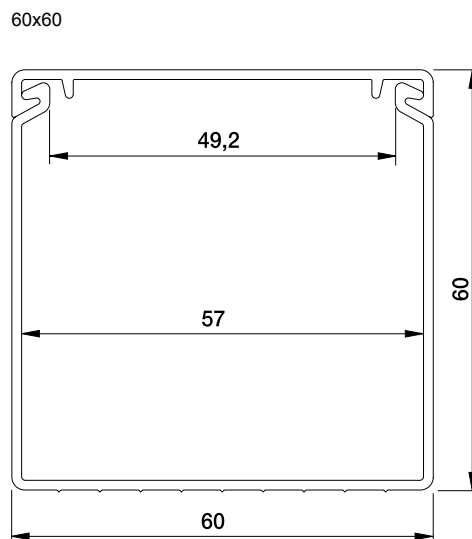
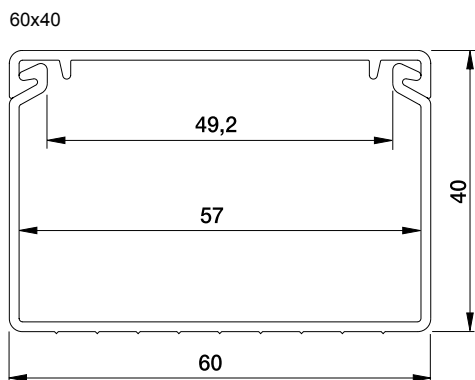



Ultra on-floor trunking

For organizing and hiding cables

Ultra on-floor trunking is a floor trunking for data, power and telephone cables. Chamber partitioning ensures that the entire floor trunking is tamper-proof with high protection of cables. It is made up by a base part with three or four compartments and a cover. Supplied in lengths of 2 metres. All parts are made of rigid, self-extinguishing, cadmium and lead-free high-grade PVC. All products are RoHS compliant.



Ultra complies with the standards EN 50085-1 and EN 50085-2-1. The products also satisfy the provisions for CE marking according to the European Directive 2006/95/CE.



Organize the cables in a neat and safe way

The three or four compartment trunking base has pre-punched oval mounting holes every 23 cm for fast and secure mounting on the floor. If the floor trunking is to be laid on a carpeted floor, the fluted underside provides a certain degree of resistance to slipping out of position.

On-floor trunking Ultra

PH41273



Type	Colour	Dimensions A/B/C (mm)	Qty per package	EAN code	Ref. No.
On-floor trunking					
On-floor trunking made up by a base part with three (50x12) or four (77x19) compartments and a cover. To be used for feeding along the floor. Supplied in lengths of 2 m. Material: ABS.					
On-floor trunking 50x12	Grey RAL 7023	12/50/2000	80	8698150500123	ETK50012
On-floor trunking 77x19	Grey RAL 7023	19/77/2000	40	8698150770199	ETK77019

Technical and Material data

ABS	Characteristics:	Halogen-free
	Colours:	Grey RAL 7023
Degree of protection	IP40	
Temperature range	-15 - +60°C	
Resistance to impact	2J (IK07)	
Delivery lengths	2 metres	
Standards and certificates	The product complies with the standards: • EN 50085-1:2005 • EN 50085-2-1:2006 The products also satisfy the provisions for CE marking according to the European Directive 2006/95/CE.	

Maximum pressure

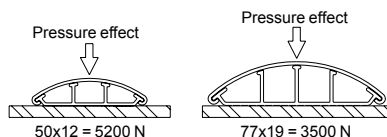

Design and dimensions

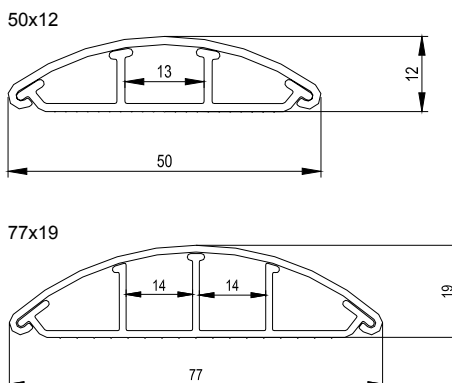



Ultra floor boxes

Floor boxes for 45x45 module wiring device

Supplying power, data and telephone to a workplace through the floor offers many advantages. For industrial and commercial buildings. To be used in raised access floors, screeded floors or in cavity floors. Used for instance in environments where it is important to have an installation that is discrete and “invisible” when not used. Ultra floor boxes give you access to power and data wherever it is required. The Ultra floor box system consists of 2, 4 and 6 module floor outlet boxes for Altira, Unica or Ultra direct click-in wiring device, floor access boxes, screeded floor boxes and a number of accessories. All products are made of halogen-free material.



Ultra complies with the standards IEC 60670-1 and IEC 60670-23. The products also satisfy the provisions for CE marking according to the European Directive 2006/95/CE.



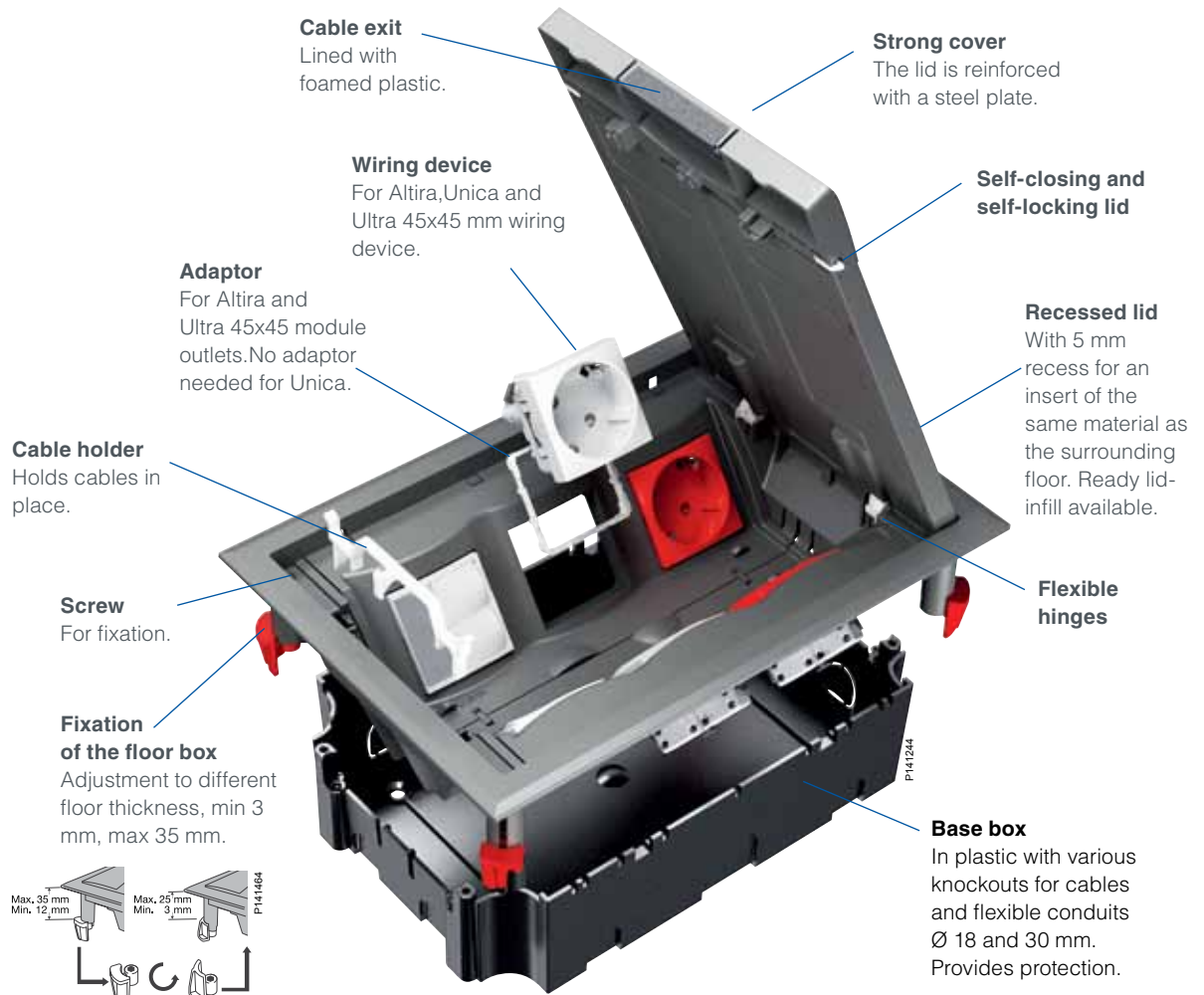

High safety
The lid closes automatically by its own weight
– Increased safety
– Reduces accident risk.



Flexible hinges
The hinges have a spring that stops the lid at 90° from being bent backwards. Allows the lid to be turned 180°.



Self-locking lid
The lid is self-locking to minimize the risk of accidents.



Cable holder
Holds cables in place and prevents them from being pulled out or damaged between the lid and the trim frame.



Cable exit
The cable exits are lined with foamed plastic, preventing dirt from penetrating into the box.











Blends with the floor
The lid has a recess of 5 mm for an insert of the same material as the surrounding floor.





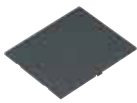
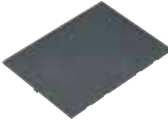



2 module floor box with 4 cable outlets
This is a very small and neat floor box, perfect when you only need a couple of outlets or a power and a data outlet. The lid has four cable exits which make it flexible.

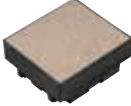

Floor outlet boxes Ultra

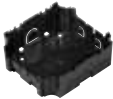
Type	Colour	Dimensions A/B/C (mm)		Qty per package	EAN code	Ref. No.
Floor box, 2 module						
Complete 2 module floor box, including two mounting frames for Unica wiring devices, two adaptors for Altira/Ultra wiring devices (to be snap-fitted in the mounting frame), two swivel fixings allowing for floor thicknesses from 3 to 35 mm, lid with locking device and a safety string preventing the lid from being lost, and four cable exits (including dust protection). Easy opening and closing of the lid. The mounting frames are snap-fitted into the box. The floor box is suitable for 45x45 mm or 22.5x45 mm outlets. Material: PA6, reinforced.						
 P141300	Floor box, 2 module	Grey RAL 7011	82/100/160	2	3606480669057	ETK44104
Floor box, 4 module						
Complete 4 module floor box, including two mounting frames for Unica wiring devices, four adaptors for Altira/Ultra wiring devices (to be snap-fitted in the mounting frame), four swivel fixings allowing for floor thicknesses from 3 to 35 mm, cable holder, lid with locking device and a cable exit (including dust protection). Easy opening and closing of the lid. The hinged lid can be turned 180 degrees and is easily removed. The lid is reinforced with a steel plate. It can be fitted with an insert of floor material up to 5 mm thickness. Ready lid-infill available as accessory. The mounting frames are snap-fitted into the box. The floor box is suitable for 45x45 mm or 22.5x45 mm outlets. Material: PA6, reinforced.						
 P141301	Floor box, 4 module	Grey RAL 7011	82/187/206	1	3606480669064	ETK44108
Floor box, 6 module						
Complete 6 module floor box, including two mounting frames for Unica wiring devices, six adaptors for Altira/Ultra wiring devices (to be snap-fitted in the mounting frame), four swivel fixings allowing for floor thicknesses from 3 to 35 mm, cable holder, lid with locking device and a cable exit (including dust protection). Easy opening and closing of the lid. The hinged lid can be turned 180 degrees and is easily removed. The lid is reinforced with a steel plate. It can be fitted with an insert of floor material up to 5 mm thickness. Ready lid-infill available as accessory. The mounting frames are snap-fitted into the box. The floor box is suitable for 45x45 mm or 22.5x45 mm outlets. Material: PA6, reinforced.						
 P141302	Floor box, 6 module	Grey RAL 7011	82/187/270	1	3606480669071	ETK44112
Lid infill						
Lid infill, 4 or 6 module, to be used in the lid of floor boxes. Provided with a snap-in function. Material: PA6, reinforced.						
 P141303	Lid infill, for 4 mod. box	Grey RAL 7011	4/148/126	1	3606480669088	ETK44108T
 P141304	Lid infill, for 6 mod. box	Grey RAL 7011	4/148/195	1	3606480669095	ETK44112T
Floor access box						
The floor access box provides inspection possibility of the underfloor installation. The floor access box includes four swivel fixings allowing for floor thicknesses from 3 to 35 mm, lid with locking device and a cable exit (including dust protection). Easy opening and closing of the lid. The hinged lid can be turned 180 degrees and easily removed. The lid is reinforced with a steel plate. It can be fitted with an insert of floor material up to 5 mm thickness. Ready lid-infill available as accessory. Material: PA6, reinforced.						
 P141305	Floor access box, square	Grey RAL 7011	82/187/206	1	3606480669101	ETK44508
 P141306	Floor access box, rectangular	Grey RAL 7011	82/187/270	1	3606480669118	ETK44512
Screeded floor box						
Screeded floor box, 2 module, for embedment in screeded floors from 75 to 95 mm thickness. With four knock-outs Ø24 mm. Including screws for height adjustment and nivelling. Including lid. Material: PC+ABS.						
 P141311	Screeded box, 2 module	Black RAL 9004	80/130/170	2	3606480669163	ETK44832

Floor outlet boxes Ultra

Type	Colour	Dimensions A/B/C (mm)	Qty per package	EAN code	Ref. No.		
Screeded floor box							
Screeded floor box, 4 module, for embedment in screeded floors from 75 to 95 mm thickness. With four knock-outs Ø18 mm and two knock-outs Ø30 mm. Including screws for height adjustment and nivelling. Including cover. Material: PC+ABS.							
P141312		Screeded box, 4 module	Black RAL 9004	90/170/189	3	3606480669170	ETK44834
Screeded floor box, 6 module, for embedment in screeded floors from 75 to 95 mm thickness. With eight knock-outs Ø18 mm and two knock-outs Ø30 mm. Including screws for height adjustment and nivelling. Including cover. Material: PC+ABS.							
P141313		Screeded box, 6 module	Black RAL 9004	90/170/255	2	3606480669187	ETK44836
Base box							
Base box, 4 module. For protection of devices installed in the floor box. With four knock-outs Ø18 mm and two knock-outs Ø30 mm. Material: PA6, reinforced.							
P141308		Base box, 4 module	Grey RAL 7011	65/165/175	6	3606480669132	ETK44708
Base box, 6 module. For protection of devices installed in the floor box. With eight knock-outs Ø18 mm and two knock-outs Ø30 mm. Material: PA6, reinforced.							
P141309		Base box, 6 module	Grey RAL 7011	65/165/240	4	3606480669149	ETK44712
Cable holder							
Cable holder for cable exit. To be used as spare part. Material: PC+ABS.							
P141310		Cable holder	White RAL 9003	15/95/30	5	3606480669156	ETK44830
Adaptor Altira/Ultra							
Adaptor for 45x45 mm Altira/Ultra outlets. To be used as spare part. Note that the responsibility for this reference lies within the WDE team. For further information, please contact them. Material: PC+ABS.							
P141314		Adaptor	White	6/45/46	10	8420375087642	U0.582

Technical description

Floor outlet box



Technical and Material data

PA 6	Characteristics:	Reinforced with 10% glass-fibre Halogen-free
	Colour:	Grey RAL 7011
PC+ABS	Characteristics:	Halogen-free
	Colours:	• Black RAL 9004 • White RAL 9003
Degree of protection	IP20	
Resistance to glow wire tests	650°C and 850°C	
Temperature range	Min. storage and transportation temperature	-25°C
	Min. installation and application temperature	-5°C
	Max. application temperature	+60°C
Standards and certificates	The product complies with the standards: • UNE 20451 • CEI 60670-1 (Draft IEC 60670-23)	
	The products also satisfy the provisions for CE marking according to the European Directive 2006/95/CE.	



Floor thickness

Quick installations in floor thicknesses from 3 to 35 mm.

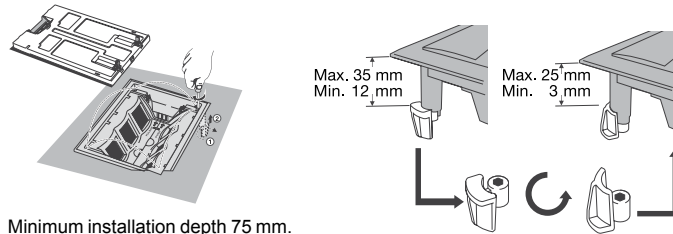

45x45 devices have a correct position in the floor boxes.

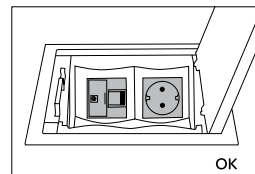
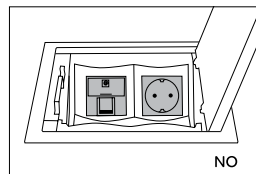

Technical description

Floor outlet box

Floor box

Size of the hole in the floor (mm):

Ref.	Ø	A	B
ETK44104	80 x 2		
ETK44108		164	182
ETK44112		164	246

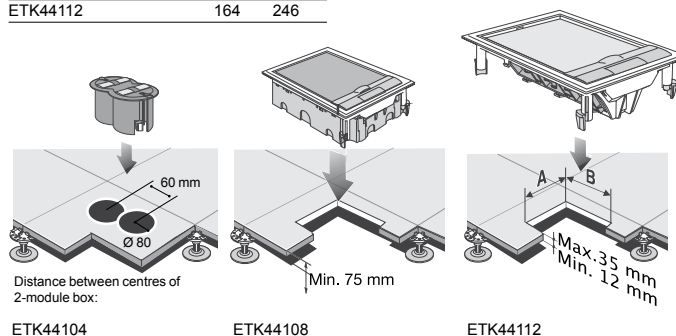

ETK44104

ETK44108

ETK44112

Lid infill

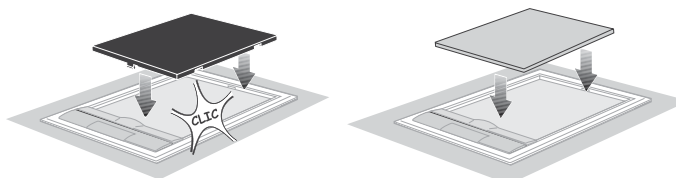

Accessory

Optional (DIY)

Screeded floor box

The screeded floor boxes are used for protection of floor boxes embedded in concrete, making them able to withstand the whole load of the concrete around them.

2-module:

It is provided with knock-outs on the sides, 4xØ24.

4-module:

It is provided with knock-outs on the sides, 4xØ18 and 2xØ30.

6-module:

It is provided with knock-outs on the sides, 8xØ18 and 2xØ30.

Screws at the four corners allow leveling of the box between 75 and 90 mm.

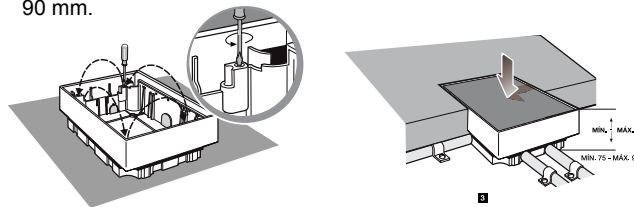

Base box

Optionally, the mechanisms of floor boxes can be protected by base boxes:

The base box is fixed by pressure to the floor box without tools.

The 4-module base box is for 4 tubes Ø18 and 2 tubes Ø30 on the sides.

The 6-module base box is for 8 tubes Ø18 and 2 tubes Ø30 on the sides.

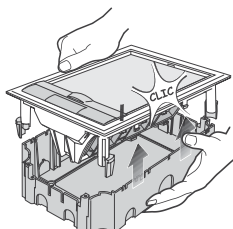

Technical description

Floor outlet box

External dimensions

2-module floor box

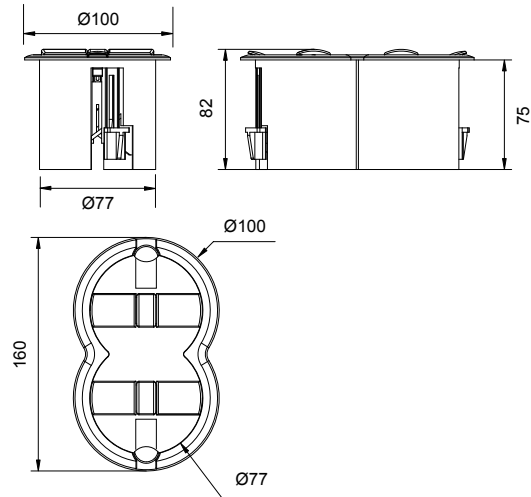

External dimensions

2-module screeded floor box

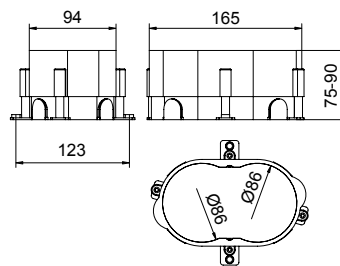

4-module and 6-module floor box

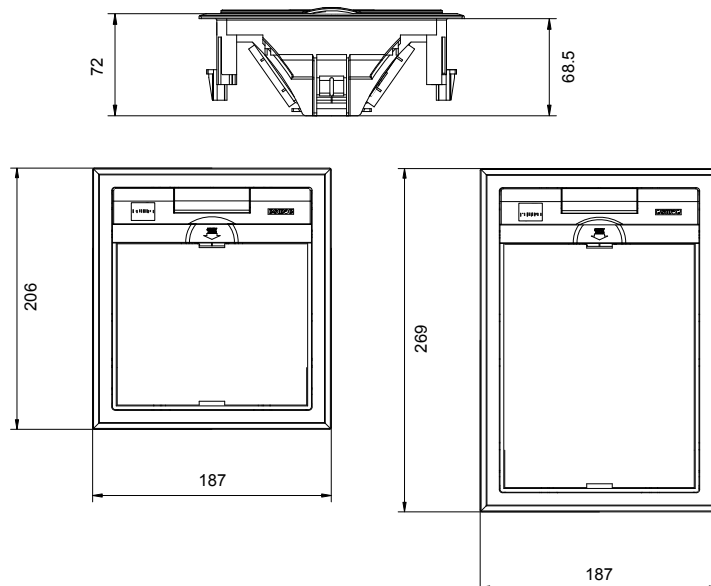

Technical description

Floor outlet box

4-module screeded floor box

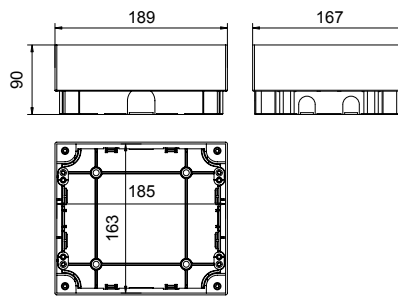

6-module screeded floor box

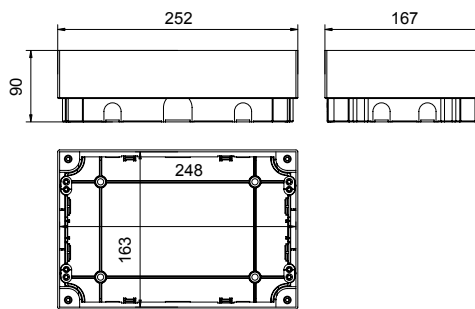

4-module and 6-module base box

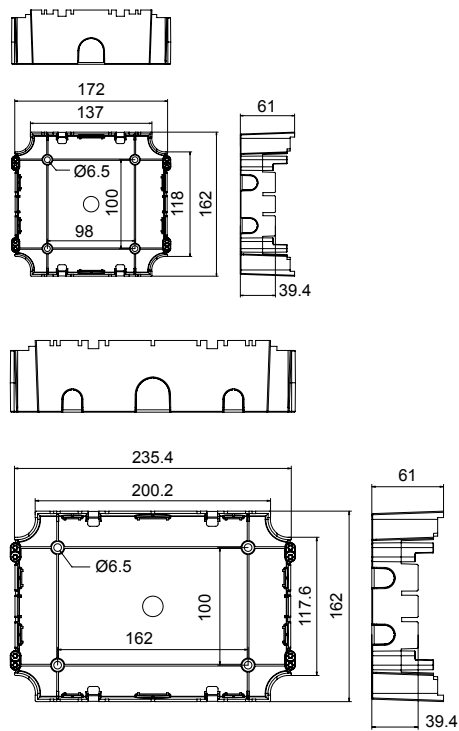

* Make the most of your energy

Schneider Electric Industries SAS
35 rue Joseph Monier
92500 Rueil-Malmaison
France
www.schneider-electric.com

As standards, specifications and designs change from time to time, please ask for confirmation of the information given in this publication.



This document has been printed
on ecological paper

Publishing: Schneider Electric Industries SAS
Design:
Illustrations:
Photos:
Printing: