

INSTALLATION MANUAL

Wall-mounted Type

Digital Scroll and DC/AC Inverter Commercial Air-conditioner

The Digital Scroll and DC/AC Inverter share the same indoor units.

Thank you very much for purchasing our air conditioner,
please read this manual carefully and keep it for future reference.

CONTENTS

PAGE

PRECAUTIONS.....	1
INSTALLATION INFORMATION.....	2
ATTACHED FITTINGS.....	3
INSPECTING AND HANDLING THE UNIT.....	4
INDOOR UNIT INSTALLATION.....	4
REFRIGERANT PIPE INSTALLATION.....	6
WIRING CHART.....	7
TEST OPERATION.....	10

1. PRECAUTIONS

- Be sure to be in conformity with the local, national and international laws and regulations.
- Read "PRECAUTIONS" carefully before installation.
- The following precautions include important safety items. Observe them and never forget.
- Keep this manual with the owner's manual in a handy place for future reference.
- Installation must be performed in accordance with the requirement of NEC and CEC by authorized personnel only.

The safety precautions listed here are divided into two categories. In either case, important safety information is listed which must be read carefully.

 **WARNING**
 Failure to observe a warning may result in death.

 **CAUTION**
 Failure to observe a caution may result in injury or damage to the equipment.

After completing the installation, make sure that the unit operates properly during the start-up operation. Please instruct the customer on how to operate the unit and keep it maintained. Also, inform customers that they should store this installation manual along with the owner's manual for future reference.

 **WARNING**

Be sure only trained and qualified service personnel to install, repair or service the equipment.
 Improper installation, repair, and maintenance may result in electric shocks, short-circuit, leaks, fire or other damage to the equipment.

Install according to this installation instructions strictly.
 If installation is defective, it will cause water leakage, electric shocks, fire.

When installing the unit in a small room, take measures against to keep refrigerant concentration from exceeding allowable safety limits in the event of refrigerant leakage. Contact the place of purchase for more information. Excessive refrigerant in a closed ambient can lead to oxygen deficiency.

Use the attached accessories parts and specified parts for installation.
 otherwise, it will cause the set to fall, water leakage, electrical shock fire.

Install at a strong and firm location which is able to withstand the set's weight.
 If the strength is not enough or installation is not properly done, the set will drop to cause injury.

The appliance must be installed 2.5m above floor.

The appliance shall not be installed in the laundry.

Before obtaining access to terminals, all supply circuits must be disconnected.

The appliance must be positioned so that the plug is accessible.

The enclosure of the appliance shall be marked by word, or by symbols, with the direction of the fluid flow.

For electrical work, follow the local national wiring standard, regulation and this installation instructions. An independent circuit and single outlet must be used.
 If electrical circuit capacity is not enough or defect in electrical work, it will cause electrical shock fire.

Use the specified cable and connect tightly and clamp the cable so that no external force will be acted on the terminal.
 If connection or fixing is not perfect, it will cause heat-up or fire at the connection.

Wiring routing must be properly arranged so that control board cover is fixed properly.
 If control board cover is not fixed perfectly, it will cause heat-up at connection point of terminal, fire or electrical shock.

If the supply cord is damaged, it must be replaced by the manufacture or its service agent or similarly qualified person in order to avoid a hazard.

An all-pole disconnection switch having a contact separation of at least 3mm in a poles should be connected in fixed wiring.

When carrying out piping connection, take care not to let air substances go into refrigeration cycle.
 Otherwise, it will cause lower capacity, abnormal high pressure in the refrigeration cycle, explosion and injury.

Do not modify the length of the power supply cord or use of extension cord, and do not share the single outlet with other electrical appliances.
 Otherwise, it will cause fire or electrical shock.

Carry out the specified installation work after taking into account strong winds, typhoons or earthquakes.
 Improper installation work may result in the equipment falling and causing accidents.

If the refrigerant leaks during installation, ventilate the area immediately.

Toxic gas may be produced if the refrigerant comes into the place contacting with fire.

After completing the installation work, check that the refrigerant does not leak.

Toxic gas may be produced if the refrigerant leaks into the room and comes into contact with a source of fire, such as a fan heater, stove or cooker.



CAUTION

Ground the air conditioner.

Do not connect the ground wire to gas or water pipes, lightning rod or a telephone ground wire. Incomplete grounding may result in electric shocks.

Be sure to install an earth leakage breaker.

Failure to install an earth leakage breaker may result in electric shocks.

Connect the outdoor unit wires, then connect the indoor unit wires.

You are not allowed to connect the air conditioner with the power source until wiring and piping the air conditioner is done.

While following the instructions in this installation manual, install drain piping in order to ensure proper drainage and insulate piping in order to prevent condensation.

Improper drain piping may result in water leakage and property damage.

Install the indoor and outdoor units, power supply wiring and connecting wires at least 1 meter away from televisions or radios in order to prevent image interference or noise.

Depending on the radio waves, a distance of 1 meter may not be sufficient enough to eliminate the noise.

The appliance is not intended for use by young children or infirm persons without supervision.

Young children should be supervised to ensure that they do not play with the appliance.

Don't install the air conditioner in the following locations:

- There is petrolatum existing.
 - There is salty air surrounding (near the coast).
 - There is caustic gas (the sulfide, for example) existing in the air (near a hot spring).
 - The Volt vibrates violently (in the factories).
 - In buses or cabinets.
 - In kitchen where it is full of oil gas.
 - There is strong electromagnetic wave existing.
 - There are inflammable materials or gas.
 - There is acid or alkaline liquid evaporating.
 - The appliance shall not be installed in the laundry.
 - Other special conditions.
-

2. INSTALLATION INFORMATION



















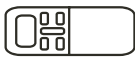

- To install properly, please read this "installation manual" at first.
 - The air conditioner must be installed by qualified persons.
 - When installing the indoor unit or its tubing, please follow this manual as strictly as possible.
 - If the air conditioner is installed on a metal part of the building, it must be electrically insulated according to the relevant standards to electrical appliances.
 - When all the installation work is finished, please turn on the power only after a thorough check.
 - Regret for no further announcement if there is any change of this manual caused by product improvement.
-

INSTALLATION ORDER

- Select the location;
- Install the indoor unit;
- Install the outdoor unit;
- Install the connecting pipe ;
- Connect the drain pipe;
- Wiring;
- Test operation.

3. ATTACHED FITTINGS

Please check whether the following fittings are of full scope. If there are some spare fittings, please restore them carefully.

NAME	SHAPE	QUANTITY	FUNCTION
1. Remote controller manual		1	
2. Screw ST3.9x25 for installation board		8	Secure the installation board
3. Plastic expanded tube		8	
4. Wrapping tape		1	
5. Drain pipe		1	
6. sealed tube cap		1	
7. Remote controller (including operation manual)		1	
8. Frame		1	Hold the remote controller
9. Mounting screw(ST2.9 × 10-C-H)		2	Insulation Holder for remote controller
10. Alkaline dry batteries (AM4)		2	
11. wall bushing		1	
12. Installation manual		1	This manual
13. Network matching wire		1	The indoor unit which at the terminal of communication system should connect a impedance between port P and port Q.
14. Copper nut		1	Connect piping

Cautions on remote controller installation:

- Never throw or beat the controller.
- Before installation, operate the remote controller to determine its location in a reception range.
- Keep the remote controller at least 1m apart from the nearest TV set or stereo equipment. (it is necessary to prevent image disturbances or noise interferences.)
- Do not install the remote controller in a place exposed to direct sunlight or close to a heating source, such as a stove.
- Note that the positive and negative poles are right positions when loading batteries.
- This manual is subject to changes due to technological improvement without further notices.

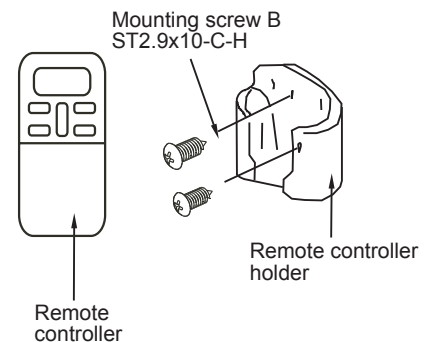



Fig.3-1

4. INSPECTING AND HANDLING THE UNIT

At delivery, the package should be checked and any damage should be reported immediately to the carrier claims agent.

When handling the unit, take into account the following:

- 1  Fragile, handle the unit with care.
-  Keep the unit upright in order to avoid compressor damage.
- 2 Choose on before hand the path along which the unit is to be brought in.
- 3 Move this unit as originally package as possible.
- 4 When lifting the unit , always use protectors to prevent belt damage and pay attention to the position of the unit's centre of gravity.

5. INDOOR UNIT INSTALLATION

5.1 Installation place

Installation in the following places may cause trouble.If it is unavoidable, please consult with the local dealer.

- A place full of machine oil.
- A saline place such as coast.
- A place full of sulfide gas such as hot-spring resort.
- Places where there are high frequency machines such as wireless equipment, welding
- Machine, and medical facility.
- A place there is no combustive gases and volatile matter.
- A place of special environmental conditions.

■ Indoor Unit

- A place where is no obstacle near the inlet and outlet area.
- A place which can bear the weight of the indoor unit.
- A place which allows the air filter to be removed.
- A place where the reception range is not Exposed to direct sunlight.
- A place where the connective pipe and drain hose is easy to led out.
- A place 1m or more to TV, radio instrument, in the center of the room is perfect.
- The indoor unit should be installed 2.5 meters or more above the floor.

5.2 Drilling A Hole and Mounting Installation Board

Installation Board and Its Direction (unit: mm)

71\80\90 type

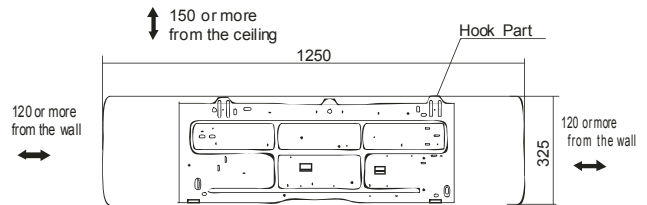

Fig.5-1

1 Fix the installation board.

- Install the installation board horizontally on structural parts in the wall with the spaces provided around the plate.
- In case of brick, concrete or similar type walls, make 5mm dia. holes in the wall. Insert clip anchors for appropriate mounting screws.
- Fix the installation board on the wall.

Right installation

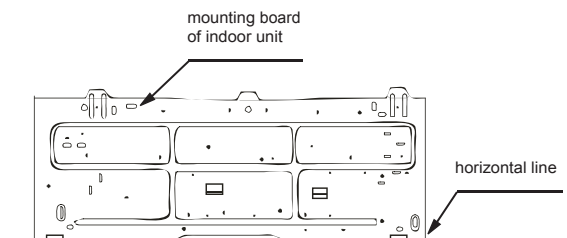
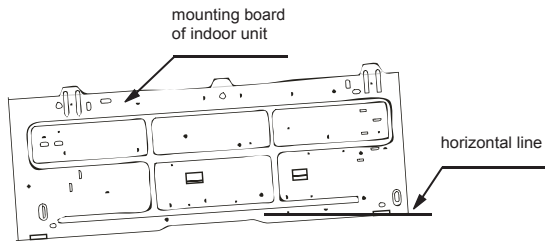
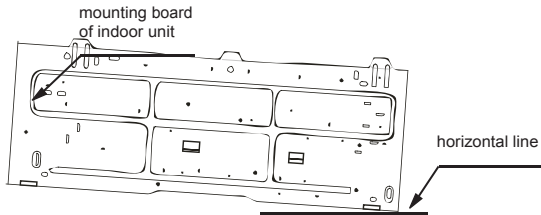

Fig.5-3

False installation



✗



✗

Fig.5-4

2 Drilling a hole.

- Determine the pipe hole position using the installation board, and drill the pipehole (N95mm) so it slants slightly downward.
- Always use a wall hole conduit when piercing metal lath, ply wood or metal plate.

5.3 Connective Pipe and Drainage Installation

1 Drainage

- Run the drain hose sloping downward. Do not install the drain hose as illustrated below.

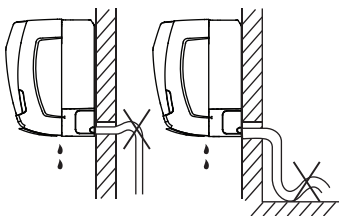

Do not form a rise

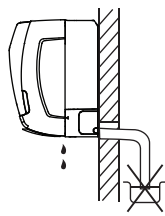

Do not put the hose end into water

Fig.5-5

- When connection extension drain hose,insulate the connecting part of extension drain hose with a shield pipe

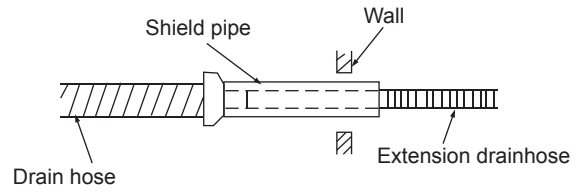

Fig.5-6

2 Connection pipe

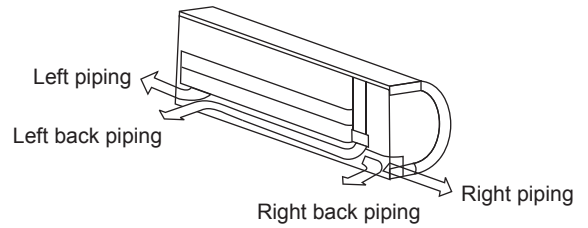

Fig.5-7

- For the left-hand and rear-left-hand piping,install the piping as shown. Bend the conn-ective pipe to be laid at 43mm height or less from the wall.

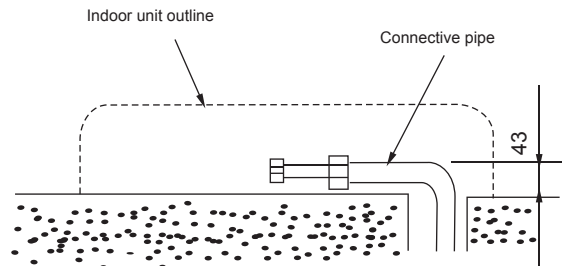

Fig.5-8

- Fix the end of the connective pipe.(Refer to Tightening Connection in REFRI-GERANT PIPING CONNECTION)



CAUTION

Connect the indoor unit first then the outdoor unit and bend and arrange the pipe carefully.

Do not allow the piping to let out from the back of the indoor unit.

Be careful not to let the drain hose slack.

Insulate both of the auxiliary piping.

Banding the drain hose under the auxiliary pipe.

Do not allow the piping to let out from the back of the indoor unit.

3 Piping and bandaging

Wind the connective cable, drain hose and wiring with tape securely, evenly as shown below.

- Because the condensed water from rear of the indoor unit is gathered in Pond Box and is piped out of room. Do not put anything else in the box.

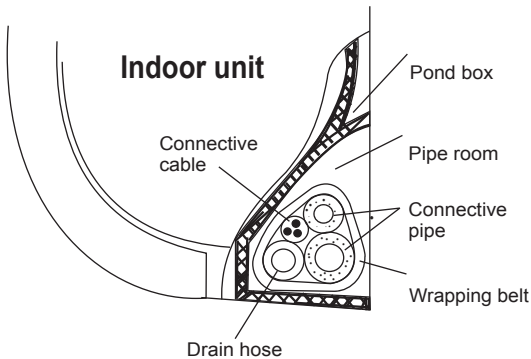

Fig.5-9

5.4 Indoor Unit Installation

- Pass the piping through the hole in the wall.
- Put the claw at the back of the indoor unit on the hook of the installation board, move the Indoor Unit from side to side to see that it is securely hooked.
- Piping can easily be made by lifting the indoor unit with a cushioning material between the indoor unit and the wall. Get it out after finish piping.
- Push the lower part of the Indoor Unit up to the wall, Then move the Indoor Unit from side to side, up and down to check if it is hooked securely.

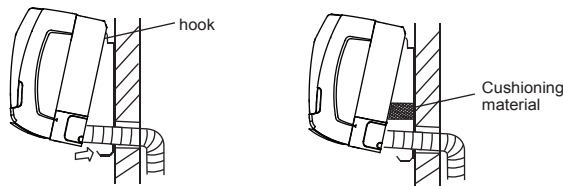

Fig.5-10

6. REFRIGERANT PIPE INSTALLATION



CAUTION

Ventilate the air if there was any refrigerant leakage during installation. Leaked refrigerant will generate poisonous gas if meeting fire.

Make sure there is no refrigerant leakage after installation. Leaked refrigerant will generate poisonous gas if meeting fire.

6.1 Allowed Length and Drop of Piping

Requirements are different when installing the Outdoor Unit, Please refer to Outdoor Unit Installation Manual for detailed information.

6.2 Material and Size of the Piping

Table 6-1

Pipe Material		Copper Pipe for Air Conditioner
Model		71/80/90
Size(mm)	(Gas side)	Φ15.9
	(Liquid side)	Φ9.5

6.3 Refrigerant Volume to Be Added

- Refrigerant Volume to be added is calculated according to Outdoor Unit Installation Manual.
- Be save to add refrigerant measuring by a scale.



CAUTION

If refrigerant volume added is inadequate (too much or insufficient), the compressor malfunction will be caused. Be sure to calculate the refrigerant volume carefully.

The service man should note down the piping length and refrigerant volume added on the nameplate, which is on the Electric Control Box Cover of outdoor unit for to diagnose the compressor when compressor malfunction occurs.

6.4 Connection of the Refrigerant Pipe

Connection of the refrigerant pipe should be done by professionals. Double-span should be used when connecting pipes of Indoor Unit.



CAUTION

The temperature of refrigerant circuit will be high, please keep the interconnection cable away from the copper tube.

- Tightening Torque

Table 6-2

Outer diameter(mm) of connection piping	Tightening Torque (N·m)
Φ6.4	14.2~17.2
Φ9.5	32.7~39.9
Φ12.7	49.5~60.3
Φ15.9	61.8~75.4
Φ19.1	97.2~118.6



NOTE

Please refer to installation instructions for the refrigerant piping connection of the air conditioner that with throttle device inside.

7. WIRING CHART

Model(W)		7100~9000
Power	Phase	1-Phase
	Frequency and volt	220-240V~ 50/60Hz
Manual switch/Insurance (A)		16/10
Indoor unit power wiring (mm ²)		3x2.5
Indoor/outdoor connecting wiring (mm ²) (3-core shielded wire)		3x0.75
Fuse (A)		8A

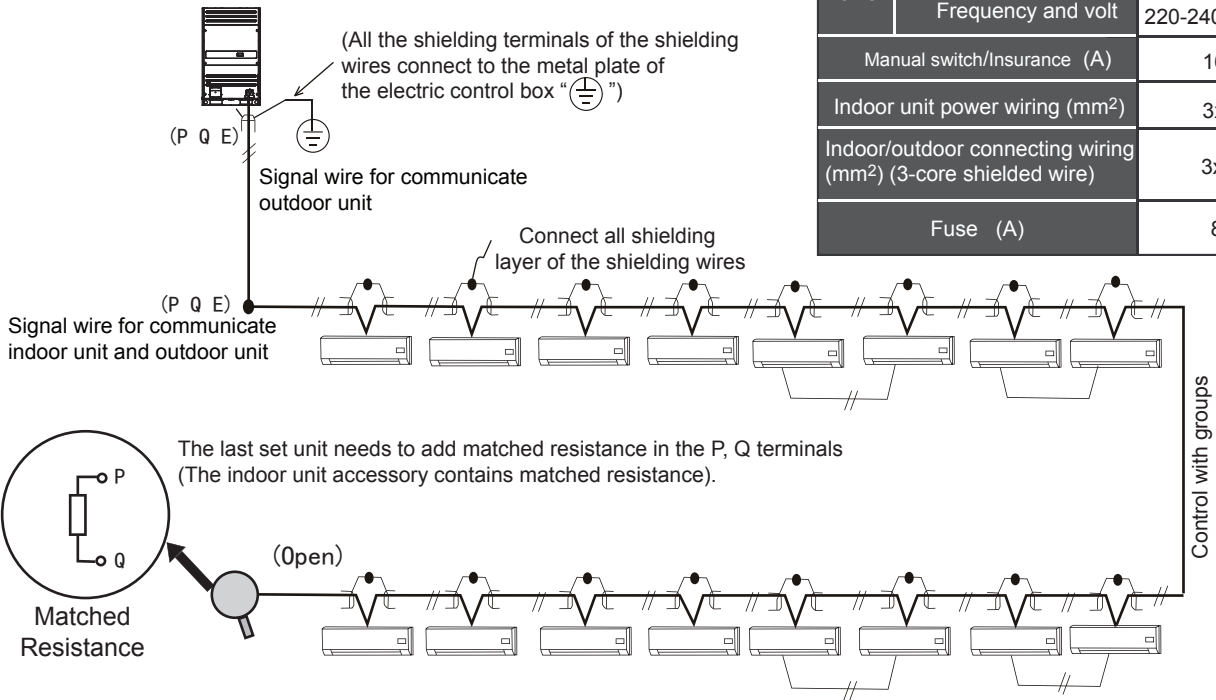

CAUTION

The reserved function is indicated in broken line table, users can select it when necessary.

1 Take out the faceplate, then dismantle the electronic control cover plate. (see Fig.7-1)

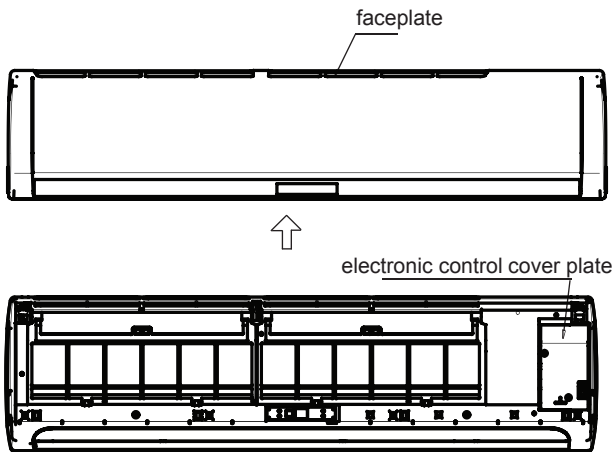

2 Individual connect the power cord and signal line, adjust the dial switch. (see Fig.7-2)

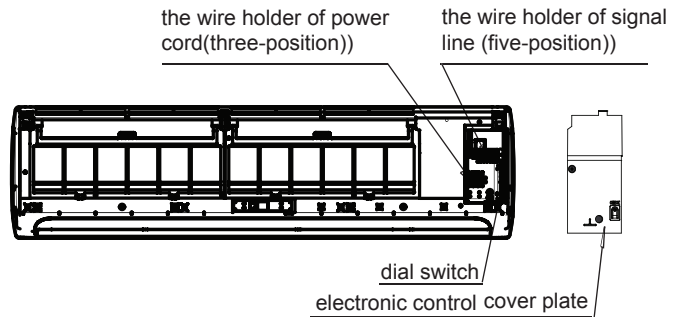

CAUTION

An all-pole disconnection device which has at least 3mm separation distance in all pole and a residual current device (RCD) with the rating of above 10mA shall be incorporated in the fixed wiring according to the national rule.

7.1 Terminal Board Diagram

Please refer to the indoor unit wiring diagram for the wiring.



NOTE

The air-conditioners can be connected with Central Control Monitor (CCM). Before operation, please wiring correctly and set system address and network address of indoor units.

Single phase indoor unit

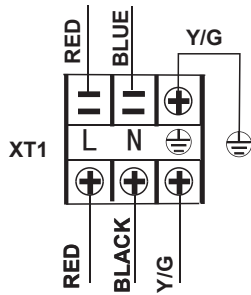

INDOOR UNIT POWER
220-240V~50/60Hz
(Conventional)

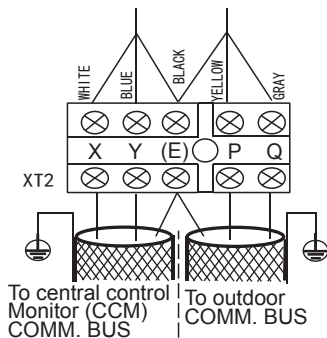

Please adopt the 3-core shielded wire, and connect the shielded layer to (E)

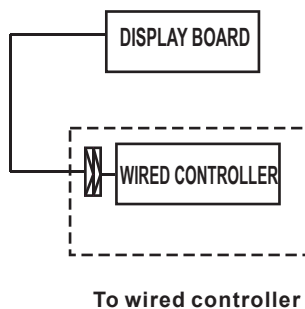

To wired controller

The reserved wired control function is indicated in broken line table, users can purchase the wired controller when necessary.

7.2 Horsepower set

Horsepower code

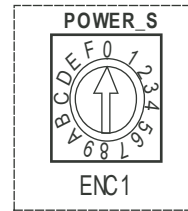

ENC1	Toggle switch	For set horsepower
	Code	Capacity(Horsepower)
	0	2200W(0.8HP)
	1	2800W(1.0HP)
	2	3600W(1.2HP)
	3	4500W(1.5HP)
	4	5600W(2.0HP)
	5	7100W(2.5HP)
	6	8000W(3.0HP)
	7	9000W(3.2HP)

Note: The horsepower has been set before leaving the factory, anyone can't modify it except the maintenance person.



CAUTION

The system together have 64units(0-63),everyone has only system addresscode,if two addresses are the same in one system, the abnormal operation will occur.

7.3 Network address set

- 1) Network address is set by communication of indoor and outdoor unit; the address is the same as indoor address, there is no need to set separately.
- 2) The central control of indoor units can be done on outdoor unit, there is no need to control indoor unit separately, for details please refer to V4+ outdoor unit manual.
- 3) For previous control of indoor units, the network can be set by connecting (X,Y,E) terminals, there is no need to set network address.

7.4 Main board Code designation

SW1 definition

<p>ON SW1 1 2 3 4</p>	<ul style="list-style-type: none"> ● 1 means factory test mode ● 0 means add. auto searching mode (default setting) 	<p>ON SW1 1 2 3 4</p>	<ul style="list-style-type: none"> ● 01 means DC fan static pressure is 1 (reserved)
<p>ON SW1 1 2 3 4</p>	<ul style="list-style-type: none"> ● 1 means DC fan Is chosen ● 0 means AC fan Is chosen 	<p>ON SW1 1 2 3 4</p>	<ul style="list-style-type: none"> ● 10 means DC fan static pressure is 2 (reserved)
<p>ON SW1 1 2 3 4</p>	<ul style="list-style-type: none"> ● 00 means DC fan static pressure is 0 (reserved) 	<p>ON SW1 1 2 3 4</p>	<ul style="list-style-type: none"> ● 11 means DC fan static pressure is 3 (reserved)

SW2 definition

<p>ON SW2 1 2 3 4</p>	<ul style="list-style-type: none"> ● 00 means the temperature is 15 degrees when shutting down the unit for cold wind proof. 	<p>ON SW2 1 2 3 4</p>	<ul style="list-style-type: none"> ● 00 means the time of stopping fan is 4 minutes
<p>ON SW2 1 2 3 4</p>	<ul style="list-style-type: none"> ● 01 means the temperature is 20 degrees when shutting down the unit for cold wind proof. 	<p>ON SW2 1 2 3 4</p>	<ul style="list-style-type: none"> ● 01 means the time of stopping fan is 8 minutes
<p>ON SW2 1 2 3 4</p>	<ul style="list-style-type: none"> ● 10 means the temperature is 24 degrees when shutting down the unit for cold wind proof. 	<p>ON SW2 1 2 3 4</p>	<ul style="list-style-type: none"> ● 10 means the time of stopping fan is 12 minutes
<p>ON SW2 1 2 3 4</p>	<ul style="list-style-type: none"> ● 11 means the temperature is 26 degrees when shutting down the unit for cold wind proof. 	<p>ON SW2 1 2 3 4</p>	<ul style="list-style-type: none"> ● 11 means the time of stopping fan is 16 minutes

SW5 definition

<p>ON SW5 1 2</p>	<ul style="list-style-type: none"> ● 00 means temperature compensation is 6 degrees under heating mode 	<p>ON SW5 1 2</p>	<ul style="list-style-type: none"> ● 10 means temperature compensation is 4 degrees under heating mode
<p>ON SW5 1 2</p>	<ul style="list-style-type: none"> ● 01 means temperature compensation is 2 degrees under heating mode 	<p>ON SW5 1 2</p>	<ul style="list-style-type: none"> ● 11 means temperature compensation is 8 degrees under heating mode

SW6 definition

<p>ON SW6 1 2 3</p>	<ul style="list-style-type: none"> ● 1 means old display board ● 0 means new display board
<p>ON SW6 1 2 3</p>	<ul style="list-style-type: none"> ● 1 means auto wind under auto mode ● 0 means auto wind under non auto mode
<p>ON SW6 1 2 3</p>	reserved

J1, J2 definition

<p>J1</p>	J1 no Jumpers means power off memory function
<p>J1</p>	J1 Jumpers means no power off memory function
<p>J2</p>	reserved

SW7 definition

	Standard configure
	Last one in the network

0/1 definition

	Means 0
	Means 1

8 TEST OPERATION



CAUTION

Protection function will delay the startup of compressor for 3 minutes in case the unit is turned on immediately after power on or restarted after shutdown.

- The test operation must be carried out after the entire installation has been completed.
- Please confirm the following points before the test operation:
 - The indoor unit and outdoor unit are installed properly.
 - Tubing and wiring are correctly completed.
 - The refrigerant pipe system is leakage-checked.
 - The drainage is unimpeded.
 - The heating insulation works well.
 - The ground wiring is connected correctly.
 - The length of the tubing and the added stow capacity of the refrigerant have been recorded.
 - The power voltage fits the rated voltage of the air conditioner.
 - There is no obstacle at the outlet and inlet of the outdoor and indoor and indoor units.
 - The gas-side and liquid-side stop valves are both opened.
 - The air conditioner is pre-heated by turning on the power.

- According to the user's requirement, install the remote controller frame where the remote controller's signal can reach the indoor unit smoothly.
- Test operation
 - Set the air conditioner under the mode of "COOLING" with the remote controller, and check the following points per the "Owner's Manual" if there is any malfunction, please resolve it through chapter "Troubles And Causes".
- The indoor unit
 - Whether the switch on the remote controller works well.
 - Whether the buttons on the remote controller works well.
 - Whether the air flow louver moves normally.
 - Whether the room temperature is adjusted well.
 - Whether the indicator lights normally.
 - Whether the temporary buttons works well.
 - Whether the drainage is normal.
 - Whether there is vibration or abnormal noise during operation.
 - Whether the air conditioner heats well in the case of the HEATING/COOLING type.
- The outdoor unit
 - Whether there is vibration or abnormal noise during operation.
 - Whether the generated wind, noise, or condensed water by the air conditioner have influenced your neighborhood.
 - Whether any of the refrigerant is leaked.

MD12I-021BW

202000172020