

DE	Montageanleitung	2
FR	Instructions de montage	2
EN	assembly instructions	3
IT	Istruzioni per Installazione	3
ES	Instrucciones de montaje	4
NL	Handleiding	4
DK	Monteringsvejledning	5
PT	Manual de Instalação	5
PL	Instrukcja montażu	6
CS	Montážní návod	6
SK	Montážny návod	7
ZH	组装说明	7
RU	Инструкция по монтажу	8
HU	Szerelési útmutató	8
FI	Asennusohje	9
SV	Monteringsanvisning	9
LT	Montavimo instrukcijos	10
HR	Uputstva za instalaciju	10
TR	Montaj kılavuzu	11
RO	Instrucțiuni de montare	11
EL	Οδηγία συναρμολόγησης	12
SL	Navodila za montažo	12
ET	Paigaldusjuhend	13
LV	Montāžas instrukcija	13
SR	Uputstvo za montažu	14
NO	Montasjeveiledning	14
BG	Ръководство за монтаж	15
SQ	Udhëzime rreth montimit	15
AR	تعليمات التجميع	16

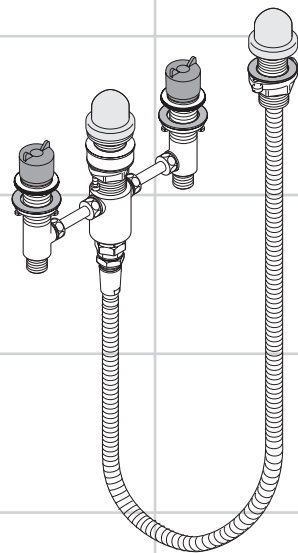

13244180

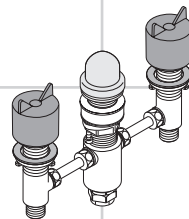

13233180



Sicherheitshinweise

- Bei der Montage müssen zur Vermeidung von Quetsch- und Schnittverletzungen Handschuhe getragen werden.
- Große Druckunterschiede zwischen den Kalt- und Warmwasseranschlüssen müssen ausgeglichen werden.

Montagehinweise

- Vor der Montage muss das Produkt auf Transportschäden untersucht werden. Nach dem Einbau werden keine Transport- oder Oberflächenschäden anerkannt.
- Die Armatur muss nach den gültigen Normen montiert, gespült und geprüft werden!
- Das Wannrandset muss so eingebaut werden, dass sämtliche Bauteile jederzeit zugänglich sind und bei Bedarf ausgetauscht werden können. Damit durch die Schlauchdurchführung eintretendes Wasser unter der Wanne keine Schäden verursachen kann, muss dieser Bereich gegen Leckwasser geschützt sein.
- Achtung! Es muß einmal jährlich eine Dichtheitsprüfung vorgenommen werden.

Symbolerklärung



Kein essigsäurehaltiges Silikon verwenden!



Maße (siehe Seite 17)



Serviceteile (siehe Seite 22)



Sonderzubehör

Secuflex Box 28389000 nicht im Lieferumfang!



Prüfzeichen (siehe Seite 24)



Fertigset (siehe Seite 20)

Montage

siehe Seite 18

Consignes de sécurité

- Lors du montage, porter des gants de protection pour éviter toute blessure par écrasement ou coupure.
- Il est conseillé d'équilibrer les pressions de l'eau chaude et froide.

Instructions pour le montage

- Avant son montage, s'assurer que le produit n'a subi aucun dommage pendant le transport. Après le montage, tout dommage de transport ou de surface ne pourra pas être reconnu.
- La robinetterie doit être installée, rincée et contrôlée conformément aux normes valables!
- Le support pour montage sur rebord de baignoire doit être posé de manière à ce que tous les éléments soient accessibles et puissent être échangés en cas de besoin. Pour éviter des dégâts causés par l'infiltration d'eau à travers le support de douche, il faut protéger le périmètre sous la baignoire.
- Attention! Faites une fois une épreuve de la fuite par année.

Description du symbole



Ne pas utiliser de silicone contenant de l'acide acétique!



Dimensions (voir page 17)



Pièces détachées (voir pages 22)



Accessoires en option

Secuflex Box 28389000 ne fait pas partie de la fourniture !



Classification acoustique et débit (voir page 24)



Set de finition (voir page 20)



Montage

voir page 18





Safety Notes

-  Gloves should be worn during installation to prevent crushing and cutting injuries.
-  The hot and cold supplies must be of equal pressures.

Installation Instructions

- Prior to installation, inspect the product for transport damages. After it has been installed, no transport or surface damage will be honoured.
- The fitting must be installed, flushed and tested after the valid norms!
- When installing the bath fitting set, it must be guaranteed, that each part can be within reached and if necessary removed. To avoid damages of entering water by the passage of the hose, the area under the tub must be protected against leaking water.
- Important! Do a leak test once a year.

Symbol description



Do not use silicone containing acetic acid!



Dimensions (see page 17)



Spare parts (see page 22)



Special accessories

Secuflex Box 28389000 not included!





Test certificate (see page 24)



Finish set (see page 20)

**Assembly
see page 18**

Indicazioni sulla sicurezza

-  Durante il montaggio, per evitare ferite da schiacciamento e da taglio bisogna indossare guanti protettivi.
-  Attenzione! Compensare le differenze di pressione tra i collegamenti dell'acqua fredda e dell'acqua calda.

Istruzioni per il montaggio

- Prima del montaggio è necessario controllare che non ci siano stati danni durante il trasporto. Una volta eseguito il montaggio, non verranno riconosciuti eventuali danni di trasporto o delle superfici.
- La rubinetteria deve essere installata, pulita e testata secondo le istruzioni riportate!
- L'installazione del set bordo vasca deve garantire la possibilità che ogni parte venga facilmente raggiunta e se necessario rimossa. Per evitare danni causati dall'infiltrazione di acqua attraverso il passaggio del tubo, la zona sotto la vasca deve essere protetta.
- Attenzione! Comprovare annualmente l'estanqueidad della rubinetteria.

Descrizione simbolo



Non utilizzare silicone contenente acido acetico!



Ingombri (vedi pagg. 17)



Parti di ricambio (vedi pagg. 22)



Accessori speciali

Secuflex Box 28389000 non nel volume di fornitura!



Segno di verifica (vedi pagg. 24)



Set esterno (vedi pagg. 20)

**Montaggio
vedi pagg. 18**





Indicaciones de seguridad

- ⚠ Durante el montaje deben utilizarse guantes para evitar heridas por aplastamiento o corte.
- ⚠ Grandes diferencias de presión en servicio entre agua fría y agua caliente deben equilibrarse.

Indicaciones para el montaje

- Antes del montaje se debe examinar el producto contra daños de transporte. Después de la instalación so se reconoce ningún daño de transporte o de superficie.
- El grifo tiene que ser instalado, probado y testado, según las normas en vigor.
- La parte empotrada de la grifería debe ser instalada de tal forma que todos los componentes son accesibles e intercambiables en cada momento. El área por debajo de la bañera debe ser protegida contra fugas de agua y/o disponer de un sumidero, para que el agua que entra a través del conducto del flexo no pueda causar daños.
- ¡Atención! Comprobar la estanqueidad de la grifería anualmente.

Descripción de símbolos



No utilizar silicona que contiene ácido acético!



Dimensiones (ver página 17)



Repuestos (ver página 22)



Opcional

Secuflex Box 28389000 no incluido en el suministro



Marca de verificación (ver página 24)



Embellecedor exterior (ver página 20)

Veiligheidsinstructies

- ⚠ Bij de montage moeten ter voorkoming van knel- en snijwonden handschoenen worden gedragen.
- ⚠ Grote drukverschillen tussen de koud- en warmwatertoevoer dienen vermeden te worden.

Montage-instructies

- Vóór de montage moet het product gecontroleerd worden op transportschade. Na de inbouw wordt geen transport- of oppervlakteschade meer aanvaard.
- Leidingen doorspoelen volgens Norm. De mengkraan vervolgens monteren en controleren!
- De badrandmengkraan moet zo worden geplaatst, dat men er achteraf altijd nog bij kan komen en onderdelen indien nodig uit kan wisselen. Om eventuele lekkage te vermijden, welke via de handdouche-doorvoer onder het bad zou kunnen ontstaan, dient de ruimte ruimte onder het bad beschermd te zijn tegen lekwater.
- **Attentie!** Eénmaal per jaar moet men deze ruimte op dichtheid testen.

Symboolbeschrijving



Gebruik geen zuurhoudende silicone!



Maten (zie blz. 17)



Service onderdelen (zie blz. 22)



Toebehoren

Secuflex Box 28389000 niet in leveringspakket!



Keurmerk (zie blz. 24)



Kleurset (zie blz. 20)





Montage
zie blz. 18

Montaje
ver página 18







Sikkerhedsanvisninger

-  Ved monteringen skal der bruges handsker for at undgå kvæstelser og snitsår.
-  Større trykforskelle mellem koldt og varmt vand bør udjævnes.

Monteringsanvisninger

- Før monteringen skal produktet kontrolleres for transportskader. Efter monteringen godkendes transportskader eller skader på overfladen ikke længere.
- Ifølge gældende regler, skal armaturet monteres, skylles igennem og afprøves.
- Indbygningsarmaturet til karrand skal installeres således, at samtlige indbygningsdele til hver en tid er tilgængelige og ved behov kan udskiftes. Slangegennemføringen skal sikres, således at der ikke kan trænge vand ind under karret.
- Advarsel! Der bør årligt foretages en tæthedsprøve.

Symbolbeskrivelse



-  Der må ikke benyttes eddikesyreholdig silikone!
-  **Målene** (se s. 17)
-  **Reserve dele** (se s. 22)
-  **Specialtilbehør**
Secuflex-boks 28389000 ikke med i leveringsomfang

 **Godkendelse** (se s. 24)

 **Kappesæt** (se s. 20)

Montering
se s. 18





Avisos de segurança

-  Durante a montagem devem ser utilizadas luvas de protecção, de modo a evitar ferimentos resultantes de entalamentos e de cortes.
-  Grandes diferenças entre as pressões das águas quente e fria devem ser compensadas.

Avisos de montagem

- Antes da montagem deve-se controlar o produto relativamente a danos de transporte. Após a montagem não são aceites quaisquer danos de transporte ou de superfície.
- A misturadora deve ser instalada, purgada e testada de acordo com as normas em vigor!
- Ao instalar o conjunto da misturadora de banheira, deve-se garantir que qualquer dos seus componentes deve ficar acessível e passível de remoção. Para evitar danos provocados pela eventual passagem de água pelo orifício do tubo flexível, o chão debaixo da banheira deve ser impermeabilizado e protegido contra eventuais fugas de água.
- Atenção! Faça um ensaio de fugas uma vez por ano.

Descrição do símbolo

-  Não utilizar silicone que contenha ácido acético!
-  **Medidas** (ver página 17)
-  **Peças de substituição** (ver página 22)
-  **Acessórios especiais**
Secuflex Box 28389000 não incluído no volume de fornecimento!

 **Marca de controlo** (ver página 24)

 **Conjunto completo** (ver página 20)

 **Montagem**
ver página 18



Wskazówki bezpieczeństwa

- △ Aby uniknąć zranień, takich jak zgniecenia czy przecięcia, podczas montażu należy nosić rękawice.
- △ Znaczne różnice ciśnień na dopływach ciepłej i zimnej wody muszą zostać wyrównane.

Wskazówki montażowe

- Przed montażem należy skontrolować produkt pod kątem szkód transportowych. Po montażu nie widać żadnych szkód transportowych ani szkód na powierzchni.
- Armatura musi być zamontowana, przepłukana i wypróbowana według obowiązujących norm!
- Zestaw krawędziowy wanny musi być zamontowany w taki sposób, by wszystkie podzespoły były dostępne w każdym czasie i w razie potrzeby można je było wymienić. W celu uniknięcia szkód powodowanych przez wnikającą wodę pod wannę, należy zabezpieczyć przed wodą przeciekową.
- Uwaga! Raz w roku należy podjąć kontrolę szczelności.

Bezpečnostní pokyny

- △ Pro zabránění řezným zraněním a pohmožděním je nutné při montáži nosit rukavice.
- △ Je nutné vyrovnat velké rozdíly tlaku mezi přípoji studené a teplé vody.

Pokyny k montáži

- Před montáží je třeba produkt zkontrolovat, zda nebyl při transportu poškozen. Po zabudování nebudou uznány žádné škody způsobené transportem nebo poškození povrchu.
- Armatura se musí montovat, proplachovat a testovat podle platných norem!
- Sada okrajů vany musí být namontována tak, aby byl možný vždy přístup ke všem dílům a tyto mohly být dle potřeby vyměněny. Aby voda přiváděná hadicovým provedením nemohla pod vanou způsobit žádnou škodu, je třeba tento prostor zajistit proti prosakující vodě.
- Pozor! Je třeba jednou ročně provést zkoušku těsnosti.

Opis symbolu



Nie stosować silikonów zawierających kwas octowy!



Wymiary (patrz strona 17)



Części serwisowe (patrz strona 22)



Wyposażenie specjalne

Secuflex Box 28389000 Nie jest częścią dostawy!



Znak jakości (patrz strona 24)



Elementy zewnętrzne (patrz strona 20)

Montaż

patrz strona 18

Popis symbolů



Nepoužívat silikon s obsahem kyseliny octové!



Rozměry (viz strana 17)



Servisní díly (viz strana 22)



Zvláštní příslušenství

Secuflex Box 28389000 není součástí dodávky



Zkušební značka (viz strana 24)



Vrchní sada (viz strana 20)

Montáž

viz strona 18





Bezpečnostné pokyny

- △ Pri montáži musíte nosiť rukavice, aby ste predišli pomliaždeninám a rezným poraneniam.
- △ Velké rozdiely v tlaku medzi prípojkami studenej a teplej vody musia byť vyrovnané.

Pokyny pre montáž

- Pred montážou musíte produkt skontrolovať, či nebol počas transportu poškodený. Po zabudovaní nebudú uznané žiadne škody spôsobené transportom alebo poškodenia povrchu.
- Batéria sa musí montovať, preplachovať a testovať podľa platných noriem!
- Sada okrajov vane musí byť namontovaná tak, aby bol vždy možný prístup ku všetkým dielom, a aby sa tieto dali vždy podľa potreby vymeniť. Aby voda privádzaná hadicovým prevedením nemohla pod vaňou spôsobiť žiadne škody, je potrebné tento priestor zaistiť
- Pozor! Raz ročne je potrebné vykonať skúšku tesnosti.

安全技巧

- △ 装配时为避免挤压和切割受伤，必须戴上手套。
- △ 冷热水管间过大的压力差必须予以平衡。

安装提示

- 安装前必须检查产品是否受到运输损害。安装后将不认可运输损害或表面损伤。
- 必须按照现行的规定安装，冲洗和测试产品！
- 所安装的面盆龙头必须使得所有构件随时可接触到并且在需要时可以进行更换。为确保穿透软管套管的水不会造成损失，必须防止该区域漏水。
- 注意！每年必须进行一次密封性检查。

Popis symbolov



Nepoužívať silikón s obsahom kyseliny octovej!



Rozmery (viď strana 17)



Servisné diely (viď strana 22)



Zvláštne príslušenstvo

Secuflex Box 28389000 nie je súčasťou dodávky



Osvedčenie o skúške (viď strana 24)



Vrchná sada (viď strana 20)

符号说明



请勿使用含有乙酸的硅！



大小 (参见第 17 页)



备用零件 (参见第 22 页)



选装附件

Secuflex盒子 28389000 不包括！



检验标记 (参见第 24 页)



加工件 (参见第 20 页)



Montáž
viď strana 18



安装
参见第 18 页



Указания по технике безопасности

-  Во время монтажа следует надеть перчатки во избежание прищемления и порезов.
-  донного клапа. Перед установкой смесителя необходимо регулировочными кранами выровнять давление холодной и горячей воды при помощи вентилей регулирующих подачу воды в квартиру.

Указания по монтажу

- Перед монтажом следует проверить изделие на предмет повреждений при перевозке. После монтажа претензии о возмещении ущерба за повреждения при перевозке или повреждения поверхности не принимаются.
- Смеситель должен быть смонтирован по действующим нормам и в соответствии с настоящей инструкцией, проверен на герметичность и безупречность работы
- При установке комплекта для ванн следует обеспечить доступ ко всем комплектующим и возможность их замены по мере необходимости. Во избежание ущерба при попадании воды под ванну в ходе прокладывания душевого шланга следует обеспечить защиту этого участка от протечек.
- **ВНИМАНИЕ!** Один раз в год следует проводить проверку на предмет герметичности.

Описание символов



Не применяйте силикон, содержащий уксусную кислоту.



Размеры (см. стр. 17)



Комплект (см. стр. 22)



Специальные принадлежности

Блок Secuflex 28389000 не поставляется в комплекте!





Знак технического контроля (см. стр. 24)



Наружная часть (см. стр. 20)

Монтаж
см. стр. 18

Biztonsági utasítások

-  A szerelésnél a zúzódások és vágási sérülések elkerülése érdekében kesztyűt kell viselni.
-  A hidegvíz- és a melegvíz-csatlakozások közötti nagy nyomáskülönbséget kikell egyenlíteni!

Szerelési utasítások

- A szerelés előtt ellenőrizni kell, hogy a terméknek nincs-e szállítási sérülése. Beépítés után a szállítási- vagy felületi sérüléseket nem ismerik el.
- A csaptelepelt az érvényben lévő előírásoknak megfelelően kell felszerelni, átöblíteni és ellenőrizni!
- A kádperem készletet úgy kell beépíteni, hogy minden alkatrész bármikor elérhető legyen, és szükség esetén ki lehessen cserélni. Azért, hogy a tömlőátvezetésen belépő víz ne okozzon károkat a kád alatt, ezt a területet szivárgó víz ellen védeni kell.
- Figyelem! Évente egyszer szivárgási ellenőrzést kell végezni.

Szimbólumok leírása



Ne használjon ecetsavtartalmú szilikon!



Méretet (lásd a 17. oldalon)



Tartozékok (lásd a 22. oldalon)



Egyéb tartozék

Secuflex Box 28389000 a szállítási egység nem tartalmazza!



Vizsgajel (lásd a 24. oldalon)



A kész szerelvény (lásd a 20. oldalon)

Szerelés
lásd a 18. oldalon





Turvallisuusohjeet

- △ Asennuksessa on käytettävä käsineitä puristumien ja viiltojen aiheuttamien tapaturmien estämiseksi.
- △ Suuret paine-erot kylmä- ja kuumavesiliitäntöjen välillä on tasattava.

Asennusohjeet

- Ennen asennusta on tarkastettava tuotteen mahdolliset kuljetusvahingot. Asennuksen jälkeen kuljetus- ja pintavaurioita ei hyväksytä.
- Kaluste on asennettava, huuhdeltava ja tarkastettava voimassa olevien määräysten mukaisesti!
- Kylpyammeen reunasetti on asennettava siten, että kaikki rakenneosat ovat vapaasti huollettavissa ja tarvittaessa vaihdettavissa. Jotta lenkun läpiviennistä sisään pääsevä vesi ei aiheuttaisi vahinkoja ammeen alla, alue on suojattava vuotavan veden varalta.
- Huomio! Tiivistarkastus on suoritettava kerran vuodessa.

Säkerhetsanvisningar

- △ Handskar ska bäras under monteringsarbetet så att man kan undvika kläm- och skärskadorna werden.
- △ Stora tryckskillnader mellan anslutningarna för varmt och kallt vatten måste utjämnas.

Monteringsanvisningar

- Det måste undersökas om produkten har transportskador innan den monteras. Efter monteringen accepteras inga transport- eller ytskiktsskador.
- Blandaren måste installeras, genomspolas och testas enligt gällande föreskrifter.
- Sargmonteringsssatsen måste placeras på sådant sätt att alla delar alltid är tillgängliga och kan bytas ut vid behov. Slanggenomföringen måste vara tätad så att vatten inte kan ta sig in under karet den här vägen och förorsaka skador.
- OBS! Tätheten måste kontrolleras en gång varje år.

Merkin kuvaus



Älä käytä etikkahappopitoista silikoniala



Mitat (katso sivu 17)



Varaosat (katso sivu 22)



Erityisvaruste

Secuflex Box 28389000 ei kuulu toimitukseen!



Koestusmerkki (katso sivu 24)



Valmissarja (katso sivu 20)

Asennus
katso sivu 18

Symbolförklaring



Använd inte silikon som innehåller ättiksyra!



Måtten (se sidan 17)



Reservdelar (se sidan 22)



Specialtillbehör

Secuflex Box 28389000 ingår ej i leveransen!



Testsigill (se sidan 24)





Färdigset (se sidan 20)



Montering
se sidan 18





Saugumo technikos nurodymai

-  Apsaugai nuo užspaudimo ir įsijpavimo montavimo metu mūvėkite pirštines.
-  Turi būti išlyginti šalto ir karšto slėgio nelygumai.

Montavimo instrukcija

- Prieš montuojant būtina patikrinti, ar gaminys nebuvo pažeistas transportavimo metu. Sumontavus pretenzijos dėl transportavimo ir paviršiaus pažeidimų nepriimamos.
- Maišytuvus privalo būti montuojamas, išleidžiamas ir patikrinamas pagal galiojančias normas!
- Vonios kraštai turi būti taip įstatomi, kad bet kurio metu būtų galima prieiti prie bet kurios dalies ir, reikaliui esant, ją pakeisti. Kad žarnomis tekantis vanduo po vonia nepridarytų žalos, šių zonų reikia izoliuoti nuo vandens, prisiskverbiančio pro kiauras vietas.
- Dėmesio! Kartą per metus reikia patikrinti sandarumą.

Sigurnosne upute

-  Prilikom montaže se radi sprječavanja prignječjenja i posjekotina moraju nositi rukavice.
-  Velika razlika u pritisku između vruće i hladne vode mora biti izbalansirana.

Upute za montažu

- Prije montaže mora se provjeriti je li proizvod oštećen prilikom transporta. Nakon ugradnje se ne priznaju nikakve reklamacije koje se odnose na površinska i transportna oštećenja.
- Cijevi moraju biti postavljene, isprane i testirane prema važećim normama!
- Svi elementi koji se ugrađuju na rubu kade moraju se tako postaviti da budu u svakom trenutku dostupni i po potrebi lako zamjenjivi. Kako voda koja curi sa crijeva tuša ne bi izazvala štetu ispod kade, navedeno se područje mora zaštititi od curenja vode.
- Pažnja! Jednom godišnje se mora provjeriti zabrtvljenost.

Simbolio aprašymas



Nenaudokite silikono, kurio sudėtyje yra acto rūgšties!



Išmatavimai (žr. psl. 17)



Atsarginės dalys (žr. psl. 22)



Specialūs priedai

„Secuflex“ dėžutė 28389000 nėra pridedama!



Bandymo pažyma (žr. psl. 24)



Virštinė (žr. psl. 20)

Opis simbola



Nemojte koristiti silikon koji sadrži octenu kiselinu!



Mjere (pogledaj stranicu 17)



Rezervni djelovi (pogledaj stranicu 22)



Posebni pribor

Secuflex Box 28389000 Nije sadržano u isporuci!



Oznaka testiranja (pogledaj stranicu 24)



Završni set (pogledaj stranicu 20)

Montavimas
žr. psl. 18



Sastavljanje
pogledaj stranicu 18



⚠️ Güvenlik uyarıları

- ⚠️ Montaj esnasında ezilme ve kesilme gibi yaralanmaları önlemek için eldiven kullanılmalıdır.
- ⚠️ Sıcak ve soğuk su bağlantıları arasında büyük basınç farklılıkları varsa, bu basınç farklılıklarının dengelenmesi gerekir.

Montaj açıklamaları

- Montaj işleminden önce ürün nakliye hasarları yönünden kontrol edilmelidir. Montaj işleminden sonra nakliye veya yüzey hasarları için sorumluluk üstlenilmemektedir.
- Batarya geçerli normlara göre monte edilmeli, yıkanmalı ve kontrol edilmelidir!
- Tekne kenarı seti, tüm yapı parçaları her zaman ulaşılabilir olacak ve gerektiğinde değiştirilebileceği şekilde monte edilmelidir. Hortumun içinden akan suyun teknenin altında herhangi bir hasara yol açmaması için, bu bölge su sızıntısına karşı korunmalıdır
- Önemli! Yılda bir kez sızdırmazlık testinin yapılması gereklidir.

⚠️ Instrucțiuni de siguranță

- ⚠️ La montare utilizați mănuși pentru evitarea contuziunilor și tăierii mâinilor.
- ⚠️ Diferențele de presiune mari între alimentarea cu apă rece și apă caldă trebuie echilibrate.

Instrucțiuni de montare

- Înainte de instalare verificați, dacă produsul prezintă deteriorări de transport. După instalare garanția nu acoperă deteriorările de transport și cele de suprafață.
- Bateria trebuie montată, clătită și verificată conform normelor în vigoare.
- Setul de la marginea căzii trebuie montat în așa fel, ca toate elementele construcționale să fie permanente accesibile pentru a putea fi schimbate la nevoie. Pentru ca apa, care se scurge prin garnitura de trecere a furtunului să nu poată cauza deteriorări
- Atenție! Se va efectua o verificare în privința etanșeității o dată pe an!

Simge açıklaması



Asetik asit içeren silikon kullanmayın!



Ölçüleri (Bakınız sayfa 17)



Yedek Parçalar (Bakınız sayfa 22)



Özel aksesuarlar

Secuflex Box 28389000 Teslimat kapsamına dahil değildir!



Kontrol işareti (Bakınız sayfa 24)



Dışı set (Bakınız sayfa 20)

Descrierea simbolurilor



Nu utilizați silicon cu conținut de acid acetic!



Dimensiuni (vezi pag. 17)



Piese de schimb (vezi pag. 22)



Accesorii opționale

Boxă secuflex 28389000 nu sunt incluse în setul livrat!



Certificat de testare (vezi pag. 24)



Set complet (vezi pag. 20)



Montajı
Bakınız sayfa 18

Montare
vezi pag. 18



Υποδειξεις ασφαλείας

- ⚠ Για να αποφύγετε τραυματισμούς κατά τη συναρμολόγηση πρέπει να φοράτε γάντια.
- ⚠ Οι διαφορές της πίεσης μεταξύ της σύνδεσης κρύου και ζεστού νερού θα πρέπει να αντισταθμίζονται.

Οδηγίες συναρμολόγησης

- Πριν τη συναρμολόγηση πρέπει να εξεταστεί το προϊόν για ζημιές μεταφοράς. Μετά την εγκατάσταση δεν αναγνωρίζονται ζημιές από τη μεταφορά ή επιφανειακές ζημιές.
- Η κεντρική βάνα πρέπει να τοποθετηθεί, να πλυθεί και να ελεγχθεί με βάση τους ισχύοντες κανόνες υδραυλικής τέχνης!
- Το σετ στην άκρη της μπανιέρας πρέπει να εγκαθίσταται έτσι, ώστε όλα τα εξαρτήματα να είναι προσβάσιμα ανά πάσα στιγμή και εφόσον χρειάζεται να μπορούν να αντικαθιστανται. Για να μην μπορεί να προξενήσει ζημιές το νερό που εισέρχεται από το πέρασμα του ελαστικού σωλήνα κάτω από τη μπανιέρα, πρέπει η περιοχή αυτή να προστατευθεί κατάλληλα ώστε να μην σημειωθεί διαρροή.
- Προσοχή! Πρέπει να εκτελείται μία φορά το χρόνο ένας έλεγχος στεγανότητας.

Varnostna opozorila

- ⚠ Pri montaži je treba nositi rokavice, da se preprečijo poškodbe zaradi zmečkanja ali urezov.
- ⚠ Il est conseillé d'équilibrer les pressions de l'eau chaude et froide.

Navodila za montažo

- Pred montažo je treba izdelke preveriti glede morebitnih transportnih poškodb. Po vgradnji transportne ali površinske poškodbe ne bodo več priznane.
- Armatura je potrebno montirati, sprati in testirati v skladu z veljavnimi normami!
- Komplet robov za kad se mora vgraditi tako, da so vsi elementi vedno dosegljivi in se lahko po potrebi zamenjajo. Da voda, ki vstopa skozi uvodnico gibke cevi, pod kadjo ne more povzročiti škode, je treba to območje zaščititi pred iztekaajočo vodo.
- Pozor! Enkrat na leto je treba izvesti preizkus tesnosti.

Περιγραφή συμβόλων



Μην χρησιμοποιείτε σιλικόνη που περιέχει οξικό οξύ!



Διαστάσεις (βλ. σελίδα 17)



Ανταλλακτικά (βλ. σελίδα 22)



Ειδικά αξεσουάρ

Κουτί Secuflex 28389000 δεν περιλαμβάνεται στον παραδοτέο εξοπλισμό



Σήμα ελέγχου (βλ. σελίδα 24)



Σετ μηχανισμού (βλ. σελίδα 20)

Opis simbola



Ne smete uporabiti silikona, ki vsebuje očetno kislino!



Mere (glejte stran 17)



Rezervni deli (glejte stran 22)



Poseben pribor

Secuflex Box 28389000 Ni vključeno!



Preskusni znak (glejte stran 24)



Zaključna garnitura (glejte stran 20)





Montaža
Glejte stran 18.

Συναρμολόγηση
βλ. σελίδα 18





Ohutusjuhised

-  Kandke paigaldamisel muljumis- ja löikevigastuste vältimiseks kindaid.
-  Kui külma ja kuuma vee ühenduste surve on väga erinev, tuleb need tasakaalustada.

Paigaldamisjuhised

- Enne paigaldamist tuleb toodet kontrollida transportkähjustuste osas Pärast paigaldamist ei tunnustata enam transporti- või pinnakähjustuste kaebuseid.
- Segisti paigaldamine, loputamine ja kontroll peab toimuma vastavalt kehtivatele normidele!
- Vanniäärekomplekt tuleb paigaldada nii, et kõigile selle komponentidele pääseks alati ligi ja neid saaks vajadusel asendada. Et vooliku läbiviigust tulev vesi ei tekitaks vanni alla kähjustusi, tuleb see piirkond lekkiva vee eest kaitsta.
- Tähelepanu! Kord aastas tuleb teha tiheduse kontroll.

Drošības norādes

-  Montāžas laikā, lai izvairītos no saspiedumiem un iegriezumiem, nepieciešams nēsāt cimdus.
-  Jāizvairās no spiediena atšķirības starp aukstā un karstā ūdens pievadiem.

Norādījumi montāžai

- Pirms montāžas nepieciešams pārbaudīt, vai produktam transportēšanas laikā nav radušies bojājumi. Pēc iebūvēšanas bojājumi, kas radušies transportēšanas laikā, vai virsmas bojājumi netiek atzīti.
- Armatūra jāuzstāda, jāizskalo un jāpārbauda atbilstoši spēkā esošajām normām!
- Vannas malām jābūt iebūvētām tā, lai visas būvniecības detaļas vienmēr būtu pieejamas un nomaināmas pēc nepieciešamības. Lai caur uzstādīto cauruli ienākošais ūdens zem vannas nevarētu izraisīt nekādus bojājumus, šī vieta ir jāaizsargā no ūdens noplūdes.
- Uzmanību! Reizi gadā ir jāveic blīvējuma pārbaude.

Sümbolite kirjeldus

 Ärge kasutage äädikhapet sisaldavat silikooni!

 **Mõõtude** (vt lk 17)

 **Varuosad** (vt lk 22)

 **Spetsiaalne lisavarustus**
Secuflex-karp 28389000 ei sisaldu komplektis

 **Kontrollsertifikaat** (vt lk 24)

 **Valmiskomplekt** (vt lk 20)

**Paigaldamine
vt lk 18**

Simbolu nozīme

 Neizmantot silikonu, kas satur etiķskābi!

 **Izmērus** (skat. 17. lpp.)

 **Rezerves daļas** (skat. 22. lpp.)

 **Speciāli aksesuāri**
Secuflex kārba 28389000 neietilpst komplektā!

 **Pārbaudes zīme** (skat. 24. lpp.)

 **Komplekts** (skat. 20. lpp.)

**Montāža
skat. 18. lpp.**





Sigurnosne napomene

- ⚠ Prilikom montaže se radi sprečavanja prignječena i posekotina moraju nositi rukavice.
- ⚠ Velika razlika u pritisku između vruće i hladne vode mora biti izbalansirana.

Instrukcije za montažu

- Pre montaže se mora proveriti da li je proizvod oštećen pri transportu. Nakon ugradnje se ne priznaju nikakve reklamacije koje se odnose na površinska i transportna oštećenja.
- Armatura mora biti postavljena, isprana i testirana prema važećim normama!
- Svi elementi koji se ugrađuju na ivici kade moraju se tako postaviti da budu u svakom trenutku dostupni i da se po potrebi mogu zameniti. Da voda koja curi sa creva tuša ne izazove štetu ispod kade, ta oblast mora da se zaštići od curenja vode.
- Pažnja! Jednom godišnje se mora proveriti zaprtivenost.

Sikkerhethenvisninger

- ⚠ Bruk hansker under montasjonen for å unngå klem- og kuttskader.
- ⚠ Store trykkdifferanser mellom kaldt- og varmtvannstilkoblinger skal utlignes.

Montagehenvisninger

- Før montasjonen skal produktet sjekkes for transportskader. Etter monteringen aksepteres ikke noen transport- eller overflateskader.
- Armaturen skal monteres iht. gyldige standarder. De skal spyles og sjekkes!
- Settett for karkanten skal bygges inn slik at alle komponenter til enhver tid er lett tilgjengelige og at de kan byttes ut etter behov. Fordi at vannet som lekker gjennom slangegjennomføringer ikke skal forårsake skader under badekaret, skal dette området beskyttes mot lekkasjevann.
- Obs! En gang i året skal det utføres en tetthetskontroll.

Opis simbola



Nemojte koristiti silikon koji sadrži sirćetnu kiselinu!



Mere (vidi stranu 17)



Rezervni delovi (vidi stranu 22)



Poseban pribor

Secuflex Box 28389000 Nije sadržano u isporuci!



Ispitni znak (vidi stranu 24)



Završni set (vidi stranu 20)

Symbolbeskrivelse



Ikke bruk silikon som inneholder eddiksyre!



Mål (se side 17)



Serviceleder (se side 22)



Ekstratilbehør

Secuflex Box 28389000 ikke medlevert!



Prøvemærke (se side 24)



Ferdigsett (se side 20)



Montaža



vidi stranu 18

Montasje

se side 18





Указания за безопасност

-  При монтажа трябва да се носят ръкавици, за да се избегнат наранявания поради притискане или порязване.
-  Големите разлики в налягането между изводите за студената и топлата вода трябва да се изравняват.

Указания за монтаж

- Преди монтажа продуктът трябва да се провери за транспортни щети. След монтажа не се признават транспортни или повърхностни щети.
- Арматурата трябва да се монтира, промие и провери в съответствие с валидните норми!
- Наборът за ръба на ваната трябва да се монтира така, че всички елементи да бъдат достъпни по всяко време и да могат да бъдат сменени при необходимост. За да не се предизвикват повреди под ваната при прекарване на маркучите, тази област трябва да бъде защитена от пропуски на вода.
- Внимание! Веднъж годишно трябва да се проверява херметичността.

Udhëzime sigurie

-  Për të evituar lëndimet e pickimeve ose të prerjeve gjatë procesit të montimit duhet që të vishni doreza.
-  Ndryshimet e mëdha të presionit mes lidhjeve të ujit të ftohtë dhe atij të ngrohtë duhen ekuilibruar.

Udhëzime për montimin

- Përpara montimit duhet që produkti të kontrollohet për dëmtime nga transporti. Pas instalimit nuk do të njihet asnjë dëmtim nga transporti ose dëmtim i sipërfaqes.
- Armatura duhet montuar, shpërlarë dhe kontrolluar në bazë të normave të vlefshme!
- Komplet i buzës së vaskës duhet montuar në atë mënyrë që të gjitha pjesët e ndërrimit të mund të ndërrohen në rast nevoje. Zona nën vaskë duhet të jetë e mbrojtur ndaj ujit me qëllim që një rrjedhje eventuale e ujit nga zorra poshtë vaskës të mos shkaktojë dëme.
- Kujdes! Një herë në vit duhet kontrolluar se a rrjedh uji.

Описание на символите



Не използвайте силикон, съдържащ оцетна киселина!



Размери (вижте стр. 17)



Сервизни части (вижте стр. 22)



Специални принадлежности

Кутия Secuflex 28389000 не е в обема на доставка



Контролен знак (вижте стр. 24)



Готов набор (вижте стр. 20)

Përshkrimi i simbolit



Mos përdorni silikon që në përbërje ka acid acetik.



Përmasat (shih faqen 17)



Pjesë ndërrimi (shih faqen 22)



Pajisje të posaçme

Kutia Secuflex 28389000 nuk përfshihet në vëllimin e furnizimit!



Shenja e kontrollit (shih faqen 24)



Komplet i gatshëm (shih faqen 20)

Монтаж

вижте стр. 18



Montimi

shih faqen 18



تنبيهات الأمان

⚠ يجب إرتداء قفازات لليد أثناء التركيب لتجنب حدوث أخطار الإنتحثار أو الجروح.

⚠ يجب أن يكون تيار الماء الساخن والماء البارد متعادلين في الضغط.

تعليمات التركيب

- قبل القيام بعملية التركيب، يجب فحص المنتج للتأكد من خلوه من أية تلفيات ناتجة عن النقل. بعد القيام بعملية التركيب، لن يتم الاعتراف بوجود أية تلفيات سطحية أو تلفيات ناتجة عن عملية النقل.
- يجب تركيب الوصلة، وغمرها بالماء واختبارها وفقاً للمعايير السارية!
- يجب تركيب مجموعة حواف البانيو بطريقة تسمح بالوصول لجميع قطع الغيار في جميع الأوقات حتى يمكن استبدالها إذا لزم الأمر. حتى لا يحدث الماء الداخل عن طريق فتحة الخرطوم تحت البانيو أية أضرار، يجب حماية هذا النطاق من تسرب الماء.
- تنبيه! يجب عمل اختبار سنوي على جلب منع التسرب.

وصف الرمز

هام! لا تستخدم السليكون الذي يحتوي على أحماض!



أبعاد (راجع صفحة 17)



قطع الغيار (راجع صفحة 22)



ملحقات خاصة

صندوق Secuflex 28389000 غير مدرج!



شهادة اختبار (راجع صفحة 24)



مجموعة كاملة. (راجع صفحة 20)



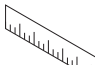

13244180

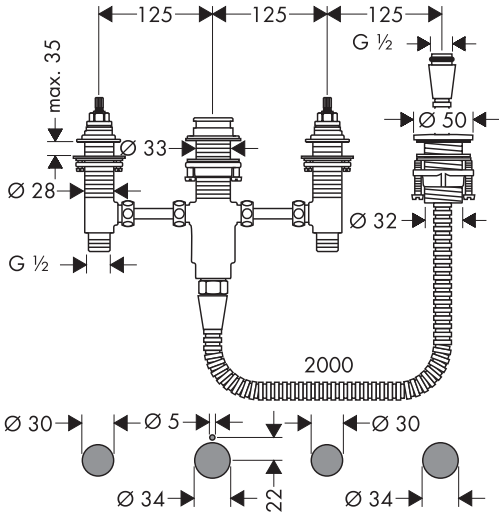

13233180

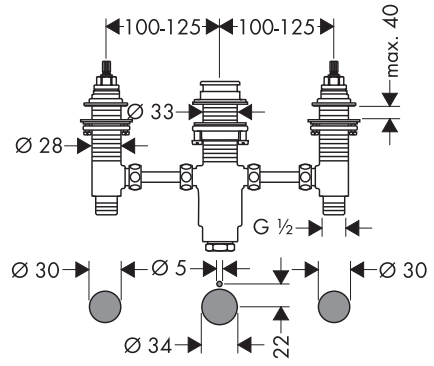

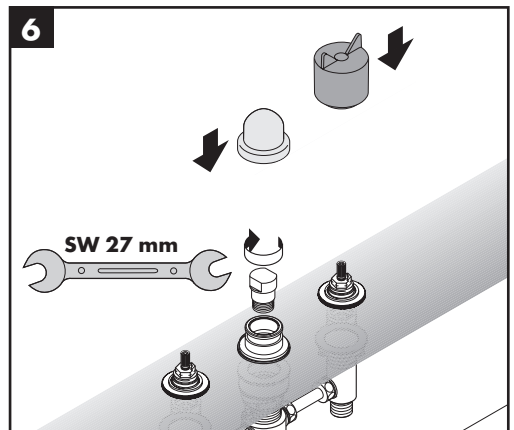
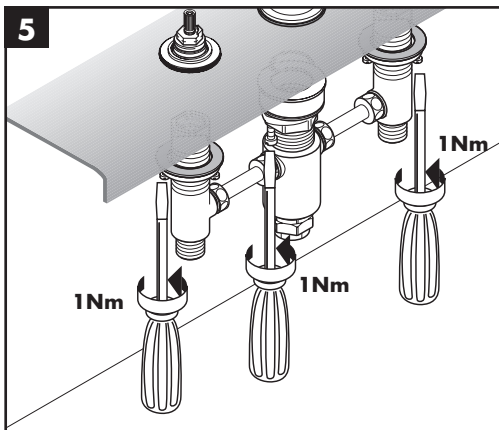
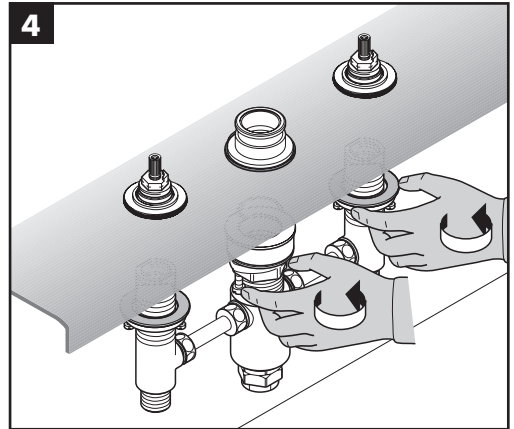
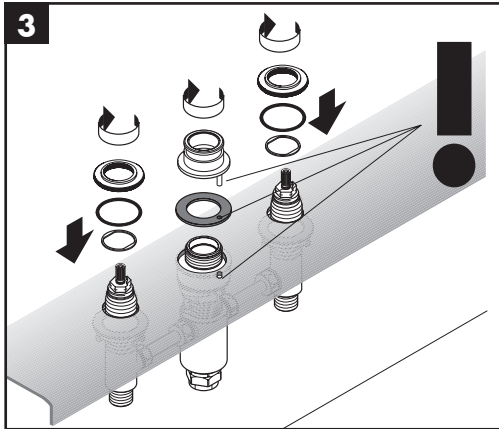
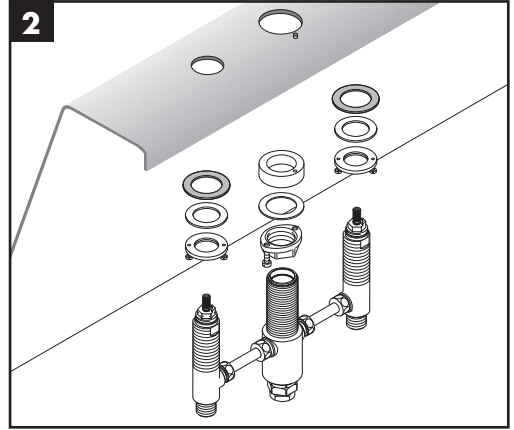
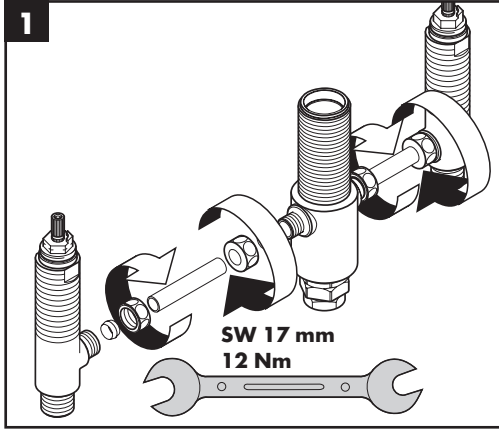

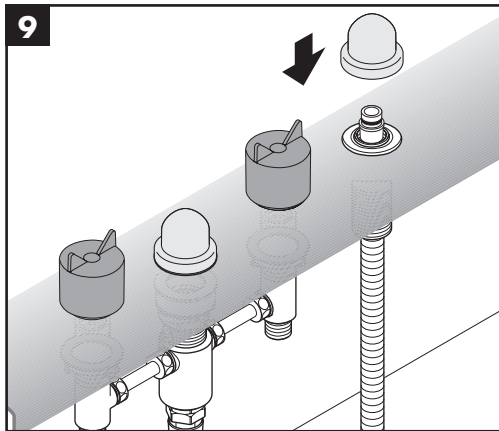
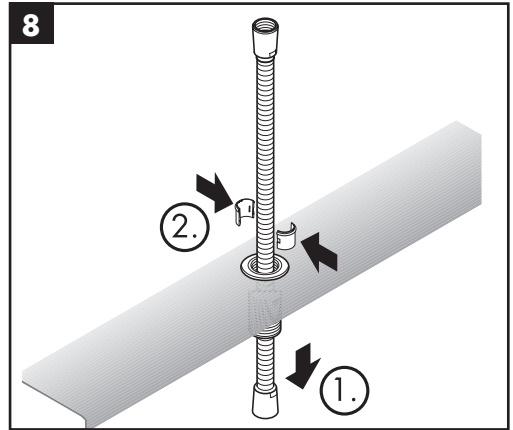
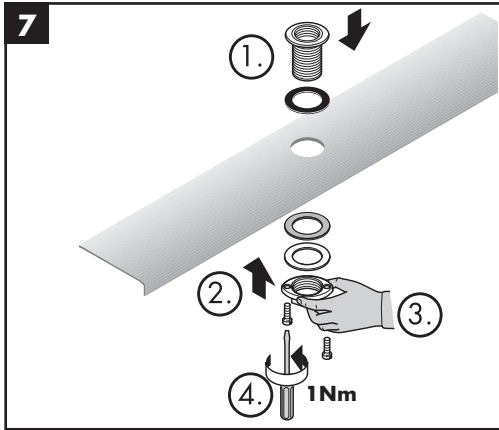



Talis S 32313000

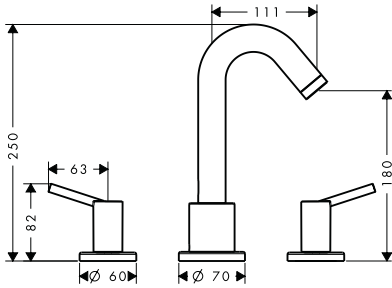

Focus S 31747000

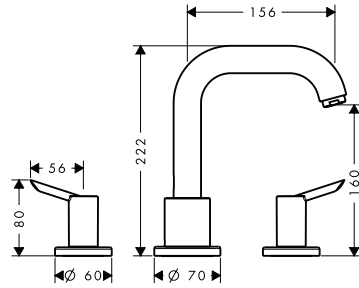

Metris S 31436000

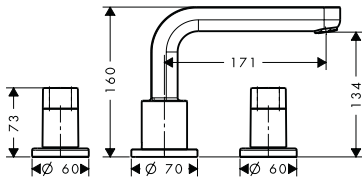

Metris Classic 31313000

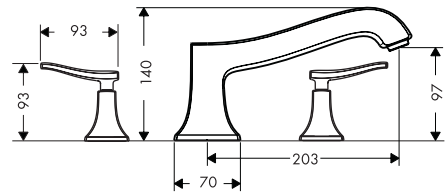

Urquiola 11436000

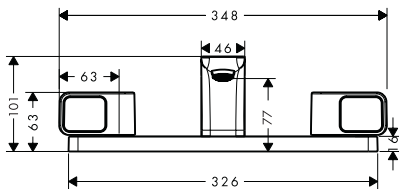

Citterio 39436000

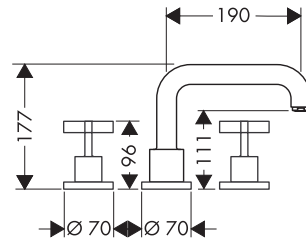



Talis S 32314000

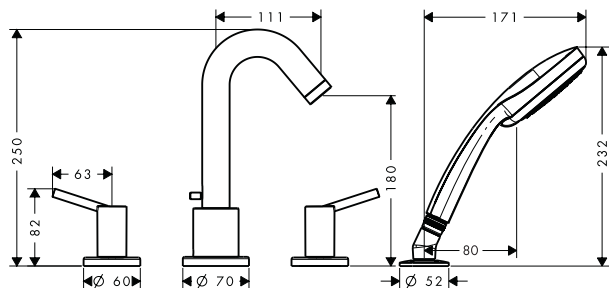

Focus S 31758000

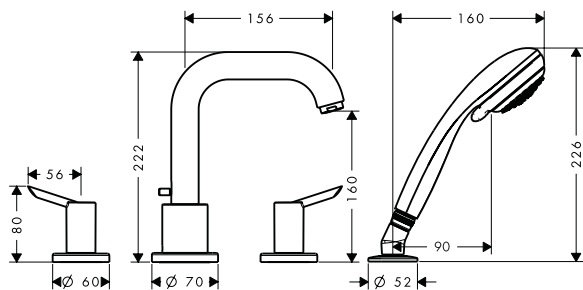

Metris S 31446000

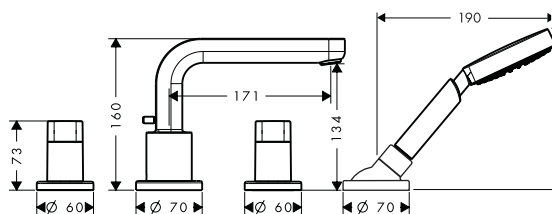

Metris Classic 31314000

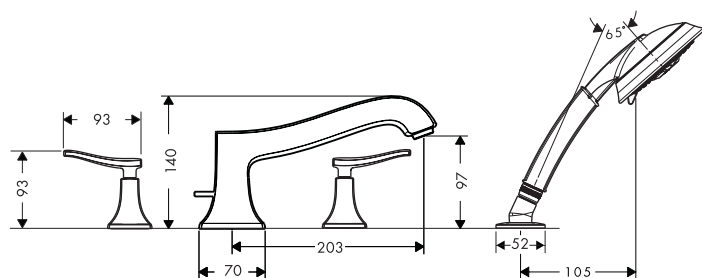

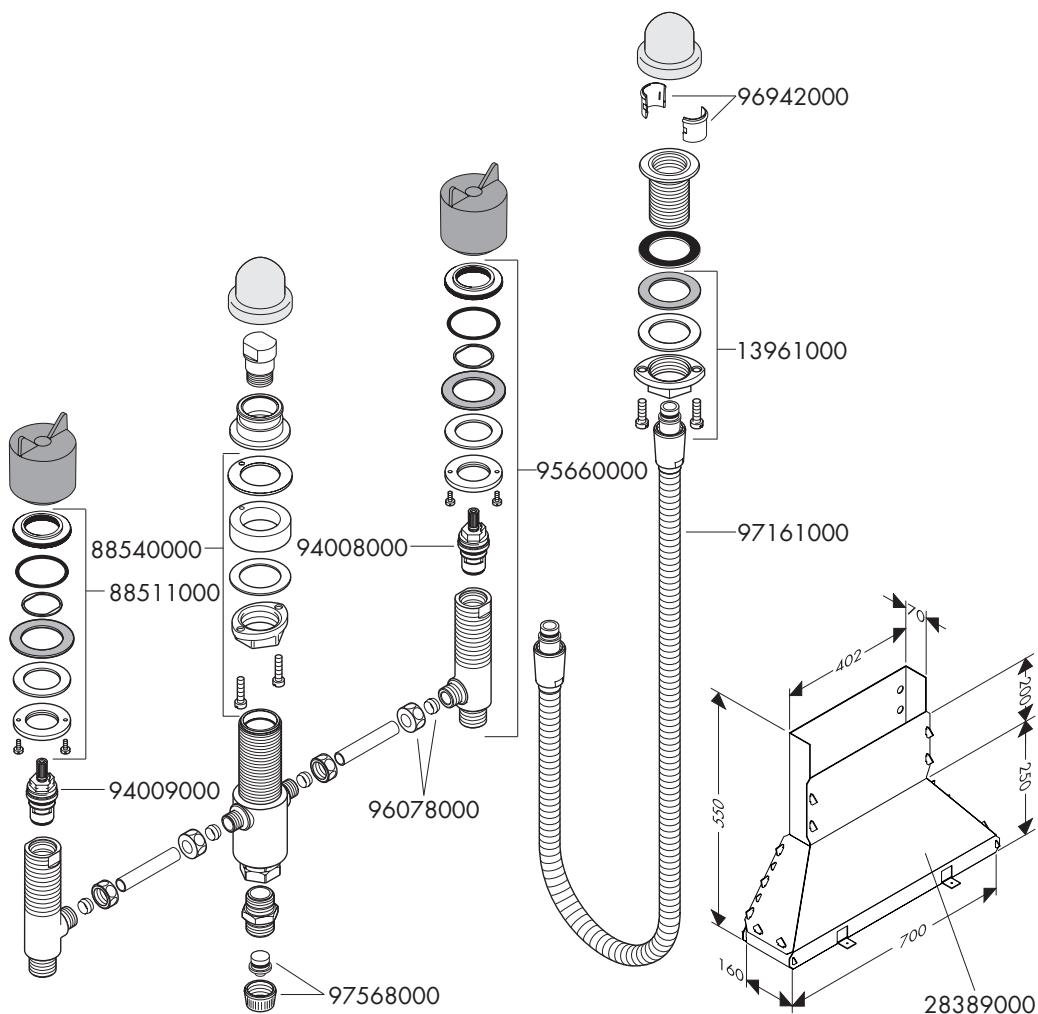



P-IX

DVGW

SVGW

ACS

WRAS

ETA

13233180

 1.42/19731

13244180
