

**onninen**

# UNDERSKÅP 40 / ALLASKAAPPI 40

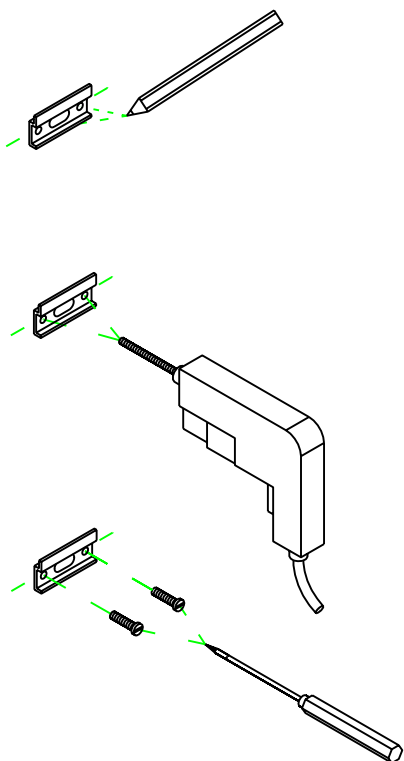

ANVÄND EN TRÅKLOTS PÅ UNDERSIDAN VID BORRING FÖR ATT UNDVIKA SPRICKOR I YTSKIKTET

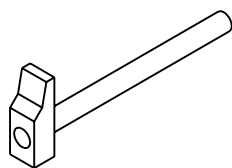
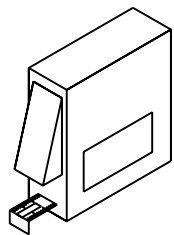
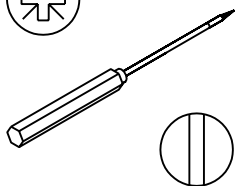
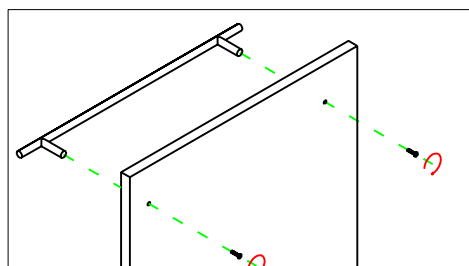
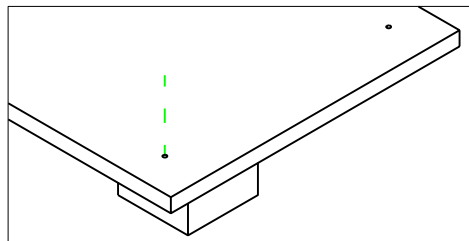

OBS :  
DÖRREN KAN INTE SPEGELVÄNDAS EFTER BORRING I LUCKAN

BESLAGEN KAN INTE AVMONTERAS EFTER MONTAGE I SKÅPSIDAN

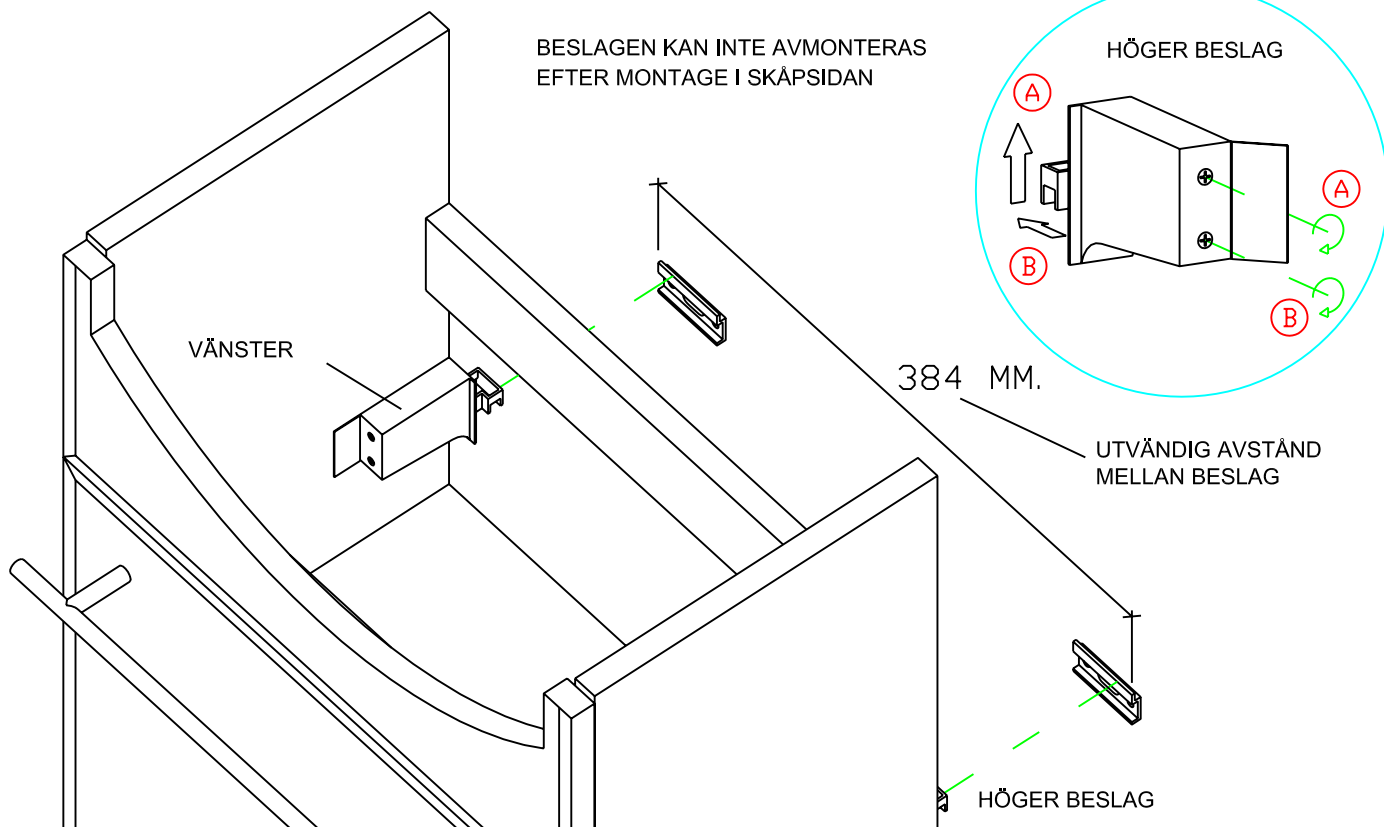

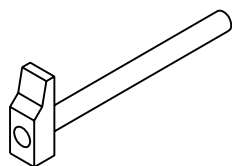
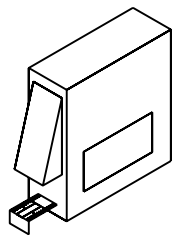
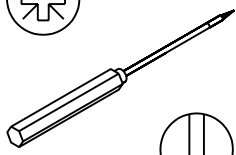

ÄNDRA HÄNGNING AV LUCKA - HÖGER TILL VÄNSTER

1

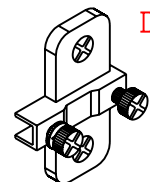
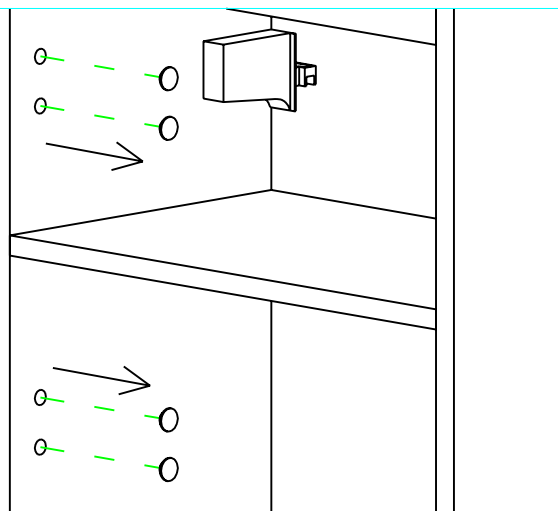

2

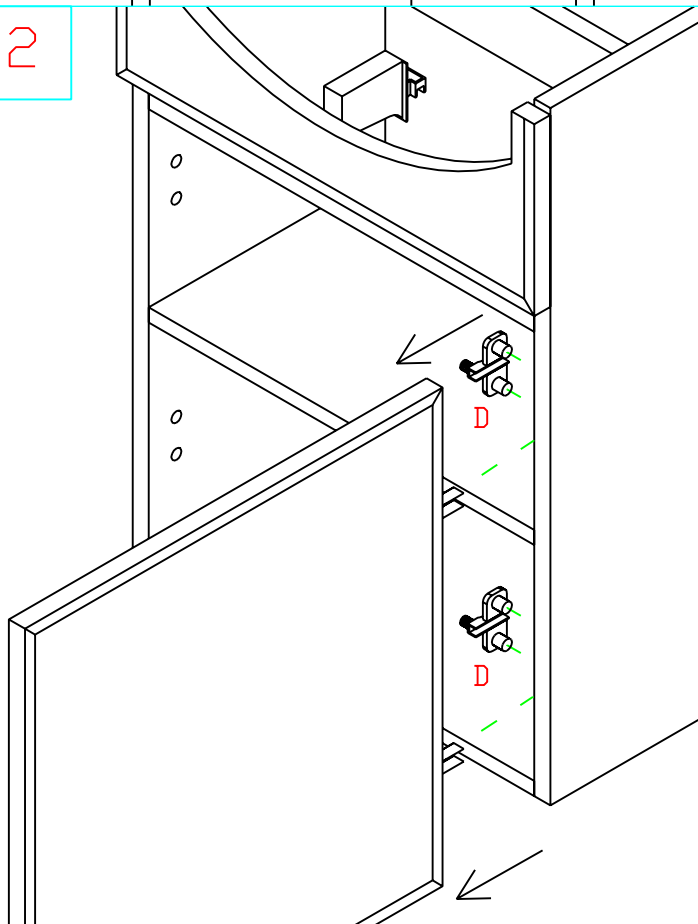

3

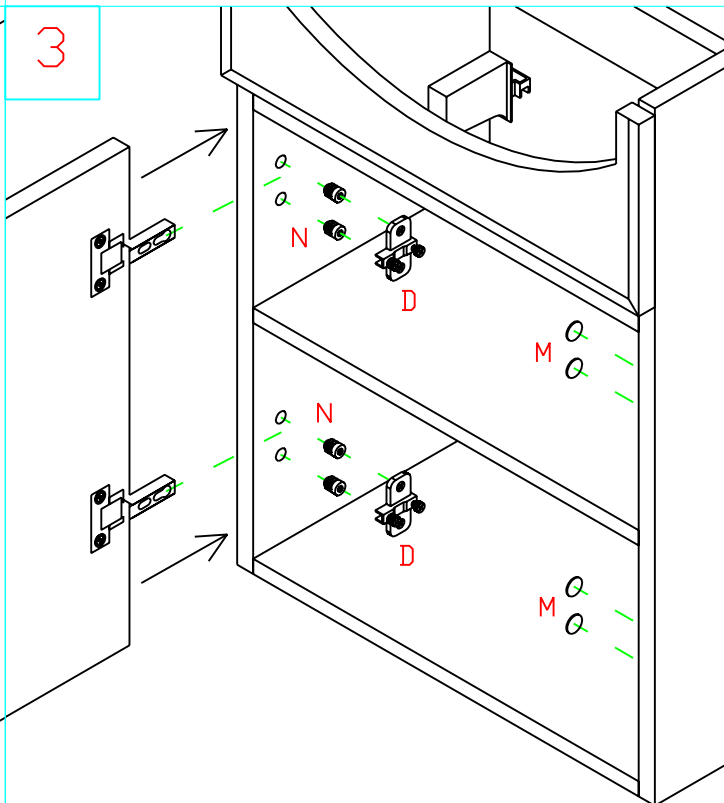

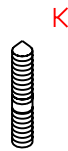
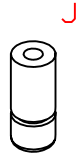
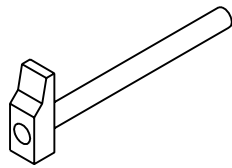
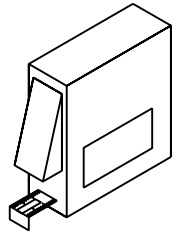
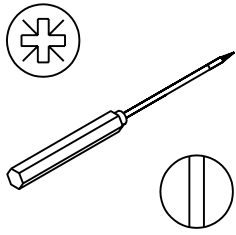

1

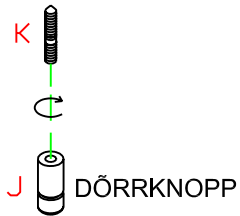

2

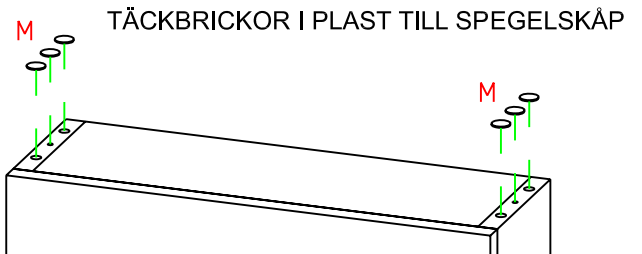
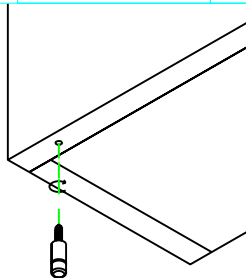

3

SKRUVAS MOT VÄGG

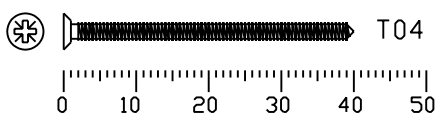
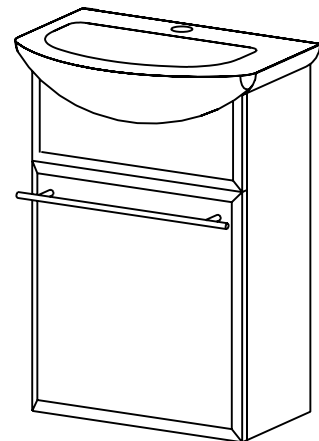
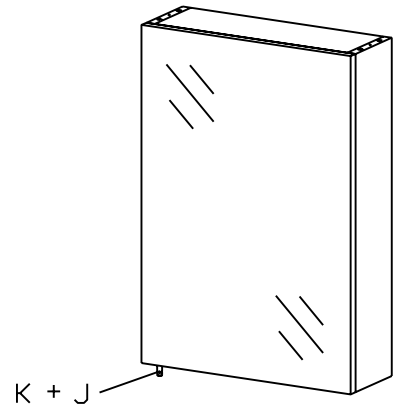
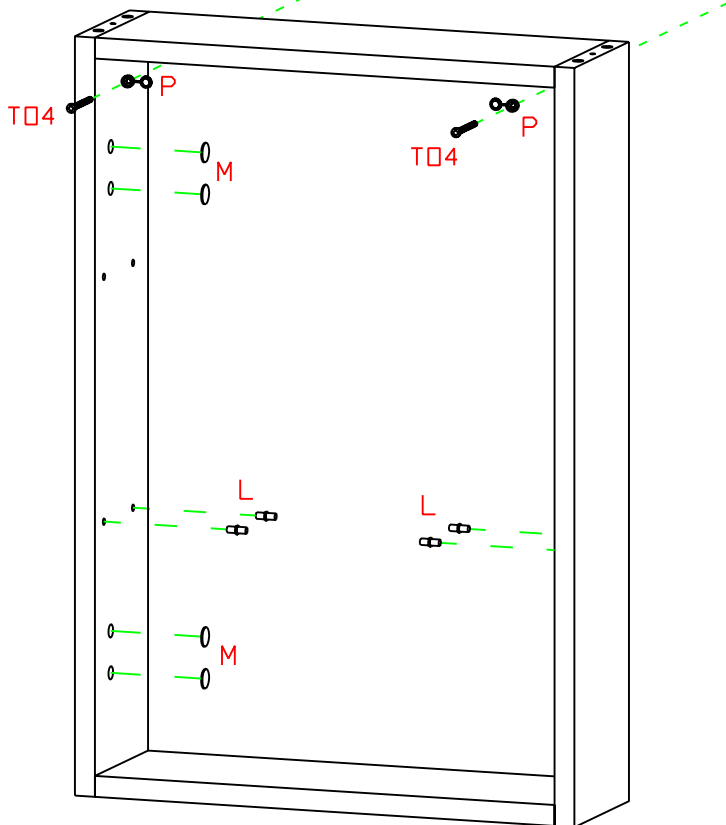

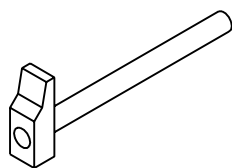
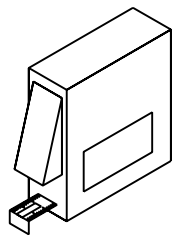
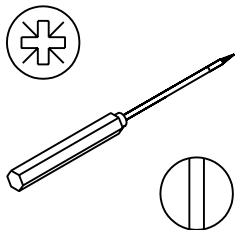

ÄNDRA HÄNGNING AV LUCKA - HÖGER TILL VÄNSTER

1

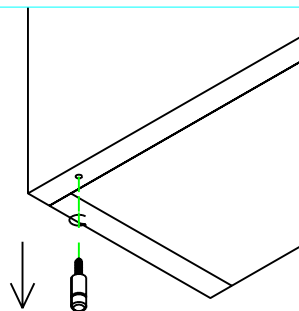

2

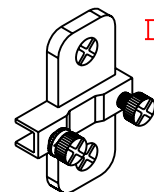
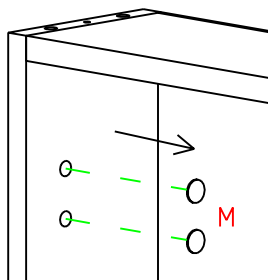

N



3

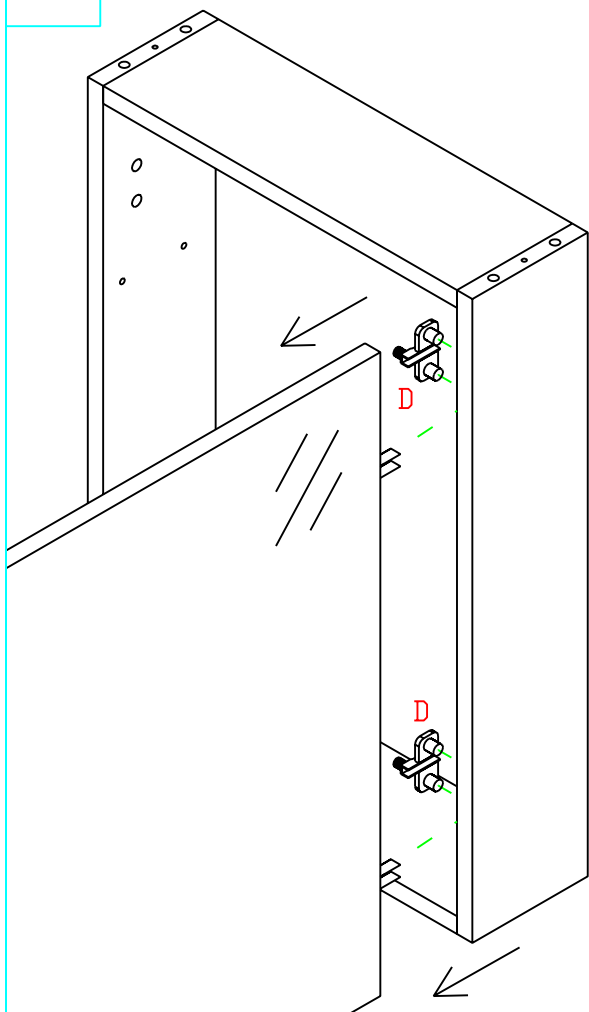

4

