

R410A **eagle**

Packaged air cooled liquid chillers for outdoor installation



42 ÷ 574 kW



## INDEX

EUROVENT CERTIFICATION .....	3
GENERAL CHARACTERISTICS.....	3
SERIES IDENTIFICATION .....	3
MODEL IDENTIFICATION .....	4
WORKING LIMITS.....	5
MAIN COMPONENTS .....	7
OPTIONAL ACCESSORIES.....	9
TECHNICAL DATA.....	10
ACOUSTIC DATA.....	16
ELECTRIC DATA .....	17
MP.COM: MICROPROCESSOR CONTROL SYSTEM.....	18
OPTIONAL ACCESSORIES - “HYG” HYDRONIC GROUP .....	19
OPTIONAL ACCESSORIES - “HAL” HYDRONIC GROUP .....	21
OPTIONAL ACCESSORIES - WATER PUMPS PERFORMANCES.....	23
OPTIONAL ACCESSORIES - LNO KIT.....	25
OPTIONAL ACCESSORIES - ELN KIT .....	29
OPTIONAL ACCESSORIES – “EC” AXIAL FANS.....	30
OPTIONAL ACCESSORIES - PARTIAL HEAT RECOVERY SYSTEM .....	31
OPTIONAL ACCESSORIES - TOTAL HEAT RECOVERY SYSTEM.....	32
MACHINE DRAWINGS .....	33

## EUROVENT CERTIFICATION



**This product has been certified by Eurovent.**

**RC GROUP SpA** participates in the **EUROVENT** program for: LCP and HHP (Liquid Chilling Packages and Hydronic Heat Pumps).

Check ongoing validity of certification on-line: [www.eurovent-certification.com](http://www.eurovent-certification.com)

## GENERAL CHARACTERISTICS

Packaged air cooled liquid chillers for chilled water production.

The machines are made with weather resistant materials and suitable for outdoor installation.

Framework with sections of thick steel for high resistance to the greatest stress during handling and transport.

Machines supply fully assembled with refrigerant charge and control systems. The installation requires electrical and hydraulic connections only allowing high costs and time reduction.

Final assembly on all machines before shipment including running test, reading and monitoring of operating parameters, alarms simulation and visual check.

Design, assembly and test as per the Company Quality Assurance program in full compliance with ISO 9001. RC Group has been the first Italian company in its segment to get the ISO 9001 in October 13<sup>th</sup>, 1991 with certificate ICIM 0018.

The machines are in full compliance with European Norms 2006/42CE, 2006/95CE, 2004/108CE, 97/23CE and subsequent amendments.

## SERIES IDENTIFICATION

**Machines size “U”** - Machines equipped with two condensing coils in vertical position, scroll compressors, axial fans and welded plate heat exchangers. Horizontal air suction and vertical discharge.

**EAGLE “U”** - Liquid chiller

S version: single refrigerant circuit  
Cooling capacity 42,1 ÷ 289,0 kW

D version: double refrigerant circuit  
Cooling capacity 41,8 ÷ 198,0 kW



**Machines size “Y”** - Machines equipped with two condensing coils in “V” position, scroll compressors, axial fans and welded plate heat exchangers. Horizontal air suction and vertical discharge.

**EAGLE “Y”** - Liquid chiller

D version: double refrigerant circuit  
Cooling capacity 242,0 ÷ 574,0 kW



## MODEL IDENTIFICATION

**EAGLE T 70 P 2 U 6 S**

**T Power supply**

T Three-phase 400/3/50+N or 400/3/50

**70 Cooling capacity (kW) at nominal conditions**

**P Compressor type**

P Scroll fully-hermetic R410A

**2 Compressors number**

**U Cabinet**

**6 Cabinet size**

**S Refrigerant circuit**

S Single refrigerant circuit

D Double refrigerant circuit

## WORKING LIMITS

### COOLING – chilled water production

Working limits diagram for chilled water production according to the ambient temperature and chilled water outlet temperature.

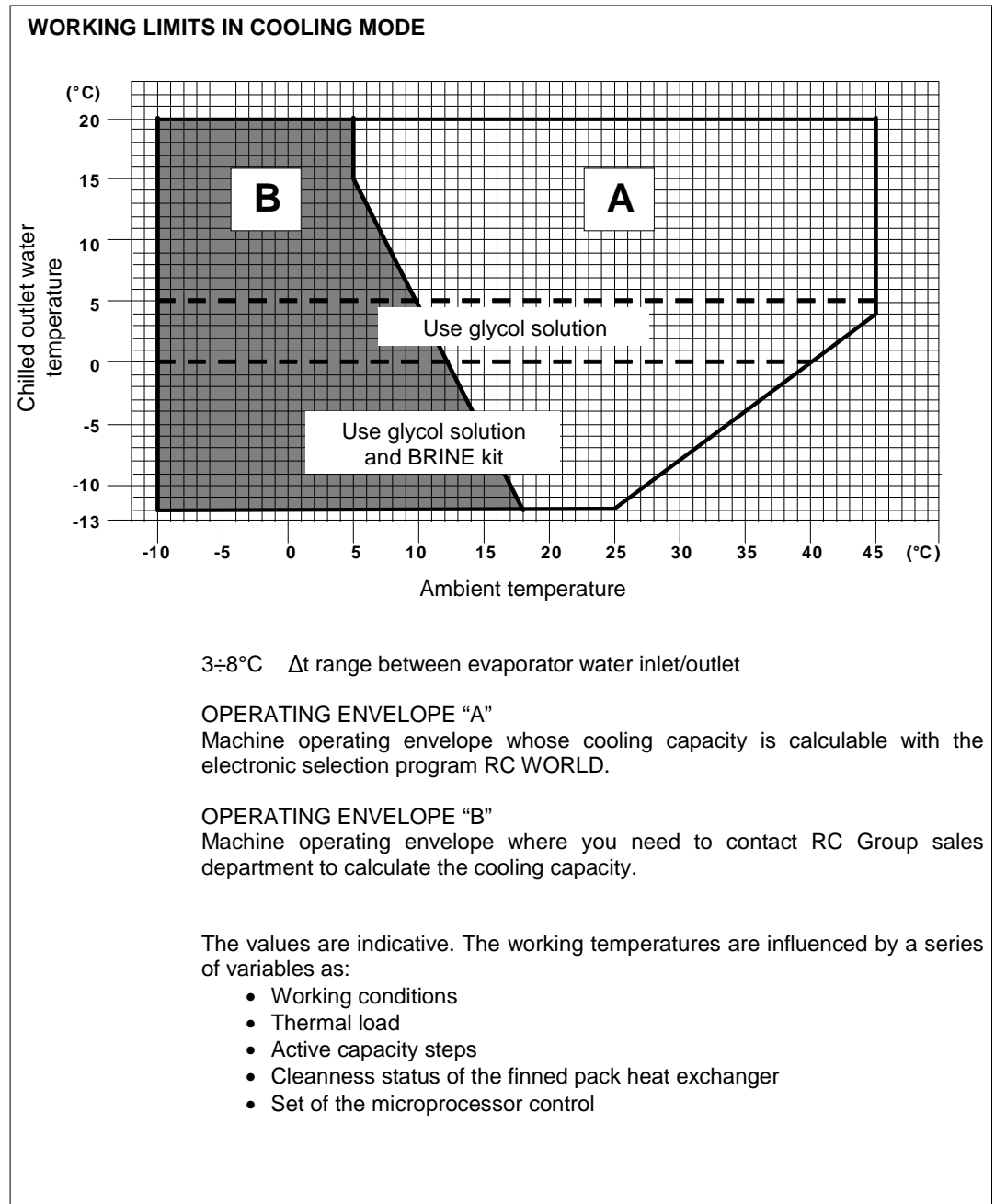

### PARTIAL HEAT RECLAIM

Working limits for hot water production from partial heat reclaim system.

The system is not regulated and the heating capacity which is supplied depends on the machine working conditions.

40÷75°C hot water outlet temperature range

5÷15°C  $\Delta t$  range between water inlet/outlet

### TOTAL HEAT RECLAIM

Working limits for hot water production from total heat reclaim system.

The system is totally controlled by the microprocessor and the heating capacity which is supplied depends on the microprocessor set.

30÷60°C hot water outlet temperature range

3÷8°C Δt range between water inlet/outlet

### ANTIFREEZE MIXTURES

Antifreeze mixtures has to be used when the machine working conditions foresees the chilled outlet liquid temperature lower than 5°C.

#### PROPYLENE GLYCOL

Chilled outlet liquid temperature from the machine	°C	4	2	1	-2	-4	-6	-9	-12
Percentage in weight of the mixture	%	5	10	15	20	25	30	35	40

#### ETHYLENE GLYCOL

Chilled outlet liquid temperature from the machine	°C	4	2	0	-4	-7	-9	-10	-13
Percentage in weight of the mixture	%	5	10	15	20	25	30	35	40

### WARNING

The values are referred to machine working temperature and not to freezing temperature of the used liquid.

The use of antifreeze mixtures causes a reduction of the machine performance, Please refer to the RC WORLD electronic catalogue to obtain the effective performance.

### STORING TEMPERATURE

If the machine is not installed on receipt and is stored for a long time, store it in a protected place, at temperatures ranging between -30°C and 50°C in absence of superficial condensation and direct sun light.

## MAIN COMPONENTS

### FRAMEWORK

- Base, self supporting frame and panelling in steel plate with protective surfaces treatment in compliance with UNI ISO 9227/ASTMB117 and ISO 7253, and painted with epoxy powders.
- Compressors compartment for machine size "U".
- Colour: RAL 9002

### COMPRESSORS

- Orbiting spiral (SCROLL) hermetic compressors with spiral profile optimized for R410A refrigerant.
- ON / OFF capacity control (0 / 100% each compressor).
- 2-pole 3-phase electric motor with direct on line starting.
- Phase sequence electronic relay.
- Crankcase heater.
- Electric motor thermal protection via internal winding temperature sensors.
- Rubber supports.

### EVAPORATOR

- Copper brazed plate type with cover plates, plates and connections in AISI 316 stainless steel:
  - With single refrigerant circuit for S version machines.
  - With double refrigerant circuit for D version machines.
- Antic condensate insulation made of polyurethane.
- Temperature sensors on water inlet and outlet.
- Differential water pressure switch for water flow control, for machines size "U".
- Water flow switch for water flow control, for machine size "Y".
- Antifreeze heater for machine size "Y".

### CONDENSING COIL

- Heat exchanger coil with internally corrugated copper tubes and high efficiency aluminium fins, specifically developed to provide high heat transfer and lower pressure drops. The combination of two factors, special tubes and fins, allow to optimally combine the following aspects:
  - Maximum capacity relative to the size of the exchanger.
  - Minimum charge of refrigerant.
  - Reduction of the air flow required for the heat exchange.
- Sub-cooling circuit to allow a significant increase in cooling capacity.
- Frame in galvanized steel.

### FANS SECTION

- Axial fans with sickle-shaped blades, fan guard and optimized for low noise levels.
- External rotor electric motor with stepless variable speed for condensing pressure control.
- IP54 enclosure class.

### REFRIGERANT CIRCUIT

Components for each refrigerant circuit:

- Thermostatic expansion valve up to model T 150 P2 included.
- Electronic expansion valve from model T 170 P4 included. The valve allows high performance and system efficiency thanks to a timely and accurate response to changes in temperature and pressure.  
The expansion valve is equipped with energy reserve to allow the closure of the valve in the event of lack of power supply.
- Sight glass.
- Electromagnetic valve on liquid line up to model T 150 P2 included. The electromagnetic valve is not installed when the electronic expansion valve is present.
- Filter dryer on liquid line.
- Service valves on liquid line and gas discharge.
- Safety valve on low pressure side.
- Pressure transducers with indication, control and protection functions, on low and high refrigerant pressure.
- High pressure safety switch with manual reset.
- Refrigerant circuit with copper tubing with antic condensate insulation of the suction line.
- Plastic capillary hoses for pressure sensors connection.
- R410A refrigerant charge.

#### ELECTRICAL PANEL

In accordance with EN60204-1 norms, suitable for outdoor installation, IP54 enclosure class, complete with:

- Main switch with door lock safety.
- Magnetothermic switch or fuses for each compressor.
- Magnetothermic switches for fans or water pumps (if scheduled).
- Contactors for each load.
- Transformer for auxiliary circuit and microprocessor supply.
- Panel with machine controls.
- Power supply:
  - 400/3/50+N up to model T 70 P2 included.
  - 400/3/50 for the other models.

#### CONTROL SYSTEM

- MP.COM microprocessor system with graphic display for control and monitor of operating and alarms status. The system includes:
  - Voltage free contact for remote general alarm.
  - Main components hour-meter.
  - Non-volatile "Flash" memory for data storage.
  - Menu with protection password.
  - LAN connection.

#### HYDRAULIC CONNECTIONS OF HEAT EXCHANGERS

- The heat exchangers' threaded hydraulic connections are available up to a diameter of 3 " included, and correspond to ISO 228/1 – G M.
- The pipes' threaded hydraulic connections are available up to a diameter of 3 " included, and correspond to ISO 7/1 – R.
- The hydraulic connections with flange (FL) are supplied as standard with counter flange.
- The hydraulic connections with grooved end (Victaulic) are supplied as standard with Victaulic joint and adapter pipe.

## OPTIONAL ACCESSORIES

The descriptions of these additional components can be found in Chapter OPTIONAL ACCESSORIES.

- Hydronic group with 1 pump.
- Hydronic group with 2 pump.
- LNO Kit for a reduction of the machine noise emission.
- ELN Kit for an extreme reduction of the machine noise emission.
- Axial fans equipped with EC electric motor.
- Partial heat recovery system
- Total heat recovery system.

### OTHER OPTIONAL ACCESSORIES

- BRINE kit for chilled water production up to  $-12^{\circ}\text{C}$ .

#### **WARNING**

**With BRINE Kit it is mandatory to use antifreeze mixture.** Refer to the paragraph ANTIFREEZE SOLUTION.

The use of antifreeze mixtures causes a reduction of the machine performance, Please refer to the RC WORLD electronic catalogue to obtain the effective performance.

- Condensing coil protection net.
- Condensing coil in special execution (please contact the RC GROUP Commercial Dept.).
- Spring antivibrating supports - not installed.
- Rubber supports - not installed.
- Power factor capacitor for motor compressor -  $\cos\phi 0,9$ .
- Ambient temperature sensor. The ambient temperature sensor requires the installation of "Additional module" and "Driver for additional module" optional accessories.
- MP.COM microprocessor control accessories:
  - Remote terminal.
  - Clock card for alarms date and time displaying and storing.
  - Serial port RCcom, MBUS/JBUS.
  - Serial port LON.
  - Serial port BACnet for Ethernet – SNMP – TCP/IP.
  - Serial port BACnet for MS/TP.
  - Serial port for GSM modem.
  - Data logger for the memorization of the intervened alarms.
  - Additional module with the following inlets / outlets:
    - INLETS
      - External alarm 1
      - External alarm 2
      - Line current indication.
      - Line voltage indication / Compensation
      - Ambient air temperature
    - OUTLETS
      - External alarm 1
      - External alarm 2
      - General alarm 2
      - General alarm 3
  - Driver for the additional module.

#### **WARNING**

**It is mandatory to install a water filter on evaporator water inlet.**

RC GROUP reserves the right to accept the matching of the optional installed on the unit.

## TECHNICAL DATA

MODEL		T 40 P2 S	T 40 P2 D	T 48 P2 S	T 48 P2 D	T 54 P2 S	T 54 P2 D
SIZE		U5	U5	U5	U5	U5	U5
<b>COOLING ONLY (1)</b>							
<b>COOLING CAPACITY</b>	<b>kW</b>	<b>42,1</b>	<b>41,8</b>	<b>48,8</b>	<b>48,7</b>	<b>56,0</b>	<b>55,6</b>
Compressors power input	kW	13,2	13,9	16,5	16,5	19,3	19,3
Compressors operating current [OA]	A	26,5	27,3	30,9	30,9	34,3	34,4
Evaporator water flow rate	m <sup>3</sup> /h	7,2	7,2	8,4	8,4	9,6	9,6
Evaporator pressure drop	kPa	41	23	38	22	39	21
<b>COOLING + TOTAL HEAT RECOVERY (2)</b>							
<b>COOLING CAPACITY</b>	<b>kW</b>	<b>40,3</b>	<b>41,0</b>	<b>47,6</b>	<b>48,3</b>	<b>55,6</b>	<b>56,3</b>
<b>HEATING CAPACITY</b>	<b>kW</b>	<b>54,5</b>	<b>54,9</b>	<b>64,0</b>	<b>64,4</b>	<b>74,2</b>	<b>74,5</b>
Compressors power input	kW	14,2	13,9	16,5	16,1	18,7	18,2
Compressors operating current [OA]	A	26,4	26,0	30,6	30,1	33,4	32,7
Heat recovery water flow rate	m <sup>3</sup> /h	9,5	9,6	11,1	11,2	12,9	12,9
Heat recovery pressure drop	kPa	52	35	52	34	54	33
<b>PARTIAL HEAT RECOVERY (3)</b>							
<b>HEATING CAPACITY</b>	<b>kW</b>	<b>15,5</b>	--	<b>17,9</b>	--	<b>20,6</b>	--
Heat recovery water flow rate	m <sup>3</sup> /h	2,7	--	3,1	--	3,5	--
Heat recovery pressure drop	kPa	28,4	--	38,0	--	32,6	--
<b>COMPRESSORS</b>							
Quantity	n.	scroll	scroll	scroll	scroll	scroll	scroll
Maximum current	A	42	42	44	44	50	50
Starting current	A	132	132	140	140	143	143
Capacity steps	n.	2	2	2	2	2	2
<b>EVAPORATOR</b>							
Quantity	n.	1	1	1	1	1	1
Water volume	l	3,1	3,6	3,1	4,2	3,9	4,2
Max water flow rate	m <sup>3</sup> /h	10,1	10,1	11,7	11,7	13,5	13,4
<b>TOTAL HEAT RECOVERY EXCHANGER</b>							
Quantity	n.	1	1	1	1	1	1
Water volume	l	3,1	3,6	3,1	4,2	3,9	4,2
Max water flow rate	m <sup>3</sup> /h	13,3	13,4	15,5	15,7	18,1	18,1
<b>PARTIAL HEAT RECOVERY EXCHANGER</b>							
Quantity	n.	1	--	1	--	1	--
Water volume	l	0,6	--	0,6	--	0,8	--
Max water flow rate	m <sup>3</sup> /h	3,7	--	4,3	--	5,0	--
<b>AXIAL FANS</b>							
Quantity	n.	4	4	4	4	4	4
Total air flow	m <sup>3</sup> /h	21600	21600	20400	20400	19200	19200
Power input	kW	0,6	0,6	1,1	1,1	1,1	1,1
Plate current [FLA]	A	2,5	2,5	4,7	4,7	4,7	4,7
<b>REFRIGERANT</b>							
Total refrigerant charge (optional excluded)	kg	R410A 9,9	R410A 10,3	R410A 9,9	R410A 10,6	R410A 10,8	R410A 10,6
Gas circuits	n.	1	2	1	2	1	2
<b>POWER SUPPLY</b>	V/Ph/H	400/3/50+N	400/3/50+N	400/3/50+N	400/3/50+N	400/3/50+N	400/3/50+N
<b>ENERGY EFFICIENCY INDEXES</b>							
EER - Energy Efficiency Ratio	kW/kW	3,05	2,88	2,77	2,77	2,75	2,73
ESEER = Eurovent Standard		4,39	3,99	4,37	3,90	4,48	3,92
IPLV = ARI Standard 550/590		4,87	4,42	4,84	4,33	4,97	4,35
<b>SOUND LEVEL</b>							
Sound pressure level [Lp] (4)	dB(A)	65,0	65,0	65,0	65,0	65,0	65,0
Sound power level [Lw] (5)	dB(A)	82,0	82,0	82,0	82,0	82,1	82,1
<b>HYDRONIC GROUP</b>							
With 1 pump – 2 poles motor		HYG 150/1	HYG 150/1	HYG 150/1	HYG 150/1	HYG 150/1	HYG 150/1
With 2 pumps – 2 poles motor		HYG 150/2	HYG 150/2	HYG 150/2	HYG 150/2	HYG 150/2	HYG 150/2
With 1 pump – 4 poles motor		--	--	--	--	--	--
With 2 pumps – 4 poles motor		--	--	--	--	--	--
Water tank volume	l	150	150	150	150	150	150
<b>DIMENSIONS</b>							
Length	mm	2000	2000	2000	2000	2000	2000
Width	mm	1200	1200	1200	1200	1200	1200
Height	mm	1630	1630	1630	1630	1630	1630
<b>NET WEIGHT</b>	kg	660	670	690	700	720	730
<b>HYDRAULIC CONNECTIONS</b>							
<b>EVAPORATOR</b>							
Inlet / Outlet – ISO 7/1 R	Ø	2"	2"	2"	2"	2"	2"
Inlet / Outlet – Victaulic - OD	Ø mm	--	--	--	--	--	--
<b>PARTIAL HEAT RECOVERY</b>							
Inlet / Outlet – ISO 7/1 R	Ø	1 1/2"	--	1 1/2"	--	1 1/2"	--
<b>TOTAL HEAT RECOVERY</b>							
Inlet / Outlet – ISO 7/1 R	Ø	2"	2"	2"	2"	2"	2"
Inlet / Outlet – Victaulic - OD	Ø mm	--	--	--	--	--	--

1. Referred to chiller water temperature 12/7°C; 35°C ambient temperature.
2. Referred to chiller water temperature 12/7°C and hot water temperature 40/45°C.
3. Referred to chiller water temperature 12/7°C; 35°C ambient temperature and hot water temperature 40/45°C.
4. Sound pressure level [Lp] 1m far according to ISO EN 3744
5. Sound power level [Lw] according to ISO EN 9614 - 2

## TECHNICAL DATA

MODEL		T.60.P.2 S	T.60.P.2 D	T.70.P.2 S	T.70.P.2 D	T.90.P.2 S	T.90.P.2 D
SIZE		U6	U6	U6	U6	U7	U7
<b>COOLING ONLY (1)</b>							
<b>COOLING CAPACITY</b>	<b>kW</b>	<b>63,0</b>	<b>62,6</b>	<b>72,5</b>	<b>72,7</b>	<b>93,6</b>	<b>93,6</b>
Compressors power input	kW	20,2	20,2	24,5	24,6	31,0	31,0
Compressors operating current [OA]	A	36,5	36,6	47,8	49,3	54,9	54,8
Evaporator water flow rate	m <sup>3</sup> /h	10,8	10,8	12,5	12,5	16,1	16,1
Evaporator pressure drop	kPa	36	23	41	23	38	24
<b>COOLING + TOTAL HEAT RECOVERY (2)</b>							
<b>COOLING CAPACITY</b>	<b>kW</b>	<b>63,3</b>	<b>62,0</b>	<b>71,6</b>	<b>73,1</b>	<b>90,8</b>	<b>92,0</b>
<b>HEATING CAPACITY</b>	<b>kW</b>	<b>83,2</b>	<b>82,5</b>	<b>95,9</b>	<b>96,9</b>	<b>122,0</b>	<b>123,0</b>
Compressors power input	kW	19,9	20,5	24,4	23,8	31,5	30,9
Compressors operating current [OA]	A	36,7	37,5	46,6	45,8	55,4	54,5
Heat recovery water flow rate	m <sup>3</sup> /h	14,5	14,3	16,7	16,8	21,3	21,4
Heat recovery pressure drop	kPa	17	33	55	34	47	32
<b>PARTIAL HEAT RECOVERY (3)</b>							
<b>HEATING CAPACITY</b>	<b>kW</b>	<b>23,1</b>	--	<b>26,6</b>	--	<b>34,4</b>	--
Heat recovery water flow rate	m <sup>3</sup> /h	4,0	--	4,6	--	5,9	--
Heat recovery pressure drop	kPa	41,2	--	32,0	--	31,2	--
<b>COMPRESSORS</b>							
		scroll	scroll	scroll	scroll	scroll	scroll
Quantity	n.	2	2	2	2	2	2
Maximum current	A	62	62	68	68	80	80
Starting current	A	171	171	207	207	265	265
Capacity steps	n.	2	2	2	2	2	2
<b>EVAPORATOR</b>							
		1	1	1	1	1	1
Water volume	l	3,9	4,2	4,7	6,4	5,8	6,7
Max water flow rate	m <sup>3</sup> /h	15,1	15,1	17,5	17,5	22,5	22,5
<b>TOTAL HEAT RECOVERY EXCHANGER</b>							
		1	1	1	1	1	1
Water volume	l	3,9	4,2	4,7	6,4	5,8	6,7
Max water flow rate	m <sup>3</sup> /h	20,3	20,0	23,4	23,5	29,8	30,0
<b>PARTIAL HEAT RECOVERY EXCHANGER</b>							
		1	--	1	--	1	--
Water volume	l	0,8	--	1,0	--	2,0	--
Max water flow rate	m <sup>3</sup> /h	5,6	--	6,4	--	8,3	--
<b>AXIAL FANS</b>							
		6	6	6	6	2	2
Total air flow	m <sup>3</sup> /h	32400	32400	30600	30600	46400	46400
Power input	kW	0,8	0,8	1,6	1,6	3,9	3,9
Plate current [FLA]	A	3,7	3,7	7,1	7,1	7,8	7,8
<b>REFRIGERANT</b>							
Total refrigerant charge (optional excluded)	kg	R410A 14,9	R410A 14,7	R410A 15,3	R410A 15,6	R410A 22,3	R410A 23,4
Gas circuits	n.	1	2	1	2	1	2
<b>POWER SUPPLY</b>							
	V/Ph/H	400/3/50+N	400/3/50+N	400/3/50+N	400/3/50+N	400/3/50	400/3/50
<b>ENERGY EFFICIENCY INDEXES</b>							
EER - Energy Efficiency Ratio	kW/kW	3,00	2,98	2,78	2,77	2,68	2,68
ESEER = Eurovent Standard		4,26	3,85	4,32	4,00	3,84	3,53
IPLV = ARI Standard 550/590		4,72	4,27	4,79	4,44	4,26	3,91
<b>SOUND LEVEL</b>							
Sound pressure level [Lp] (4)	dB(A)	66,3	66,3	66,4	66,4	74,2	74,2
Sound power level [Lw] (5)	dB(A)	83,3	83,3	83,8	83,8	92,3	92,3
<b>HYDRONIC GROUP</b>							
With 1 pump – 2 poles motor		HYG 240/1	HYG 240/1	HYG 240/1	HYG 240/1	HYG 360/1	HYG 360/1
With 2 pumps – 2 poles motor		HYG 240/2	HYG 240/2	HYG 240/2	HYG 240/2	HYG 360/2	HYG 360/2
With 1 pump – 4 poles motor		--	--	--	--	--	--
With 2 pumps – 4 poles motor		--	--	--	--	--	--
Water tank volume	l	240	240	240	240	360	360
<b>DIMENSIONS</b>							
Length	mm	2580	2580	2580	2580	3020	3020
Width	mm	1200	1200	1200	1200	1200	1200
Height	mm	1630	1630	1630	1630	1950	1950
<b>NET WEIGHT</b>	kg	810	830	850	870	1150	1170
<b>HYDRAULIC CONNECTIONS</b>							
<b>EVAPORATOR</b>							
Inlet / Outlet – ISO 7/1 R	Ø	2"	2"	2"	2"	--	--
Inlet / Outlet – Victaulic - OD	Ø mm	--	--	--	--	73	73
<b>PARTIAL HEAT RECOVERY</b>							
Inlet / Outlet – ISO 7/1 R	Ø	1 1/2"	--	1 1/2"	--	1 1/2"	--
<b>TOTAL HEAT RECOVERY</b>							
Inlet / Outlet – ISO 7/1 R	Ø	2"	2"	2"	2"	--	--
Inlet / Outlet – Victaulic - OD	Ø mm	--	--	--	--	73	73

1. Referred to chiller water temperature 12/7°C; 35°C ambient temperature.
2. Referred to chiller water temperature 12/7°C and hot water temperature 40/45°C.
3. Referred to chiller water temperature 12/7°C; 35°C ambient temperature and hot water temperature 40/45°C.
4. Sound pressure level [Lp] 1m far according to ISO EN 3744
5. Sound power level [Lw] according to ISO EN 9614 – 2

## TECHNICAL DATA

MODEL		T.120.P.2	T.120.P.2	T.150.P2	T.150.P2	T.170.P4	T.175.P3
		S	D	S	D	D	S
SIZE		U7	U7	U8L	U8L	U8L	U8L
<b>COOLING ONLY (1)</b>							
<b>COOLING CAPACITY</b>	<b>kW</b>	<b>115,0</b>	<b>114,0</b>	<b>151,0</b>	<b>152,0</b>	<b>167,0</b>	<b>176,0</b>
Compressors power input	kW	40,2	40,1	50,9	51,2	58,0	57,7
Compressors operating current [OA]	A	69,7	69,7	87,6	88,2	107,0	101,0
Evaporator water flow rate	m <sup>3</sup> /h	19,8	19,6	25,9	26,2	28,8	30,3
Evaporator pressure drop	kPa	39	31	38	34	33	44
<b>COOLING + TOTAL HEAT RECOVERY (2)</b>							
<b>COOLING CAPACITY</b>	<b>kW</b>	<b>114,0</b>	<b>113,0</b>	<b>150,0</b>	<b>149,0</b>	<b>162,0</b>	<b>172,0</b>
<b>HEATING CAPACITY</b>	<b>kW</b>	<b>154,0</b>	<b>153,0</b>	<b>201,0</b>	<b>199,0</b>	<b>212,0</b>	<b>232,0</b>
Compressors power input	kW	39,9	39,3	50,7	50,3	50,0	59,8
Compressors operating current [OA]	A	69,1	68,5	87,3	86,7	86,3	104,0
Heat recovery water flow rate	m <sup>3</sup> /h	26,7	26,5	35,0	34,7	36,8	40,4
Heat recovery pressure drop	kPa	47	43	40	43	54	46
<b>PARTIAL HEAT RECOVERY (3)</b>							
<b>HEATING CAPACITY</b>	<b>kW</b>	<b>42,3</b>	<b>--</b>	<b>55,3</b>	<b>55,9</b>	<b>61,4</b>	<b>64,7</b>
Heat recovery water flow rate	m <sup>3</sup> /h	7,3	--	9,5	9,6	10,6	11,1
Heat recovery pressure drop	kPa	33,0	--	43,2	34,9	42,1	34,7
<b>COMPRESSORS</b>							
		scroll	scroll	scroll	scroll	scroll	scroll
Quantity	n.	2	2	2	2	4	3
Maximum current	A	97	97	131	131	148	146
Starting current	A	321	321	375	375	333	369
Capacity steps	n.	2	2	2	2	4	3
<b>EVAPORATOR</b>							
	n.	1	1	1	1	1	1
Water volume	l	7,2	8,3	8,7	12,3	12,3	11,1
Max water flow rate	m <sup>3</sup> /h	27,7	27,4	36,3	36,7	40,3	42,4
<b>TOTAL HEAT RECOVERY EXCHANGER</b>							
	n.	1	1	1	1	1	1
Water volume	l	7,2	8,3	8,7	12,3	12,3	11,1
Max water flow rate	m <sup>3</sup> /h	37,4	37,1	49,0	48,6	51,5	56,6
<b>PARTIAL HEAT RECOVERY EXCHANGER</b>							
	n.	1	--	1	2	2	2
Water volume	l	2,0	--	4,0	2,0	3,4	5,3
Max water flow rate	m <sup>3</sup> /h	10,2	--	13,3	13,5	14,8	15,5
<b>AXIAL FANS</b>							
	n.	2	2	3	3	3	4
Total air flow	m <sup>3</sup> /h	46400	46400	69600	69600	69600	88000
Power input	kW	3,9	3,9	5,8	5,8	5,8	7,8
Plate current [FLA]	A	7,8	7,8	11,7	11,7	11,7	15,6
<b>REFRIGERANT</b>							
		R410A	R410A	R410A	R410A	R410A	R410A
Total refrigerant charge (optional excluded)	kg	23,3	24,7	32,8	34,9	35,7	34,8
Gas circuits	n.	1	2	1	2	2	1
<b>POWER SUPPLY</b>							
	V/Ph/H	400/3/50	400/3/50	400/3/50	400/3/50	400/3/50	400/3/50
<b>ENERGY EFFICIENCY INDEXES</b>							
EER - Energy Efficiency Ratio	kW/kW	2,61	2,59	2,66	2,67	2,62	2,69
ESEER = Eurovent Standard		4,00	3,59	3,93	3,54	3,58	4,05
IPLV = ARI Standard 550/590		4,43	3,98	4,36	3,93	4,62	4,50
<b>SOUND LEVEL</b>							
Sound pressure level [Lp] (4)	dB(A)	74,4	74,4	76,0	76,0	76,0	75,5
Sound power level [Lw] (5)	dB(A)	92,5	92,5	95,4	95,4	95,4	94,9
<b>HYDRONIC GROUP</b>							
With 1 pump – 2 poles motor		HYG 360/1	HYG 360/1	HAL01U8A	HAL01U8A	HAL01U8A	HAL01U8A
With 2 pumps – 2 poles motor		HYG 360/2	HYG 360/2	HAL02U8A	HAL02U8A	HAL02U8A	HAL02U8A
With 1 pump – 4 poles motor		--	--	--	--	--	--
With 2 pumps – 4 poles motor		--	--	--	--	--	--
Water tank volume	l	360	360	500	500	500	500
<b>DIMENSIONS</b>							
Length	mm	3020	3020	3600	3600	3600	3600
Width	mm	1200	1200	2250	2250	2250	2250
Height	mm	1950	1950	2290	2290	2290	2290
<b>NET WEIGHT</b>							
	kg	1270	1280	1495	1495	1595	1660
<b>HYDRAULIC CONNECTIONS</b>							
<b>EVAPORATOR</b>							
Inlet / Outlet – ISO 7/1 R	Ø	--	--	--	--	--	--
Inlet / Outlet – Victaulic - OD	Ø mm	73	73	88,9	88,9	88,9	88,9
<b>PARTIAL HEAT RECOVERY</b>							
Inlet / Outlet – ISO 7/1 R	Ø	1 1/2"	--	2"	2"	2"	2"
<b>TOTAL HEAT RECOVERY</b>							
Inlet / Outlet – ISO 7/1 R	Ø	--	--	--	--	--	--
Inlet / Outlet – Victaulic - OD	Ø mm	73	73	88,9	88,9	88,9	88,9

1. Referred to chiller water temperature 12/7°C; 35°C ambient temperature.
2. Referred to chiller water temperature 12/7°C and hot water temperature 40/45°C.
3. Referred to chiller water temperature 12/7°C; 35°C ambient temperature and hot water temperature 40/45°C.
4. Sound pressure level [Lp] 1m far according to ISO EN 3744
5. Sound power level [Lw] according to ISO EN 9614 - 2

## TECHNICAL DATA

MODEL		T.190.P4 D	T.200.P2 S	T.200.P2 D	T.220.P3 S	T.290.P3 S
SIZE		U8L	U8L	U8L	U8L	U9L
<b>COOLING ONLY (1)</b>						
<b>COOLING CAPACITY</b>	<b>kW</b>	<b>195,0</b>	<b>198,0</b>	<b>198,0</b>	<b>229,0</b>	<b>289,0</b>
Compressors power input	kW	62,7	63,9	64,2	79,2	95,4
Compressors operating current [OA]	A	111,0	111,0	111,0	136,0	165,0
Evaporator water flow rate	m <sup>3</sup> /h	33,5	34,1	33,9	39,4	49,6
Evaporator pressure drop	kPa	27	37	42	40	40
<b>COOLING + TOTAL HEAT RECOVERY (2)</b>						
<b>COOLING CAPACITY</b>	<b>kW</b>	<b>199,0</b>	<b>194,0</b>	<b>196,0</b>	<b>232,0</b>	<b>290,0</b>
<b>HEATING CAPACITY</b>	<b>kW</b>	<b>261,0</b>	<b>258,0</b>	<b>259,0</b>	<b>308,0</b>	<b>385,0</b>
Compressors power input	kW	62,0	63,4	63,3	75,3	95,0
Compressors operating current [OA]	A	109,0	110,0	110,0	130,0	165,0
Heat recovery water flow rate	m <sup>3</sup> /h	45,3	44,8	45,0	53,5	66,9
Heat recovery pressure drop	kPa	38	55	63	62	67
<b>PARTIAL HEAT RECOVERY (3)</b>						
<b>HEATING CAPACITY</b>	<b>kW</b>	<b>71,6</b>	<b>72,8</b>	<b>72,5</b>	<b>84,0</b>	<b>106,0</b>
Heat recovery water flow rate	m <sup>3</sup> /h	12,3	12,5	12,5	14,5	18,3
Heat recovery pressure drop	kPa	33,9	44,0	34,7	41,8	39,7
<b>COMPRESSORS</b>						
		scroll	scroll	scroll	scroll	scroll
Quantity	n.	4	2	2	3	3
Maximum current	A	160	164	164	197	246
Starting current	A	345	466	466	441	584
Capacity steps	n.	4	2	2	3	3
<b>EVAPORATOR</b>						
	n.	1	1	1	1	1
Water volume	l	20,3	20,7	20,3	20,7	27,0
Max water flow rate	m <sup>3</sup> /h	46,9	47,7	47,5	55,2	69,4
<b>TOTAL HEAT RECOVERY EXCHANGER</b>						
	n.	1	1	1	1	1
Water volume	l	20,3	20,7	20,3	20,7	27,0
Max water flow rate	m <sup>3</sup> /h	63,4	62,7	63,0	74,9	93,7
<b>PARTIAL HEAT RECOVERY EXCHANGER</b>						
	n.	2	1	2	1	1
Water volume	l	3,4	5,3	4,0	6,3	8,0
Max water flow rate	m <sup>3</sup> /h	17,2	17,5	17,5	20,3	25,6
<b>AXIAL FANS</b>						
	n.	4	4	4	4	6
Total air flow	m <sup>3</sup> /h	88000	88000	88000	88000	126000
Power input	kW	7,8	7,8	7,8	7,8	11,6
Plate current [FLA]	A	15,6	15,6	15,6	15,6	23,4
<b>REFRIGERANT</b>						
Total refrigerant charge (optional excluded)	kg	R410A 38,5	R410A 37,6	R410A 37,5	R410A 37,4	R410A 51,7
Gas circuits	n.	2	1	2	1	1
<b>POWER SUPPLY</b>						
	V/Ph/Hz	400/3/50	400/3/50	400/3/50	400/3/50	400/3/50
<b>ENERGY EFFICIENCY INDEXES</b>						
EER - Energy Efficiency Ratio	kW/kW	2,77	2,76	2,75	2,63	2,70
ESEER = Eurovent Standard		3,64	3,95	3,62	4,23	4,19
IPLV = ARI Standard 550/590		4,96	4,38	4,01	4,70	4,65
<b>SOUND LEVEL</b>						
Sound pressure level [Lp] (4)	dB(A)	75,4	75,4	75,4	75,3	76,5
Sound power level [Lw] (5)	dB(A)	94,8	94,8	94,8	94,7	96,4
<b>HYDRONIC GROUP</b>						
With 1 pump – 2 poles motor		HAL01U8A	HAL01U8A	HAL01U8A	HAL01U8B	HAL01U9A
With 2 pumps – 2 poles motor		HAL02U8A	HAL02U8A	HAL02U8A	HAL02U8B	HAL02U9A
With 1 pump – 4 poles motor		--	--	--	--	--
With 2 pumps – 4 poles motor		--	--	--	--	--
Water tank volume	l	500	500	500	500	700
<b>DIMENSIONS</b>						
Length	mm	3600	3600	3600	3600	4600
Width	mm	2250	2250	2250	2250	2250
Height	mm	2290	2290	2290	2290	2290
<b>NET WEIGHT</b>	kg	1840	1640	1640	1835	2140
<b>HYDRAULIC CONNECTIONS</b>						
<b>EVAPORATOR</b>						
Inlet / Outlet – ISO 7/1 R	Ø	--	--	--	--	--
Inlet / Outlet – Victaulic - OD	Ø mm	88,9	88,9	88,9	88,9	88,9
<b>PARTIAL HEAT RECOVERY</b>						
Inlet / Outlet – ISO 7/1 R	Ø	2"	2"	2"	2"	2"
<b>TOTAL HEAT RECOVERY</b>						
Inlet / Outlet – ISO 7/1 R	Ø	--	--	--	--	--
Inlet / Outlet – Victaulic - OD	Ø mm	88,9	88,9	88,9	88,9	88,9

1. Referred to chiller water temperature 12/7°C; 35°C ambient temperature.
2. Referred to chiller water temperature 12/7°C and hot water temperature 40/45°C.
3. Referred to chiller water temperature 12/7°C; 35°C ambient temperature and hot water temperature 40/45°C.
4. Sound pressure level [Lp] 1m far according to ISO EN 3744
5. Sound power level [Lw] according to ISO EN 9614 – 2

## TECHNICAL DATA

MODEL		T.240.P4 D	T.300.P.4 D	T.340.P4 D
SIZE		Y2	Y2	Y2
<b>COOLING ONLY (1)</b>				
<b>COOLING CAPACITY</b>	<b>kW</b>	<b>242,0</b>	<b>302,0</b>	<b>344,0</b>
Compressors power input	kW	78,0	101,0	118,0
Compressors operating current [OA]	A	136,0	174,0	202,0
Evaporator water flow rate	m <sup>3</sup> /h	41,6	52,0	59,2
Evaporator pressure drop	kPa	50	56	54
<b>COOLING + TOTAL HEAT RECOVERY (2)</b>				
<b>COOLING CAPACITY</b>	<b>kW</b>	<b>237,0</b>	<b>297,0</b>	<b>345,0</b>
<b>HEATING CAPACITY</b>	<b>kW</b>	<b>315,0</b>	<b>398,0</b>	<b>459,0</b>
Compressors power input	kW	78,5	100,0	114,0
Compressors operating current [OA]	A	137,0	173,0	197,0
Heat recovery water flow rate	m <sup>3</sup> /h	54,8	69,1	79,8
Heat recovery pressure drop	kPa	74	81	78
<b>PARTIAL HEAT RECOVERY (3)</b>				
<b>HEATING CAPACITY</b>	<b>kW</b>	<b>88,9</b>	<b>111,0</b>	<b>126,0</b>
Heat recovery water flow rate	m <sup>3</sup> /h	15,3	19,1	21,8
Heat recovery pressure drop	kPa	36,0	43,5	56,3
<b>COMPRESSORS</b>				
		scroll	scroll	scroll
Quantity	n.	4	4	4
Maximum current	A	194	262	295
Starting current	A	418	507	597
Capacity steps	n.	4	4	4
<b>EVAPORATOR</b>				
		1	1	1
Water volume	l	20,3	27,5	33,8
Max water flow rate	m <sup>3</sup> /h	58,2	72,8	82,9
<b>TOTAL HEAT RECOVERY EXCHANGER</b>				
		1	1	1
Water volume	l	20,3	27,5	33,8
Max water flow rate	m <sup>3</sup> /h	76,2	96,7	111,7
<b>PARTIAL HEAT RECOVERY EXCHANGER</b>				
		2	2	2
Water volume	l	4,0	8,0	8,0
Max water flow rate	m <sup>3</sup> /h	21,4	26,7	30,5
<b>AXIAL FANS</b>				
		6	6	6
Total air flow	m <sup>3</sup> /h	132000	126000	126000
Power input	kW	11,6	11,6	11,6
Plate current [FLA]	A	23,4	23,4	23,4
<b>REFRIGERANT</b>				
Total refrigerant charge (optional excluded)	kg	R410A 51,3	R410A 54,3	R410A 55,4
Gas circuits	n.	2	2	2
<b>POWER SUPPLY</b>				
	V/Ph/Hz	400/3/50	400/3/50	400/3/50
<b>ENERGY EFFICIENCY INDEXES</b>				
EER - Energy Efficiency Ratio	kW/kW	2,70	2,68	2,65
ESEER = Eurovent Standard		3,46	3,56	3,60
IPLV = ARI Standard 550/590		3,84	3,95	3,99
<b>SOUND LEVEL</b>				
Sound pressure level [Lp] (4)	dB(A)	80,2	80,2	80,8
Sound power level [Lw] (5)	dB(A)	100,0	100,0	100,6
<b>HYDRONIC GROUP</b>				
With 1 pump – 2 poles motor		HAL01Y2A	HAL01Y2B	HAL01Y2C
With 2 pumps – 2 poles motor		HAL02Y2A	HAL02Y2B	HAL02Y2C
With 1 pump – 4 poles motor		HAL01Y2A_LN	HAL01Y2A_LN	HAL01Y2B_LN
With 2 pumps – 4 poles motor		HAL02Y2A_LN	HAL02Y2A_LN	HAL02Y2B_LN
Water tank volume	l	500	500	500
<b>DIMENSIONS</b>				
Length	mm	4079	4079	4079
Width	mm	2310	2310	2310
Height	mm	2490	2490	2490
<b>NET WEIGHT</b>	kg	2730	2750	2790
<b>HYDRAULIC CONNECTIONS</b>				
<b>EVAPORATOR</b>				
Inlet / Outlet – Victaulic - OD	Ø mm	114,3	114,3	114,3
<b>PARTIAL HEAT RECOVERY</b>				
Inlet / Outlet – ISO228/1-G M	Ø	2 x 2"	2 x 2"	2 x 2"
<b>TOTAL HEAT RECOVERY</b>				
Inlet / Outlet – Victaulic - OD	Ø mm	114,3	114,3	114,3

1. Referred to chiller water temperature 12/7°C; 35°C ambient temperature.
2. Referred to chiller water temperature 12/7°C and hot water temperature 40/45°C.
3. Referred to chiller water temperature 12/7°C; 35°C ambient temperature and hot water temperature 40/45°C.
4. Sound pressure level [Lp] 1m far according to ISO EN 3744
5. Sound power level [Lw] according to ISO EN 9614 - 2

## TECHNICAL DATA

MODEL		T.380.P4 D	T.460.P.6 D	T.570.P6 D
SIZE		Y3	Y3	Y4
<b>COOLING ONLY (1)</b>				
<b>COOLING CAPACITY</b>	<b>kW</b>	<b>382,0</b>	<b>456,0</b>	<b>574,0</b>
Compressors power input	kW	127,0	155,0	196,0
Compressors operating current [OA]	A	222,0	266,0	337,0
Evaporator water flow rate	m <sup>3</sup> /h	65,7	78,5	98,7
Evaporator pressure drop	kPa	52	49	67
<b>COOLING + TOTAL HEAT RECOVERY (2)</b>				
<b>COOLING CAPACITY</b>	<b>kW</b>	<b>378,0</b>	<b>459,0</b>	<b>569,0</b>
<b>HEATING CAPACITY</b>	<b>kW</b>	<b>505,0</b>	<b>609,0</b>	<b>760,0</b>
Compressors power input	kW	127,0	150,0	191,0
Compressors operating current [OA]	A	220,0	258,0	331,0
Heat recovery water flow rate	m <sup>3</sup> /h	87,8	106,0	132,0
Heat recovery pressure drop	kPa	67	58	75
<b>PARTIAL HEAT RECOVERY (3)</b>				
<b>HEATING CAPACITY</b>	<b>kW</b>	<b>140,0</b>	<b>168,0</b>	<b>211,0</b>
Heat recovery water flow rate	m <sup>3</sup> /h	24,2	28,9	36,3
Heat recovery pressure drop	kPa	40,9	41,7	41,3
<b>COMPRESSORS</b>				
		scroll	scroll	scroll
Quantity	n.	4	6	6
Maximum current	A	328	393	492
Starting current	A	630	637	794
Capacity steps	n.	4	6	6
<b>EVAPORATOR</b>				
		1	1	1
Water volume	l	44,6	44,6	57,2
Max water flow rate	m <sup>3</sup> /h	92,0	109,9	138,2
<b>TOTAL HEAT RECOVERY EXCHANGER</b>				
		1	1	1
Water volume	l	44,6	44,6	57,2
Max water flow rate	m <sup>3</sup> /h	122,9	148,4	184,8
<b>PARTIAL HEAT RECOVERY EXCHANGER</b>				
		2	2	2
Water volume	l	10,6	12,6	16,0
Max water flow rate	m <sup>3</sup> /h	33,9	40,5	50,8
<b>AXIAL FANS</b>				
		8	8	10
Total air flow	m <sup>3</sup> /h	176000	171600	214500
Power input	kW	15,5	15,5	19,4
Plate current [FLA]	A	31,2	31,2	39,0
<b>REFRIGERANT</b>				
Total refrigerant charge (optional excluded)	kg	R410A 89,4	R410A 90,7	R410A 140,6
Gas circuits	n.	2	2	2
<b>POWER SUPPLY</b>				
	V/Ph/Hz	400/3/50	400/3/50	400/3/50
<b>ENERGY EFFICIENCY INDEXES</b>				
EER - Energy Efficiency Ratio	kW/kW	2,68	2,67	2,66
ESEER = Eurovent Standard		3,56	3,86	3,76
IPLV = ARI Standard 550/590		3,95	4,28	4,17
<b>SOUND LEVEL</b>				
Sound pressure level [Lp] (4)	dB(A)	80,4	81,5	82,3
Sound power level [Lw] (5)	dB(A)	100,7	101,8	103,1
<b>HYDRONIC GROUP</b>				
With 1 pump – 2 poles motor		HAL01Y3A	HAL01Y3A	HAL01Y4A
With 2 pumps – 2 poles motor		HAL02Y3A	HAL02Y3A	HAL02Y4A
With 1 pump – 4 poles motor		HAL01Y3A_LN	HAL01Y3A_LN	HAL01Y4A_LN
With 2 pumps – 4 poles motor		HAL02Y3A_LN	HAL02Y3A_LN	HAL02Y4A_LN
Water tank volume	l	800	800	800
<b>DIMENSIONS</b>				
Length	mm	5233	5233	6377
Width	mm	2310	2310	2310
Height	mm	2490	2490	2490
<b>NET WEIGHT</b>				
	kg	3290	3780	4470
<b>HYDRAULIC CONNECTIONS</b>				
<b>EVAPORATOR</b>				
Inlet / Outlet – Victaulic - OD	Ø mm	114,3	114,3	114,3
<b>PARTIAL HEAT RECOVERY</b>				
Inlet / Outlet – ISO228/1-G M	Ø	2 x 2"	2 x 2"	2 x 2"
<b>TOTAL HEAT RECOVERY</b>				
Inlet / Outlet – Victaulic - OD	Ø mm	114,3	114,3	114,3

1. Referred to chiller water temperature 12/7°C; 35°C ambient temperature.
2. Referred to chiller water temperature 12/7°C and hot water temperature 40/45°C.
3. Referred to chiller water temperature 12/7°C; 35°C ambient temperature and hot water temperature 40/45°C.
4. Sound pressure level [Lp] 1m far according to ISO EN 3744
5. Sound power level [Lw] according to ISO EN 9614 – 2

## ACOUSTIC DATA

MODEL		T 40 P2 S	T 40 P2 D	T 48 P2 S	T 48 P2 D	T 54 P2 S	T 54 P2 D
<b>SIZE</b>		<b>U5</b>	<b>U5</b>	<b>U5</b>	<b>U5</b>	<b>U5</b>	<b>U5</b>
Sound power level [Lw] (1)	dB(A)	82,0	82,0	82,0	82,0	82,1	82,1
Sound pressure level at 1m [Lp] (2)	dB(A)	65,0	65,0	65,0	65,0	65,0	65,0
Sound pressure level at 5m [Lp] (3)	dB(A)	55,6	55,6	55,6	55,6	55,6	55,6
Sound pressure level at 10m [Lp] (3)	dB(A)	50,4	50,4	50,4	50,4	50,4	50,4

MODEL		T 60 P2 S	T 60 P2 D	T 70 P2 S	T 70 P2 D	T 90 P2 S	T 90 P2 D
<b>SIZE</b>		<b>U6</b>	<b>U6</b>	<b>U6</b>	<b>U6</b>	<b>U7</b>	<b>U7</b>
Sound power level [Lw] (1)	dB(A)	83,3	83,3	83,8	83,8	92,3	92,3
Sound pressure level at 1m [Lp] (2)	dB(A)	66,3	66,3	66,4	66,4	74,2	74,2
Sound pressure level at 5m [Lp] (3)	dB(A)	56,9	56,9	57,2	57,2	65,5	65,5
Sound pressure level at 10m [Lp] (3)	dB(A)	51,7	51,7	52,1	52,1	60,4	60,4

MODEL		T 120 P2 S	T 120 P2 D	T 150 P2 S	T 150 P2 D	T 170 P4 D	T 175 P3 S
<b>SIZE</b>		<b>U7</b>	<b>U7</b>	<b>U8L</b>	<b>U8L</b>	<b>U8L</b>	<b>U8L</b>
Sound power level [Lw] (1)	dB(A)	92,5	92,5	95,4	95,4	95,4	94,9
Sound pressure level at 1m [Lp] (2)	dB(A)	74,4	74,4	76,0	76,0	76,0	75,5
Sound pressure level at 5m [Lp] (3)	dB(A)	65,6	65,6	68,0	68,0	68,0	67,5
Sound pressure level at 10m [Lp] (3)	dB(A)	60,6	60,6	63,2	63,2	63,2	62,7

MODEL		T 190 P4 D	T 200 P2 S	T 200 P2 D	T 220 P3 S	T 290 P3 S	T 240 P4 D
<b>SIZE</b>		<b>U8L</b>	<b>U8L</b>	<b>U8L</b>	<b>U8L</b>	<b>U9L</b>	<b>Y2</b>
Sound power level [Lw] (1)	dB(A)	94,8	94,8	94,8	94,7	96,4	100,0
Sound pressure level at 1m [Lp] (2)	dB(A)	75,4	75,4	75,4	75,3	76,5	80,2
Sound pressure level at 5m [Lp] (3)	dB(A)	67,5	67,5	67,5	67,4	68,9	72,5
Sound pressure level at 10m [Lp] (3)	dB(A)	62,6	62,6	62,6	62,6	64,1	67,7

MODEL		T 300 P4 D	T 340 P4 D	T 380 P4 D	T 460 P6 D	T 570 P6 D
<b>SIZE</b>		<b>Y2</b>	<b>Y2</b>	<b>Y3</b>	<b>Y3</b>	<b>Y4</b>
Sound power level [Lw] (1)	dB(A)	100,0	100,6	100,7	101,8	103,1
Sound pressure level at 1m [Lp] (2)	dB(A)	80,2	80,8	80,4	81,5	82,3
Sound pressure level at 5m [Lp] (3)	dB(A)	72,5	73,1	73,0	74,1	75,2
Sound pressure level at 10m [Lp] (3)	dB(A)	67,7	68,4	68,3	69,4	70,6

1. Sound power level [Lw] according to ISO EN 9614 - 2.
2. Sound pressure level [Lp] according to ISO EN 3744
3. Sound pressure level [Lp] in free field condition

### IMPORTANT

For further information about units acoustic data, please refer to “The Noise” bulletin of RC GROUP technical literature.

## ELECTRIC DATA

### MAXIMUM ELECTRIC ABSORPTION CALCULATION

This chapter is showing the maximum electrical absorption calculation of machine, corresponding to extreme working conditions.

The involved components are the following:

- Compressors electric motor
- Condensers fans electric motors
- Water pump electric motor (if present)

The electrical data of the various components are indicated in the relative technical data sheets.

EXAMPLE:

Calculation for EAGLE T 90 P2 U7 S:

#### MAXIMUM ELECTRIC ABSORPTION

• Compressors	A	80,0	+
• Condenser fans	A	7,8	=
<b>Maximum electric absorption</b>	<b>A</b>	<b>87,8</b>	

EXAMPLE:

Calculation for EAGLE T 90 P2 U7 S with hydronic group HYG360/1 :

#### MAXIMUM ELECTRIC ABSORPTION

• Compressors	A	80,0	+
• Condenser fans	A	7,8	=
• Water pump	A	3,8	=
<b>Maximum electric absorption</b>	<b>A</b>	<b>91,6</b>	

### IMPORTANT

For water pumps and condenser fans, the current nominal values have been considered equal to the plate value. Therefore the nominal current and the plate current are the same.

In fact, the real absorbed current is normally lower than the plate value.

These values depend on the unit working conditions and on the control type of the plant.

## MP.COM: MICROPROCESSOR CONTROL SYSTEM

The MP.COM microprocessor control system is equipped with 8 keys terminal and back lighted graphic display on which all information in different languages or easily identifiable symbols are displayed.

The system disposes of a “flash” memory that preserves the information even in absence of power supply.

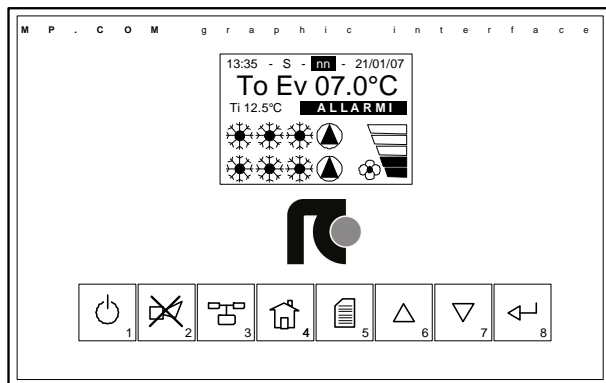

### KEYBOARD FUNCTIONS

- KEY 1** Switches on/off the unit.
- KEY 2** Stops the alarm acoustical signal and displays the intervened alarm.
- KEY 3** Accedes to the parameters of possible units connected in LAN network. LAN connection with 3 wires without additional accessories. It is possible to connect in network different capacity units and with different number of compressors.
- KEY 4** Home key – displays the main screen.
- KEY 5** Accedes to control and visualization menus as:
- Unit working status
  - Set-points
  - Alarms reset (protected by password)
  - Service parameters setting (protected by password)
  - Intervened alarms history
  - Setting for main components manual operation (protected by password)
  - Date and time setting
  - Setting of communication system for SMS messages dispatch
- KEY 6** Scroll the pages inside each menu and decreases the displayed value
- KEY 7** Scroll the pages inside each menu and increases the displayed value
- KEY 8** Shift the cursor inside each menu and confirm a parameter insertion

### REMOTE CONTROLS/ALARMS

#### INLETS

- 1 External enabling •
- 2 Cooling xK1 and Cooling xK2 set-point changeover •

#### OUTLETS

- 1 General alarm 1 ••

- remote controls/alarms
- voltage free controls/alarms

## OPTIONAL ACCESSORIES - “HYG” HYDRONIC GROUP FOR MACHINES SIZE “U5 / U6 / U7”

Factory assembled pumping group with insulated water tank.

The system don't modify the machine dimensions.

In the chillers technical data tables are showed the pumping group type for each machine.

The system includes:

### SINGLE PUMP VERSION – “HYG.../1”

Pumping group with one centrifugal pump:

- Control and working electric equipment built in the water chiller electric board and directly managed by the microprocessor control.
- Pump with 2 poles electric motor.
- Pump housed in soundproofing box for machine with ELN kit.
- Painted and insulated tank.
- Insulated piping.
- Expansion tank.
- Pressure gauge.
- Safety valve.
- Valves on pump suction line.
- Non return valve on pump discharge.
- Safety flow switch.
- Air vent valve.
- Valve for water filling/discharge.
- Water flow regulating valve.
- Non return valve to avoid working conditions with negative pressure.

### TWO PUMPS VERSION - “HYG.../2”

Pumping group with two centrifugal pumps:

- Control and working electric equipment built in the water chiller electric board and directly managed by the microprocessor control.
- Pump with 2 poles electric motor.
- Pump housed in soundproofing box for machine with ELN kit.
- Painted and insulated tank.
- Insulated piping.
- Expansion tank.
- Pressure gauge.
- Safety valve.
- Valves on pump suction line.
- Non return valve on pump discharge.
- Safety flow switch.
- Air vent valve.
- Valve for water filling/discharge.
- Water flow regulating valve.
- Non return valve to avoid working conditions with negative pressure.
- One pump is working and the other is in stand-by. Automatic changeover in case of failure.

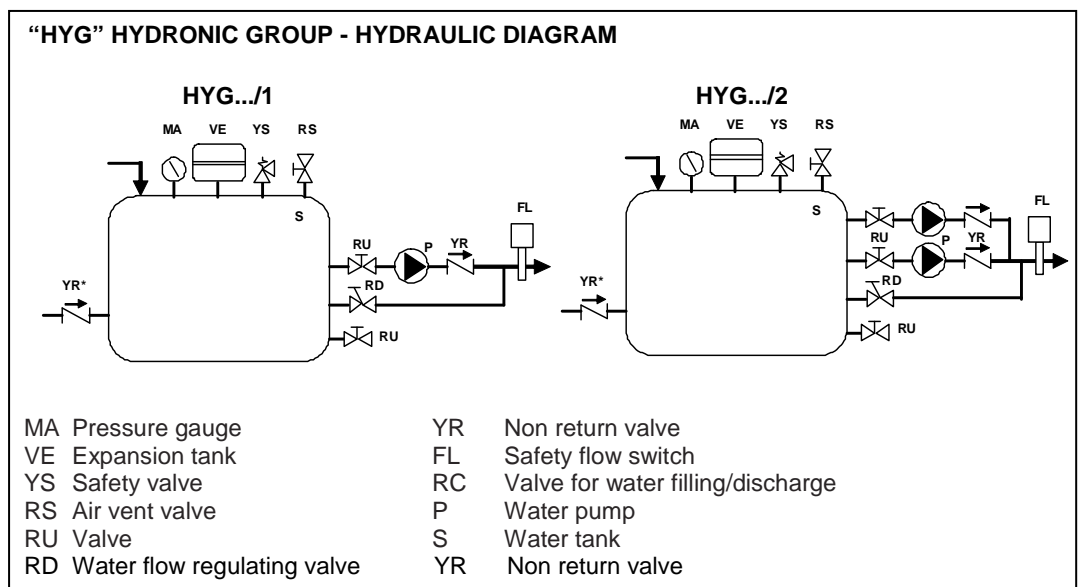

**OPTIONAL ACCESSORIES - "HYG" HYDRONIC GROUP  
FOR MACHINES SIZE "U5 / U6 / U7"**

**TECHNICAL DATA – Pump with 2 poles electric motor**

MODEL WITH 1 PUMP		HYG150/1	HYG240/1	HYG360/1
MODEL WITH 2 PUMPS		HYG150/2	HYG240/2	HYG360/2
<b>WATER FLOW RATE</b>				
Minimum water flow rate	m <sup>3</sup> /h	5	6	5
Maximum water flow rate	m <sup>3</sup> /h	12	20	25
<b>DISCHARGE HEAD</b>				
At minimum water flow rate	kPa	175	210	210
At maximum water flow rate	kPa	138	170	136
<b>WATER PUMPS (1)</b>				
Plate power input	kW	0,75	1,5	1,5
Plate current [FLA]	A	2,1	3,8	3,8
<b>WEIGHT</b>				
VERSION WITH 1 PUMP				
Empty weight (2)	kg	87	102	115
VERSION WITH 2 PUMPS				
Empty weight (2)	kg	106	124	137
<b>WATER TANK</b>				
Water volume	l	150	240	360
Water inlet – ISO228/1-G M	Ø	2"	2"	2 1/2"
Water filling/discharge (3)	Ø	1/2"	1/2"	1/2"
<b>POWER SUPPLY</b>	V/Ph/Hz	400/3/50	400/3/50	400/3/50

- 1 The given values is referred to the working pump only.
- 2 Add this value to the chiller weight.
- 3 Connection for rubber pipe

**WARNING:**

**The noise generated by the pumps does not increase the chiller overall noise pressure level.**

## OPTIONAL ACCESSORIES - “HAL” HYDRONIC GROUP FOR MACHINES SIZE “U8L / U9L / Y2 / Y3 / Y4”

Factory assembled pumping group with special insulated water tank containing the evaporator.

The system don't modify the water chiller dimensions.

In the chillers technical data tables are showed the pumping group type for each unit.

The system includes:

### SINGLE PUMP VERSION - HAL01... / HAL01...LN

Pumping group with one centrifugal pump:

- Control and working electric equipment built in the water chiller electric board and directly managed by the microprocessor control.
- Pump with 2 poles electric motor (HAL01)
- Pump with 4 poles electric motor (HAL01...LN)
- Painted and insulated tank.
- Insulated piping.
- Pressure gauge.
- Safety valve.
- Valves on pump suction line.
- Non return valve on pump discharge.
- Safety flow switch.
- Air vent valve.
- Valve for water filling/discharge.
- Expansion tank, only for U8L, U9L sizes.
- Water flow regulating valve.
- Non return valve to avoid working conditions with negative pressure.

### TWO PUMPS VERSION - HAL02... / HAL02...LN

Pumping group with two centrifugal pumps:

- Control and working electric equipment built in the water chiller electric board and directly managed by the microprocessor control.
- Pump with 2 poles electric motor (HAL02)
- Pump with 4 poles electric motor (HAL02...LN)
- Painted and insulated tank.
- Insulated piping.
- Pressure gauge.
- Safety valve.
- Valves on pump suction line.
- Non return valve on pump discharge.
- Safety flow switch.
- Air vent valve.
- Valve for water filling/discharge.
- Expansion tank, only for U8L, U9L sizes.
- Water flow regulating valve.
- Non return valve to avoid working conditions with negative pressure.
- One pump is working and the other is in stand-by. Automatic changeover in case of failure.

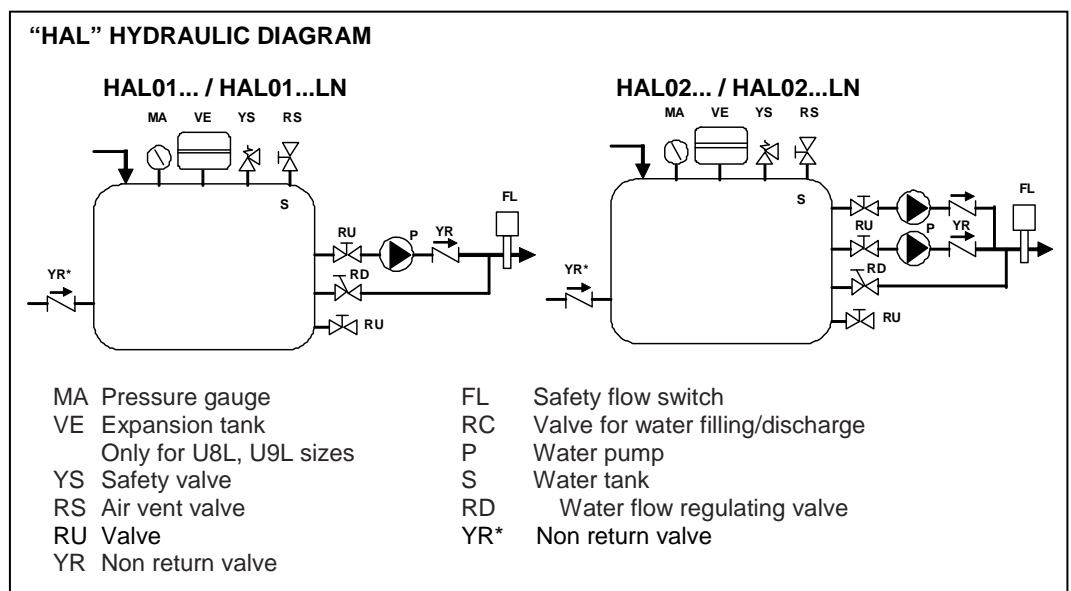

**OPTIONAL ACCESSORIES - “HAL” HYDRONIC GROUP  
FOR MACHINE SIZE “U8L / U9L / Y2 / Y3 / Y4”**

**TECHNICAL DATA – Pumps with 2 poles electric motor “HAL”**

<b>MODEL WITH 1 PUMP</b>		<b>HAL01U8A</b>	<b>HAL01U8B</b>	<b>HAL01U9A</b>	<b>HAL01Y2A</b>	<b>HAL01Y2B</b>	<b>HAL01Y2C</b>	<b>HAL01Y3A</b>	<b>HAL01Y4A</b>
<b>MODEL WITH 2 PUMPS</b>		<b>HAL02U8A</b>	<b>HAL02U8B</b>	<b>HAL02U9A</b>	<b>HAL02Y2A</b>	<b>HAL02Y2B</b>	<b>HAL02Y2C</b>	<b>HAL02Y3A</b>	<b>HAL02Y4A</b>
<b>WATER FLOW RATE</b>									
Minimum water flow rate	m <sup>3</sup> /h	10	10	10	20	40	40	40	40
Maximum water flow rate	m <sup>3</sup> /h	40	45	70	50	75	90	90	100
<b>DISCHARGE HEAD</b>									
At minimum water flow rate	kPa	180	224	170	165	150	180	180	200
At maximum water flow rate	kPa	60	80	65	100	100	100	100	148
<b>WATER PUMPS (1)</b>									
Plate power input	kW	1,5	2,2	2,2	3,0	4,0	4,0	4,0	5,0
Plate current [FLA]	A	3,4	5,0	5,0	6,1	8,8	8,8	8,8	10,3
<b>WEIGHT</b>									
VERSION WITH 1 PUMP									
Empty weight (2)	kg	125	125	185	270	270	270	300	310
VERSION WITH 2 PUMPS									
Empty weight (2)	kg	145	145	230	390	400	410	440	460
<b>WATER TANK</b>									
Water volume	l	500	500	700	500	500	500	800	800
Water inlet – Victaulic	DN	80	80	80	100	100	100	100	100
Water filling/discharge (3)	∅	1/2”	1/2”	1/2”	1/2”	1/2”	1/2”	1/2”	1/2”
<b>POWER SUPPLY</b>	V/Ph/Hz	400/3/50	400/3/50	400/3/50	400/3/50	400/3/50	400/3/50	400/3/50	400/3/50

**TECHNICAL DATA – Pumps with 4 poles electric motor “HAL\_LN”**

<b>MODEL WITH 1 PUMP</b>		<b>HAL01Y2A_LN</b>		<b>HAL01Y2B_LN</b>		<b>HAL01Y3A_LN</b>		<b>HAL01Y4A_LN</b>	
<b>MODEL WITH 2 PUMPS</b>		<b>HAL02Y2A_LN</b>		<b>HAL02Y2B_LN</b>		<b>HAL02Y3A_LN</b>		<b>HAL02Y4A_LN</b>	
<b>WATER FLOW RATE</b>									
Minimum water flow rate	m <sup>3</sup> /h	20		40		40		40	
Maximum water flow rate	m <sup>3</sup> /h	60		120		120		110	
<b>DISCHARGE HEAD</b>									
At minimum water flow rate	kPa	150		148		148		190	
At maximum water flow rate	kPa	125		110		110		128	
<b>WATER PUMPS (1)</b>									
Plate power input	kW	3,0		5,5		5,5		7,5	
Plate current [FLA]	A	7,1		12,5		12,5		15,6	
<b>WEIGHT</b>									
VERSION WITH 1 PUMP									
Empty weight (2)	kg	280		310		340		370	
VERSION WITH 2 PUMPS									
Empty weight (2)	kg	380		440		470		520	
<b>WATER TANK</b>									
Water volume	l	500		500		800		800	
Water inlet – Victaulic	DN	100		100		100		100	
Water filling/discharge (3)	∅	1/2”		1/2”		1/2”		1/2”	
<b>POWER SUPPLY</b>	V/Ph/Hz	400/3/50		400/3/50		400/3/50		400/3/50	

1. The given values is referred to the working pump only
2. Add this value to the chiller weight

**WARNING:**

The noise generated by the pumps does not increase the chiller overall noise pressure level.

## OPTIONAL ACCESSORIES - WATER PUMPS PERFORMANCES

### HOW TO READ THE DIAGRAM

Example for unit EAGLE T 40 P2 U5 S

To obtain the available pressure to the plant proceed as indicated:

- On TECHNICAL DATA Chapter read the nominal water flow rate and pressure drop of the evaporator.
  - Water flow rate = 7,2 m<sup>3</sup>/h
  - Pressure drop = 41 kPa
- Calculate the difference between the maximum available pressure at nominal water flow rate and the evaporator pressure drop.  
170 - 41 = 129 kPa of available pressure.

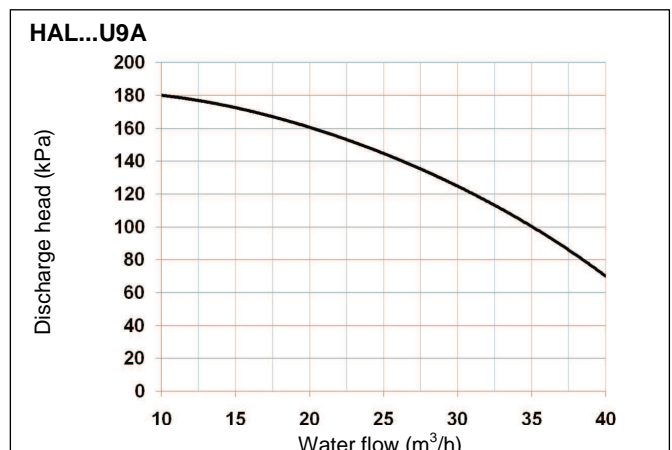
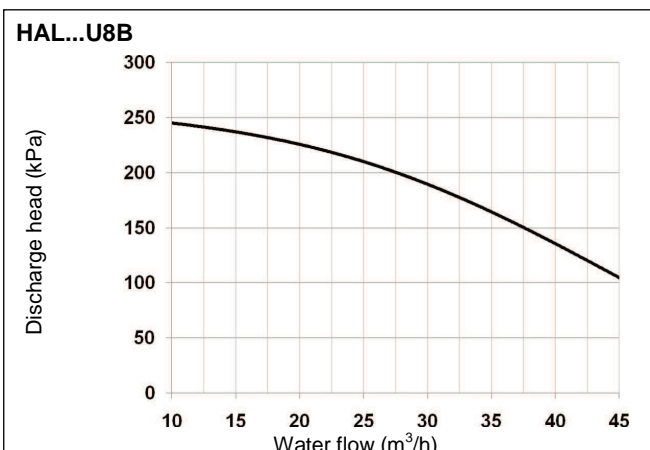
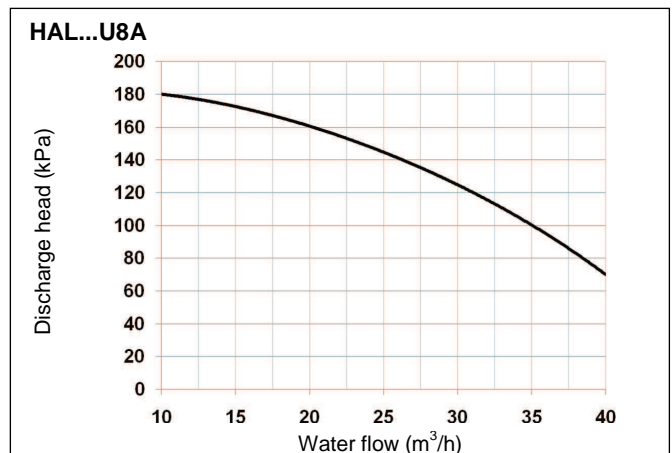
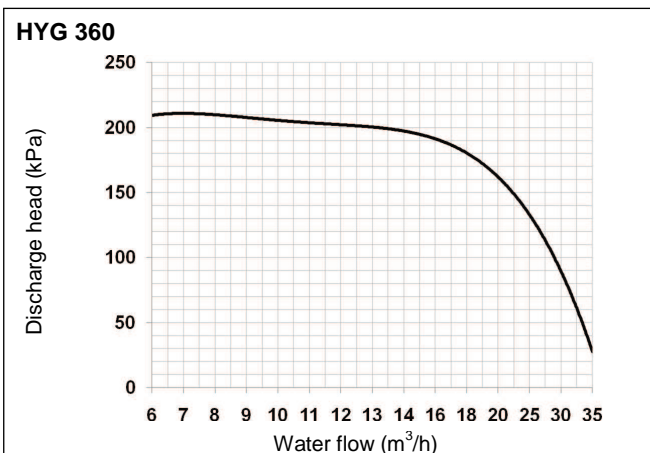
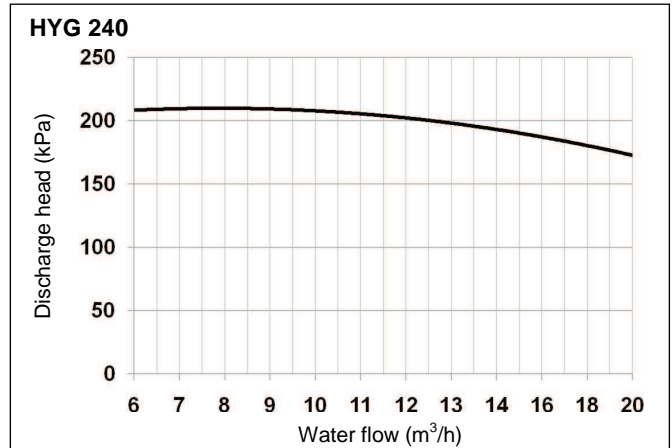
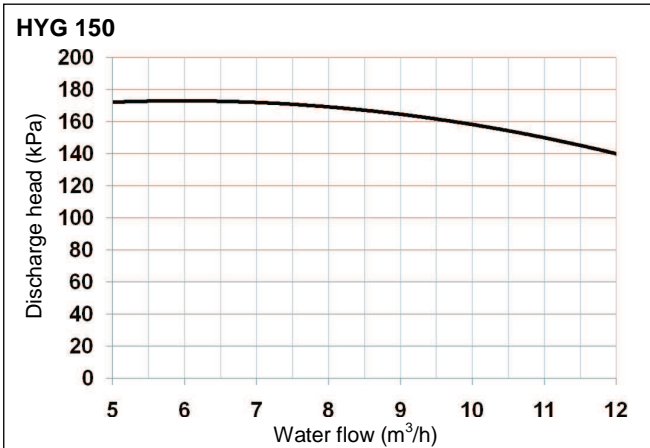
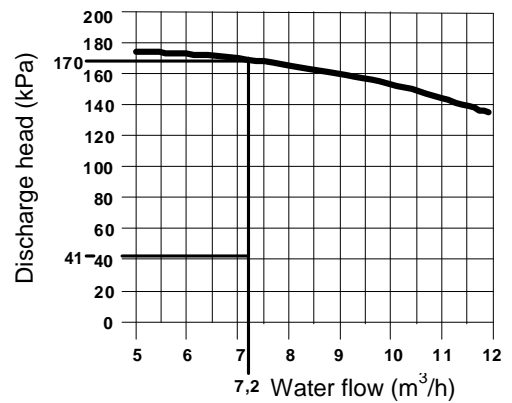

**OPTIONAL ACCESSORIES – WATER PUMPS PERFORMANCES**

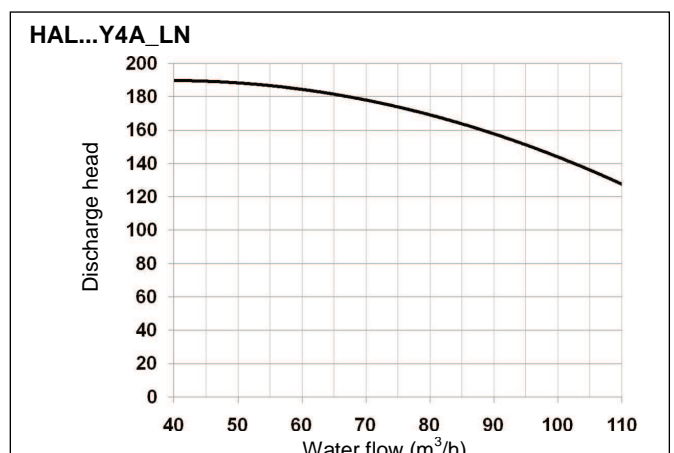
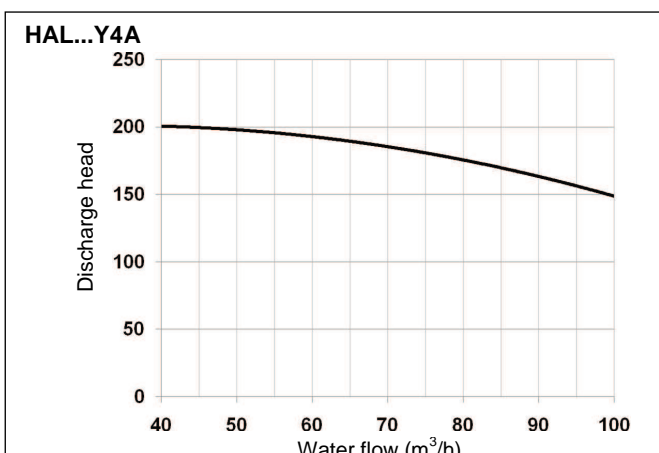
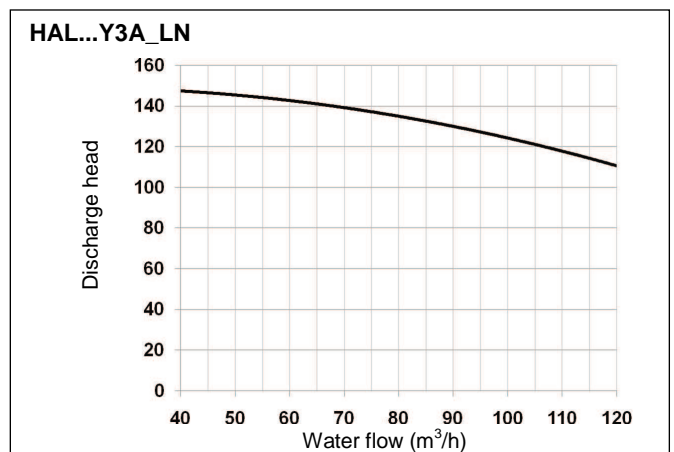
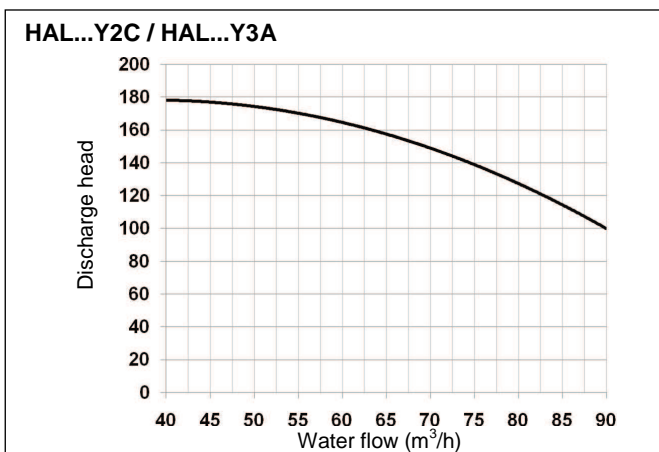
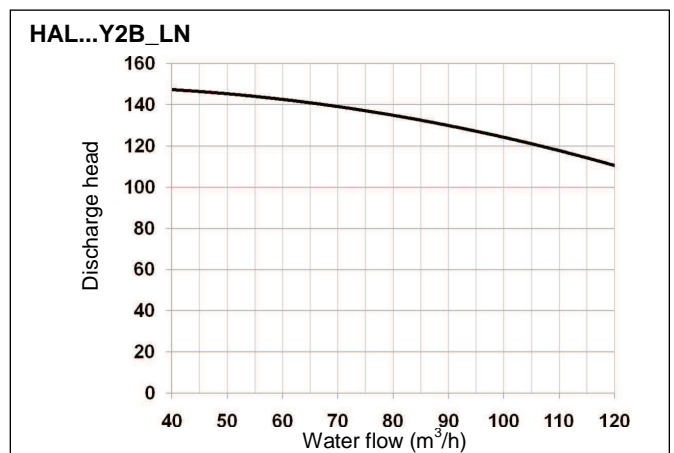
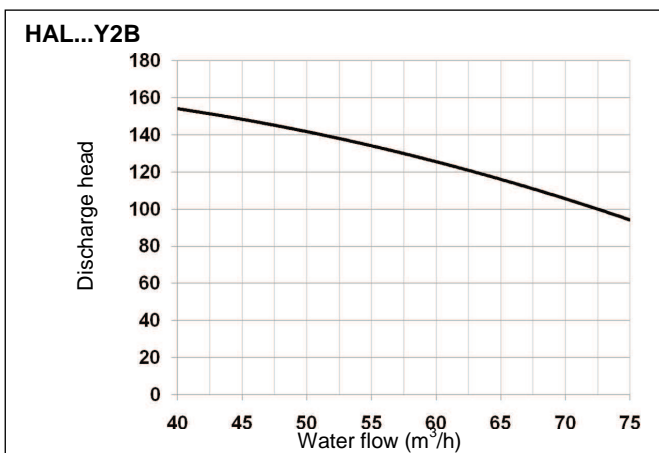
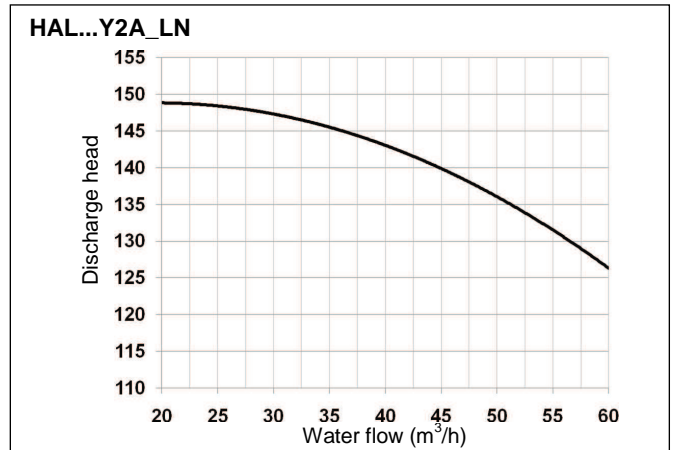
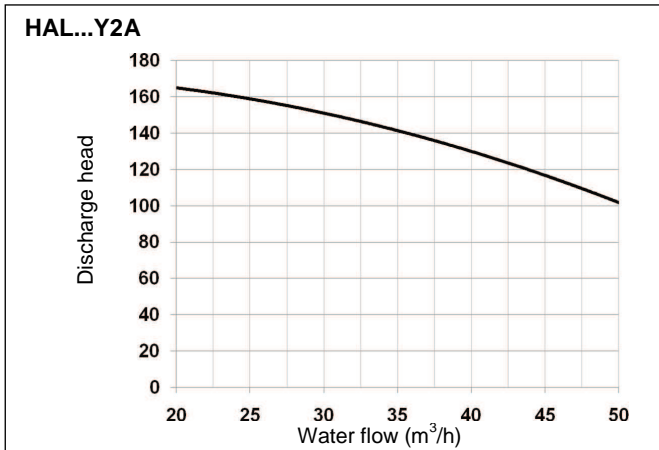

## OPTIONAL ACCESSORIES - LNO KIT

This optional is available as accessory to obtain a machine noise reduction.  
The versions equipped with LNO KIT having the following characteristics:

- Set of the working parameters.
- Machine size “U”:
  - Cap with sound-absorbing material on each compressor
- Machine size “Y”:
  - Compressors box insulated with sound-absorbing material.

The LNO KIT allow 3 different type of set:

### LNO KIT 100%

No air flow reduction.

Noise reduction is obtained through a different working set of the microprocessor control and an acoustic insulation of the noise source.

### LNO KIT 85%

Noise reduction is obtained through a different working set of the microprocessor control, an acoustic insulation of the noise source and a reduction of the condenser coil air flow at 85% of the nominal value.

### LNO KIT 70%

Noise reduction is obtained through a different working set of the microprocessor control, an acoustic insulation of the noise source and a reduction of the condenser coil air flow at 70% of the nominal value.

**Consider that a condenser coil air flow reduction induce a minor cooling capacity of the machine and a major energy consumption of the compressor.**

### WARNING

**To obtain the effective working conditions of cooling capacity and noise reduction for unit equipped with LNO KIT, please refer to the electronic selection catalogue RC WORLD.**

## OPTIONAL ACCESSORIES – LNO KIT FOR MACHINES WITH STANDARD FANS

### VERSION WITH LNO KIT 100% - Air flow at 100%

MODEL		T 40 P2 S	T 40 P2 D	T 48 P2 S	T 48 P2 D	T 54 P2 S	T 54 P2 D
SIZE		U5	U5	U5	U5	U5	U5
Total air flow	m <sup>3</sup> /h	21600	21600	20400	20400	19200	19200
Fans power input	kW	0,56	0,56	1,08	1,08	1,08	1,08
Sound power level [Lw] (1)	dB(A)	81,9	81,9	81,9	81,9	82,0	82,0
Sound pressure level at 1m [Lp] (2)	dB(A)	64,9	64,9	64,9	64,9	64,9	64,9
Sound pressure level at 5m [Lp] (3)	dB(A)	55,5	55,5	55,5	55,5	55,5	55,5
Sound pressure level at 10m [Lp] (3)	dB(A)	50,2	50,2	50,2	50,2	50,3	50,3

MODEL		T 60 P2 S	T 60 P2 D	T 70 P2 S	T 70 P2 D	T 90 P2 S	T 90 P2 D
SIZE		U6	U6	U6	U6	U7	U7
Total air flow	m <sup>3</sup> /h	32400	32400	30600	30600	46400	46400
Fans power input	kW	0,84	0,84	1,62	1,62	3,88	3,88
Sound power level [Lw] (1)	dB(A)	83,2	83,2	83,7	83,7	92,2	92,2
Sound pressure level at 1m [Lp] (2)	dB(A)	66,2	66,2	66,2	66,2	74,1	74,1
Sound pressure level at 5m [Lp] (3)	dB(A)	56,8	56,8	57,1	57,1	65,4	65,4
Sound pressure level at 10m [Lp] (3)	dB(A)	51,5	51,5	51,9	51,9	60,3	60,3

MODEL		T 120 P2 S	T 120 P2 D	T 150 P2 S	T 150 P2 D	T 170 P4 D	T 175 P3 S
SIZE		U7	U7	U8L	U8L	U8L	U8L
Total air flow	m <sup>3</sup> /h	46400	46400	69600	69600	69600	88000
Fans power input	kW	3,88	3,88	5,82	5,82	5,82	7,76
Sound power level [Lw] (1)	dB(A)	92,3	92,3	95,2	95,2	95,2	94,7
Sound pressure level at 1m [Lp] (2)	dB(A)	74,2	74,2	75,8	75,8	75,8	75,3
Sound pressure level at 5m [Lp] (3)	dB(A)	65,5	65,5	67,9	67,9	67,9	67,4
Sound pressure level at 10m [Lp] (3)	dB(A)	60,4	60,4	63,1	63,1	63,1	62,5

MODEL		T 190 P4 D	T 200 P2 S	T 200 P2 D	T 220 P3 S	T 290 P3 S	T 240 P4 D
SIZE		U8L	U8L	U8L	U8L	U9L	Y2
Total air flow	m <sup>3</sup> /h	86000	86000	86000	86000	126000	132000
Fans power input	kW	7,76	7,76	7,76	7,76	11,64	11,64
Sound power level [Lw] (1)	dB(A)	94,6	94,6	94,6	94,6	96,2	96,3
Sound pressure level at 1m [Lp] (2)	dB(A)	75,3	75,3	75,3	75,2	76,3	76,5
Sound pressure level at 5m [Lp] (3)	dB(A)	67,3	67,3	67,3	67,3	68,7	68,8
Sound pressure level at 10m [Lp] (3)	dB(A)	62,5	62,5	62,5	62,5	64,0	64,1

MODEL		T 300 P4 D	T 340 P4 D	T 380 P4 D	T 460 P6 D	T 570 P6 D
SIZE		Y2	Y2	Y3	Y3	Y4
Total air flow	m <sup>3</sup> /h	126000	126000	176000	171600	214500
Fans power input	kW	11,64	11,64	15,52	15,52	19,40
Sound power level [Lw] (1)	dB(A)	96,3	96,4	97,3	97,5	98,5
Sound pressure level at 1m [Lp] (2)	dB(A)	76,5	76,6	77,0	77,2	77,7
Sound pressure level at 5m [Lp] (3)	dB(A)	68,8	68,9	69,6	69,8	70,5
Sound pressure level at 10m [Lp] (3)	dB(A)	64,1	64,2	65,0	65,1	66,0

1. Sound power level [Lw] according to ISO EN 9614 - 2.
2. Sound pressure level [Lp] according to ISO EN 3744
3. Sound pressure level [Lp] in free field condition

## OPTIONAL ACCESSORIES – LNO KIT FOR MACHINES WITH STANDARD FANS

### VERSION WITH LNO KIT 85% - Air flow at 85%

MODEL		T 40 P2 S	T 40 P2 D	T 48 P2 S	T 48 P2 D	T 54 P2 S	T 54 P2 D
SIZE		U5	U5	U5	U5	U5	U5
Total air flow	m <sup>3</sup> /h	18360	18360	17340	17340	16320	16320
Fans power input	kW	0,48	0,48	0,92	0,92	0,92	0,92
Sound power level [Lw] (1)	dB(A)	78,5	78,5	78,5	78,5	78,6	78,6
Sound pressure level at 1m [Lp] (2)	dB(A)	61,5	61,5	61,5	61,5	61,5	61,5
Sound pressure level at 5m [Lp] (3)	dB(A)	52,1	52,1	52,1	52,1	52,1	52,1
Sound pressure level at 10m [Lp] (3)	dB(A)	46,9	46,9	46,9	46,9	46,9	46,9

MODEL		T 60 P2 S	T 60 P2 D	T 70 P2 S	T 70 P2 D	T 90 P2 S	T 90 P2 D
SIZE		U6	U6	U6	U6	U7	U7
Total air flow	m <sup>3</sup> /h	27540	27540	26010	26010	39440	39440
Fans power input	kW	0,71	0,71	1,38	1,38	3,30	3,30
Sound power level [Lw] (1)	dB(A)	79,9	79,9	80,3	80,3	88,8	88,8
Sound pressure level at 1m [Lp] (2)	dB(A)	62,8	62,8	62,9	62,9	70,7	70,7
Sound pressure level at 5m [Lp] (3)	dB(A)	53,4	53,4	53,7	53,7	62,0	62,0
Sound pressure level at 10m [Lp] (3)	dB(A)	48,2	48,2	48,6	48,6	56,9	56,9

MODEL		T 120 P2 S	T 120 P2 D	T 150 P2 S	T 150 P2 D	T 170 P4 D	T 175 P3 S
SIZE		U7	U7	U8L	U8L	U8L	U8L
Total air flow	m <sup>3</sup> /h	39440	39440	59160	59160	59160	74800
Fans power input	kW	3,30	3,30	4,95	4,95	4,95	6,60
Sound power level [Lw] (1)	dB(A)	89,0	89,0	91,9	91,9	91,9	91,4
Sound pressure level at 1m [Lp] (2)	dB(A)	70,9	70,9	72,5	72,5	72,5	72,0
Sound pressure level at 5m [Lp] (3)	dB(A)	62,1	62,1	64,5	64,5	64,5	64,1
Sound pressure level at 10m [Lp] (3)	dB(A)	57,1	57,1	59,7	59,7	59,7	59,2

MODEL		T 190 P4 D	T 200 P2 S	T 200 P2 D	T 220 P3 S	T 290 P3 S	T 240 P4 D
SIZE		U8L	U8L	U8L	U8L	U9L	Y2
Total air flow	m <sup>3</sup> /h	73100	73100	73100	73100	107100	112200
Fans power input	kW	6,60	6,60	6,60	6,60	9,89	9,89
Sound power level [Lw] (1)	dB(A)	91,3	91,3	91,3	91,2	92,9	93,3
Sound pressure level at 1m [Lp] (2)	dB(A)	71,9	71,9	71,9	71,9	73,0	73,5
Sound pressure level at 5m [Lp] (3)	dB(A)	64,0	64,0	64,0	63,9	65,4	65,8
Sound pressure level at 10m [Lp] (3)	dB(A)	59,2	59,2	59,2	59,1	60,7	61,0

MODEL		T 300 P4 D	T 340 P4 D	T 380 P4 D	T 460 P6 D	T 570 P6 D
SIZE		Y2	Y2	Y3	Y3	Y4
Total air flow	m <sup>3</sup> /h	107100	107100	149600	145860	182325
Fans power input	kW	9,89	9,89	13,19	13,19	16,49
Sound power level [Lw] (1)	dB(A)	93,3	93,4	94,2	94,6	95,6
Sound pressure level at 1m [Lp] (2)	dB(A)	73,5	73,7	73,9	74,2	74,8
Sound pressure level at 5m [Lp] (3)	dB(A)	65,8	66,0	66,5	66,9	67,7
Sound pressure level at 10m [Lp] (3)	dB(A)	61,0	61,2	61,8	62,2	63,1

1. Sound power level [Lw] according to ISO EN 9614 - 2.
2. Sound pressure level [Lp] according to ISO EN 3744
3. Sound pressure level [Lp] in free field condition

## OPTIONAL ACCESSORIES – LNO KIT FOR MACHINES WITH STANDARD FANS

### VERSION WITH LNO KIT 70% - Air flow at 70%

MODEL		T 40 P2 S	T 40 P2 D	T 48 P2 S	T 48 P2 D	T 54 P2 S	T 54 P2 D
SIZE		U5	U5	U5	U5	U5	U5
Total air flow	m <sup>3</sup> /h	15120	15120	14280	14280	13440	13440
Fans power input	kW	0,39	0,39	0,76	0,76	0,76	0,76
Sound power level [Lw] (1)	dB(A)	74,7	74,7	74,7	74,7	74,7	74,7
Sound pressure level at 1m [Lp] (2)	dB(A)	57,7	57,7	57,7	57,7	57,7	57,7
Sound pressure level at 5m [Lp] (3)	dB(A)	48,2	48,2	48,2	48,2	48,2	48,2
Sound pressure level at 10m [Lp] (3)	dB(A)	43,0	43,0	43,0	43,0	43,0	43,0

MODEL		T 60 P2 S	T 60 P2 D	T 70 P2 S	T 70 P2 D	T 90 P2 S	T 90 P2 D
SIZE		U6	U6	U6	U6	U7	U7
Total air flow	m <sup>3</sup> /h	22680	22680	21420	21420	32480	32480
Fans power input	kW	0,59	0,59	1,13	1,13	2,72	2,72
Sound power level [Lw] (1)	dB(A)	76,1	76,1	76,7	76,7	84,9	84,9
Sound pressure level at 1m [Lp] (2)	dB(A)	59,0	59,0	59,2	59,2	66,8	66,8
Sound pressure level at 5m [Lp] (3)	dB(A)	49,6	49,6	50,1	50,1	58,0	58,0
Sound pressure level at 10m [Lp] (3)	dB(A)	44,4	44,4	44,9	44,9	53,0	53,0

MODEL		T 120 P2 S	T 120 P2 D	T 150 P2 S	T 150 P2 D	T 170 P4 D	T 175 P3 S
SIZE		U7	U7	U8L	U8L	U8L	U8L
Total air flow	m <sup>3</sup> /h	32480	32480	48720	48720	48720	61600
Fans power input	kW	2,72	2,72	4,07	4,07	4,07	5,43
Sound power level [Lw] (1)	dB(A)	85,3	85,3	88,0	88,0	88,0	87,8
Sound pressure level at 1m [Lp] (2)	dB(A)	67,2	67,2	68,6	68,6	68,6	68,4
Sound pressure level at 5m [Lp] (3)	dB(A)	58,5	58,5	60,7	60,7	60,7	60,5
Sound pressure level at 10m [Lp] (3)	dB(A)	53,4	53,4	55,9	55,9	55,9	55,6

MODEL		T 190 P4 D	T 200 P2 S	T 200 P2 D	T 220 P3 S	T 290 P3 S	T 240 P4 D
SIZE		U8L	U8L	U8L	U8L	U9L	Y2
Total air flow	m <sup>3</sup> /h	60200	60200	60200	60200	88200	92400
Fans power input	kW	5,43	5,43	5,43	5,43	8,15	8,15
Sound power level [Lw] (1)	dB(A)	87,6	87,6	87,6	87,5	89,3	90,2
Sound pressure level at 1m [Lp] (2)	dB(A)	68,3	68,3	68,3	68,1	69,4	70,4
Sound pressure level at 5m [Lp] (3)	dB(A)	60,3	60,3	60,3	60,2	61,8	62,7
Sound pressure level at 10m [Lp] (3)	dB(A)	55,5	55,5	55,5	55,3	57,1	57,9

MODEL		T 300 P4 D	T 340 P4 D	T 380 P4 D	T 460 P6 D	T 570 P6 D
SIZE		Y2	Y2	Y3	Y3	Y4
Total air flow	m <sup>3</sup> /h	88200	88200	123200	120120	150150
Fans power input	kW	8,15	8,15	10,86	10,86	13,58
Sound power level [Lw] (1)	dB(A)	90,2	90,6	91,0	91,7	92,9
Sound pressure level at 1m [Lp] (2)	dB(A)	70,4	70,8	70,7	71,4	72,1
Sound pressure level at 5m [Lp] (3)	dB(A)	62,7	63,1	63,3	64,0	64,9
Sound pressure level at 10m [Lp] (3)	dB(A)	57,9	58,3	58,7	59,3	60,4

1. Sound power level [Lw] according to ISO EN 9614 - 2.
2. Sound pressure level [Lp] according to ISO EN 3744
3. Sound pressure level [Lp] in free field condition

## OPTIONAL ACCESSORIES - ELN KIT

This optional is available as accessory to obtain an extreme machine noise reduction.  
The versions equipped with ELN KIT having the following characteristics:

- Set of the working parameters.
- Axial fans equipped with EC motors.
- Machine size "U":
  - Machine frame and panels insulated with soundproofing material.
  - Soundproof cap on each compressor.
- Machine size "Y":
  - Compressor box insulated with soundproofing material.
  - Machine frame and panels insulated with soundproofing material.
  - Refrigerant discharge and suction pipes insulated with soundproofing material.

**Consider that a condenser coil air flow reduction induce a minor cooling capacity of the machine and a major energy consumption of the compressor.**

### WARNING

**To obtain the effective working conditions of cooling capacity and noise reduction for unit equipped with ELN KIT, please refer to the electronic selection catalogue RC WORLD.**

MODEL		T 40 P2 S	T 40 P2 D	T 48 P2 S	T 48 P2 D	T 54 P2 S	T 54 P2 D
<b>SIZE</b>		<b>U5</b>	<b>U5</b>	<b>U5</b>	<b>U5</b>	<b>U5</b>	<b>U5</b>
Total air flow	m <sup>3</sup> /h	15120	15120	14280	14280	13440	13440
Fans power input	kW	0,41	0,41	0,61	0,61	0,61	0,61
Sound power level [Lw] (1)	dB(A)	72,7	72,7	72,7	72,7	72,7	72,7
Sound pressure level at 1m [Lp] (2)	dB(A)	55,7	55,7	55,7	55,7	55,7	55,7
Sound pressure level at 5m [Lp] (3)	dB(A)	46,2	46,2	46,2	46,2	46,2	46,2
Sound pressure level at 10m [Lp] (3)	dB(A)	41,0	41,0	41,0	41,0	41,0	41,0

MODEL		T 60 P2 S	T 60 P2 D	T 70 P2 S	T 70 P2 D	T 90 P2 S	T 90 P2 D
<b>SIZE</b>		<b>U6</b>	<b>U6</b>	<b>U6</b>	<b>U6</b>	<b>U7</b>	<b>U7</b>
Total air flow	m <sup>3</sup> /h	22680	22680	21420	21420	32480	32480
Fans power input	kW	0,61	0,61	1,17	1,17	1,17	1,17
Sound power level [Lw] (1)	dB(A)	74,1	74,1	74,7	74,7	82,9	82,9
Sound pressure level at 1m [Lp] (2)	dB(A)	57,0	57,0	57,2	57,2	64,8	64,8
Sound pressure level at 5m [Lp] (3)	dB(A)	47,6	47,6	48,1	48,1	56,0	56,0
Sound pressure level at 10m [Lp] (3)	dB(A)	42,4	42,4	42,9	42,9	51,0	51,0

MODEL		T 120 P2 S	T 120 P2 D	T 150 P2 S	T 150 P2 D	T 170 P4 D	T 175 P3 S
<b>SIZE</b>		<b>U7</b>	<b>U7</b>	<b>U8L</b>	<b>U8L</b>	<b>U8L</b>	<b>U8L</b>
Total air flow	m <sup>3</sup> /h	32480	32480	48720	48720	48720	61600
Fans power input	kW	1,75	1,75	2,33	2,33	2,33	2,33
Sound power level [Lw] (1)	dB(A)	83,3	83,3	86,0	86,0	86,0	85,8
Sound pressure level at 1m [Lp] (2)	dB(A)	65,2	65,2	66,6	66,6	66,6	66,4
Sound pressure level at 5m [Lp] (3)	dB(A)	56,5	56,5	58,7	58,7	58,7	58,5
Sound pressure level at 10m [Lp] (3)	dB(A)	51,4	51,4	53,9	53,9	53,9	53,6

MODEL		T 190 P4 D	T 200 P2 S	T 200 P2 D	T 220 P3 S	T 290 P3 S	T 240 P4 D
<b>SIZE</b>		<b>U8L</b>	<b>U8L</b>	<b>U8L</b>	<b>U8L</b>	<b>U9L</b>	<b>Y2</b>
Total air flow	m <sup>3</sup> /h	60200	60200	60200	60200	88200	92400
Fans power input	kW	3,50	3,50	3,50	3,50	3,50	3,50
Sound power level [Lw] (1)	dB(A)	85,6	85,6	85,6	85,5	87,3	88,2
Sound pressure level at 1m [Lp] (2)	dB(A)	66,3	66,3	66,3	66,1	67,4	68,4
Sound pressure level at 5m [Lp] (3)	dB(A)	58,3	58,3	58,3	58,2	59,8	60,7
Sound pressure level at 10m [Lp] (3)	dB(A)	53,5	53,5	53,5	53,3	55,1	55,9

MODEL		T 300 P4 D	T 340 P4 D	T 380 P4 D	T 460 P6 D	T 570 P6 D
<b>SIZE</b>		<b>Y2</b>	<b>Y2</b>	<b>Y3</b>	<b>Y3</b>	<b>Y4</b>
Total air flow	m <sup>3</sup> /h	88200	88200	123200	120120	150150
Fans power input	kW	4,66	4,66	5,83	5,83	5,83
Sound power level [Lw] (1)	dB(A)	88,2	88,6	89,0	89,7	90,9
Sound pressure level at 1m [Lp] (2)	dB(A)	68,4	68,8	68,7	69,4	70,1
Sound pressure level at 5m [Lp] (3)	dB(A)	60,7	61,1	61,3	62,0	62,9
Sound pressure level at 10m [Lp] (3)	dB(A)	55,9	56,3	56,7	57,3	58,4

1. Sound power level [Lw] according to ISO EN 9614 - 2.
2. Sound pressure level [Lp] according to ISO EN 3744
3. Sound pressure level [Lp] in free field condition

### OPTIONAL ACCESSORIES – “EC” AXIAL FANS

The “EC” axial fans are equipped with a brushless type synchronous motor with integrated electronic commutated system.

The motor rotation control is obtained with the EC system (Electronic Commutation) that manage the motor according to the 0÷10V proportional signal coming from the microprocessor control.

Characteristics of “EC” motors:

- no electromagnetic noise
- efficiency 83÷86%
- minimum power input

Characteristics comparison between an “AC” asynchronous electric motor with phase-cut control (voltage controller) and “EC” brushless type synchronous motor.

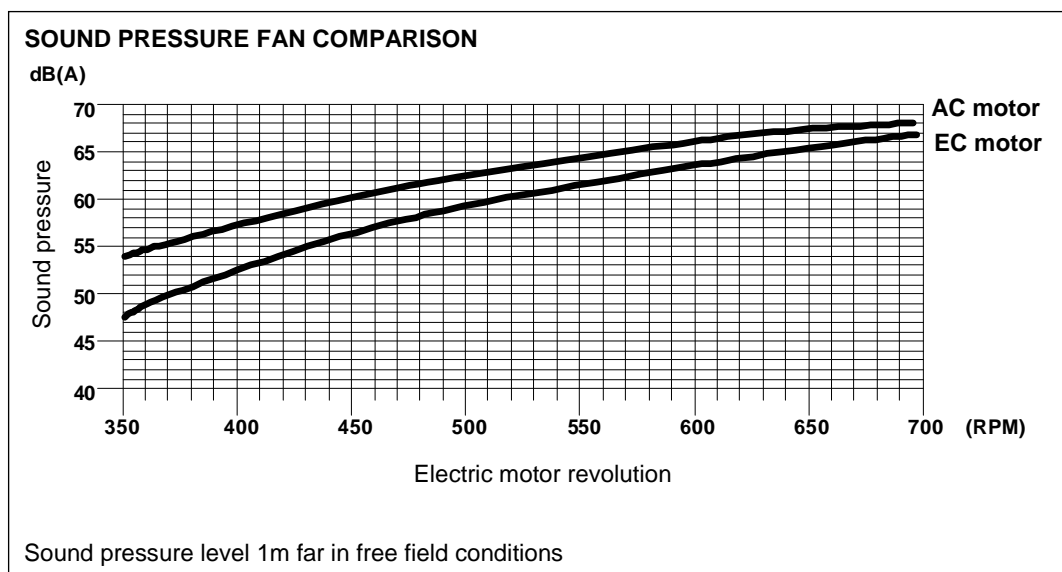
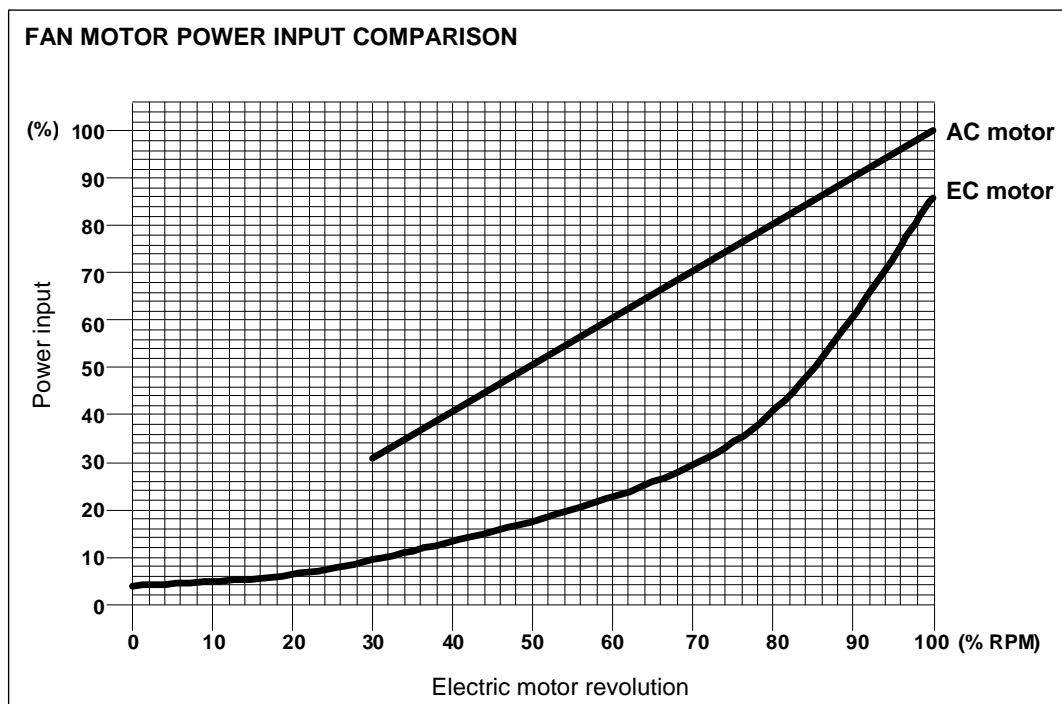

**WARNING**

The graphs are referred to working condition with null available static pressure (0 Pa).

### OPTIONAL ACCESSORIES - PARTIAL HEAT RECOVERY SYSTEM

The partial heat recovery exchangers are installed on every refrigerant circuit of the machine before the main condenser.

The system is not regulated and the control is ON-OFF type. The heat recovery system's operation is subject to the supply demand of cooling capacity.

The system includes:

- Copper brazed plate type heat exchanger with cover plates, plates and connections in AISI 316 stainless steel.
- Antic condensate insulation made of polyurethane.
- Antifreeze heater (only machine size "Y").
- Hydraulic piping. In the machines size "Y", with two refrigerant circuits, the parallel connection of the hydraulic circuit is at Customer care.

The heating capacity which is supplied depends on the kind of refrigerant gas which is used and working temperatures.

The heat exchangers can produce hot water up to the maximum temperature of 70-75°C and according to the working conditions of the unit.

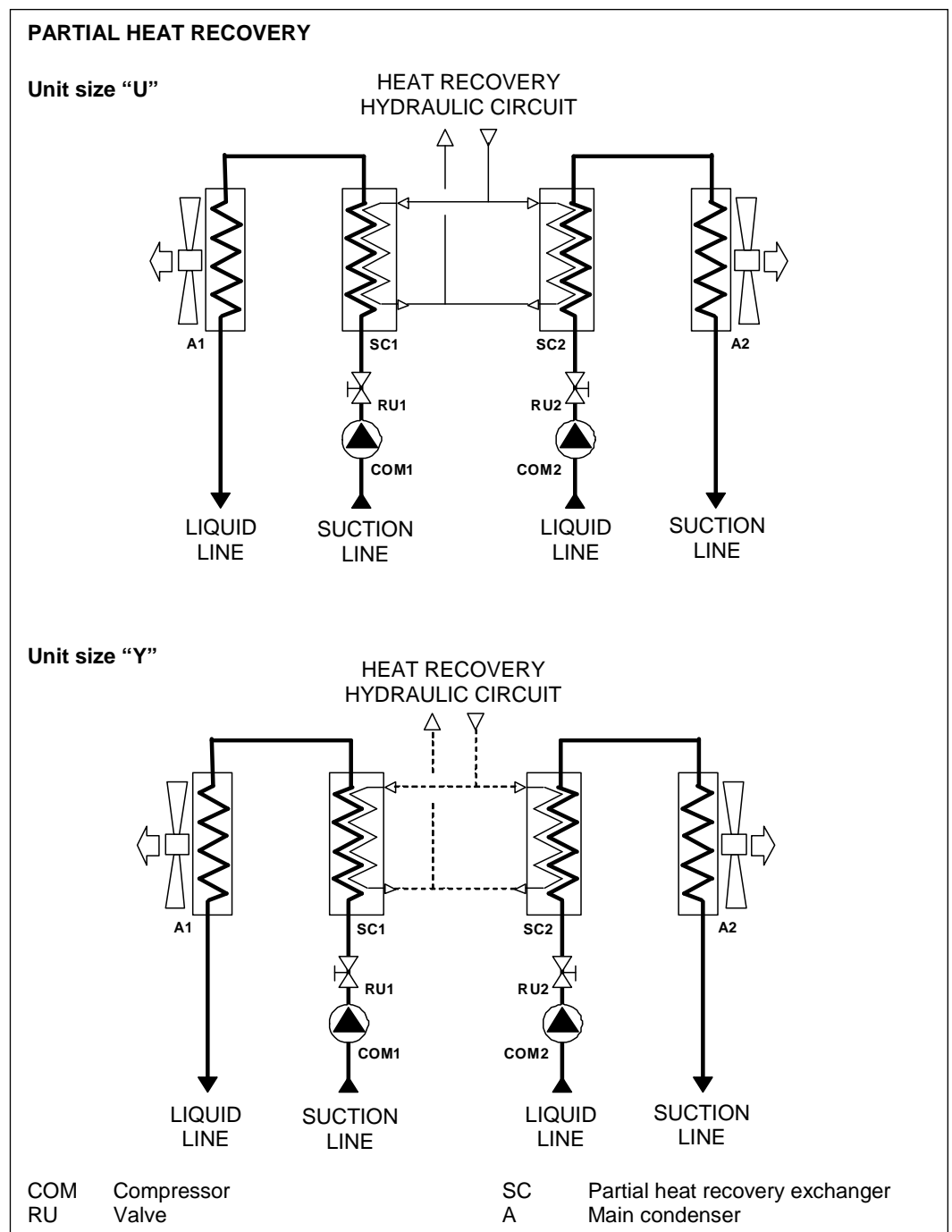

### OPTIONAL ACCESSORIES - TOTAL HEAT RECOVERY SYSTEM

The total heat recovery exchange is installed in parallel to the main condenser. The system is totally controlled by the microprocessor and the control is ON-OFF type. The heat recovery system's operation is subject to the supply demand of cooling capacity. The system includes:

- Copper brazed plate type heat exchanger with cover plates, plates and connections in AISI 316 stainless steel.
- Anticondensate insulation made of polyurethane.
- Antifreeze heater (only machine size "Y").
- Water temperature probe on heat reclaim water inlet.
- Diverter valve.
- Non return valve.
- Liquid receiver
- Safety valve.

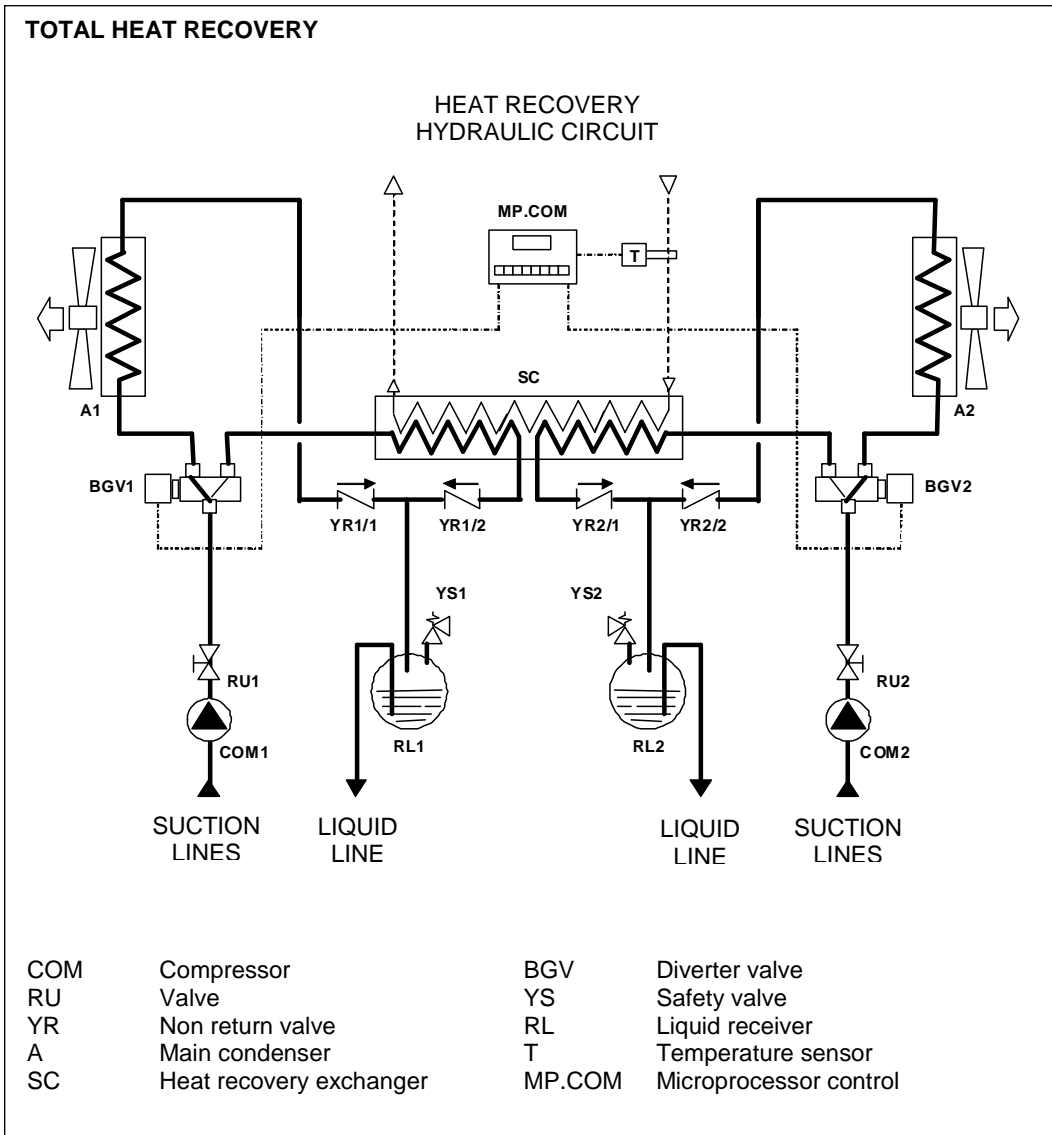

**MACHINE DRAWINGS**

Dimensions in mm

SIZE U5 S

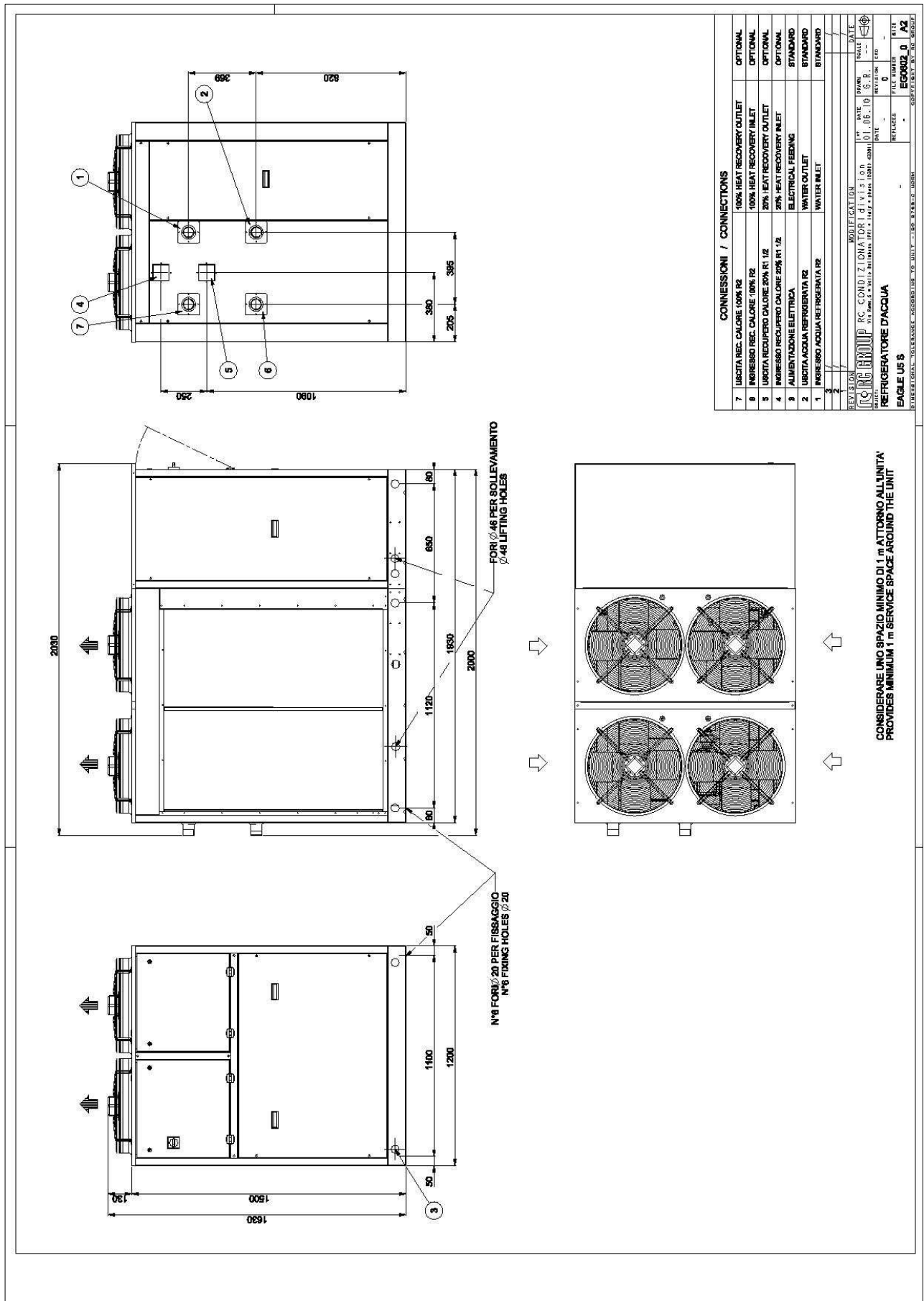

**MACHINE DRAWINGS**  
Dimensions in mm

SIZE U5 D

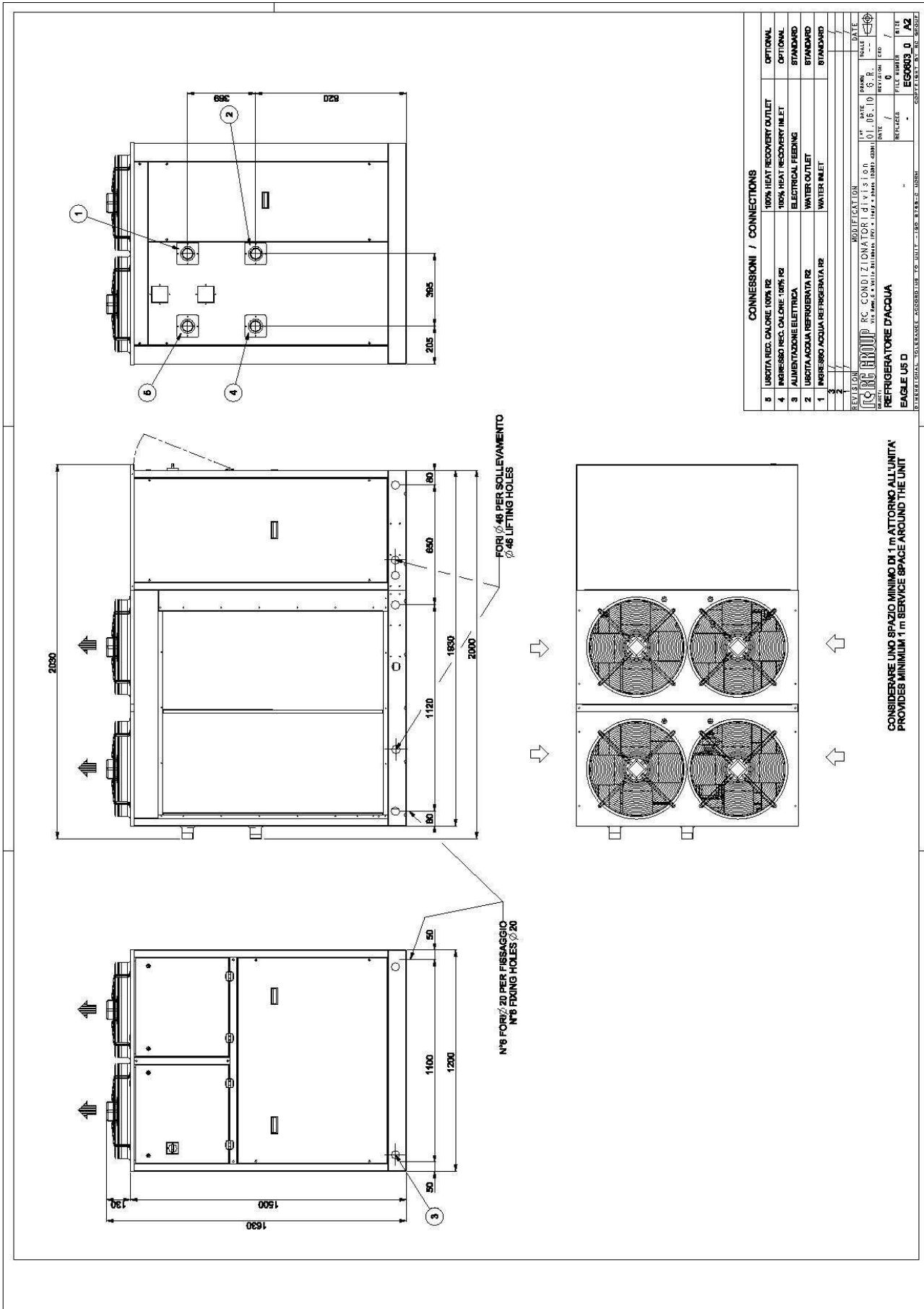

**MACHINE DRAWINGS**  
Dimensions in mm

**SIZE U6 S**

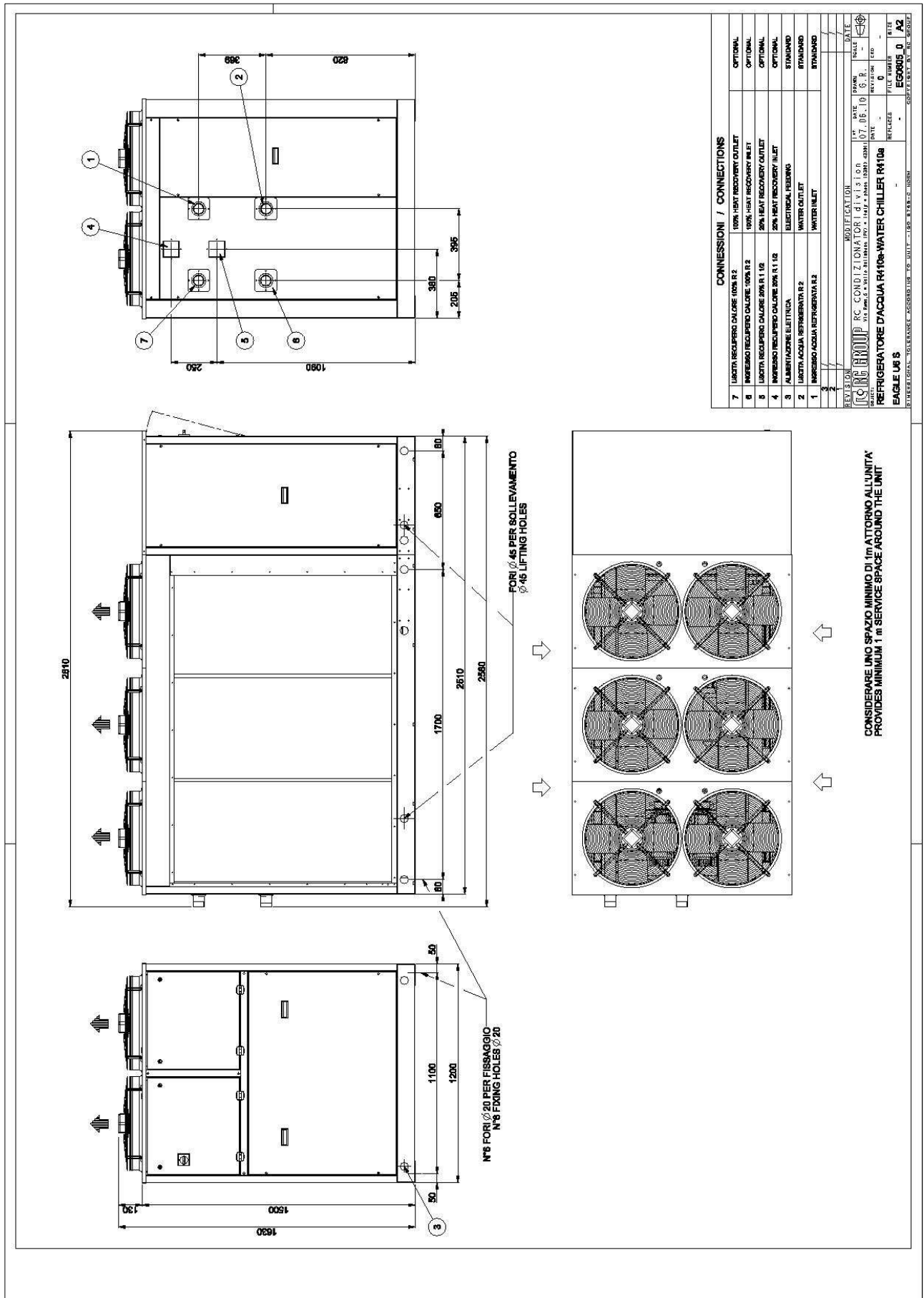

**CONNESSIONI / CONNECTIONS**

7	USCITA RECUPERO CALORE 100% R2	100% HEAT RECOVERY OUTLET	OPTIONAL
6	INGRESSO RECUPERO CALORE 100% R2	100% HEAT RECOVERY INLET	OPTIONAL
5	USCITA RECUPERO CALORE 20% R1 R2	20% HEAT RECOVERY OUTLET	OPTIONAL
4	INGRESSO RECUPERO CALORE 20% R1 R2	20% HEAT RECOVERY INLET	OPTIONAL
3	ALIMENTAZIONE ELETTRICA	ELECTRICAL FEEDING	STANDARD
2	USCITA ACQUA REFRIGERATA R2	WATER OUTLET	STANDARD
1	INGRESSO ACQUA REFRIGERATA R2	WATER INLET	STANDARD

RC GROUP  
 RC CONDIZIONATORI 4101109  
 REFRIGERATORE D'ACQUA R410a-WATER CHILLER R410a  
 EAGLE UR S  
 MODEL: 4101109  
 DATE: 07.06.10  
 DRAWN: G.R.  
 CHECKED: G.R.  
 REVISED: -  
 FILE NUMBER: E50805 0\_A2  
 REFERENCE: -  
 PROJECT: -  
 SCALE: 1:1  
 SHEET: 1/1  
 TOTAL SHEETS: 1

CONSIDERARE UNO SPAZIO MINIMO DI 1m ATTORNO ALL'UNITA'  
PROVIDES MINIMUM 1 m SERVICE SPACE AROUND THE UNIT

N°8 FORI Ø20 PER FISSAGGIO  
N°8 FIXING HOLES Ø20

FORI Ø46 PER SOLLEVAMENTO  
Ø46 LIFTING HOLES

**MACHINE DRAWINGS**  
Dimensions in mm

SIZE U6 D

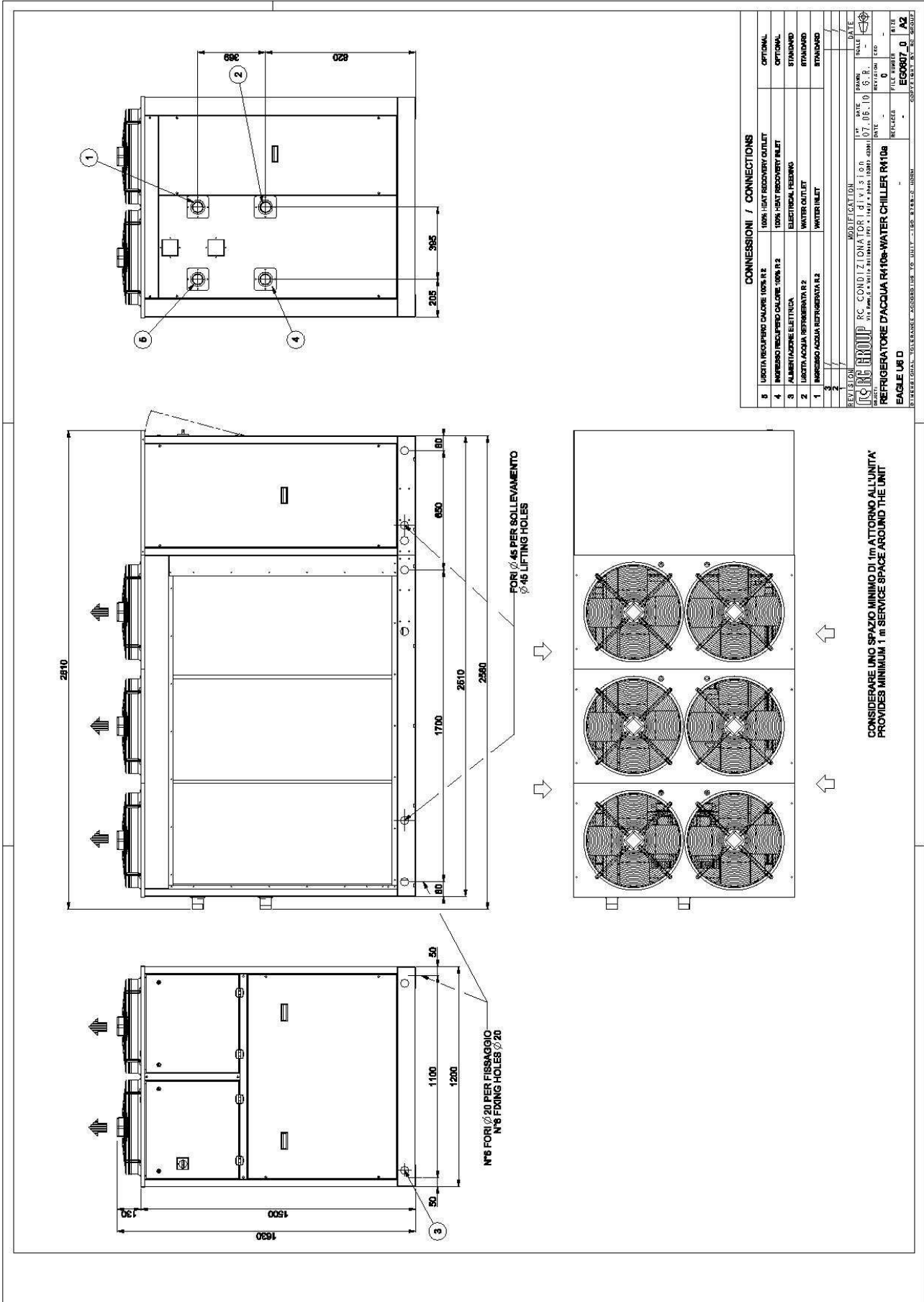

**MACHINE DRAWINGS**  
Dimensions in mm

SIZE U7 S

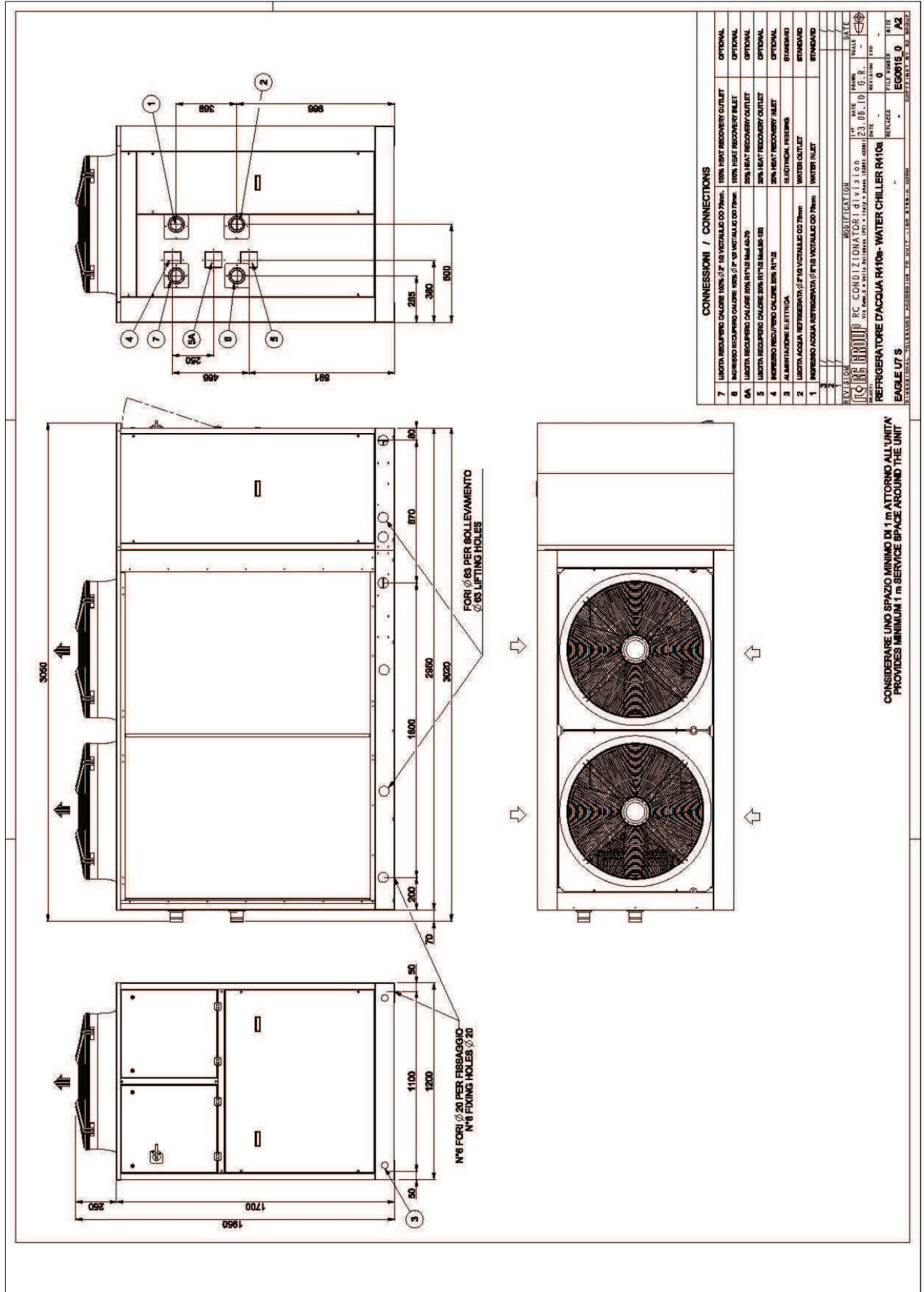

CONNESSIONI / CONNECTIONS	
7	UNITA' RECUPERO CALORE 100% Ø 2" IN VETROLO ØD 75mm. 100% HEAT RECOVERY OUTLET
8	INGRESSO RECUPERO CALORE 100% Ø 2" IN VETROLO ØD 75mm. 100% HEAT RECOVERY INLET
5A	UNITA' RECUPERO CALORE 50% R112 IN ALU ØD 75. 50% HEAT RECOVERY OUTLET
5	UNITA' RECUPERO CALORE 50% R112 IN ALU ØD 75. 50% HEAT RECOVERY INLET
4	INGRESSO RECUPERO CALORE 50% R112. 50% HEAT RECOVERY INLET
3	ALIMENTAZIONE ELETTRICA. ELECTRICAL FEEDING
2	UNITA' ACQUA REFRIGERANTE Ø 1/2" IN VETROLO ØD 75mm. WATER OUTLET
1	INGRESSO ACQUA REFRIGERANTE Ø 1/2" IN VETROLO ØD 75mm. WATER INLET

REVISIONE	MODIFICAZIONE	DATA	PROVA	SCALE
01	RC CONDIZIONATA	13.08.10	1	1:1
02	RC CONDIZIONATA	23.08.10	1	1:1
03	RC CONDIZIONATA	23.08.10	1	1:1
04	RC CONDIZIONATA	23.08.10	1	1:1
05	RC CONDIZIONATA	23.08.10	1	1:1
06	RC CONDIZIONATA	23.08.10	1	1:1
07	RC CONDIZIONATA	23.08.10	1	1:1
08	RC CONDIZIONATA	23.08.10	1	1:1
09	RC CONDIZIONATA	23.08.10	1	1:1
10	RC CONDIZIONATA	23.08.10	1	1:1
11	RC CONDIZIONATA	23.08.10	1	1:1
12	RC CONDIZIONATA	23.08.10	1	1:1
13	RC CONDIZIONATA	23.08.10	1	1:1
14	RC CONDIZIONATA	23.08.10	1	1:1
15	RC CONDIZIONATA	23.08.10	1	1:1
16	RC CONDIZIONATA	23.08.10	1	1:1
17	RC CONDIZIONATA	23.08.10	1	1:1
18	RC CONDIZIONATA	23.08.10	1	1:1
19	RC CONDIZIONATA	23.08.10	1	1:1
20	RC CONDIZIONATA	23.08.10	1	1:1
21	RC CONDIZIONATA	23.08.10	1	1:1
22	RC CONDIZIONATA	23.08.10	1	1:1
23	RC CONDIZIONATA	23.08.10	1	1:1
24	RC CONDIZIONATA	23.08.10	1	1:1
25	RC CONDIZIONATA	23.08.10	1	1:1
26	RC CONDIZIONATA	23.08.10	1	1:1
27	RC CONDIZIONATA	23.08.10	1	1:1
28	RC CONDIZIONATA	23.08.10	1	1:1
29	RC CONDIZIONATA	23.08.10	1	1:1
30	RC CONDIZIONATA	23.08.10	1	1:1
31	RC CONDIZIONATA	23.08.10	1	1:1
32	RC CONDIZIONATA	23.08.10	1	1:1
33	RC CONDIZIONATA	23.08.10	1	1:1
34	RC CONDIZIONATA	23.08.10	1	1:1
35	RC CONDIZIONATA	23.08.10	1	1:1
36	RC CONDIZIONATA	23.08.10	1	1:1
37	RC CONDIZIONATA	23.08.10	1	1:1
38	RC CONDIZIONATA	23.08.10	1	1:1
39	RC CONDIZIONATA	23.08.10	1	1:1
40	RC CONDIZIONATA	23.08.10	1	1:1
41	RC CONDIZIONATA	23.08.10	1	1:1
42	RC CONDIZIONATA	23.08.10	1	1:1
43	RC CONDIZIONATA	23.08.10	1	1:1
44	RC CONDIZIONATA	23.08.10	1	1:1
45	RC CONDIZIONATA	23.08.10	1	1:1
46	RC CONDIZIONATA	23.08.10	1	1:1
47	RC CONDIZIONATA	23.08.10	1	1:1
48	RC CONDIZIONATA	23.08.10	1	1:1
49	RC CONDIZIONATA	23.08.10	1	1:1
50	RC CONDIZIONATA	23.08.10	1	1:1
51	RC CONDIZIONATA	23.08.10	1	1:1
52	RC CONDIZIONATA	23.08.10	1	1:1
53	RC CONDIZIONATA	23.08.10	1	1:1
54	RC CONDIZIONATA	23.08.10	1	1:1
55	RC CONDIZIONATA	23.08.10	1	1:1
56	RC CONDIZIONATA	23.08.10	1	1:1
57	RC CONDIZIONATA	23.08.10	1	1:1
58	RC CONDIZIONATA	23.08.10	1	1:1
59	RC CONDIZIONATA	23.08.10	1	1:1
60	RC CONDIZIONATA	23.08.10	1	1:1
61	RC CONDIZIONATA	23.08.10	1	1:1
62	RC CONDIZIONATA	23.08.10	1	1:1
63	RC CONDIZIONATA	23.08.10	1	1:1
64	RC CONDIZIONATA	23.08.10	1	1:1
65	RC CONDIZIONATA	23.08.10	1	1:1
66	RC CONDIZIONATA	23.08.10	1	1:1
67	RC CONDIZIONATA	23.08.10	1	1:1
68	RC CONDIZIONATA	23.08.10	1	1:1
69	RC CONDIZIONATA	23.08.10	1	1:1
70	RC CONDIZIONATA	23.08.10	1	1:1
71	RC CONDIZIONATA	23.08.10	1	1:1
72	RC CONDIZIONATA	23.08.10	1	1:1
73	RC CONDIZIONATA	23.08.10	1	1:1
74	RC CONDIZIONATA	23.08.10	1	1:1
75	RC CONDIZIONATA	23.08.10	1	1:1
76	RC CONDIZIONATA	23.08.10	1	1:1
77	RC CONDIZIONATA	23.08.10	1	1:1
78	RC CONDIZIONATA	23.08.10	1	1:1
79	RC CONDIZIONATA	23.08.10	1	1:1
80	RC CONDIZIONATA	23.08.10	1	1:1
81	RC CONDIZIONATA	23.08.10	1	1:1
82	RC CONDIZIONATA	23.08.10	1	1:1
83	RC CONDIZIONATA	23.08.10	1	1:1
84	RC CONDIZIONATA	23.08.10	1	1:1
85	RC CONDIZIONATA	23.08.10	1	1:1
86	RC CONDIZIONATA	23.08.10	1	1:1
87	RC CONDIZIONATA	23.08.10	1	1:1
88	RC CONDIZIONATA	23.08.10	1	1:1
89	RC CONDIZIONATA	23.08.10	1	1:1
90	RC CONDIZIONATA	23.08.10	1	1:1
91	RC CONDIZIONATA	23.08.10	1	1:1
92	RC CONDIZIONATA	23.08.10	1	1:1
93	RC CONDIZIONATA	23.08.10	1	1:1
94	RC CONDIZIONATA	23.08.10	1	1:1
95	RC CONDIZIONATA	23.08.10	1	1:1
96	RC CONDIZIONATA	23.08.10	1	1:1
97	RC CONDIZIONATA	23.08.10	1	1:1
98	RC CONDIZIONATA	23.08.10	1	1:1
99	RC CONDIZIONATA	23.08.10	1	1:1
100	RC CONDIZIONATA	23.08.10	1	1:1

**MACHINE DRAWINGS**  
Dimensions in mm

SIZE U7 D



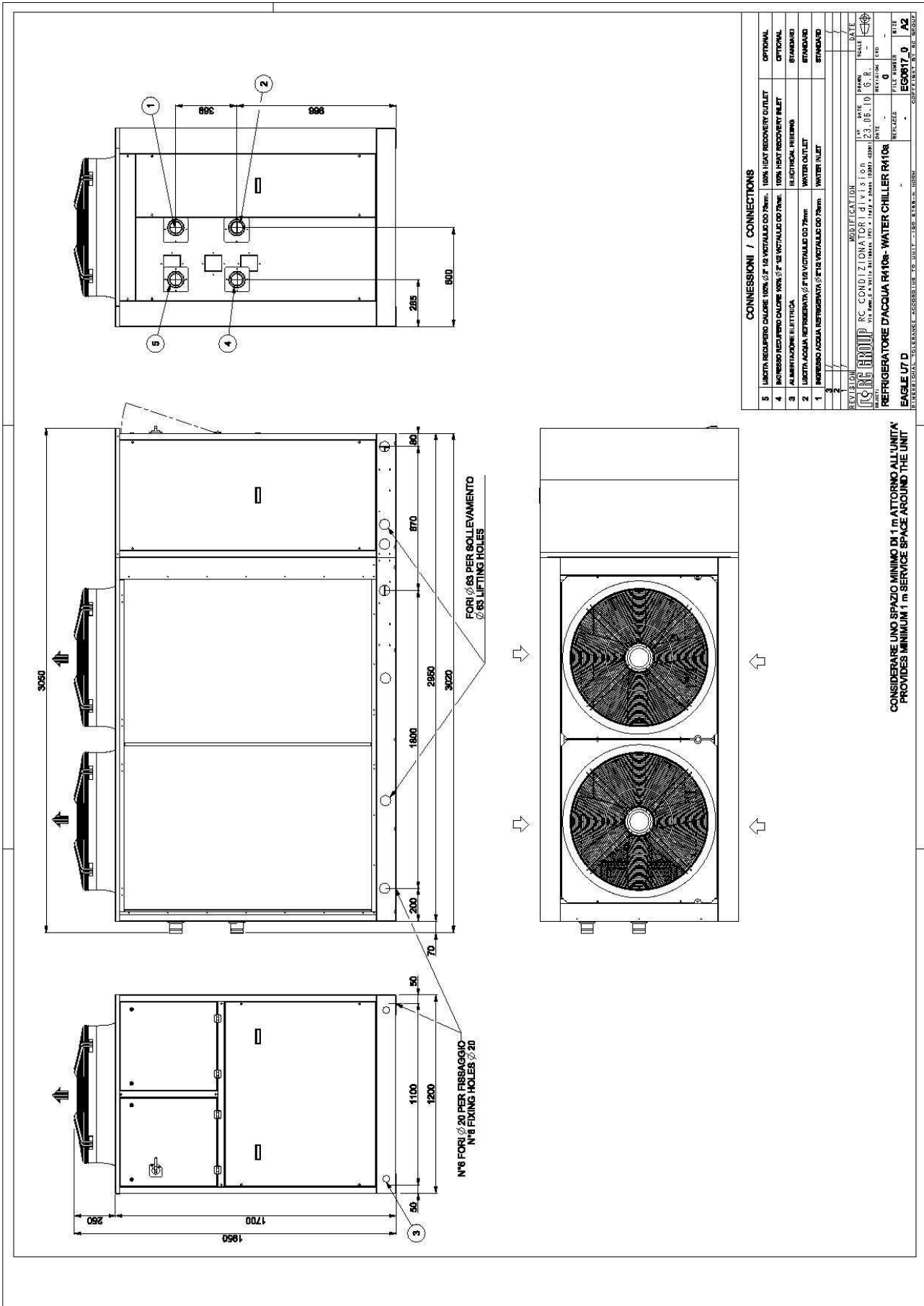

**MACHINE DRAWINGS**  
Dimensions in mm

SIZE U8L D mod. T 150 P2

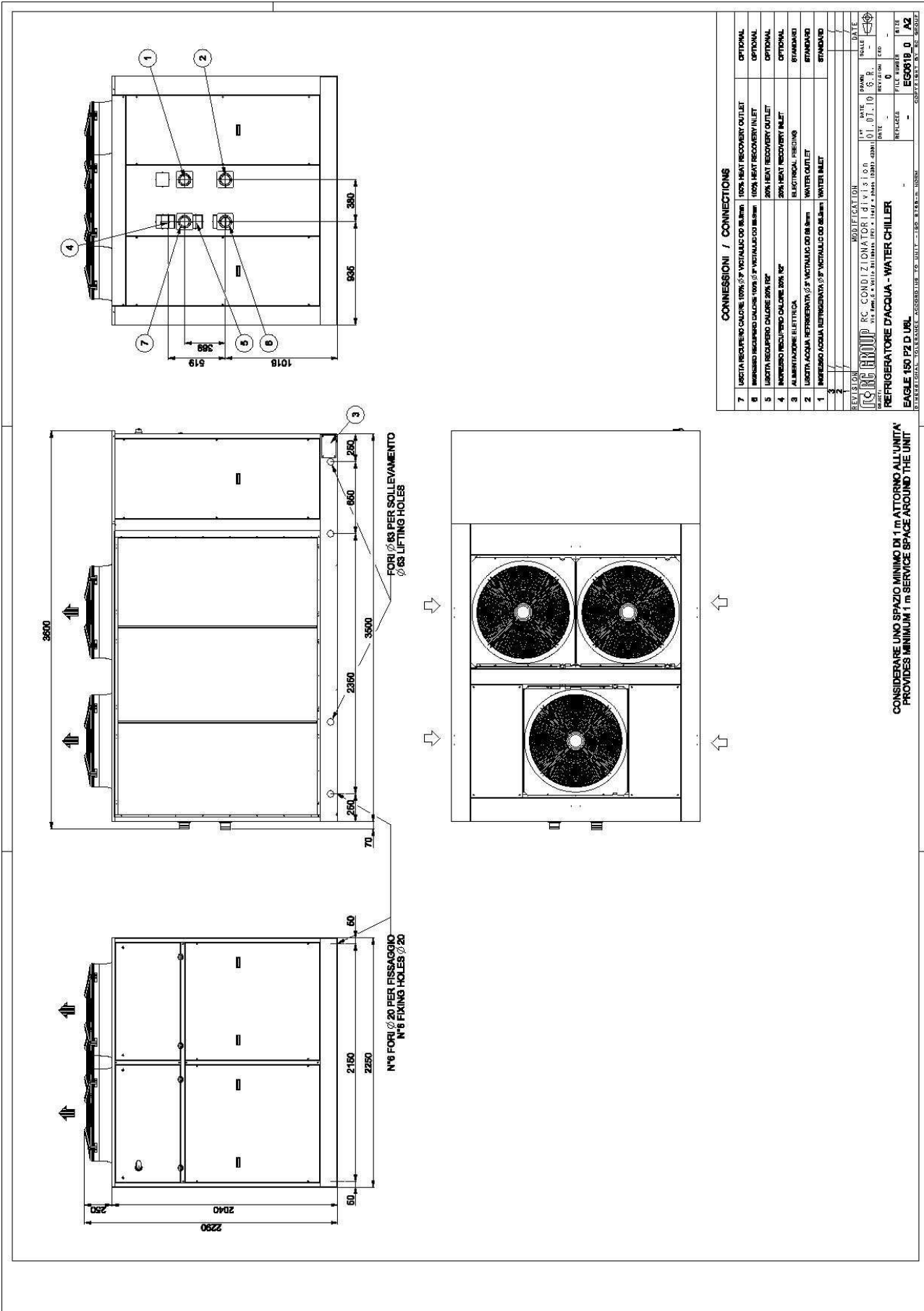

**MACHINE DRAWINGS**  
Dimensions in mm

SIZE U8L D mod. T 170 P4

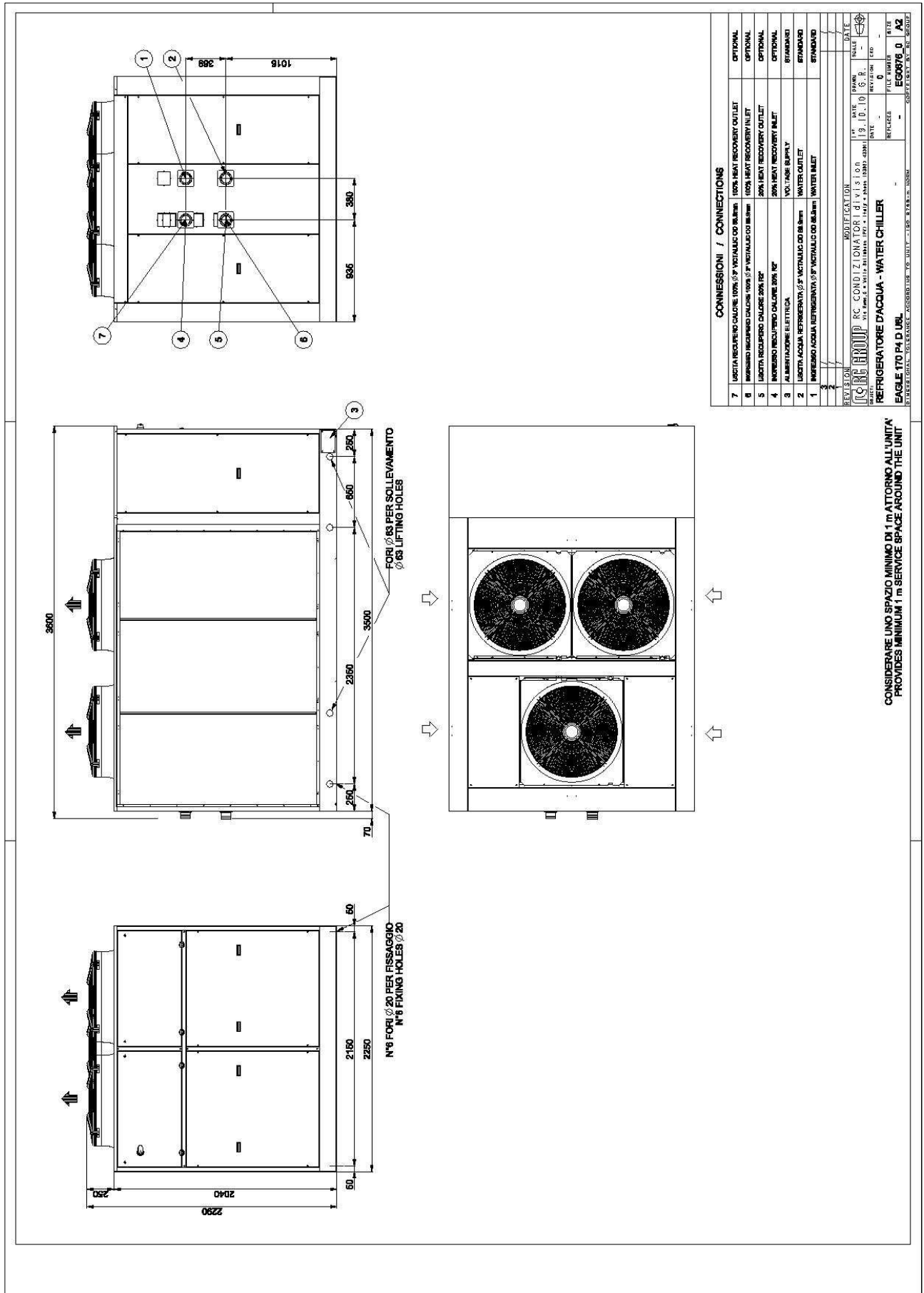

**MACHINE DRAWINGS**  
Dimensions in mm

SIZE U8L S mod. T 175 P3

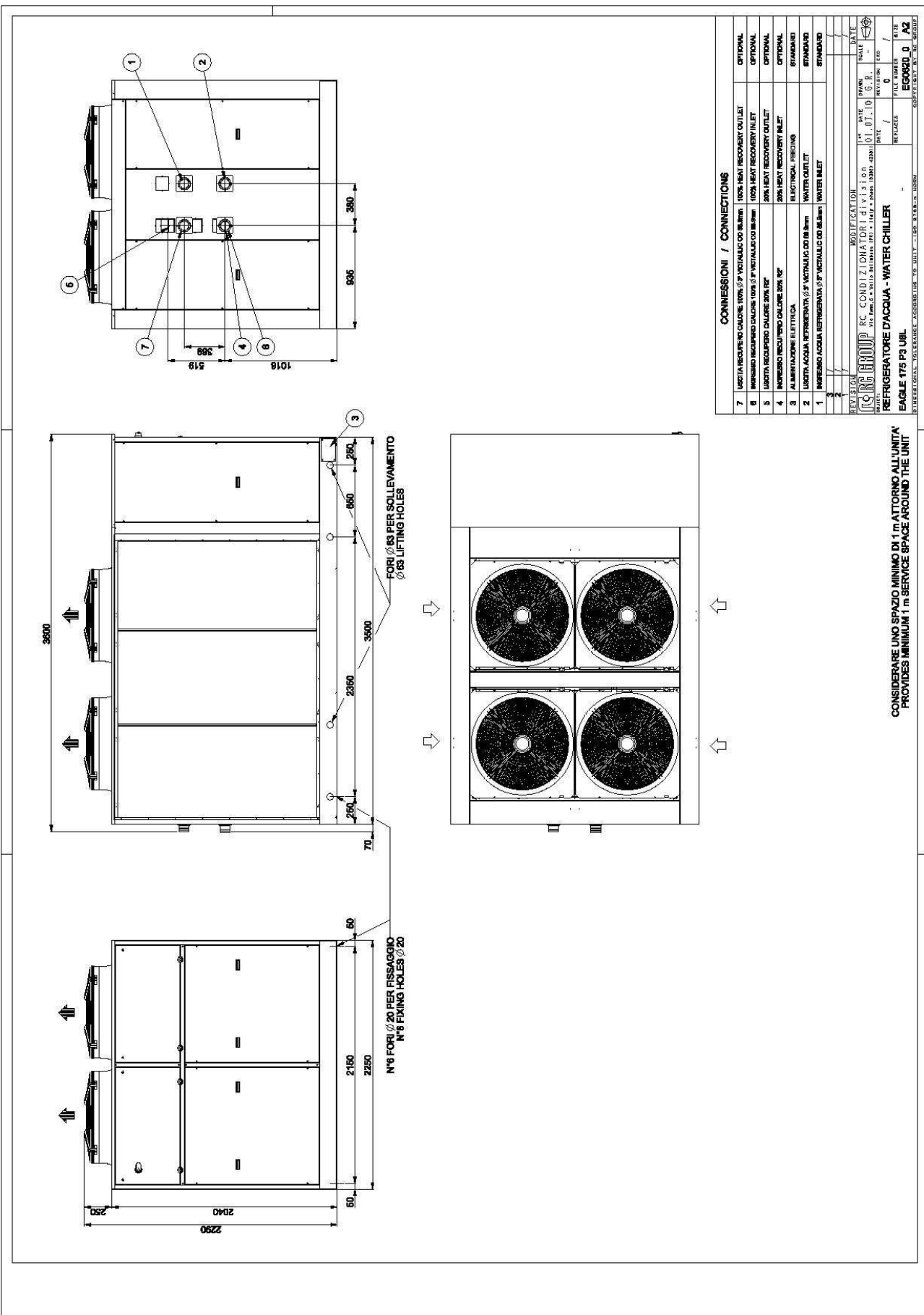

**CONNESSIONI / CONNECTIONS**

7	USCITA RISCALDAMENTO CALORE 100% Ø 2" VITALLICO Ø 0.8 in. (mm)	100% HEAT RECOVERY OUTLET	OPTIONAL
8	INGRESSO RISCALDAMENTO CALORE 100% Ø 2" VITALLICO Ø 0.8 in. (mm)	100% HEAT RECOVERY INLET	OPTIONAL
5	USCITA RISCALDAMENTO CALORE 20% Ø 2" VITALLICO Ø 0.8 in. (mm)	20% HEAT RECOVERY OUTLET	OPTIONAL
4	INGRESSO RISCALDAMENTO CALORE 20% Ø 2" VITALLICO Ø 0.8 in. (mm)	20% HEAT RECOVERY INLET	OPTIONAL
3	ALIMENTAZIONE ELETTRICA	ELECTRICAL FEEDING	STANDARD
2	USCITA ACQUA REFRIGERATA Ø 2" VITALLICO Ø 0.8 in. (mm)	WATER OUTLET	STANDARD
1	INGRESSO ACQUA REFRIGERATA Ø 2" VITALLICO Ø 0.8 in. (mm)	WATER INLET	STANDARD
6			

**REVISIONI**

REVISIONI	MODIFICAZIONI	DATA	DATA
0	RC CONDIZIONATORI divisione	01.01.10	01.01.10
1	REVISIONI		
2	REVISIONI		

**RC GROUP**  
REFRIGERATORE D'ACQUA - WATER CHILLER  
EAGLE ITS P3 U8L

STABILIMENTO: VIA S. GIUSEPPE, 10 - 20147 - TORINO - ITALY  
 TELEFONO: +39 011 26 26 26  
 FAX: +39 011 26 26 26  
 E-MAIL: eagle@rcgroup.it  
 WWW: www.rcgroup.it

CONSIDERARE UNO SPAZIO MINIMO DI 1 m ATTORNO ALL'UNITA'  
PROVIDES MINIMUM 1 m SERVICE SPACE AROUND THE UNIT

**MACHINE DRAWINGS**  
Dimensions in mm

SIZE U8L D mod. T 190 P4

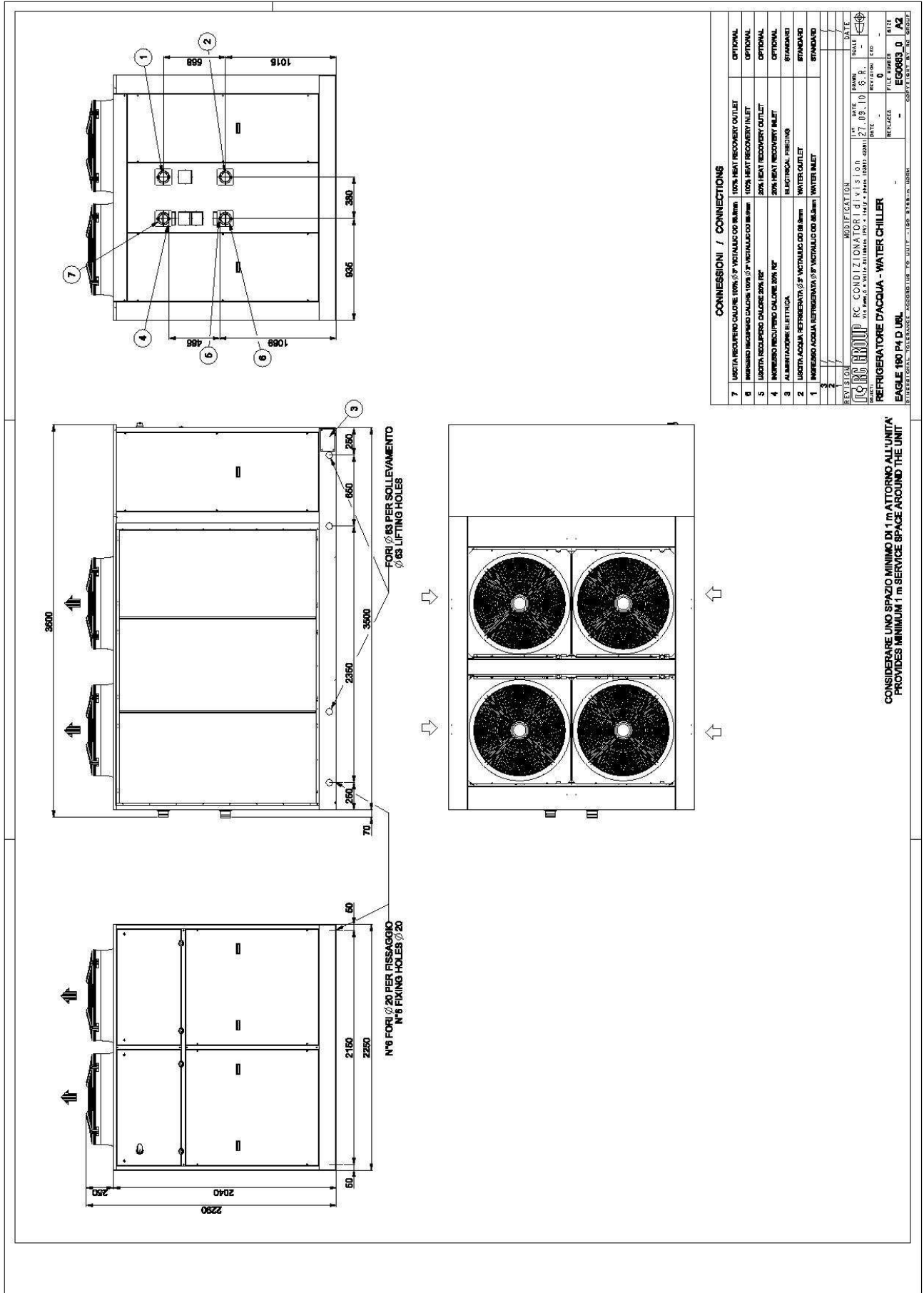

**MACHINE DRAWINGS**  
Dimensions in mm

SIZE U8L S mod. T 200 P2

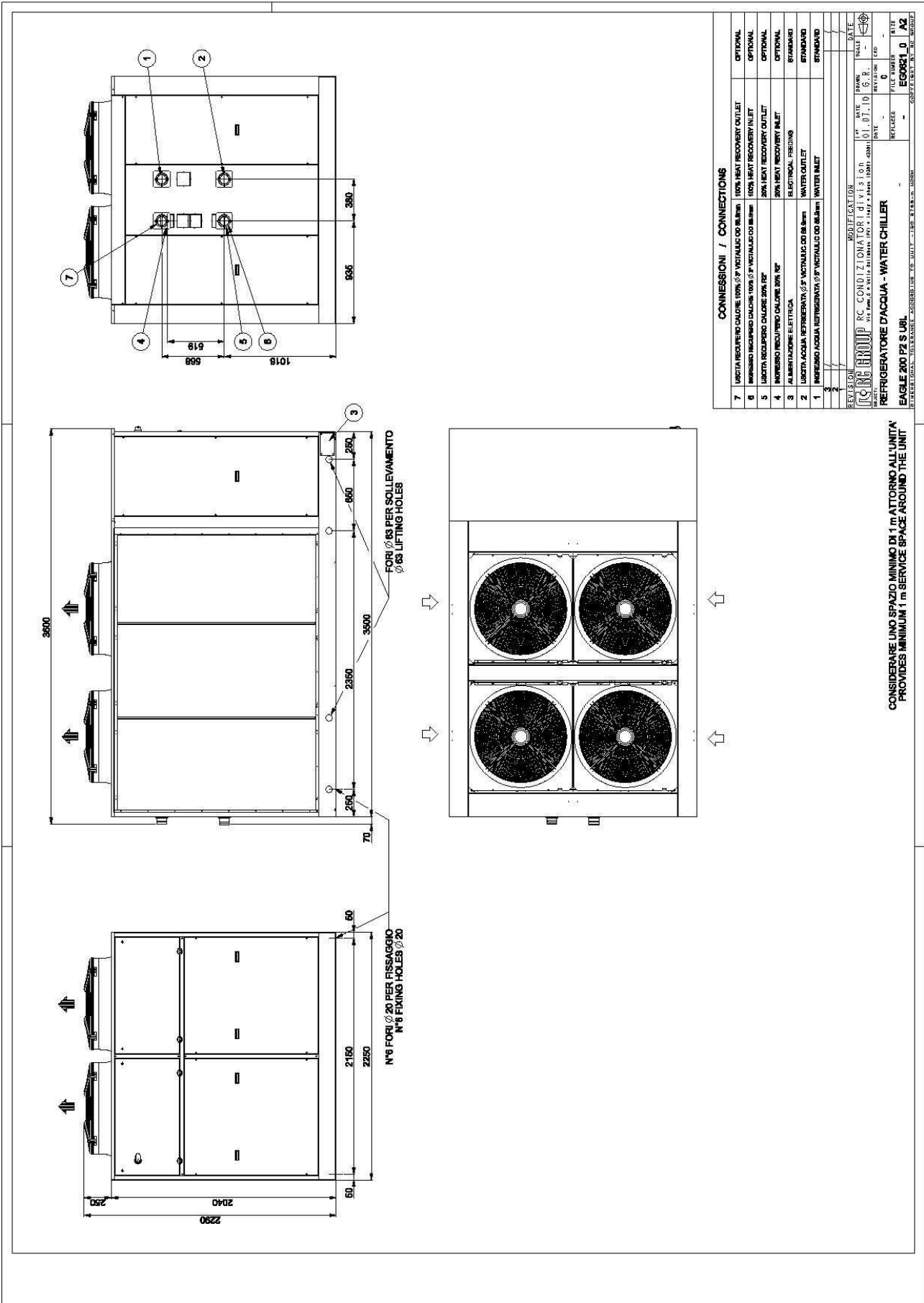

**MACHINE DRAWINGS**  
Dimensions in mm

SIZE U8L D mod. T 200 P2

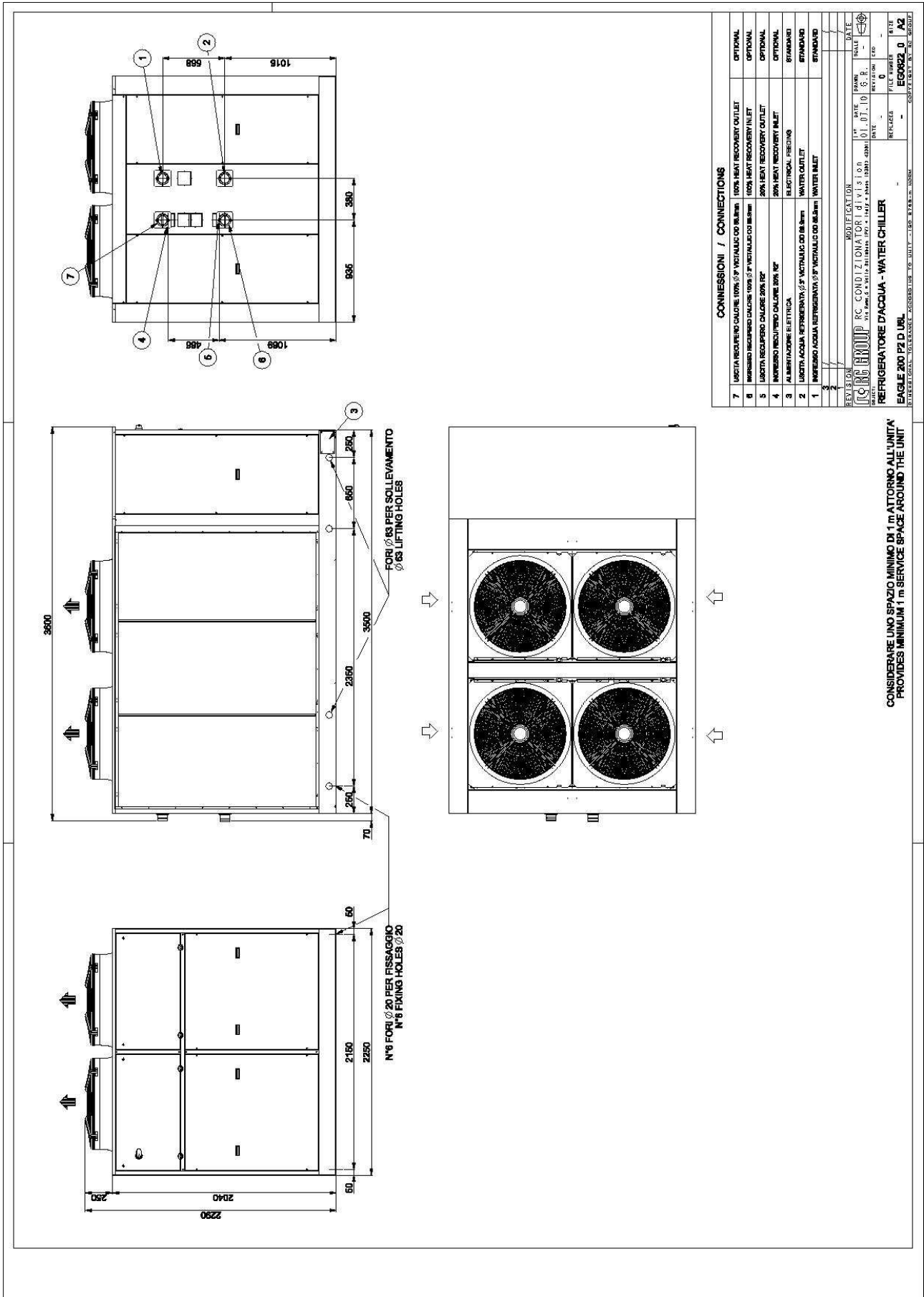

**MACHINE DRAWINGS**  
Dimensions in mm

**SIZE U8L S mod. T 220 P3**

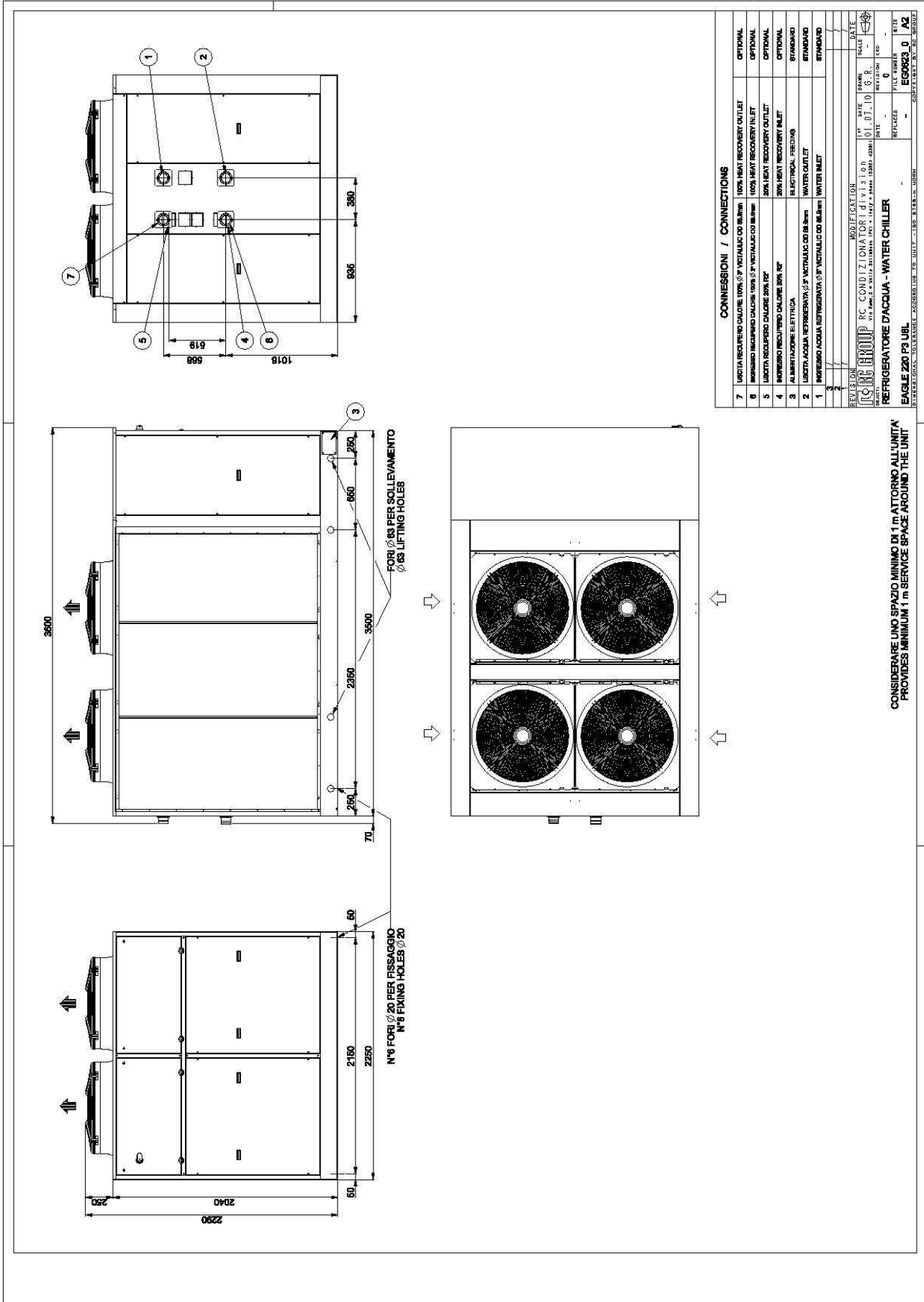

**MACHINE DRAWINGS**  
Dimensions in mm

SIZE U9L S mod. T 290 P3

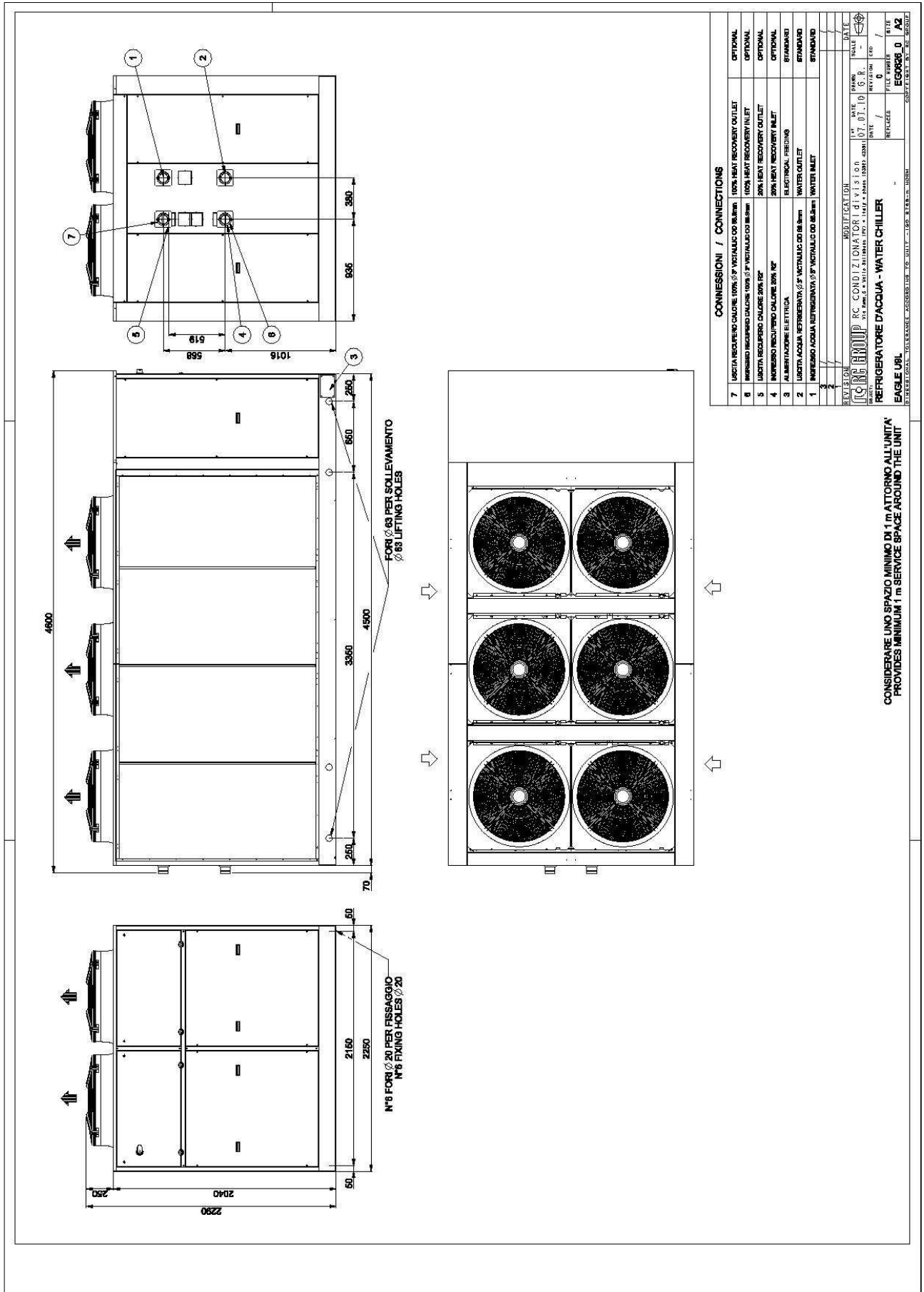











**MACHINE DRAWINGS**  
Dimensions in mm

SIZE Y4 D mod. T 570 P6

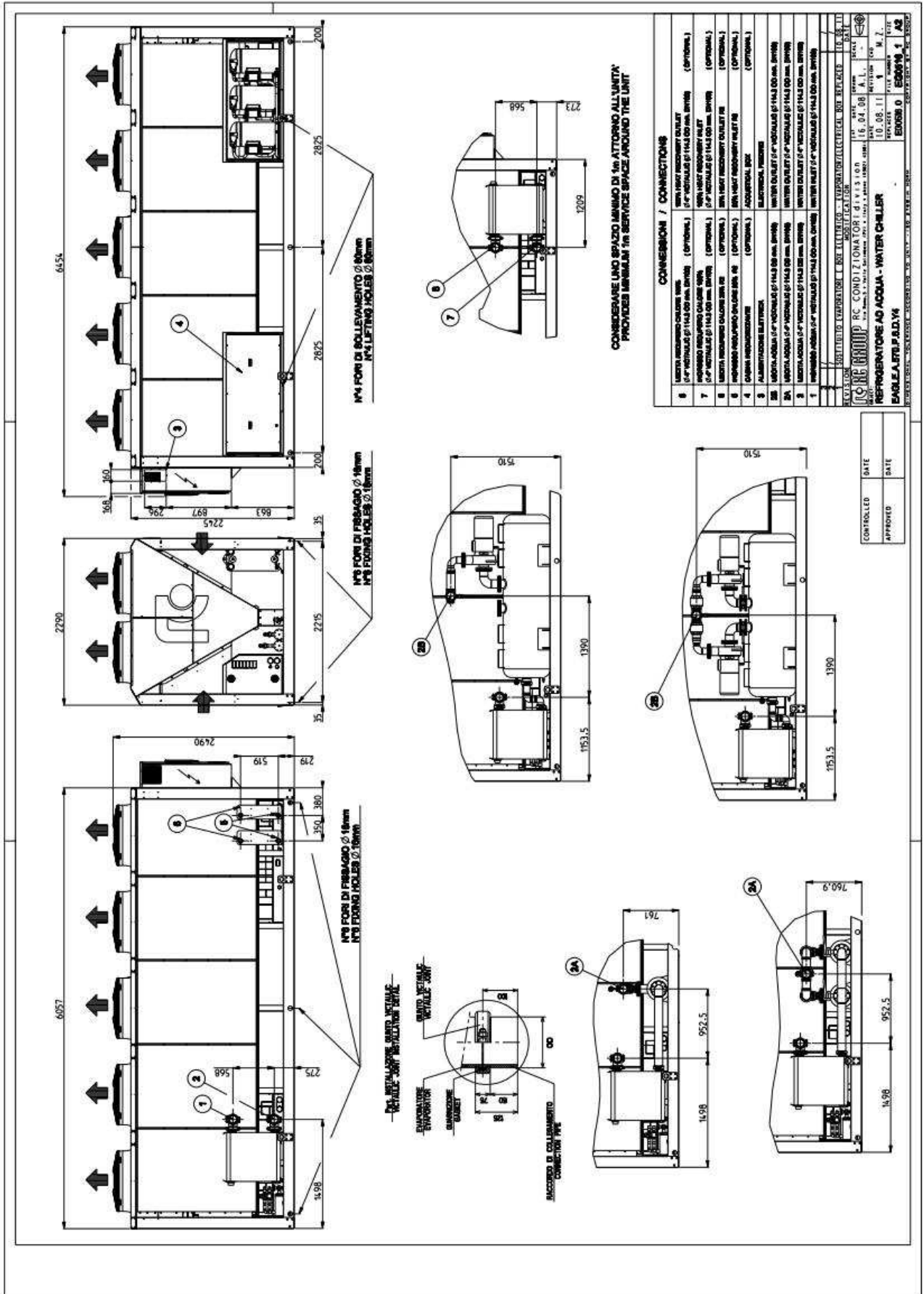





The continuous improvement of products may imply changes in the data shown in this catalogue.



RC GROUP S.p.A. • Via Roma, 5 • 27010 Valle Salimbene (PV), Italy  
www.rcgroup.it • Tel. +39 (0) 382 433 811 • Fax +39 (0) 382 587 148

T\_EGL\_1012\_GB