

R410A **smart**

4,9 ÷ 49,5 kW

Air cooled liquid chillers and heat pumps
equipped with scroll compressor and axial fans



INDEX

SERIES IDENTIFICATION	3
MODEL IDENTIFICATION.....	3
“CE” CONFORMITY	3
WORKING LIMITS.....	4
COMPONENTS	6
COMMON OPTIONAL ACCESSORIES	7
TECHNICAL DATA - SMART – LIQUID CHILLER	8
TECHNICAL DATA – SMART.HP – HEAT PUMP.....	10
ACOUSTIC DATA.....	12
ELECTRIC DATA	12
MINIMUM PLANT WATER CONTENT	12
MICROPROCESSOR CONTROL SYSTEM.....	13
REMOTE COMMAND / ALARMS.....	13
PUMPING GROUP	14
OPTIONAL ACCESSORIES – METALLIC MESH FILTER KIT	16
OPTIONAL ACCESSORIES – ADDITIONAL WATER PUMP	19
OPTIONAL ACCESSORIES – REMOTE CONTROL PANEL KIT.....	20
ST500” RC-COM MBUS/JBUS SERIAL INTERFACE KIT	21
UNIT DRAWINGS.....	22

SERIES IDENTIFICATION

SMART - Air cooled liquid chillers and heat pumps with one condensing coil in vertical position and equipped with scroll compressor, axial fans, welded plate heat exchangers and chilled water pump. Horizontal air suction and discharge.

SMART 5÷9 - Liquid chiller

Cooling capacity 4,9 ÷ 8,7 kW

SMART.HP 5÷9 - Heat pump

Cooling capacity 4,6 ÷ 8,2 kW

Heating capacity 5,7 ÷ 9,6 kW



SMART 11 ÷ 49 - Liquid chiller

Cooling capacity 11,4 ÷ 49,5 kW

SMART.HP 11 ÷ 49 - Heat pump

Cooling capacity 10,4 ÷ 48,7 kW

Heating capacity 12,3 ÷ 57,0 kW

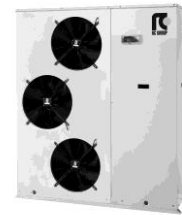

MODEL IDENTIFICATION

SMART HP M 6

A Condenser fan type

A Axial fan

HP Heat pump version

M Power supply

M Single-phase 230/150

T Three-phase 400/3/50+N

6 Cooling capacity (kW)

“CE” CONFORMITY

The units are in compliance with CE 98/37, 2004/108/CE, CE 97/23, 2006/95/CE European norms and subsequent modifications.

WORKING LIMITS

COOLING – chilled water production

Working limits diagram for chilled water production according to the ambient temperature and chilled water outlet temperature.

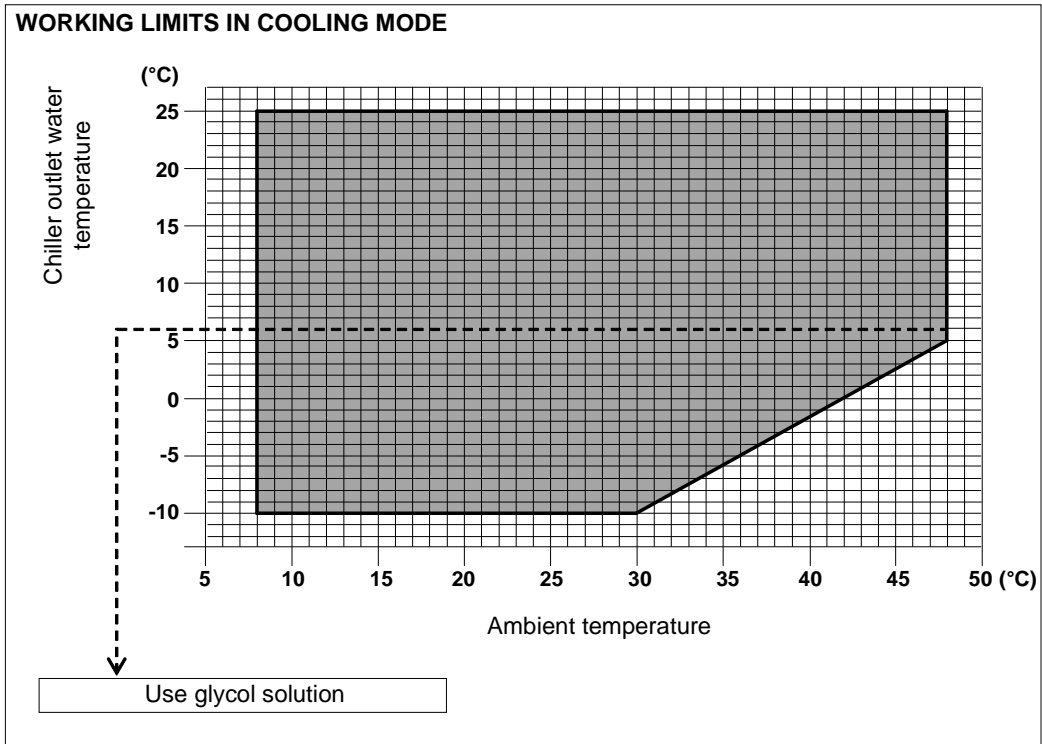

CONDENSING CONTROL

Condensing control with phase-cut electronic regulators

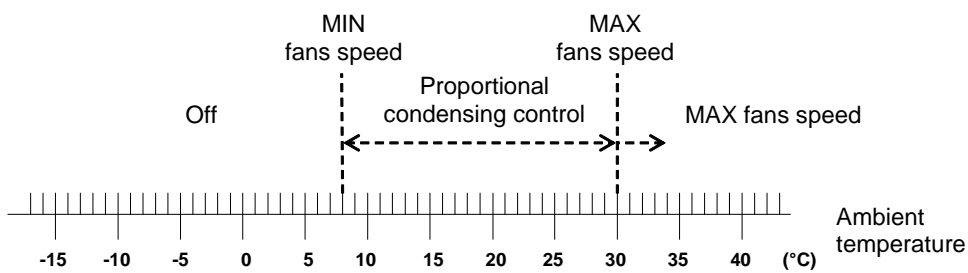

The values are indicative. The working temperatures are influenced by a series of variables as:

- Working conditions
- Thermal load
- Active capacity steps
- Cleanness status of the condensing coils
- Set of the microprocessor control

HEATING – hot water production for heating (Heat pump)

Working limits diagram for hot water production according to the ambient temperature and hot water outlet temperature for SMART HP series.

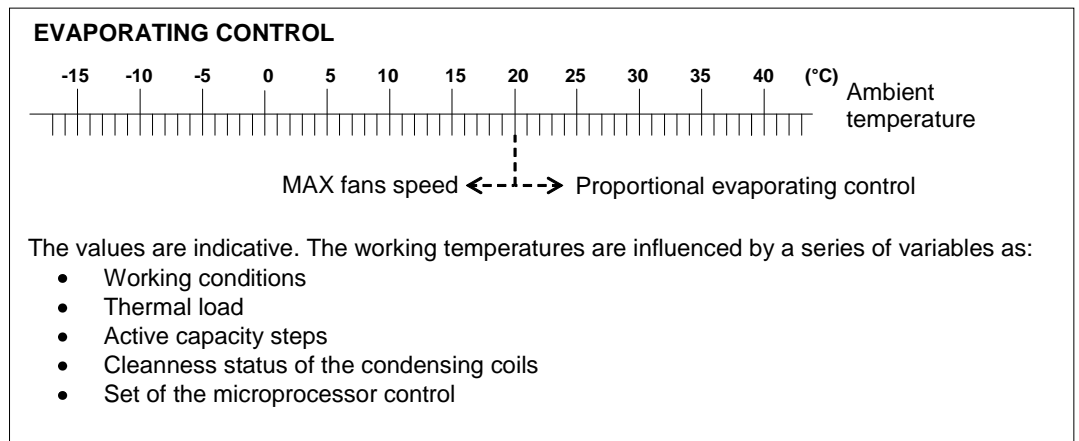
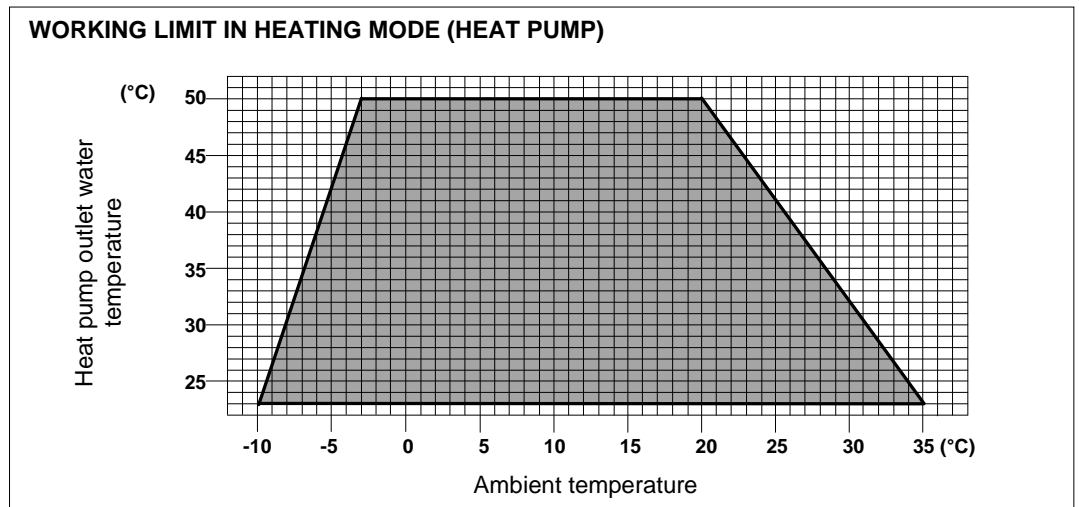

ANTIFREEZE MIXTURES

Antifreeze mixtures has to be used when the machine working conditions foresees the chilled outlet liquid temperature as shown in the table:

PROPYLENE GLYCOL

Chilled outlet liquid temperature from the machine	°C	4	2	1	-2	-4	-6	-9	-12	-14	-16
Percentage in weight of the mixture	%	5	10	15	20	25	30	35	40	45	50

ETHYLENE GLYCOL

Chilled outlet liquid temperature from the machine	°C	4	2	0	-4	-7	-9	-10	-13	-16	-18
Percentage in weight of the mixture	%	5	10	15	20	25	30	35	40	45	50

WARNING

The values are referred to machine working temperature and not to freezing temperature of the used liquid.

The use of antifreeze mixtures causes a reduction of the machine performance,

Please refer to the RC WORLD electronic catalogue to obtain the effective performance.

STORING TEMPERATURE: -30 ÷ 63°C in absence of superficial condensation and direct sun light.

COMPONENTS

- Housing and unit base made of RAL9002 epoxy painted galvanized steel sheet.
- Technical compartment, fully enclosed and separate from the air flow, housing compressors, evaporator, controls, electric and regulation devices, to assure working continuity during ordinary service and preventive maintenance operations and to reduce the noise emissions.
- Scroll type fully-hermetic compressor with built-in electric protection.
- Crankcase electric heater.
- Rubber holders for compressor.
- Stainless steel AISI 316 welded plate evaporator, insulated with polyurethane.
- Antifreeze electric heater for evaporator.
- Condensing coil with copper tubes, continuous aluminium finning and frame in non-oxidable material.
- Condensing coil protection net (for models 5 / 6 / 7 / 9 / 11 / 13 / 15)
- Axial fans directly coupled to electric motor with built-in thermal protection and protected by special safety net.
- Condensing control system by stepless condenser fans speed.
- Differential pressure switch for water flow loss control.
- Cooling circuit components:
 - Thermostatic expansion valve with external equalizer.
 - Liquid and moisture indicator (for models 11 / 13 / 15 / 19 / 22 / 26 / 33 / 35 / 40 / 49) .
 - High pressure safety switch.
 - Low pressure safety switch.
 - Pressure transducer for condensing/evaporating control.
 - Dryer and anti-acid gas filter.
 - Copper piping for refrigerant circuit.
 - R410A refrigerant gas and non-freezing oil charge.
- Microprocessor control system.
- Temperature sensors on evaporator water inlet/outlet.
- Pumping group including:
 - Water pump
 - Pressure gauge
 - Expansion tank
 - Safety valve
- Electric box built-in the unit housing, suitable for outdoor installation, including:
 - SMART / SMART.HP – 230/1/50 – Models 5 / 6 / 7 / 9 / 11.
 - Electric box according to IEC 204-1/EN60335-2-40 norms
 - Contactor for compressor.
 - Electronic card for water pump control
 - Auxiliary relays
 - Microprocessor control
 - Auxiliary circuit and microprocessor feeding by transformer.
 - Remote command/signal: On/off switch, general alarm signal, remote keyboard, water flow switch, compressor on signal, summer/winter selector for heat pump version.
 - SMART / SMART.HP – 400/3/50+N – Models 6 / 7 / 9 / 11 / 13 / 15.
 - Electric box according to IEC 204-1/EN60335-2-40 norms
 - Contactor for compressor.
 - Electronic card for water pump control
 - Auxiliary relays
 - Microprocessor control
 - Auxiliary circuit and microprocessor feeding by transformer.
 - Remote command/signal: On/off switch, general alarm signal, remote keyboard, water flow switch, compressor on signal, summer/winter selector for heat pump version.

- SMART / SMART.HP – 400/3/50+N – Models 19 / 22 / 26 / 33 / 35 / 40 / 49.
 - o Electric box according to IEC 204-1/EN60204-1 norms
 - o Main switch with door lock safety
 - o Magnetothermic switch for compressor
 - o Contactor for compressor.
 - o Electronic card for water pump control
 - o Electronic card for condenser fan control
 - o Auxiliary relays
 - o Phases monitoring relay
 - o Microprocessor control
 - o Auxiliary circuit and microprocessor feeding by transformer.
 - o Remote command/signal: On/off switch, general alarm signal, remote keyboard, water flow switch, compressor on signal, summer/winter selector for heat pump version.

HEAT PUMP COMPONENTS

- Microprocessor controlled automatic defrosting system of the gas/air heat exchanger.
- Cycle inversion valve.
- Liquid receiver.
- Non return valve.
- Double thermostatic expansion valve.
- Condensate tray with discharge predisposition (excluded models 19 / 22 / 26 / 33)

COMMON OPTIONAL ACCESSORIES

- Kit for condensing coil protection net (for models 19 / 22 / 26 / 33 / 35 / 40 / 49).
- Kit for unit rubber antivibration holders.
- Kit for storage tank (for models 5 / 6 / 7 / 9 / 11 / 13 / 15 / 19 / 22 / 26 / 33)
- Kit for tank connection pipe (for models 5 / 6 / 7 / 9 / 11 / 13 / 15 / 19 / 22 / 26 / 33)
- Kit for additional water pump (for models 11 / 13 / 15).
- Kit for metallic filter on hydraulic circuit.
- Kit for condensate tray for SMART.HP version (for models 19 / 22 / 26 / 33). The optional has to be installed together the chiller.
- RCom MBUS / JBUS serial port (for models 35 / 40 / 49)
- Microprocessor accessories:
 - Kit for remote control: remote panel for unit control and alarms signalling.

WARNING

It is compulsory to install a water filter on evaporator water inlet.

The optional named “Kit” are not factory installed. The installation is at Customer care.

RC GROUP reserves the right to accept the matching of the optional installed on the unit.

TECHNICAL DATA - SMART – Liquid chiller

MODEL		M.5	M.6	M.7	M.9	M.11	T.6	T.7	T.9	T.11
COOLING ONLY (1)										
COOLING CAPACITY	kW	4,9	5,6	6,9	8,6	11,4	5,6	7,0	8,7	11,4
Compressor power input	kW	1,8	1,9	2,4	3,3	3,9	1,9	2,3	3,0	3,9
Compressor absorbed current	A	8,6	9,2	11,8	15,0	7,1	3,6	3,8	5,3	7,1
Evaporator water flow rate	m ³ /h	0,9	0,96	1,19	1,48	1,96	0,96	1,20	1,50	1,96
Evaporator pressure drop	kPa	22	23	28	31	34	23	29	32	34
COMPRESSOR		scroll	scroll	scroll	scroll	scroll	scroll	scroll	scroll	scroll
Quantity	n.	1	1	1	1	1	1	1	1	1
Max operating current FLA	A	16,0	16,0	19,0	23,0	30,0	5,5	6,0	8,0	10,0
Starting current LRA	A	58	61	82	97	130	32	35	48	64
Capacity steps	n.	1	1	1	1	1	1	1	1	1
EVAPORATOR		n.	1	1	1	1	1	1	1	1
Water volume	l	1,0	1,3	1,4	1,7	1,7	1,3	1,4	1,7	1,7
Max water flow rate	m ³ /h	1,3	1,4	1,8	2,2	2,8	1,4	1,8	2,3	2,9
AXIAL FANS		n.	1	1	1	2	1	1	1	2
Total air flow	m ³ /h	2400	3500	3500	4200	6800	3500	3500	4200	6800
Total power input	kW	0,10	0,14	0,14	0,17	0,28	0,14	0,14	0,17	0,28
Max operating current FLA	A	0,98	0,98	0,98	0,98	1,96	0,98	0,98	0,98	1,96
REFRIGERANT		R410A	R410A	R410A	R410A	R410A	R410A	R410A	R410A	R410A
Total refrigerant charge	kg	1,35	1,70	2,65	2,35	2,35	1,70	2,65	2,35	2,35
Gas circuits	n.	1	1	1	1	1	1	1	1	1
POWER SUPPLY		V/Ph/Hz	230/1/50				400/3/50+N			
ENERGY EFFICIENCY INDEXES										
EER - Energy Efficiency Ratio	kW/kW	2,58	2,75	2,72	2,48	2,73	2,75	2,87	2,74	2,73
IPLV - ARI Standard 550/590		3,18	3,37	3,34	3,05	3,32	3,37	3,53	3,38	3,36
ESEER Eurovent Standard		3,60	3,81	3,77	3,44	3,75	3,81	3,98	3,81	3,80
SOUND LEVEL - ISO 3744 (2)										
Sound pressure level (Lp)	dB(A)	50,1	55,1	55,1	55,1	58,0	55,1	55,1	55,1	58,0
Sound power level (Lw)	dB(A)	64,0	68,9	69,5	69,5	72,8	68,9	69,5	69,5	72,8
PUMPING GROUP										
Power input	kW	0,22	0,22	0,22	0,22	0,22	0,22	0,22	0,22	0,22
Absorbed current	A	0,92	0,92	0,92	0,92	0,92	0,92	0,92	0,92	0,92
DIMENSIONS										
Length	mm	900	900	900	900	900	900	900	900	900
Width	mm	370	370	370	370	370	370	370	370	370
Height	mm	640	640	940	940	1240	640	940	940	1240
NET WEIGHT	kg	80	85	100	105	125	85	100	105	125
HYDRAULIC CONNECTIONS										
EVAPORATOR										
Inlet/Outlet - ISO228/1-G M	Ø	3/4"	3/4"	3/4"	3/4"	1 1/4"	1 1/4"	1 1/4"	1 1/4"	1 1/4"

1. Referred to chiller water temperature 12/7°C; 35°C ambient temperature.
2. Sound level 1m far in free field conditions – condenser fan side.

TECHNICAL DATA - SMART – Liquid chiller

MODEL		T.13	T.15	T.19	T.22	T.26	T.33	T.35	T.40	T.49
COOLING ONLY (1)										
COOLING CAPACITY	kW	13,2	15,4	19,3	21,9	26,4	32,9	34,7	39,7	49,5
Compressor power input	kW	4,4	4,9	6,2	7,2	7,5	9,9	9,6	11,8	15,8
Compressor absorbed current	A	7,7	8,4	11,1	12,3	14,7	17,6	17,4	22,3	27,4
Evaporator water flow rate	m ³ /h	2,27	2,65	3,32	3,77	4,54	5,67	5,96	6,83	8,51
Evaporator pressure drop	kPa	37	35	40	36	42	42	38	39	43
COMPRESSOR		scroll	scroll	scroll	scroll	scroll	scroll	scroll	scroll	scroll
Quantity	n.	1	1	1	1	1	1	1	1	1
Max operating current FLA	A	11,8	15,0	16,0	21,0	22,0	27,0	27,0	34,0	40,0
Starting current LRA	A	64	74	95	111	118	140	140	174	225
Capacity steps	n.	1	1	1	1	1	1	1	1	1
EVAPORATOR	n.	1	1	1	1	1	1	1	1	1
Water volume	l	1,9	2,3	2,7	3,2	2,6	4,6	5,3	6,0	7,8
Max water flow rate	m ³ /h	3,4	4,0	5,0	5,7	6,8	8,5	8,9	10,2	12,8
AXIAL FANS	n.	2	2	2	2	3	3	2	2	2
Total air flow	m ³ /h	6800	6400	7000	7000	10500	10500	14000	16000	19000
Total power input	kW	0,28	0,26	0,28	0,28	0,43	0,43	0,84	0,96	1,12
Max operating current FLA	A	1,96	1,96	1,96	1,96	2,94	2,94	5,60	5,60	5,60
REFRIGERANT		R410A	R410A	R410A	R410A	R410A	R410A	R410A	R410A	R410A
Total refrigerant charge	kg	3,25	3,75	4,20	4,80	5,90	6,00	6,90	7,20	7,90
Gas circuits	n.	1	1	1	1	1	1	1	1	1
POWER SUPPLY	V/Ph/Hz	400/3/50+N								
ENERGY EFFICIENCY INDEXES										
EER - Energy Efficiency Ratio	kW/kW	2,82	2,98	2,98	2,93	3,33	3,18	3,32	3,11	2,93
IPLV - ARI Standard 550/590		3,48	3,67	3,66	3,60	4,10	3,92	4,08	3,82	3,60
ESEER Eurovent Standard		3,93	4,15	4,14	4,07	4,63	4,43	4,61	4,31	4,07
SOUND LEVEL - ISO 3744 (2)										
Sound pressure level (Lp)	dB(A)	58,0	58,2	63,0	63,1	62,1	62,1	64,3	65,1	69,1
Sound power level (Lw)	dB(A)	72,8	73,3	78,5	78,6	77,5	77,5	80,4	81,3	85,5
PUMPING GROUP										
Power input	kW	0,22	0,22	0,55	0,55	0,55	0,55	0,55	0,55	0,75
Absorbed current	A	0,92	0,92	3,80	3,80	3,80	3,80	3,80	3,80	4,80
DIMENSIONS										
Length	mm	900	900	1450	1450	1450	1450	1508	1508	1758
Width	mm	370	420	550	550	550	550	613	613	613
Height	mm	1240	1390	1200	1200	1700	1700	1700	1700	1700
NET WEIGHT	kg	145	155	245	250	320	325	335	340	420
HYDRAULIC CONNECTIONS										
EVAPORATOR										
Inlet/Outlet - ISO228/1-G M	Ø	1 1/4"	1 1/4"	1 1/4"	1 1/4"	1 1/4"	1 1/4"	1 1/2"	1 1/2"	1 1/2"

1. Referred to chiller water temperature 12/7°C; 35°C ambient temperature.
2. Sound level 1m far in free field conditions – condenser fan side.

TECHNICAL DATA – SMART.HP – Heat pump

MODEL		M.5	M.6	M.7	M.9	M.11	T.6	T.7	T.9	T.11	
SUMMER WORKING MODE (1)											
COOLING CAPACITY	kW	4,6	5,4	6,6	8,2	10,4	5,3	6,7	8,2	10,8	
Compressor power input	kW	1,8	1,9	2,4	3,3	3,8	1,9	2,3	3,0	3,9	
Compressor operating current	A	8,6	9,2	11,8	15,5	18,0	3,6	3,8	5,3	7,1	
Plant exchanger water flow rate	m ³ /h	0,79	0,93	1,13	1,41	1,79	0,91	1,15	1,41	1,86	
Plant exchanger pressure drop	kPa	20	21	26	29	29	20	27	29	31	
WINTER WORKING MODE (2)											
HEATING CAPACITY	kW	5,7	6,5	8,0	9,9	12,3	6,4	7,9	9,6	12,7	
Compressor power input	kW	2,2	2,2	2,8	3,5	4,3	2,2	2,6	3,1	4,5	
Compressor operating current	A	10,2	10,7	13,5	15,7	20,0	4,2	4,4	5,5	8,1	
COMPRESSOR		scroll	scroll	scroll	scroll	scroll	scroll	scroll	scroll	scroll	
Quantity	n.	1	1	1	1	1	1	1	1	1	
Max operating current FLA	A	16,0	16,0	19,0	23,0	30,0	5,5	6,0	8,0	10,0	
Starting current LRA	A	58	61	82	97	130	32	35	48	64	
Capacity steps	n.	1	1	1	1	1	1	1	1	1	
PLANT WATER EXCHANGER	n.	1	1	1	1	1	1	1	1	1	
Water volume	l	1,0	1,3	1,4	1,7	1,7	1,3	1,4	1,7	1,7	
Max water flow rate	m ³ /h	1,2	1,4	1,7	2,1	2,7	1,4	1,7	2,1	2,8	
AXIAL FANS	n.	1	1	1	1	2	1	1	1	2	
Total air flow	m ³ /h	2400	3500	3500	4200	6800	3500	3500	4200	6800	
Total power input	kW	0,10	0,14	0,14	0,17	0,28	0,14	0,14	0,17	0,28	
Max operating current FLA	A	0,98	0,98	0,98	0,98	1,96	0,98	0,98	0,98	1,96	
REFRIGERANT		R410A	R410A	R410A	R410A	R410A	R410A	R410A	R410A	R410A	
Total refrigerant charge	kg	1,50	1,75	2,90	3,00	3,00	1,75	2,90	3,00	3,00	
Gas circuits	n.	1	1	1	1	1	1	1	1	1	
POWER SUPPLY	V/Ph/Hz	230/1/50					230/1/50				
ENERGY EFFICIENCY INDEXES											
EER - Energy Efficiency Ratio	kW/kW	2,42	2,65	2,61	2,40	2,56	2,57	2,75	2,59	2,58	
COP - Coefficient of Performance	kW/kW	2,51	2,73	2,77	2,70	2,70	2,69	2,88	2,92	2,66	
IPLV - ARI Standard 550/590		2,98	3,25	3,19	2,91	3,14	3,21	3,38	3,19	3,18	
ESEER Eurovent Standard		3,37	3,68	3,61	3,28	3,55	3,63	3,81	3,61	3,60	
SOUND LEVEL - ISO 3744 (3)											
Sound pressure level (Lp)	dB(A)	50,1	55,1	55,1	55,1	58,0	55,1	55,1	55,1	58,0	
Sound power level (Lw)	dB(A)	64,0	68,9	69,5	69,5	72,8	68,9	69,5	69,5	72,8	
PUMPING GROUP											
Power input	kW	0,22	0,22	0,22	0,22	0,22	0,22	0,22	0,22	0,22	
Absorbed current	A	0,92	0,92	0,92	0,92	0,92	0,92	0,92	0,92	0,92	
DIMENSIONS											
Length	mm	900	900	900	900	900	900	900	900	900	
Width	mm	370	370	370	370	370	370	370	370	370	
Height	mm	640	640	940	940	1240	640	940	940	1240	
NET WEIGHT	kg	90	95	110	115	140	95	110	115	140	
HYDRAULIC CONNECTIONS											
PLANT WATER EXCHANGER											
Inlet / Outlet – ISO228/1-G M	Ø	3/4"	3/4"	3/4"	3/4"	1 1/4"	1 1/4"	1 1/4"	1 1/4"	1 1/4"	

1. Referred to chiller water temperature 12/7°C; 35°C ambient temperature.
2. Referred to inlet hot water temperature at 40°C; 7°C ambient temperature with 90%rH
3. Sound level 1m far in free field conditions – condenser fan side.

TECHNICAL DATA – SMART.HP – Heat pump

MODEL		T.13	T.15	T.19	T.22	T.26	T.33	T.35	T.40	T.49
SUMMER WORKING MODE (1)										
COOLING CAPACITY	kW	12,6	14,6	18,4	20,8	25,1	31,3	34,0	38,9	48,7
Compressor power input	kW	4,4	4,9	6,2	7,2	7,5	9,9	9,4	11,4	15,5
Compressor operating current	A	7,7	8,4	11,1	12,3	14,7	17,6	17,1	21,6	26,9
Plant exchanger water flow rate	m ³ /h	2,17	2,51	3,17	3,58	4,32	5,39	5,84	6,70	8,37
Plant exchanger pressure drop	kPa	34	32	37	33	38	38	38	39	39
WINTER WORKING MODE (2)										
HEATING CAPACITY	kW	14,2	16,7	20,8	23,4	28,5	35,2	37,2	43,2	57,0
Compressor power input	kW	4,7	5,1	6,6	7,2	9,0	10,6	10,2	11,9	15,5
Compressor operating current	A	8,2	8,6	11,7	12,4	17,5	18,8	18,7	22,9	27,4
COMPRESSOR		scroll	scroll	scroll	scroll	scroll	scroll	scroll	scroll	scroll
Quantity	n.	1	1	1	1	1	1	1	1	1
Max operating current FLA	A	11,8	15,0	16,0	21,0	22,0	27,0	27,0	34,0	40,0
Starting current LRA	A	64	74	95	111	118	140	140	174	225
Capacity steps	n.	1	1	1	1	1	1	1	1	1
PLANT WATER EXCHANGER	n.	1	1	1	1	1	1	1	1	1
Water volume	l	1,9	2,3	2,7	3,2	2,6	4,6	5,3	6,0	7,8
Max water flow rate	m ³ /h	3,3	3,8	4,8	5,4	6,5	8,1	8,7	10,0	12,5
AXIAL FANS	n.	2	2	2	2	3	3	2	2	2
Total air flow	m ³ /h	6800	6400	7000	7000	10500	10500	14000	16000	19000
Total power input	kW	0,28	0,26	0,28	0,28	0,43	0,43	0,84	0,96	1,12
Max operating current FLA	A	1,96	1,96	1,96	1,96	2,94	2,94	5,60	5,60	5,60
REFRIGERANT		R410A	R410A	R410A	R410A	R410A	R410A	R410A	R410A	R410A
Total refrigerant charge	kg	4,00	4,60	6,30	7,00	8,60	8,70	8,90	9,30	10,30
Gas circuits	n.	1	1	1	1	1	1	1	1	1
POWER SUPPLY	V/Ph/Hz	400/3/50+N								
ENERGY EFFICIENCY INDEXES										
EER - Energy Efficiency Ratio	kW/kW	2,70	2,83	2,84	2,78	3,17	3,03	3,32	3,15	2,93
COP - Coefficient of Performance	kW/kW	2,87	3,12	3,03	3,12	3,03	3,19	3,37	3,36	3,43
IPLV - ARI Standard 550/590		3,20	3,48	3,49	3,42	3,90	3,73	4,07	3,85	3,60
ESEER Eurovent Standard		3,75	3,94	3,94	3,87	4,40	4,21	4,60	4,35	4,07
SOUND LEVEL - ISO 3744 (3)										
Sound pressure level (Lp)	dB(A)	58,0	58,2	63,0	63,1	62,1	62,1	64,3	65,1	69,1
Sound power level (Lw)	dB(A)	72,8	73,3	78,5	78,6	77,5	77,5	80,4	81,3	85,5
PUMPING GROUP										
Power input	kW	0,22	0,22	0,55	0,55	0,55	0,55	0,55	0,55	0,75
Absorbed current	A	0,92	0,92	3,80	3,80	3,80	3,80	3,80	3,80	4,80
DIMENSIONS										
Length	mm	900	900	1450	1450	1450	1450	1508	1508	1758
Width	mm	370	420	550	550	550	550	613	613	613
Height	mm	1240	1390	1200	1200	1700	1700	1700	1700	1700
NET WEIGHT	kg	160	170	265	270	340	345	355	360	440
HYDRAULIC CONNECTIONS										
PLANT WATER EXCHANGER										
Inlet / Outlet – ISO228/1-G M	Ø	1 1/4"	1 1/4"	1 1/4"	1 1/4"	1 1/4"	1 1/4"	1 1/2"	1 1/2"	1 1/2"

1. Referred to chiller water temperature 12/7°C; 35°C ambient temperature.
2. Referred to inlet hot water temperature at 40°C; 7°C ambient temperature with 90%rH
3. Sound level 1m far in free field conditions – condenser fan side.

ACOUSTIC DATA

MODEL		M.5	M.6	M.7	M.9	M.11	T.6	T.7	T.9	T.11
Sound power level (1)	dB(A)	64,0	68,9	69,5	69,5	72,8	68,9	69,5	69,5	72,8
Sound pressure level at 1m (2)	dB(A)	50,1	55,1	55,1	55,1	58,0	55,1	55,1	55,1	58,0
Sound pressure level at 5m (3)	dB(A)	38,5	43,5	43,8	43,9	47,1	43,5	43,8	43,9	47,1
Sound pressure level at 10m (3)	dB(A)	32,8	37,8	38,2	38,3	41,5	37,8	38,2	38,3	41,5

MODEL		T.13	T.15	T.19	T.22	T.26	T.33	T.35	T.40	T.49
Sound power level (1)	dB(A)	72,8	73,3	78,5	78,6	77,5	77,5	80,4	81,3	85,5
Sound pressure level at 1m (2)	dB(A)	58,0	58,2	63,0	63,1	62,1	62,1	64,3	65,1	69,1
Sound pressure level at 5m (3)	dB(A)	47,1	47,4	52,5	52,6	51,6	51,6	54,2	55,1	59,3
Sound pressure level at 10m (3)	dB(A)	41,5	41,9	47,1	47,2	46,1	46,1	48,9	49,8	54,0

1. Sound power level (L_w) according to ISO3744.
2. Sound pressure level (L_p) in free field according to ISO3744
3. Sound pressure level (L_p) in free field

IMPORTANT

For further information about units acoustic data, please refer to “The Noise” bulletin of RC GROUP technical literature.

ELECTRIC DATA**MAXIMUM ELECTRIC ABSORPTION CALCULATION**

This chapter is showing the maximum electrical absorption calculation of unit (A), corresponding to extreme working conditions.

The involved components are the following:

- Compressors electric motor
- Condensers fans electric motors
- Water pump electric motor

The electrical data of the various components are indicated in the relative technical data sheets.

EXAMPLE:

Calculation for SMART.M.7

MAXIMUM ELECTRIC ABSORPTION

- Compressor	A	19,00	+
- Condenser fans	A	0,98	+
- Water pump	A	0,92	=
Maximum electric absorption	A	20,90	

MINIMUM PLANT WATER CONTENT

Model		5	6	7	9	11	13	15	19	22	26	33	35	40	49
SMART.HP	I	19	24	27,3	31,5	40	46	57	74	85	103	124	131	150	194
SMART	I	14	18	20,3	24	30,5	36	43,5	55	65	78	94	100	114	140

MICROPROCESSOR CONTROL SYSTEM

From model M5 up to model T33 included: HSW7 microprocessor control

The microprocessor control system is equipped with 2 keys and display on which all information in easily identifiable symbols are displayed.



From model T35 up to model T49: ST500 microprocessor control

The microprocessor control system is equipped with 4 keys and display on which all information in easily identifiable symbols are displayed.



REMOTE COMMAND / ALARMS

Unit terminals	Command / Alarms
10 – 11	Unit alarm lamp
12 – 13	Compressor On lamp
6 – 7	On / Off switch and timer
14 – 15	Water flow switch
8 – 9	Summer / Winter selector (only heat pump)
18 – 19 – 20	Remote keyboard

PUMPING GROUP

Factory assembled pumping group.
 The system don't modify the water chiller dimensions.
 The system includes:

- water pump.
- expansion tank.
- water safety valve.
- water pressure gauge.
- Air vent

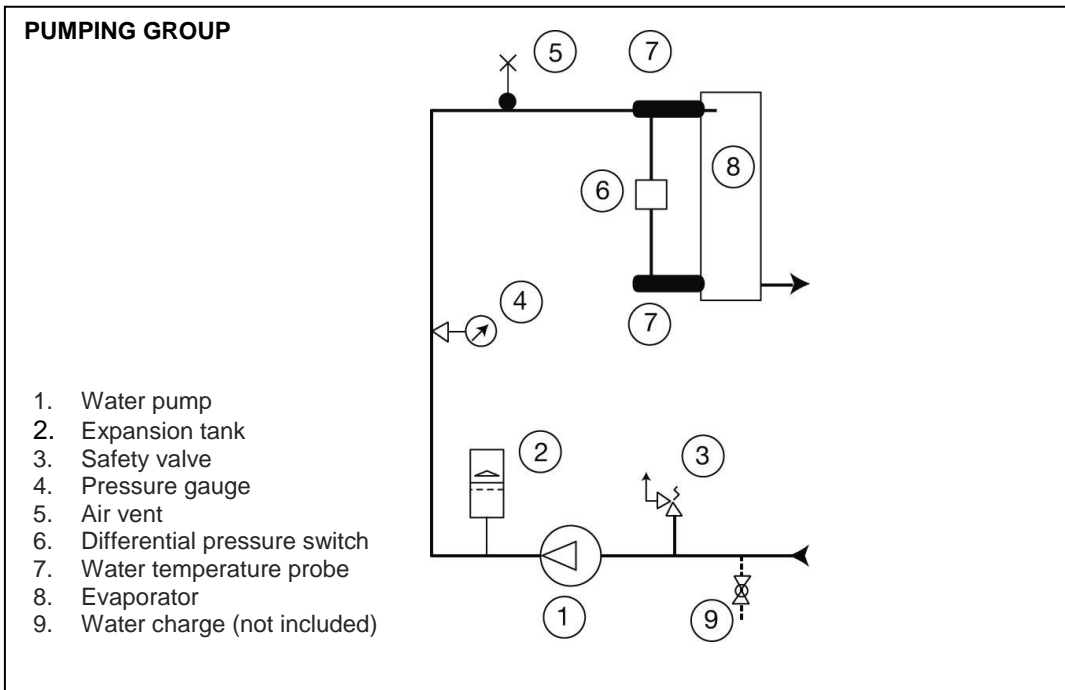

TECHNICAL DATA

SIZE		M5 ÷ T15	T19 – T22	T26 – T33	T35 – T40	T49
WATER FLOW RATE						
Minimum water flow rate	m ³ /h	0,5	1,5	1,5	1,5	1,5
Maximum water flow rate	m ³ /h	6,7	5,0	8,5	8,6	15,0
DISCHARGE HEAD						
At minimum water flow rate	kPa	55	200	205	220	230
At maximum water flow rate	kPa	8	70	50	50	50
WATER PUMP						
Motor speed	n.	3	1	1	1	1
Power input	kW	0,22	0,55	0,55	0,55	0,75
Operating current	A	0,92	3,80	3,80	3,80	4,80

WATER PUMPS PERFORMANCES

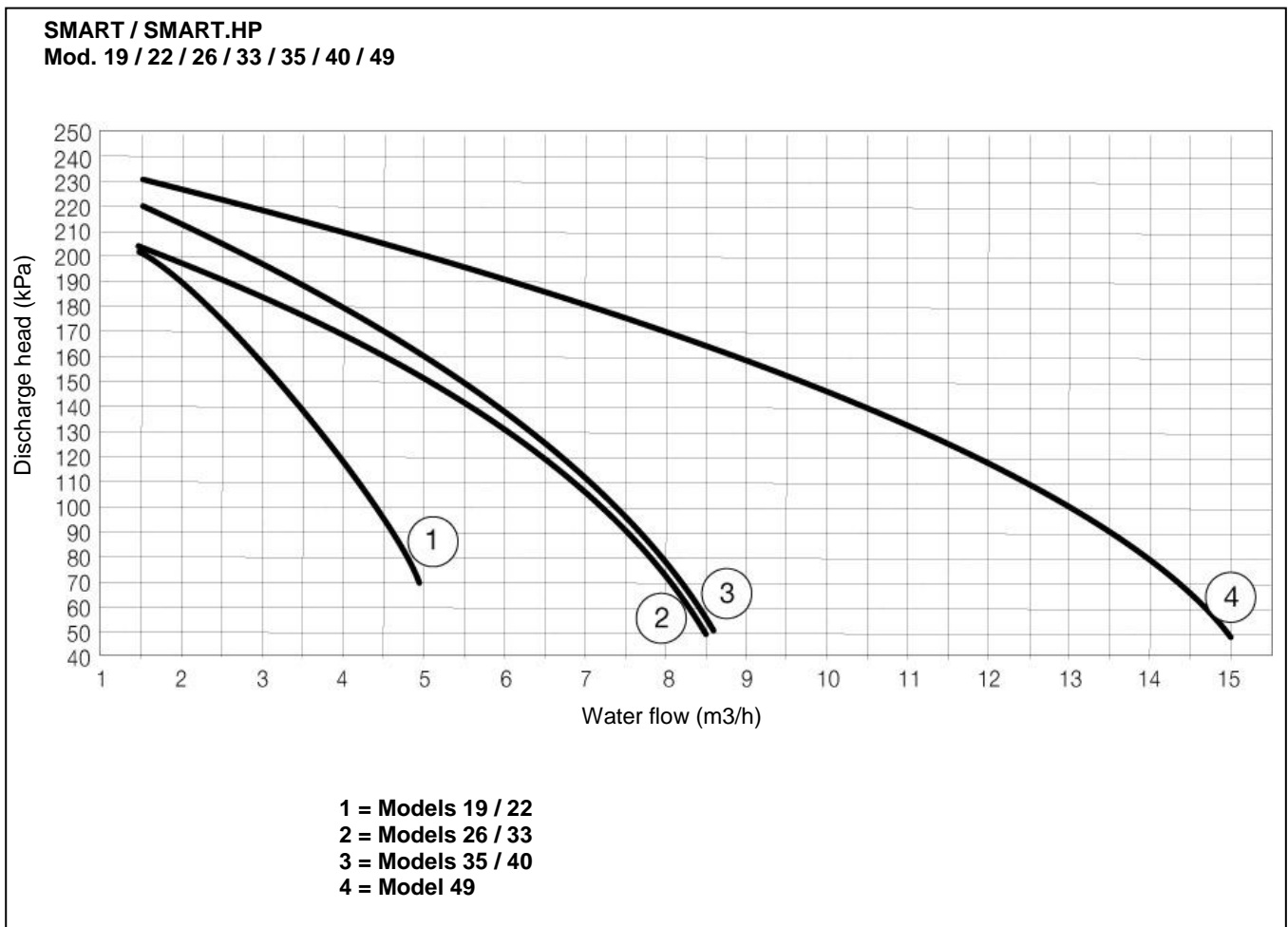
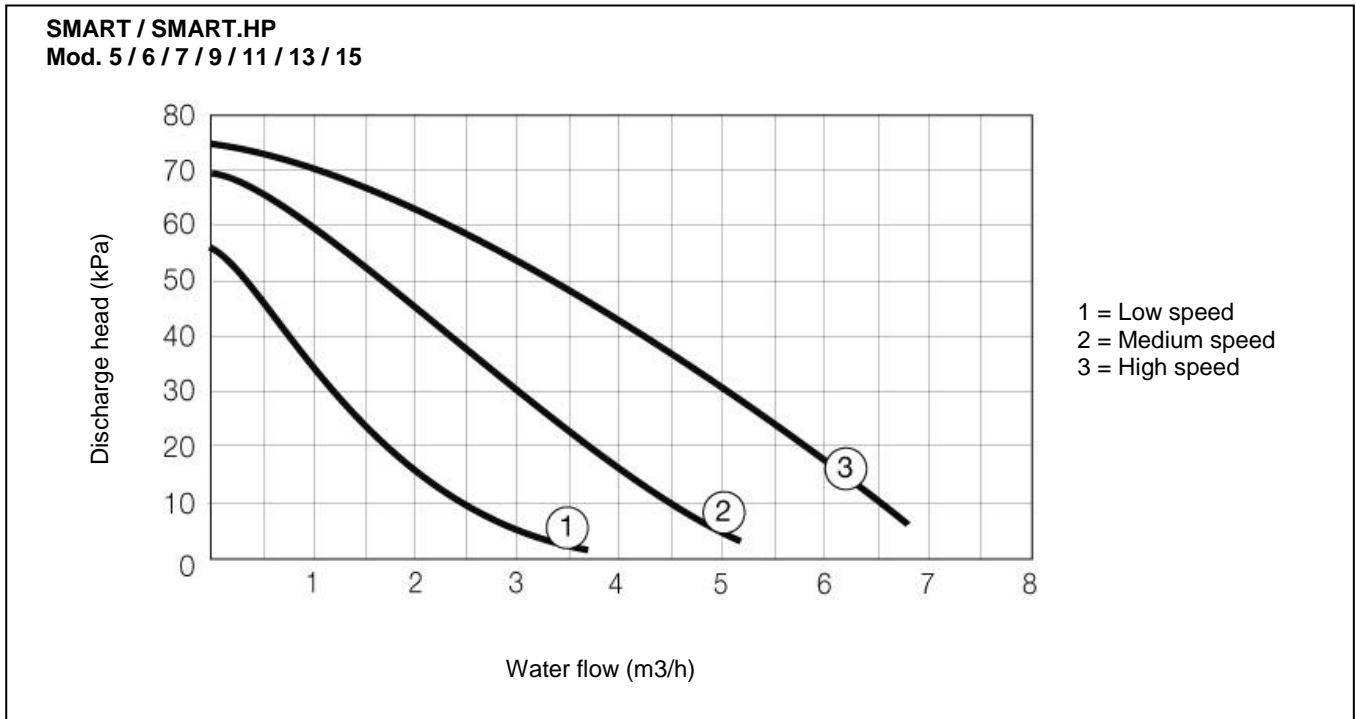

OPTIONAL ACCESSORIES – STORAGE TANK KIT

Optional available for models 5 / 6 / 7 / 9 / 11 / 13 / 15 / 19 / 22 / 26 / 33.

The kit is used when the plant does not allow the minimum quantity of water as previously described.

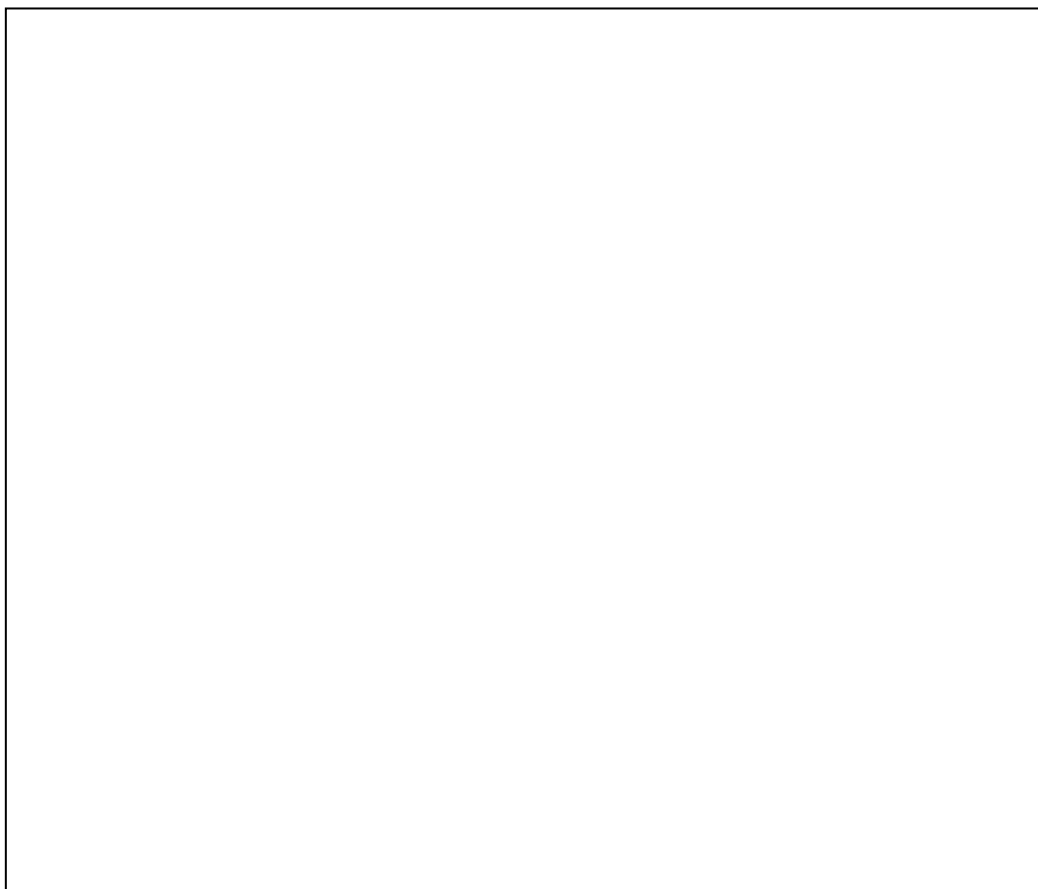

OPTIONAL ACCESSORIES – TANK CONNECTION PIPE KIT

Optional available for models 5 / 6 / 7 / 9 / 11 / 13 / 15 / 19 / 22 / 26 / 33.
The kit allow connection between storage tank and the chiller

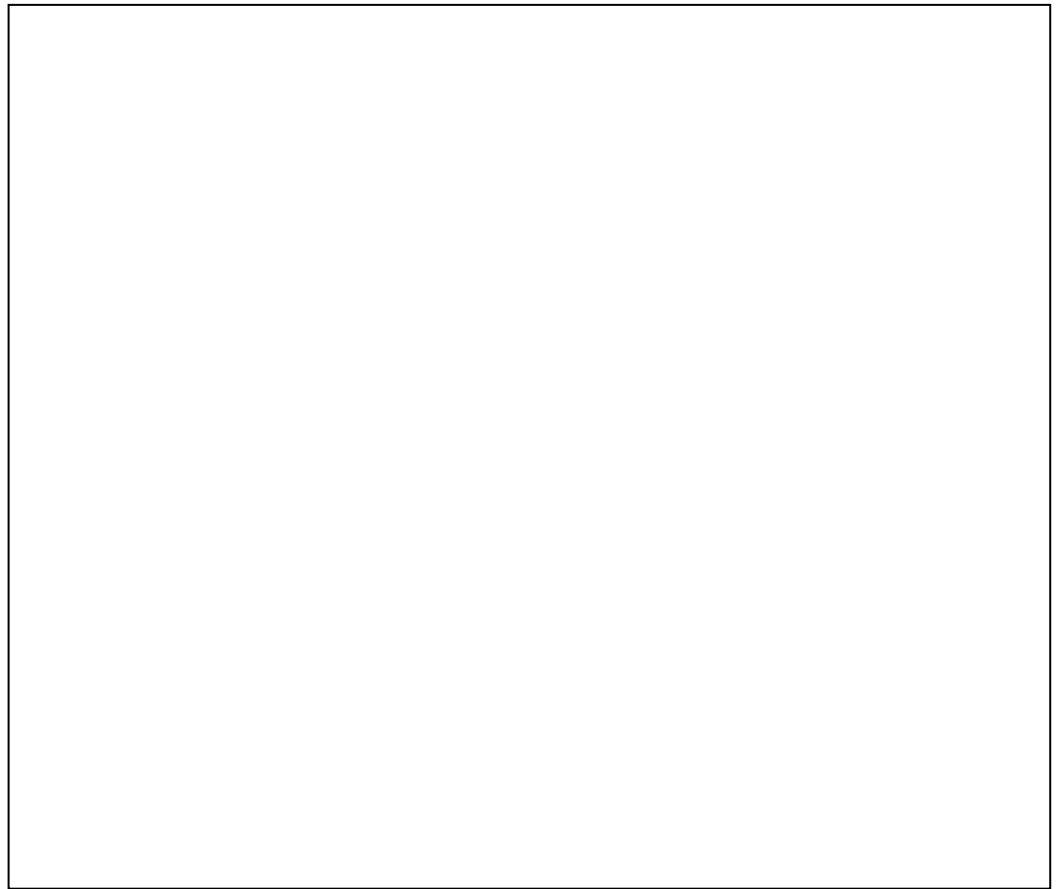

OPTIONAL ACCESSORIES – METALLIC MESH FILTER KIT

Optional available for every unit.

The optional allows water filtration and the collection of any impurities in the hydraulic circuit.

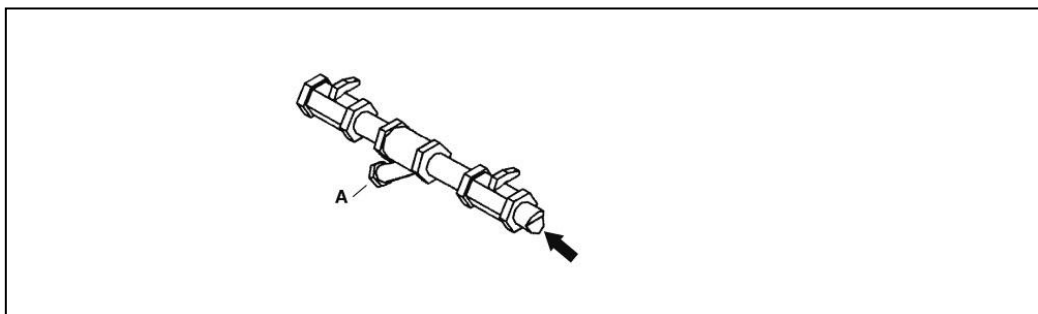

WATER FLOW / PRESSURE DROPS DIAGRAM FOR A CLEAN FILTER

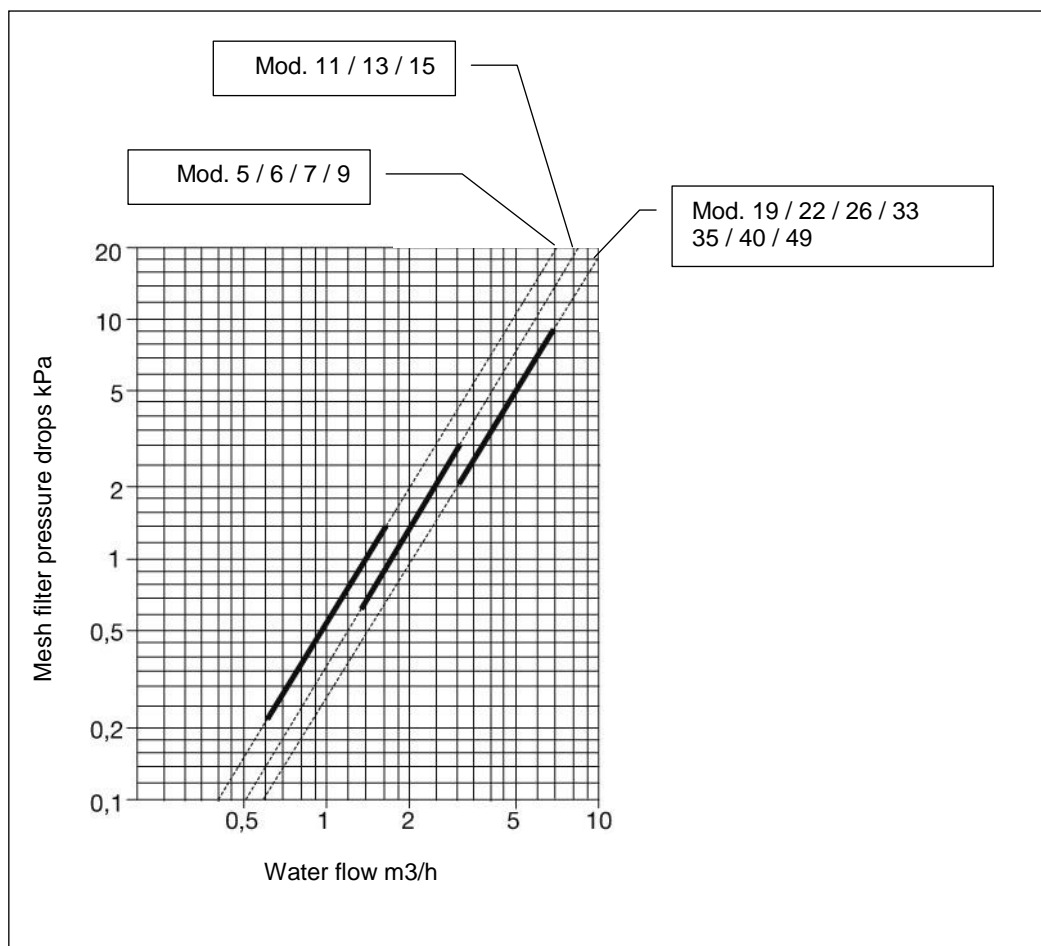

OPTIONAL ACCESSORIES – ADDITIONAL WATER PUMP

Optional available for units series SMART / SMART.HP model 11 / 13 / 15
 The optional allows to increase the discharge head and it is supplied with electric cable for connection to the unit electric box.
 The pump is installed inside the chiller.

ADDITIONAL WATER PUMP PERFORMANCE

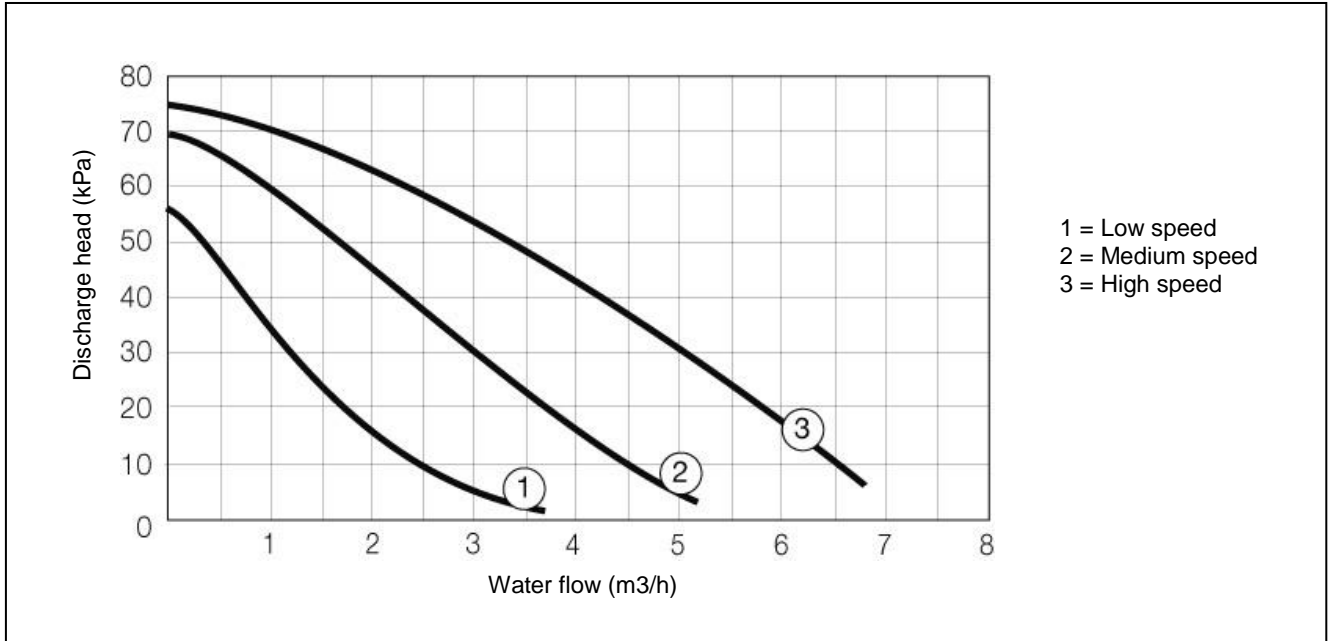

TECHNICAL DATA

SIZE		M5 ÷ T15
WATER FLOW RATE		
Minimum water flow rate	m ³ /h	0,5
Maximum water flow rate	m ³ /h	6,7
DISCHARGE HEAD		
At minimum water flow rate	kPa	55
At maximum water flow rate	kPa	8
WATER PUMP		
Motor speed	n.	3
Power input	kW	0,22
Operating current	A	0,92

OPTIONAL ACCESSORIES – REMOTE CONTROL PANEL KIT

HSW7 microprocessor control system

Optional available for models 5 / 6 / 7 / 9 / 11 / 13 / 15 / 19 / 21 / 26 / 33.

The optional allows the remote unit management and displaying of the working parameter and sets.

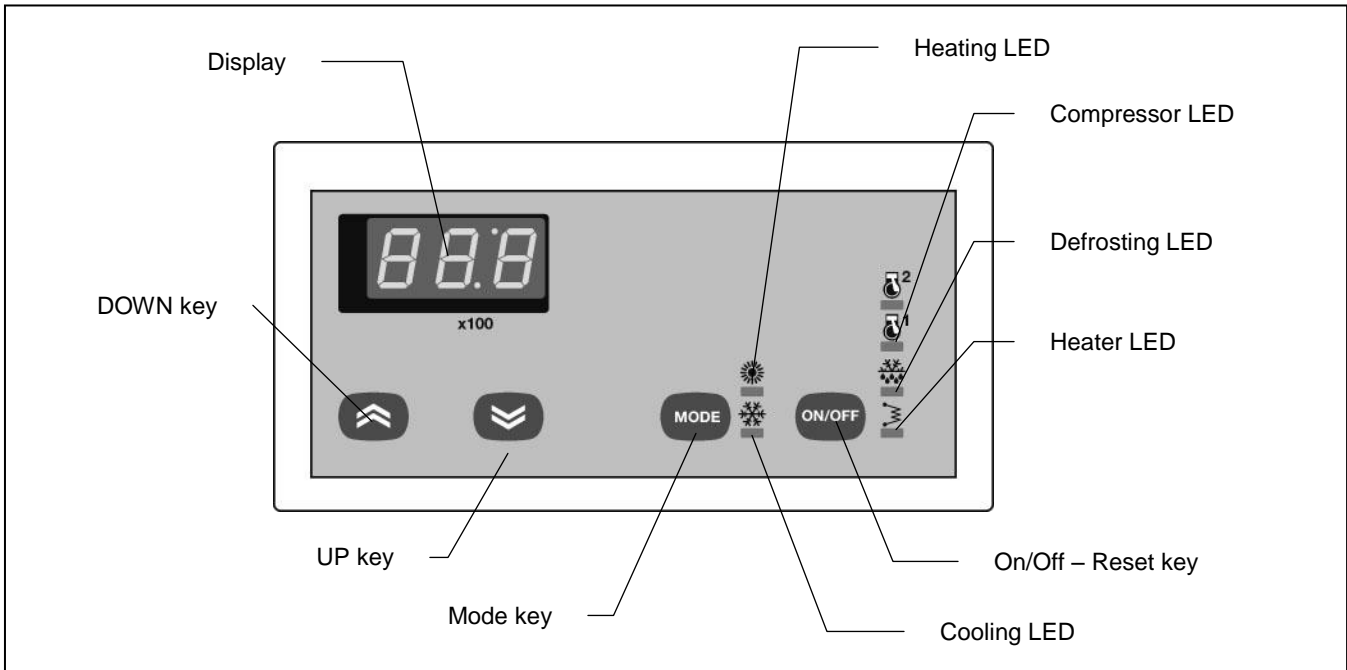

ST500 microprocessor control system

Optional available for models 35 / 40 / 49.

The optional allows the remote unit management and displaying of the working parameter and sets.

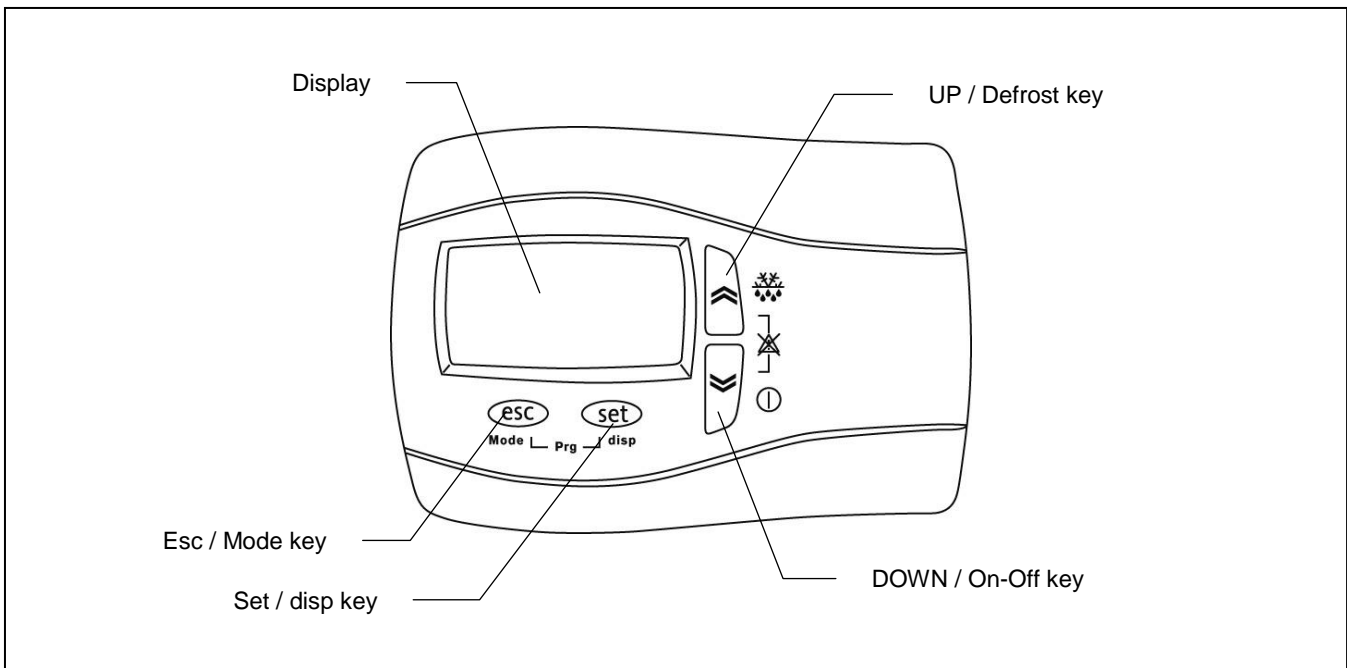

ST500” RC-COM MBUS/JBUS SERIAL INTERFACE KIT

RC-Com Mbus/Jus is an interface module that connects the TTL communication line and the RS-485 serial line.

USER INTERFACE

- The red LED (POWER) indicates when the device is powered (permanently on).
- The green LED (RX-TX) indicates when the device is communicating in RS 485 (flashes on and off).

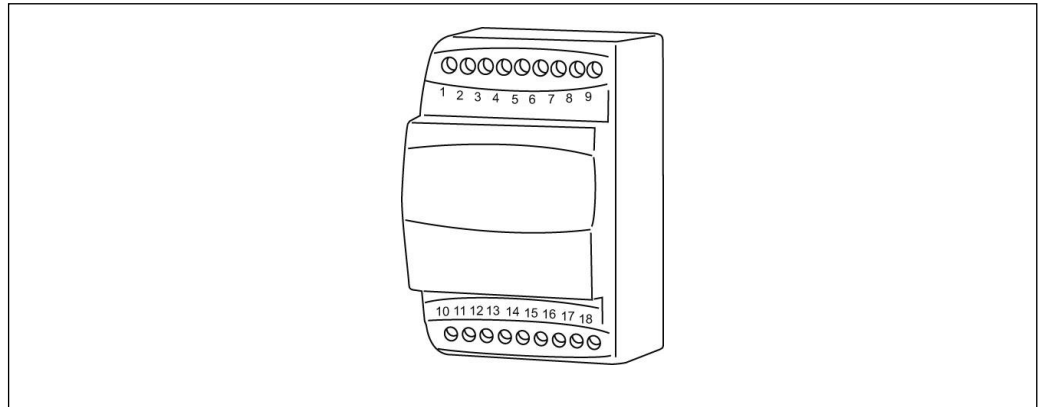

TECHNICAL DATA

Frontal panel protection: IP40.

Housing: plastic 3 Din modules.

Mounting: on Din rail.

Connections: screw terminal block for wires $\leq 2.5 \text{ mm}^2$ (one wire per terminal for power supply).

Serial connections: double RS-485 serial port / TTL for connection with instruments;

Baud rate: 2400...9600 Baud.

Insulation Class: 2.

Power supply: 230Va/115Va.

Consumption: 1,5 VA.

Instruments are supplied with a special cable for the TTL serial connection.

TERMINALS

1 - 3 Serial Port RS 485

4 - 6 Serial Port RS 485*

8 - 9 230 Va Supply **

A TTL port for connection to the instrument (see picture)

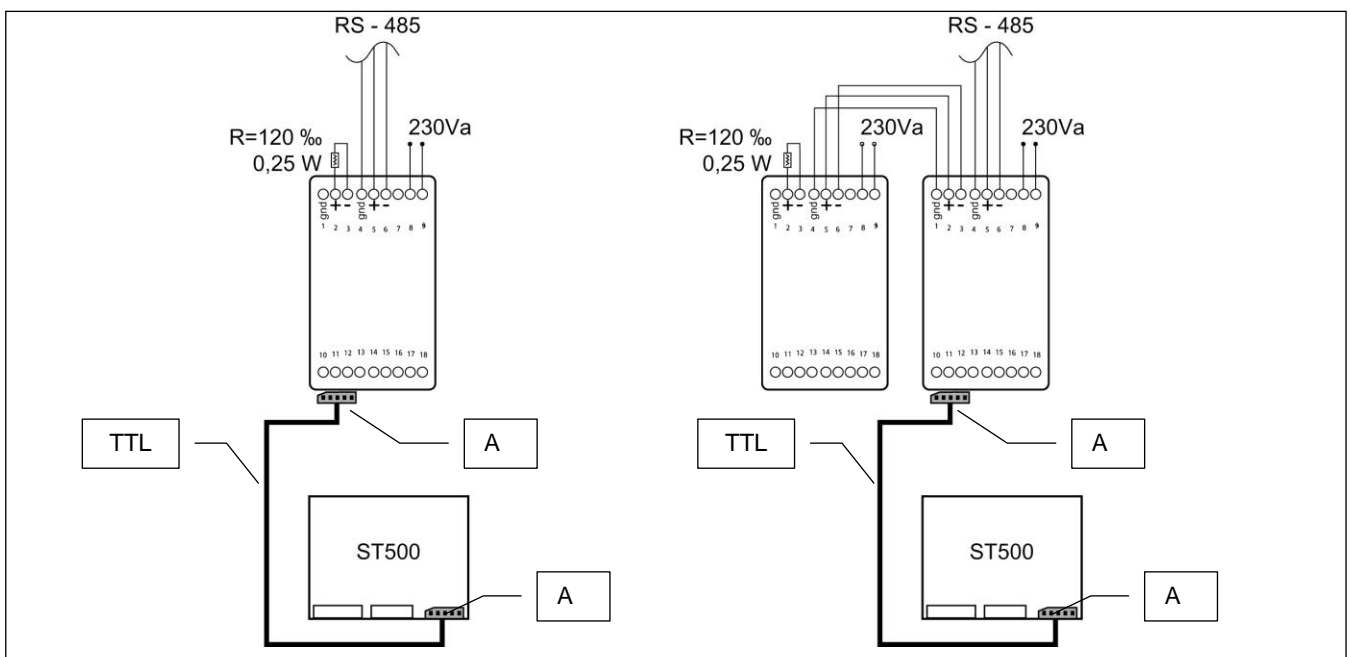

UNIT DRAWINGS

Dimensions in mm

SMART -SMART.HP 5 / 6

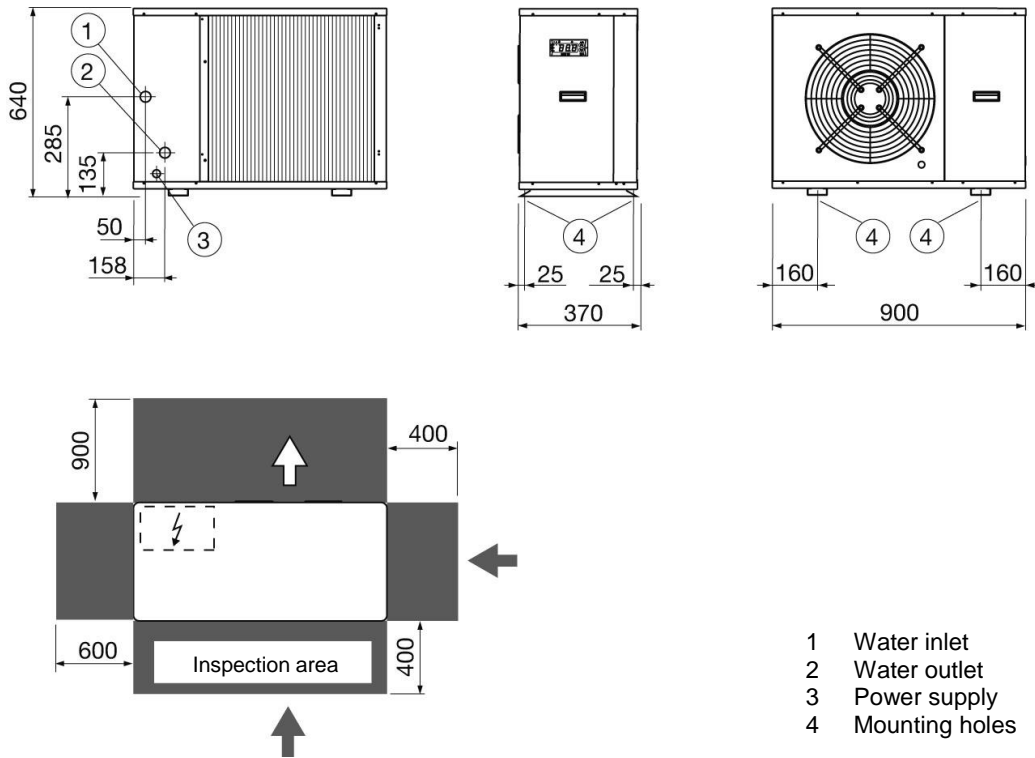

SMART – SMART.HP 7 / 9

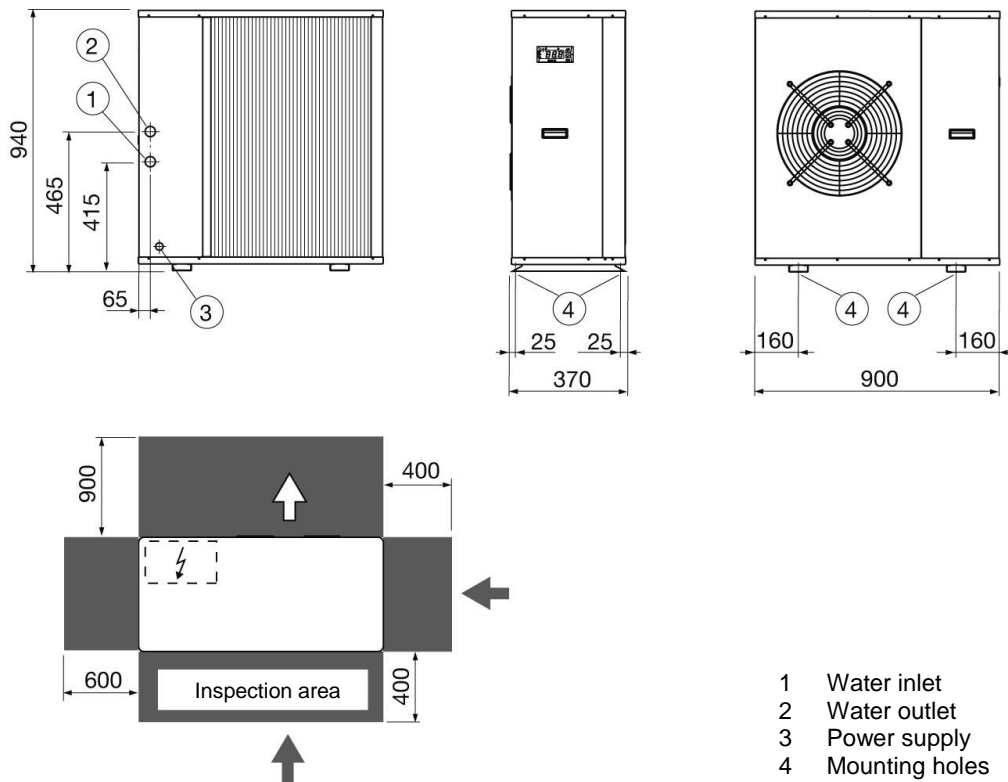

UNIT DRAWINGS
Dimensions in mm

SMART – SMART-HP 11 / 13

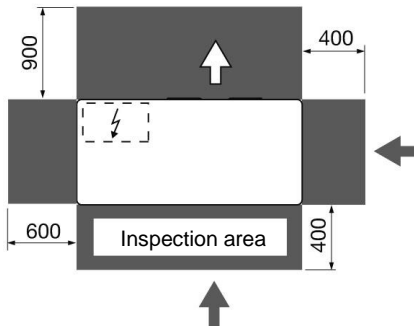
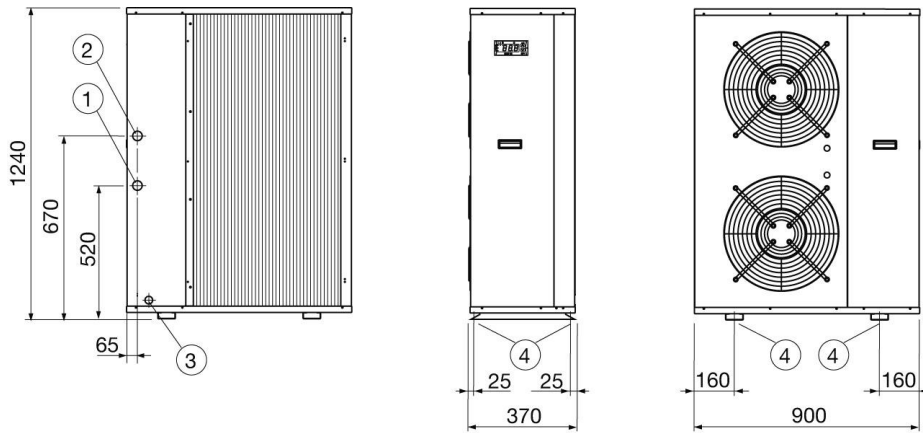

- 1 Water inlet
- 2 Water outlet
- 3 Power supply
- 4 Mounting holes

SMART – SMART-HP 15

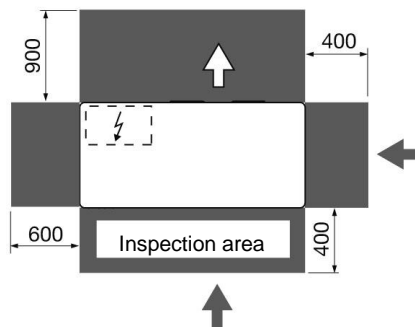
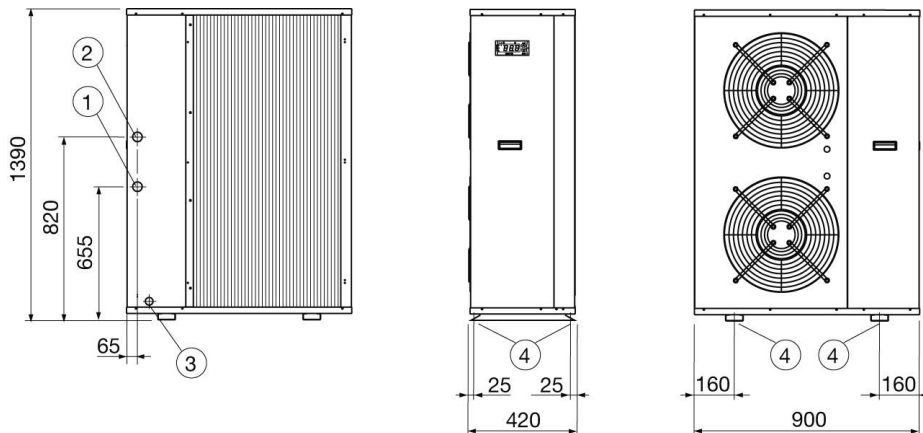

- 1 Water inlet
- 2 Water outlet
- 3 Power supply
- 4 Mounting holes

UNIT DRAWINGS
Dimensions in mm

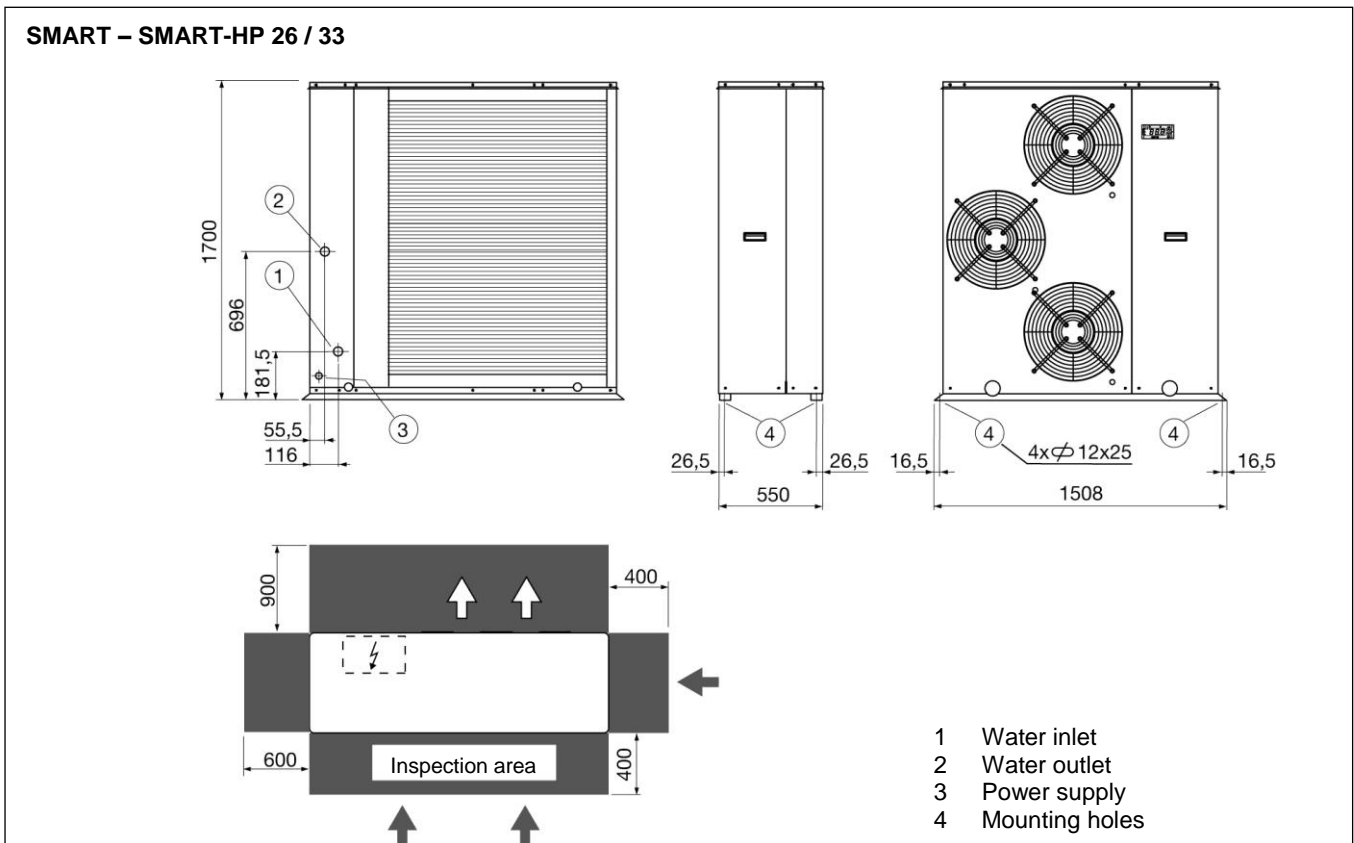
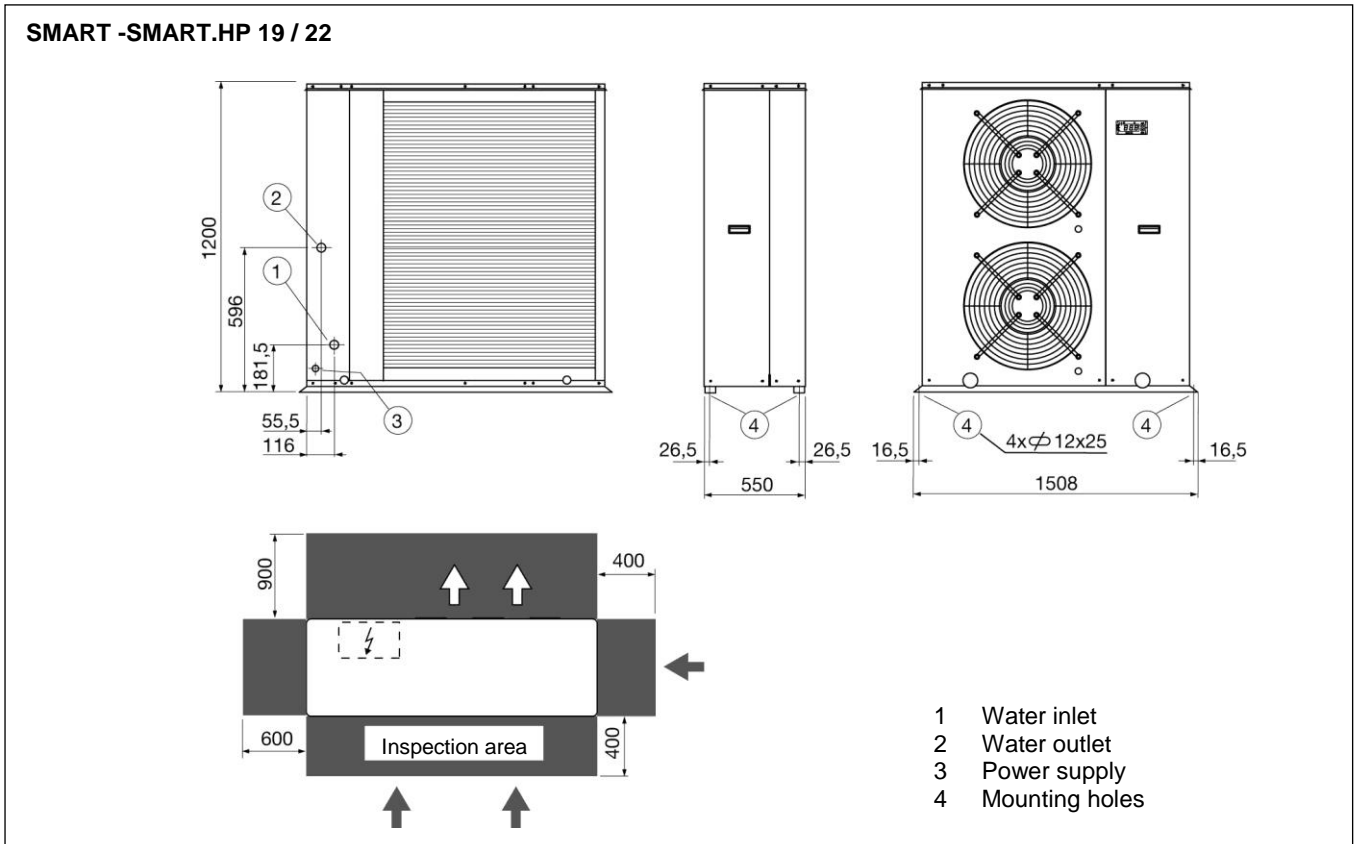

UNIT DRAWINGS
Dimensions in mm

SMART – SMART-HP 35 / 40

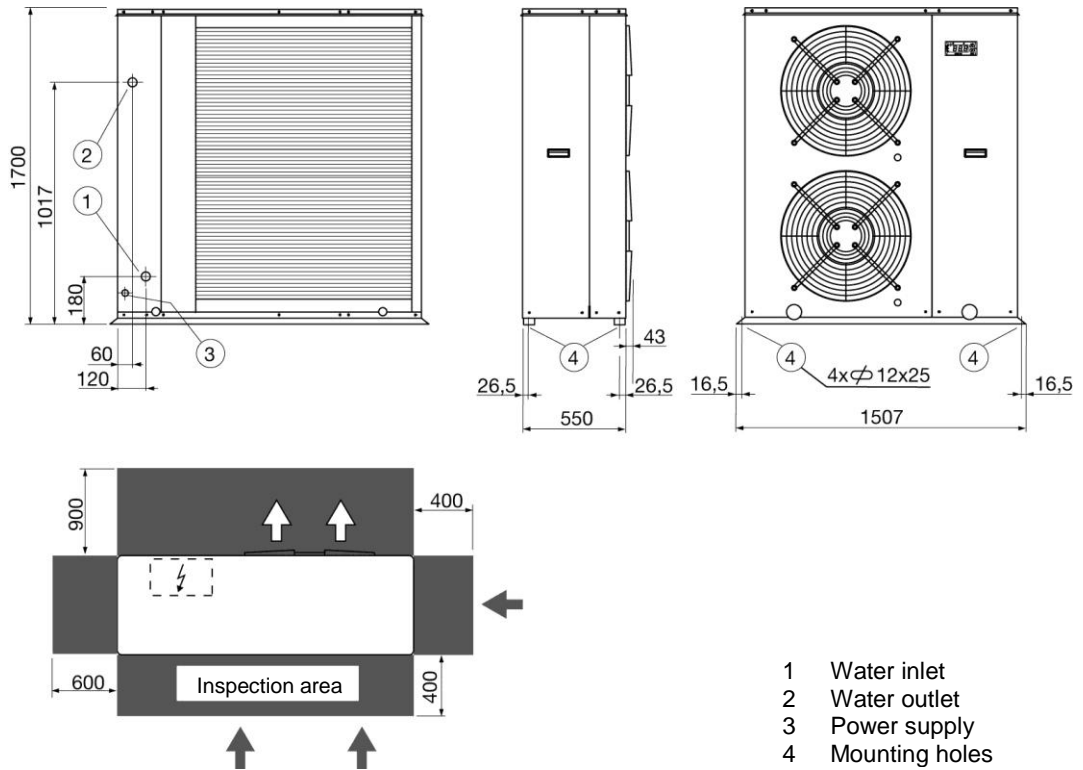

SMART – SMART-HP 49

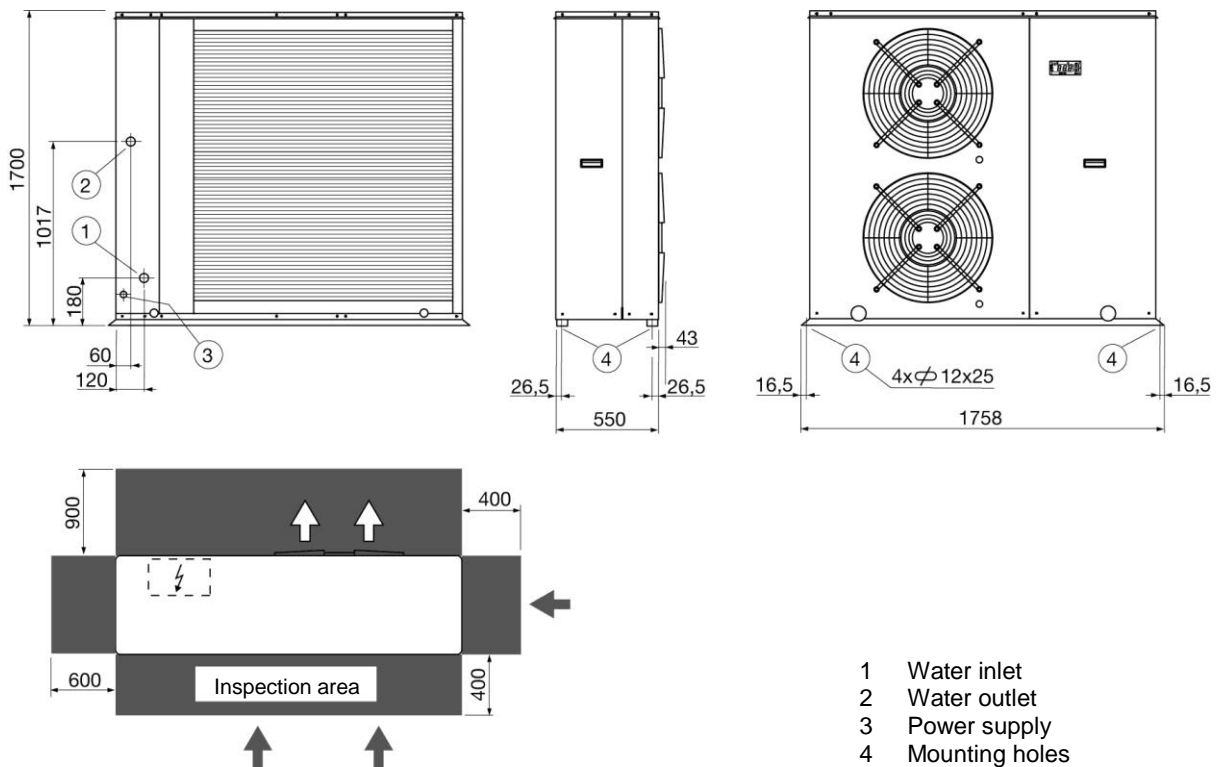

Technical data and dimensions are not binding.
RC GROUP S.p.A. reserves the right of effecting opportune modifications without previous notice.



RC GROUP S.p.A. • Via Roma, 5 • 27010 Valle Salimbene (PV), Italy
www.rcgroup.it • Tel. +39 (0) 382 433 811 • Fax +39 (0) 382 587 148

T_SMT_0609_GB