

**OPERATING INSTRUCTIONS • ISTRUZIONI D'USO
NOTICE D'UTILISATION • BEDIENUNGSANLEITUNG
INSTRUCCIONES DE USO**

**K2FAFIA0R5I--
K2FAFIB0R5I--**

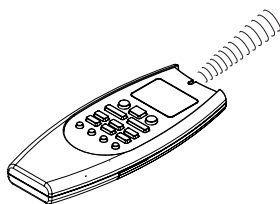
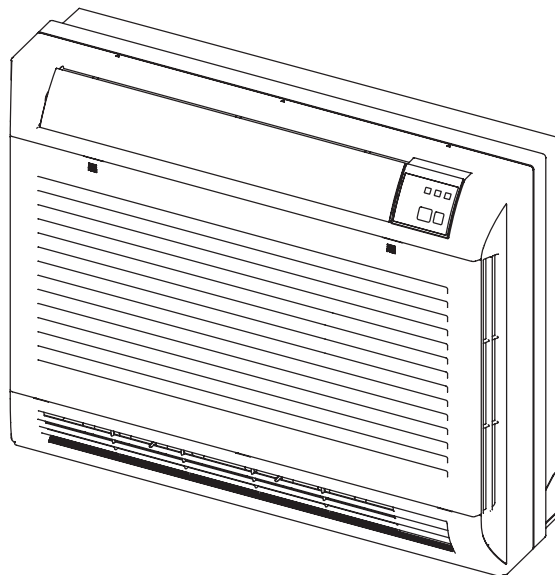

**Split air conditioner system • Condizionatore d'aria split system
Climatiseurs split • Split-klimagerät
Acondicionador de aire de consola partida sistema split**

CONTENTS

NAME OF PARTS AND OPERATION SELECTOR SWITCH	3
INSTALLATION LOCATION	4
ELECTRICAL REQUIREMENTS	4
SAFETY INSTRUCTIONS	4
USING THE REMOTE CONTROL UNIT	4
REMOTE CONTROL UNIT	5
HOW TO SET THE PRESENT TIME	6
COOLING	6
HEATING	6
AUTOMATIC OPERATION	6
DEHUMIDIFYING (DRY)	7
FAN ONLY	7
ADJUSTING THE FAN SPEED	7
FILTER TiO ₂	7
NIGHT MODE/ENERGY SAVING	7
HIGH POWER MODE	8
SETTING THE TIMER	8
SETTING THE 1 HOUR TIMER	8
SETTING THE HOLIDAY TIMER	8
ADJUSTING THE AIR FLOW DIRECTION	9
OPERATION WITHOUT THE REMOTE CONTROL UNIT	10
CARE AND CLEANING	10
TIPS FOR ENERGY SAVING	11
TROUBLESHOOTING	11

PRODUCT INFORMATION

If you have problems or questions concerning your Air Conditioner, you will need the following information. Model and serial numbers are on the nameplate on the bottom of the cabinet.

Model No. _____
 Serial No. _____
 Date of purchase _____
 Dealer's address _____
 Phone number _____

ALERT SYMBOLS

The following symbols used in this manual, alert you to potentially dangerous conditions to users, service personnel or the appliance:



WARNING

This symbol refers to a hazard or unsafe practice which can result in severe personal injury or death.



CAUTION

This symbol refers to a hazard or unsafe practice which can result in personal injury or product or property damage.

NOTE

This air conditioner is equipped with cooling, drying, heating and fan only functions. Details on these functions are provided below; refer on these descriptions when using the air conditioner.

DECLARATION OF CONFORMITY

This product is marked **CE** as it satisfies Directives:

- Low voltage no. 2006/95/CE. (Standard: EN60335-2-40:2003 (incl. Corr.:2006) + A11:2004 + A12:2005 + A13:2012 + A1:2006 + A2:2009 con EN 60335-1:2002 + A11:2004 + A1:2004 + A12:2006 + A2:2006 + A13:2008 + A14:2010 + A15:2011).
- Electromagnetic compatibility no. 2004/108/CE, 92/31 EEC and 93/68 EEC. (Standard: EN55014-1 (2006) + A1(2009) + A2(2011), EN 55014-2 (1997) + A1(2001) + A2 (2008), EN 61000-3-2 (2006) + A1(2009) + A2(2009), EN 61000-3-3 (2008)
- RoHS2 no.2011/65/EU.
- Regulation (EU) no. 206/2012, of 6 march 2012, concerning the specifications for ecodesign requirements of air conditioners and fans.
- Regulation (EU) no. 626/2011, of 4 may 2011, concerning the labeling indicating the energy consumption of air conditioners.

This declaration will become void in case of misuse and/or non observance though partial of manufacturer's installation and/or operating instructions.

NAME OF PARTS AND OPERATION SELECTOR SWITCH

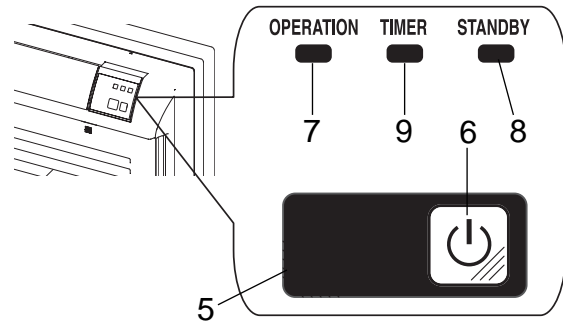
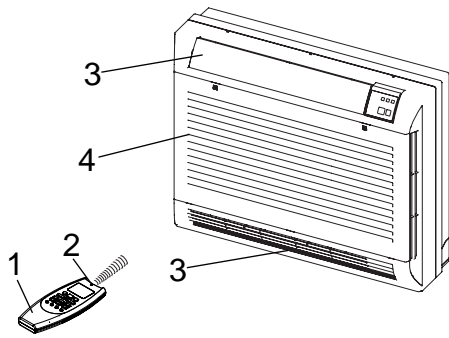

1. **Remote control unit.**
2. **Remote control sensor:** Detects the room temperature around the remote control unit, the air conditioner is controlled accordingly.
3. **Air outlet:** Conditioned air is blown out of the air conditioner through the air outlet.
4. **Air intake:** Air from the room is drawn into this section and passes through air filter which removes dust.
5. **Remote control receiver:** This section picks up infrared signals from the remote control unit (Transmitter).
6. **Operation selector (without remote control):** Push the button to walk through the operation modes (OFF, COOL and HEAT)



WARNING

The OFF position does not disconnect the power. Use the main power switch to turn off power completely.

7. **OPERATION lamp:** This lamp lights up during operation. It blinks once to announce that the remote control signal has been received and stored.
8. **STANDBY lamp:** This lamp lights up when the air conditioner is connected to the power and ready to receive the remote control command.
9. **TIMER lamp:** This lamp lights up when the system is being controlled by the timer.

NOTES

- It is possible to set the air conditioner in order to let the OPERATION, TIMER and STANDBY lamps always OFF, even during operation. Be sure that CLEAN/FILTER TiO₂ mode is OFF. Press contemporary the IFEEL and FAN buttons on the remote control unit for more than 5 seconds. Repeat the same procedure to set again the normal operation conditions.
- In case of troubleshooting the air conditioner diagnostic system activates the lamps accordingly, even if they are set to OFF. See paragraph TROUBLESHOOTING for further details.

MULTI SPLIT SYSTEM only

The blinking of TIMER and STANDBY lamps and OPERATION lamp ON, indicates that:

1. Indoor unit has not been addressed.
2. Heating mode has been selected, when the system was in cooling mode, or vice versa. Select the correct mode, compatible with the system.

INSTALLATION LOCATION

- We recommend this air conditioner to be installed properly by qualified installation technicians in accordance with the installation instructions provided with the unit.



WARNING

- Do not install this air conditioner where there are fumes or flammable gases, or in an extremely humid space such as a green house.
- Do not install the air conditioner where excessively high heat-generating objects are placed.
- Do not install the air conditioner where the atmosphere is extremely damp or humid (e.g. greenhouse or laundry) it could be wetted by drops of water (i.e. in laundries).
- To protect the air conditioner from heavy corrosion, avoid installing the outdoor unit where salty sea water can splash directly onto it or in sulphurous air near a spa.

ELECTRICAL REQUIREMENTS

- Before installation, check that the voltage of the electric supply in your home or office is the same as the voltage shown on the nameplate.
- All wiring must conform to the local electrical codes. Consult your dealer or a qualified electrician for details.
- Each unit must be properly grounded with a ground (or earth) wire or through the supply wiring.
- Wiring must be done by a qualified electrician.

SAFETY INSTRUCTIONS

- Read this booklet carefully before using this air conditioner. If you still have any difficulties or problems, consult your dealer for help.
- This air conditioner is designed to give you comfortable room conditions. Use this only for its intended purpose as described in this Instruction Manual.



WARNING

- Never use or store gasoline or other flammable vapor or liquid near the air conditioner. It is very dangerous.
- Never install electrical equipment, which is not protected with IPX1 protection (protection against vertical water drop), under the unit.
- The manufacturer assumes no responsibilities if the safety regulations or local codes are not observed.



CAUTION

- Never use the power main switch to start or stop the air conditioner: always use the ON/OFF button on the remote control unit or the selector switch on the unit.
- Do not let children play with the air conditioner.
- Do not cool the room too much if babies or invalids are present.
- This air conditioner is not intended for use by persons (including children) with reduced physical, sensory or mental capabilities, or lack of experience and knowledge, unless they have been given supervision or instruction concerning use of the air conditioner by a person responsible for their safety.

USING THE REMOTE CONTROL UNIT

HOW TO INSTALL BATTERIES

- Remove the lid in the rear part of the remote control unit and check the settings of the four microswitches as shown below:

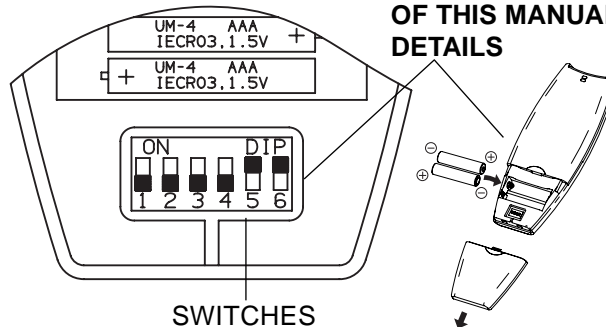

- Insert two AAA alkaline batteries of 1,5 V-DC making sure that point in the direction marked in the battery compartment. The displayed time flashes. Press the SEL TYPE button. Remote controller is now ready for operation.
- The batteries last average more than six months, anyway it depends on how much you use the remote control unit. Remove the batteries if you do not use the remote control unit for more than one month. Replace the batteries when the remote control unit lamp fails to light, or when the air conditioner does not receive the remote control unit signals.
- The batteries of the remote control contain polluted substances. Exhausted batteries must be disposed according to the laws in force.

NOTE

IF YOU INSTALL MORE THAN ONE INDOOR UNIT IN THE SAME ROOM:

It is possible to utilise only one remote control for all the units.

On the contrary, if you want to address each remote control to its unit, follow the procedure "Remote control unit/indoor unit address" (see Installation Instructions).

TEMPERATURE SENSOR SELECTOR

- Under normal conditions the room temperature is detected and checked by the temperature sensor placed in the remote controller (I FEEL icon displayed). This function is designed to provide a comfortable room temperature by transmitting the temperature control command from the location next to you. When using this function, the remote control should always be pointed at the air conditioner, therefore it should be placed in a position in which it is visible by the indoor unit (for example, do not put it in a drawer).
- It is possible to disable the remote controller room sensor pressing the I FEEL button. In this case the I FEEL icon on the remote controller display lights off and only the sensor placed in the air conditioner becomes active.

NOTE

The remote control unit transmits signals to the indoor unit each time you press a key and at any temperature change detected by the IFEEL sensor. In case of troubles (low batteries, remote control placed in a position not visible by the indoor unit,...) room temperature control is automatically switched to the sensor of the indoor unit. In this case, the temperature around the remote control unit may differ from the temperature detected in the air conditioner position.

OPERATION WITH THE REMOTE CONTROL UNIT

When using the remote control unit, always point the unit transmitter head directly at the air conditioner receiver.

HOW TO TURN ON THE AIR CONDITIONER

Press the ON/OFF button to turn the air conditioner on. The operation lamp will light up, indicating the unit is in operation.

REMOTE CONTROL UNIT

DISPLAY

Information is displayed when the remote controller is switched on. If switched off, only the operating mode, the room temperature and the clock are shown

I FEEL mode is active (remote controller sensor active)

Operation mode

- Automatic
- Cooling
- Heating
- Dehumidification
- Fan
- Night mode
- Oscillation Flap
- HIGH POWER mode

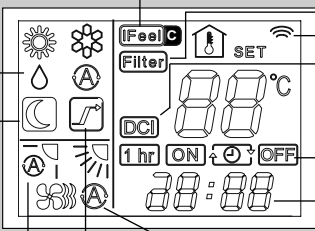

- Filter TiO₂ is ON
- Displayed when transmitting data
- Inverter model
- Timer modes
- Clock

Fan speed

- Automatic
- High speed
- Medium speed
- Low speed

Room temperature

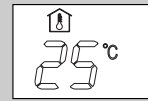

Set point temperature

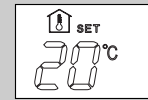

MODE SELECTOR BUTTON

Press this button to modify the air conditioner mode.

(cooling)

The air conditioner makes the room cooler.

(dry)

The air conditioner reduces the humidity in the room.

(automatic)

When this setting is selected, the air conditioner calculates the difference between the thermostat setting and the room temperature and automatically switches to the "cool" or "heat" mode.

(fan)

The air conditioner works only as a circulation fan.

SENSOR

A temperature sensor inside the remote control unit detects the room temperature.

TRANSMITTER

When you press the buttons of the remote control unit, the mark appears on the display to transmit the setting changes to the receiver in the air conditioner.

MODE SELECTOR BUTTON

Press this button to modify the air conditioner mode.

(heating)

blinking or fixed

The air conditioner makes the room warmer.

(automatic)

When this setting is selected, the air conditioner calculates the difference between the thermostat setting and the room temperature and automatically switches to the "cool" or "heat" mode.

TEMPERATURE SETTING BUTTONS

- (cooler)

Press this button to decrease the set temperature.

+ (warmer)

Press this button to increase the set temperature.

"FAN" BUTTON (fan speed)

- Fan speed is automatically selected by the microcomputer.
- High speed.
- Medium speed.
- Low speed.

NIGHT/ECO BUTTON

Press this button in order to select the NIGHT/ECO mode.

"HIGH POWER" BUTTON

Press this button in order to select the HIGH POWER mode.

CLOCK AND TIMER SETTING BUTTON

Press this button in order to:

- set the clock
- set the ON/OFF timer

For details refer to paragraphs "SETTING THE HOUR" and "SETTING THE TIMER".

HOURS AND MINUTES SETTING BUTTONS

With these buttons is possible to set the clock and the timer. For details refer to paragraphs "SETTING THE HOUR" and "SETTING THE TIMER".

ON/OFF BUTTON

This button turns the air conditioner ON and OFF.

FLAP BUTTON

Press this button in order to select the desired function.

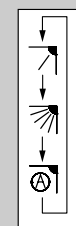

Fixed: six position

Continuous oscillations

Automatically oscillations

IFEEL/IFEEL C SENSOR SELECTOR

Press this button to modify the active setting for room temperature detection (from remote controller to air conditioner and viceversa).

CLEAN/FILTER TiO₂ - MENU BUTTON

Press this button in order to select the mode or to enter the functions menu.

TIMER SELECTION BUTTON

Press this button to select the type of timer to activate. For details refer to paragraph "SETTING THE TIMER".

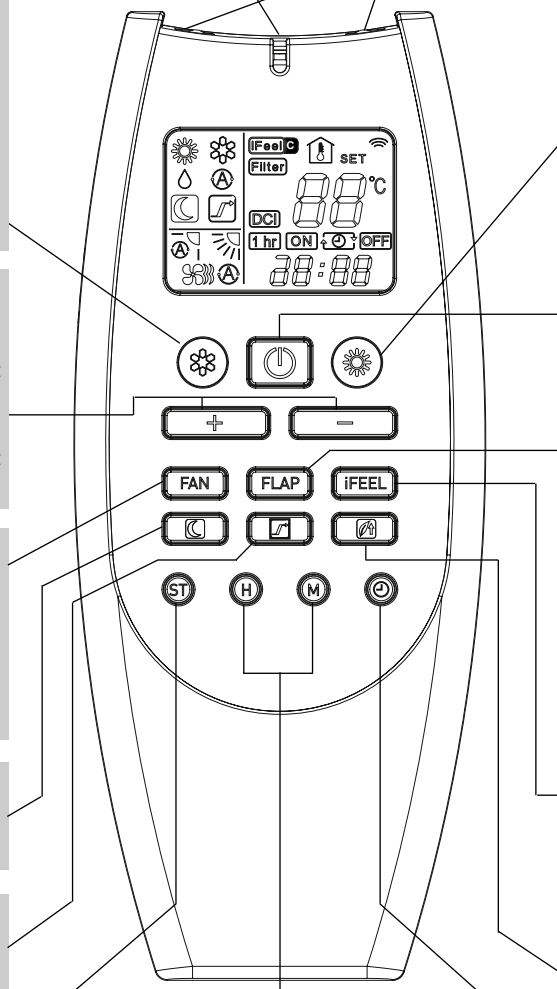



HOW TO SET THE PRESENT TIME

1. Press the button ST three times.
The time indication alone flashes.
2. Press the H button until the present time hour is displayed. Press the M button until the present time minutes are displayed. The display will automatically stop flashing.

COOLING

NOTE

Verify that the unit is connected to the main power and the STANDBY lamp is light up.

1. Set the  selector to COOL (symbol  on the display).
2. Press the +/- buttons (temperature selection) to set the desired temperature (the temperature range is between 32 °C max. and 10 °C min.).

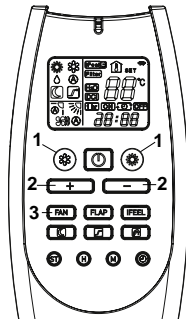



THE DISPLAY SHOWS THE SELECTED TEMPERATURE.



AFTER 5 SECONDS FROM THE REQUIRED TEMPERATURE SETTING THE DISPLAY WILL SHOW THE ROOM TEMPERATURE AGAIN.

3. Press the FAN button to select the fan speed.

HEATING

1. Set the  selector to HEAT (symbol  on the display).
2. Press the +/- buttons (temperature selection) to set the desired temperature (the temperature range is between 32 °C max. and 10 °C min.).



THE DISPLAY SHOWS THE SELECTED TEMPERATURE.



AFTER 5 SECONDS FROM THE REQUIRED TEMPERATURE SETTING THE DISPLAY WILL SHOW THE ROOM TEMPERATURE AGAIN.

3. Press the FAN button to select the fan speed.

NOTE

For several minutes after the start of heating operation, the indoor fan will stop until the indoor heat exchanger coil has warmed up sufficiently. This is because the COLD DRAFT PREVENTION SYSTEM is operating. During this period, the STANDBY lamp remains lit.





DEFROSTING OF OUTDOOR UNIT HEAT EXCHANGER

When the outdoor temperature is low, frost or ice may appear on the heat exchanger coil, reducing the heating performance. When this happens, a protection function for the heat exchanger defrosting is activated. During this function operation, the fan of the indoor unit stops. Heating operation restarts after several minutes. (This interval will vary slightly depending on the room and outdoor temperature).

HEATING PERFORMANCE

A heat pump conditioner heats a room by taking heat from outside air. The heating efficiency will fall off when the outdoor temperature is very low. If enough heat is not obtained with this air conditioner, use another heating appliance in conjunction with it.

AUTOMATIC OPERATION

1. Set the  or  selector to AUTO (symbol  on the display; also the symbol  or  remains displayed).
2. Press the +/- buttons (temperature selection) to set the desired temperature (the temperature range is between 32 °C max. and 10 °C min.).



THE DISPLAY SHOWS THE SELECTED TEMPERATURE.



AFTER 5 SECONDS FROM THE REQUIRED TEMPERATURE SETTING THE DISPLAY WILL SHOW THE ROOM TEMPERATURE AGAIN.

When this setting is selected, the air conditioner calculates the difference between the thermostat setting and the room temperature and automatically switches to the COOL or HEAT mode as appropriate, regardless of the symbol displayed.

3. Press the FAN selector button to the setting you want.

Example of operation diagram in the  (Auto) mode with the set room temperature at 23°C.

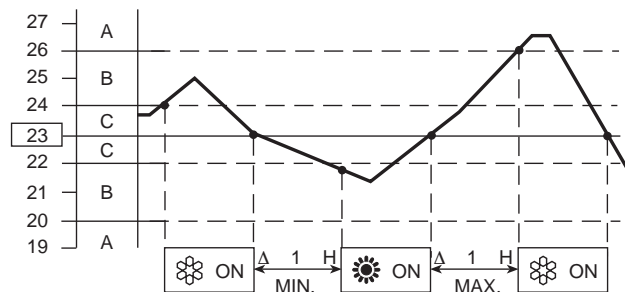

NOTE

The air conditioner changes the operation mode (from cool to heat or vice versa, if one of the following conditions occurs:

- **ZONE A:** changes if the difference between the room temperature and the temperature set on the remote control unit is at least 3°C.
- **ZONE B:** changes if the difference between the room temperature and the temperature set on the remote control unit is at least 1°C, one hour after the compressor stop.
- **ZONE C:** never changes if the difference between the room temperature and the temperature set on the remote control unit is no more than 1°C.

During Automatic Operation, if the fan switch is in the lower position (see paragraph "Adjusting the air flow direction"), the distribution of air flow between upper and lower grille, is adjusted as follows:



- **In heating**, the air flow rate of the lower grille is prevalent.
- **In cooling**, the air flow rate of the upper grille is prevalent.

AUTOMATIC OPERATION IN MULTISPLIT CONFIGURATION

When the air conditioning system configuration is multisplit and there is more than one indoor unit connected, the automatic mode operates as follows:

- the first unit that switches on the system also decides the operation mode (cooling or heating) for all the other units that will be switched on after the first one;
- when the system has been switched on in cooling mode and one unit is activated in heating mode, an error will be signaled for this unit (wrong operating mode). If the same unit is switched on in "automatic" mode and the desired temperature is lower than the detected ambient temperature, the unit will operate in cooling mode, like the other units of the system; on the contrary, if the desired temperature is higher than the detected one, the unit will operate in fan mode;
- when the system has been switched on in heating mode and one unit is activated in cooling mode, an error will be signaled for this unit (wrong operating mode). If the same unit is switched on in "automatic" mode and the desired temperature is higher than the detected ambient temperature, the unit will operate in heating mode, like the other units of the system; on the contrary, if the desired temperature is lower than the detected one, the unit will operate in fan mode.

DEHUMIDIFYING (DRY)

1. Set the  button to DRY. The icon  is displayed.
2. Press the +/- buttons (temperature selection) to set the desired temperature (the temperature range is between 32 °C max. and 10 °C min.).

NOTE

Dehumidifying operation is adjusted both by the difference between set temperature and air temperature, and by the value of relative humidity, detected by the sensor.



THE DISPLAY SHOWS THE SELECTED TEMPERATURE.

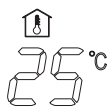



AFTER 5 SECONDS FROM THE REQUIRED TEMPERATURE SETTING THE DISPLAY WILL SHOW THE ROOM TEMPERATURE AGAIN.

NOTE

- Use DRY operation when you want to reduce the humidity in the room.
- During DRY operation, the fan speed is automatically set (Remote control lamp  is ON) to prevent overcooling.
- Dry operation is not possible if the indoor temperature is 10 °C or less.

FAN ONLY

If you want to make air circulate without any temperature control, press  button until only the  fan symbol appears on the display.

ADJUSTING THE FAN SPEED

AUTOMATIC



Simply set the FAN selector to the  position. A microcomputer automatically controls the fan speed when the AUTO mode is selected. When the air conditioner starts operating, in heating or cooling, the fan speed varies (high - medium - low - very low) according to the thermal load of the room.

NOTE



The automatic speed is not available in FAN ONLY mode.

MANUAL

If you want to manually adjust speed just set the FAN selector as desired.

 High speed  Med. speed  Low speed





CLEAN/FILTER TiO₂

Pressing the  button (symbol  on the display) the filtering system with titanium dioxide is activated; this is very effective to prevent bad odours and to eliminate bacteria and micro-organisms.

NOTE

The filter is active only if the internal fan is operating.

NIGHT MODE / ENERGY SAVING

- This mode enables you to save energy.
1. Set the  or  selector to cool, dry or heat.
 2. Press the  button.
 3. The  mark appears on the display. Press the button again to release the function.

What does the NIGHT mode mean?

When you select the NIGHT mode, the air conditioner will modify automatically the set temperature after 60 minutes. This enables you to save energy without sacrificing your comfort.

OPERATING MODE	SET TEMPERATURE CHANGE
Heating	Lowered by 2 °C
Cooling and Dry	Raised by 1 °C

NOTA

During the NIGHT mode the internal fan speed is automatically lowered and reduces the noise.

HIGH POWER MODE

When this mode is active the internal fan speed is set automatically and the air conditioner operates at the maximum power in the selected operating mode (cooling or heating).

NOTE

During the high power operation the room temperature could not correspond to the set temperature.

SETTING THE TIMER

A) HOW TO SET THE ON TIME

1. Press the ST button once.
The ON and time indications flash.
2. Press the H button until the designed hour is displayed.
Press the M button until the designed minutes are displayed. The display will change automatically back to show the present time after 10 sec.
3. Press the ON/OFF button to start the air conditioner.
4. Press the  button to activate the ON timer.

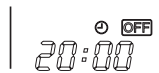
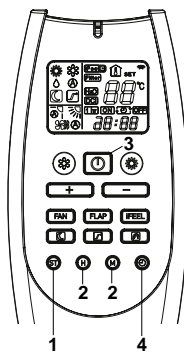
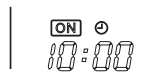

B) HOW TO SET THE OFF TIME

1. Press the ST button twice.
The OFF and time indications flash.
2. Press the H button until the designed hour is displayed.
Press the M button until the designed minutes are displayed. The display will change automatically back to show the present time after 10 sec.
3. Press the ON/OFF button to start the air conditioner.
4. Press the  button two times to activate the OFF timer.

C) HOW TO SET A PROGRAM FOR DAILY ON/OFF OPERATION (OR VICEVERSA)

1. Set the timer ON/OFF as shown in A) and B).
2. Press the ON/OFF button to start the air conditioner.
3. Press three times the  button to activate the DAILY timer.

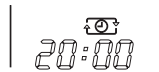

NOTE

After timer setting, press ST button in order to check the ON/OFF setting time.

SETTING THE 1 HOUR TIMER

This function causes the unit to operate for one hour at the set conditions, regardless of whether the unit is on or off.

TIMER SETTING PROCEDURE.

- Press four times the  button. The 1 HOUR TIMER mark will appear on the display.



CANCELLATION PROCEDURE

- Press the ON/OFF button to turn the air conditioner off.
- Wait for the indoor unit to stop operating.
- Press the ON/OFF button again to turn the air conditioner on.

SETTING THE HOLIDAY TIMER

The Holiday Timer function allows you to activate the indoor unit (either it is the only one of a monosplit system or one unit of a multisplit system), with a delay up to 99 days you can set for the Daily Timer, On Timer, Off Timer functions (not available for 1 HOUR TIMER) already explained in this manual.

With this function you can set the air conditioner to be switched on again after a long week end, a holiday of one week or more, ecc...

To activate this function you have to follow the following steps in order :

1. Keep pressed the button "TIMER SELECTION" of the remote control unit (clock figure) for more than 6~7 seconds. In this way you enter the menu to select the number of days of delay.
2. Select the desired timer (Daily Timer, On Timer, Off Timer) pressing on the same button "TIMER SELECTION".
3. Set the desired number of days of delay using the button "+".
4. Keep pressed again the button "TIMER SELECTION" for more than 6~7 seconds. You enter again the normal menu of the remote control unit.

At this point, the symbol of the desired timer will flash and the selected timer will be activated only after the set number of delay days.

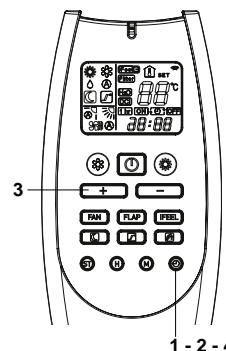

ADJUSTING THE AIR FLOW DIRECTION

HORIZONTAL (manual)

The horizontal air flow can be adjusted by moving the vertical vanes to the left or right, as indicated in the following figures.

This air conditioner is equipped with two air outlet grilles: the upper grille with flap and the lower grille. It is possible to let the fan of the lower grille run or stop by moving the switch, placed inside the air intake grille panel, as shown in the figure.

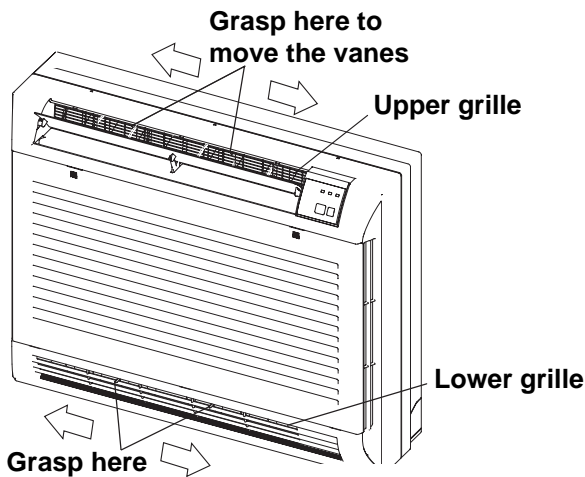
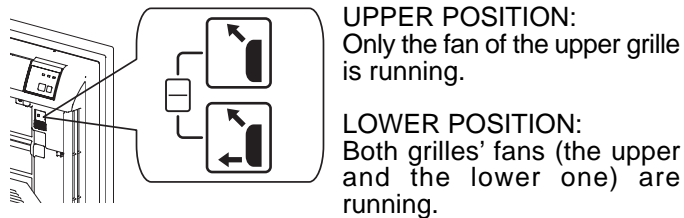

VERTICAL (with remote control unit)

Make sure that the remote control unit has been turned on. Press the FLAP button to select the flap function



Fixed:
six
position

Continuous
oscillations

Automatic
oscillations

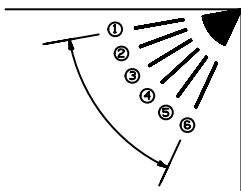

FLAP	MODE

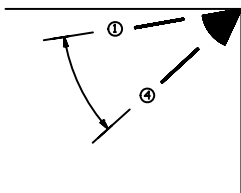

FLAP	MODE

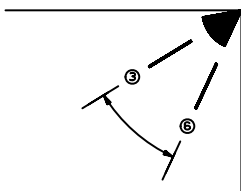

FLAP	MODE

NOTES

- The flap automatically closes when the unit is off.
- When the unit starts in heating operation, the fan stops and the flap is in the 4 position (if automatic oscillation is selected) until the air being blown out of the unit begins to warm. Once the air warms up, the flap position and fan speed change to the settings specified with the remote control.



CAUTION

Do not move the flap with your hands when the air conditioner is running.



CAUTION

- Use the FLAP button on the remote control to adjust the position of the flap. If you move the flap by hand, the actual flap position and the flap position on the remote control may no longer match. If this should happen, shut off the unit, wait for the flap to close, and then turn on the unit again; the flap position will now be normal again.
- Do not have the flap pointed down during cooling operation. Condensation may begin to form around the air vent and drip down.

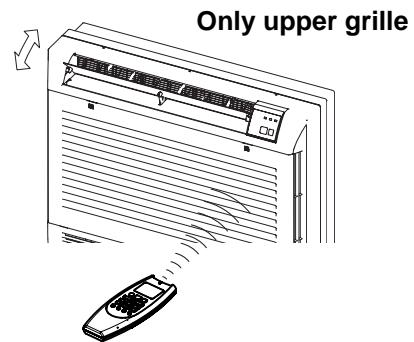

HOW TO ADJUST THE FLAP DIRECTION

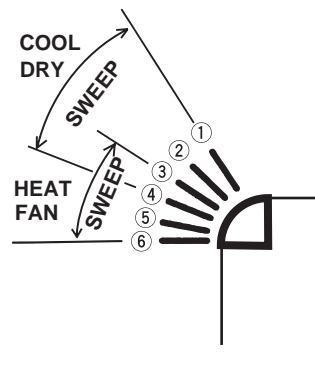

CAUTION

Set vertical vanes to the front position during COOLING/DRY operation if humidity is high. If the vertical vanes are set to the left-most or right-most position, condensation will form around the air outlet and drip off.

OPERATION WITHOUT THE REMOTE CONTROL UNIT

If you have lost the remote control unit or it has troubles, follow the steps below.

1. WHEN THE AIR CONDITIONER IS STOPPED

If you want to turn on the air conditioner press the OPERATION button (ON/OFF).

NOTE

The air conditioner will start in **HIGH fan speed**. The temperature setting is **25°C** for cooling mode and **21°C** for heating mode.

2. WHEN THE AIR CONDITIONER IS RUNNING

If you want to turn off the air conditioner press the OPERATION button (ON/OFF).

NOTE

Power failure during operation.

In the event of power failure, the unit will stop. When the power is resumed, the unit will restart automatically after 3 minutes.

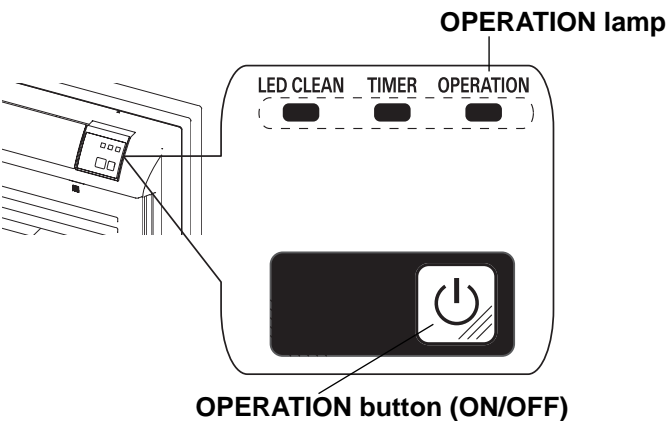

AIR FILTER

The filter behind the front panel should be checked and cleaned at least once every two weeks.

HOW TO REMOVE THE FILTER

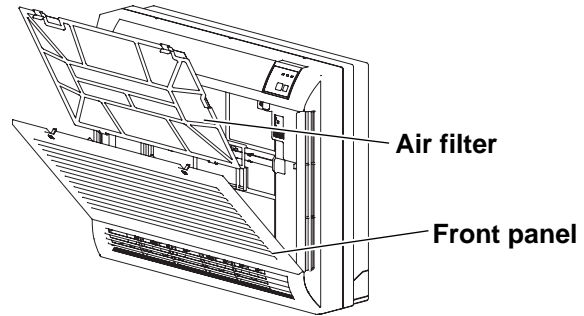

1. Open the front panel pushing on the two points "PUSH" and then pulling towards you.
2. Remove the air filter as shown in the figure. Clean it.
3. Replace the filter and close the front panel.

FILTER CLEANING

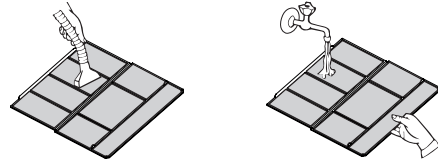

Use a vacuum cleaner to remove light dust. If there is sticky dust on the filter, wash the filter in lukewarm, soapy water, rinse it in clean water, and dry it.

CARE AND CLEANING



WARNING

- Maintenance operations must be carried out by specially trained personnel.
- For safety, be sure to turn the air conditioner off and also to disconnect the power before cleaning.
- Do not pour water on the indoor unit to clean it. This will damage the internal components and cause an electric shock hazard.

CASING AND GRILLE (INDOOR UNIT)

Clean the casing and grille of the indoor unit with a vacuum cleaner brush, or wipe them with a clean, soft cloth.

If these parts are stained, use a clean cloth moistened with a mild liquid detergent.

When cleaning the grille, be careful not to force the vanes out of place.



CAUTION

- Never use solvents, or harsh chemicals when cleaning the indoor unit. Do not wipe the plastic casing using very hot water.
- Some metal edges and the vanes are sharp and may cause injury if handled improperly; be especially careful when you clean these parts.
- The internal coil and other components of the outdoor unit must be cleaned every year. Consult your dealer or service centre.

TIPS FOR ENERGY SAVING

DO NOT:

- Block the air intake and outlet of the unit. If they are obstructed, the unit will not work well, and may be damaged.
- Let direct sunlight into the room. Use sunshades, blind or curtain.

DO:

- Always try to keep the air filter clean. A clogged filter will impair the performance of the unit.
- To prevent conditioned air from escaping, keep windows, doors and any other openings closed.

TROUBLESHOOTING



WARNING

- The use of portable telephones near the air conditioner may cause disturbance to its normal operation and must be avoided. In case abnormal operation is noticed, (OPERATION lamp lights, but the air conditioner will not run) to restore normal operation turn-off electric supply for about 3 minutes, by disconnecting the main switch or the wall plug, then start again the air conditioner.

If your air conditioner does not work properly, first check the following points before requesting service.

If it still does not work properly, contact your dealer or service centre.

Trouble: the air conditioner does not run at all.

Possible cause:

1. Power failure.
2. Leakage breaker tripped.
3. Operation button is OFF.
4. Batteries in remote control unit have run down.

Remedy:

1. Restore power.
2. Contact service centre.
3. Press the button again.
4. Replace batteries.

Trouble: Poor cooling or heating performance.

Possible cause:

1. Dirty or clogged air filters.
2. Heat source or many people in room.
3. Doors and/or windows are open.
4. Obstacle near air intake or air discharge port.
5. The set temperature on the remote control unit is too high.
6. Outdoor temperature is too low (heat pump version).
7. Defrosting system does not work (heat pump version).

Remedy:

1. Clean air filters to improve airflow.
2. Eliminate heat source if possible.
3. Shut them to keep the heat or cold out.
4. Remove it to ensure good airflow.
5. Set the right temperature on the remote control unit.
6. Try to use a back-up heater.
7. Consult your dealer.

Trouble: Clicking sound is heard from the air conditioner.

Possible cause:

1. During operation, any plastic parts may expand or shrink due to a sudden temperature change. In this event, a clicking sound may occur.

Remedy:

1. This is normal, and the sound will disappear when an even temperature is settled.

AUTO-DIAGNOSIS

LEDS			POSSIBLE CAUSE	REMEDY
STANDBY	OPERATION	TIMER		
F	F	O	Defective indoor unit room sensor	Contact service centre
O	F	F	Defective Indoor unit coil sensor	Contact service centre
F	F	F	Communication trouble between indoor and outdoor unit	Contact service centre
F	O	O	Outdoor unit trouble	Contact service centre
F	●	F	Unit has not been addressed for Multisplit System (see Installation Instruction)	Set the unit's address with the remote control
			Operating mode selected is not compatible with the Multisplit System (ex. heating mode has been selected, when the system was in cooling mode, or vice versa).	Select the correct mode, compatible with the system
O	F	O	Malfunctioning of the condensate drainage system	Contact service centre

O = LED OFF ● = LED ON F = Flashing LED

EXPLANATION AND USE OF THE REMOTE CONTROL UNIT'S MICROSWITCHES - SIGNIFICATO E UTILIZZO DEI MICROINTERRUTTORI DEL TELECOMANDO - SIGNIFICATION ET UTILISATION DES INTERRUPTEURS DE LA TELECOMMANDE - BEDEUTUNG UND BENUTZUNG DER FERNBEDIENUNGSSCHALTER - SIGNIFICADO Y USO DE LOS INTERRUPTORES DEL MANDO A DISTANCIA

EG Switch 1 and 2: These switches are used to match the remote control with the specific internal units.

Switch 3 and 4: these switches have been provided for future use; they have no function today. Keep them in OFF position.

Switch 5 and 6: these switches set the remote control in WIRELESS or WIRED mode. Default position is ON (WIRELESS mode). For WIRED control, remove the batteries and set in OFF position.

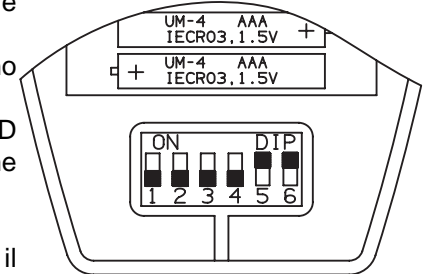

I Microinterruttori 1 e 2: Questi microinterruttori vengono usati per abbinare il telecomando con le unità interne specifiche.

Microinterruttori 3 e 4: questi microinterruttori sono stati predisposti per un uso futuro; al momento non hanno nessuna funzione. Lasciarli in posizione OFF.

Microinterruttori 5 e 6: questi microinterruttori impostano il telecomando in modalità INFRAROSSI o A FILO. La posizione di default é ON (modalità INFRAROSSI). Per il comando A FILO, rimuovere le batterie e mettere in posizione OFF.

F Interrupteurs 1 et 2: Ces interrupteurs sont utilisés pour coupler la télécommande avec les unités intérieures spécifiques.

Interrupteurs 3 et 4: ces interrupteurs ont été développés pour une utilisation future; actuellement n'ont aucune fonction. Les laisser en position OFF.

Interrupteurs 5 et 6: ces interrupteurs règlent la télécommande en mode INFRAROUGES ou CABLEE. La position normale est ON (mode INFRAROUGES). Pour le commande CABLEE, enlever les piles et régler-les en position OFF.

D Schalter 1 und 2: Diese Schalter werden verwendet, um die Fernbedienung auf die spezifische Inneneinheiten zu entsprechen.

Schalter 3 und 4: diese Schalter wurden für den zukünftigen Gebrauch entwickelt; gegenwärtig haben sie keine Funktion. Lassen Sie sie auf der Position OFF.

Schalter 5 und 6: diese Schalter stellen die Fernbedienung wie INFRAROT oder KABEL ein. Die normale Position ist auf ON (INFRAROT). Für die Kabel-Funktion, entfernen Sie die Batterien und stellen Sie sie auf die Position OFF.

E Interruptores 1 y 2: Estos interruptores se utilizan para que coincida el mando a distancia con las unidades internas específicas.

Interruptores 3 y 4: estos interruptores se han desarrollado para su uso futuro; actualmente no tienen ninguna función. Dejarlos en la posición OFF.

Interruptores 5 y 6: estos interruptores regulan el mando a distancia en modo INFRARROJOS o CON CABLE. La posición normal está en ON (modo INFRARROJOS). Para la función CON CABLE, remover las pilas y ajustarlos en la posición OFF.

EG HOW TO REMOVE BATTERIES

- Remove the lid.
- Press the battery toward the negative end and lift it out by its positive end (as shown in the figure).
- Remove the other battery in the same way.

I COME RIMUOVERE LE BATTERIE

- Rimuovere il coperchio.
- Premere la batteria verso il polo negativo ed estrarla dalla parte del polo positivo (come mostrato in figura).
- Rimuovere l'altra batteria allo stesso modo.

F COMMENT ENLEVER LES PILES

- Enlever le couvercle.
- Pousser la pile vers le pôle négatif et enlever le pôle positif (comme représenté dans la figure).
- Enlever l'autre pile de la même manière.

D WIE DIE BATTERIEN ZU ENTFERNEN

- Die Abdeckung entfernen.
- Drücken Sie die Batterie nach dem negativen Pol und entfernen Sie sie vom positiven Pol (wie in Abbildung gezeigt ist).
- Entfernen Sie ebenso die andere Batterie.

E COMO REMOVER LAS PILAS

- Remover la tapa.
- Apretar la pila hacia el polo negativo y remover el polo positivo (como en figura).
- Remover así también la otra pila.

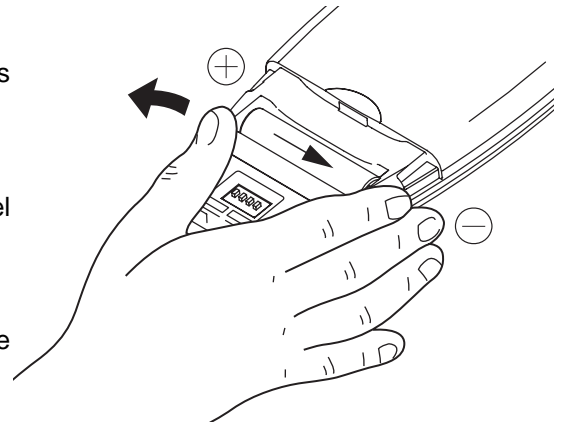

F-GAS Regulation (EC) No. 842/2006

EG Do not vent R410A into atmosphere: R410A is a fluorinated greenhouse gas, covered by Kyoto Protocol, with a Global Warming Potential (GWP) = 1975.

I Non disperdere R410A nell'atmosfera: R410A è un gas fluorinato a effetto serra, coperto dal protocollo di Kyoto, con potenziale di riscaldamento globale (GWP) = 1975.

F Ne déchargez pas R410A dans l'atmosphère : R410A est un gaz fluoré à effet de serre, couvert par le protocole de Kyoto, avec un potentiel de chauffage global (GWP) = 1975.

D Zerstreuen Sie R410A in Atmosphäre nicht: R410A ist ein fluoriertes Gas, abgedeckt durch Kyoto Protokoll, mit einem globalen wärmenden Potential (GWP) = 1975.

E No expulsar R410A a la atmósfera: el R410A es un gas fluorado de efecto invernadero, cubierto por el protocolo de Kyoto, con potencial de calentamiento global (GWP) = 1975.



INFORMATION FOR CORRECT DISPOSAL OF THE PRODUCT IN ACCORDANCE WITH THE EUROPEAN DIRECTIVE 2002/96/EC

At the end of its working life this equipment must not be disposed of as an household waste. It must be taken to special local community waste collection centres or to a dealer providing this service. Disposing of an electrical and electronic equipment and its batteries separately avoids possible negative effects on the environment and human health deriving from an inappropriate disposal and enables its components to be recovered and recycled to obtain significant savings in energy and resources. In order to underline the duty to dispose of this equipment and batteries separately, the product is marked with a crossed-out dustbin.



INFORMAZIONE PER IL CORRETTO SMALTIMENTO DEL PRODOTTO AI SENSI DELLA DIRETTIVA EUROPEA 2002/96/CE

Alla fine della sua vita utile questo apparecchio non deve essere smaltito insieme ai rifiuti domestici. Deve essere consegnato presso appositi centri di raccolta differenziata oppure presso i rivenditori che forniscono questo servizio. Smaltire separatamente un apparecchio elettrico ed elettronico e le relative batterie consente di evitare possibili effetti negativi sull'ambiente e sulla salute umana derivanti da uno smaltimento inadeguato e permette di recuperare e riciclare i materiali di cui è composto, con importanti risparmi di energia e risorse. Per sottolineare l'obbligo di smaltire separatamente queste apparecchiature e le batterie, sul prodotto è riportato il simbolo del cassonetto barrato. Lo smaltimento abusivo del prodotto da parte dell'utente comporta l'applicazione delle sanzioni amministrative previste dalla normativa vigente.



AVERTISSEMENT POUR L'ELIMINATION CORRECT DU PRODUIT AUX TERMES DE LA DIRECTIVE EUROPEENNE 2002/96/CE

Au terme de son utilisation cet équipement ne doit pas être éliminé avec les ordures ménagères. Le produit doit être remis à l'un des centres de collecte sélective locaux ou auprès des revendeurs assurant ce service. Eliminer séparément un équipement électrique et électronique et ses piles permet d'éviter des potentielles retombées négatives pour l'environnement et la santé humaine dérivant d'une élimination incorrecte et permet de récupérer les matériaux qui le composent dans le but d'une économie importante en termes d'énergie et de ressources. Pour rappeler l'obligation d'éliminer séparément ces équipements et les piles, le produit porte le symbole d'un caisson à ordures barré.



HINWEIS FÜR DIE KORREKTE ENTSORGUNG DES PRODUKTS IN ÜBEREINSTIMMUNG MIT DER EUROPÄISCHEN RICHTLINIE 2002/96/EG

Am Ende seiner Nutzzeit darf dieses Gerät nicht zusammen mit dem Hausmüll beseitigt werden. Es darf zu den örtlichen Sammelstellen oder zu den Fachhändlern, die einen Rücknahmeservice anbieten, gebracht werden. Die getrennte Entsorgung eines elektrischen und elektronischen Gerätes und seiner Batterien vermeidet mögliche negative Auswirkungen auf die Umwelt und die menschliche Gesundheit, die durch eine nicht vorschriftsmäßige Entsorgung bedingt ist. Zudem ermöglicht wird die Wiederverwertung der Materialien, aus denen sich das Gerät zusammensetzt, was wiederum eine bedeutende Einsparung an Energie und Ressourcen mit sich bringt. Zur Erinnerung an die Verpflichtung, die diese Geräte und die Batterien getrennt zu beseitigen, ist das Produkt mit einer durchgestrichen Mülltonne gekennzeichnet.



ADVERTENCIA PARA LA ELIMINACIÓN CORRECTA DEL PRODUCTO SEGÚN ESTABLECE LA DIRECTIVA EUROPEA 2002/96/CE

Al final de su vida útil, este equipo no debe eliminarse junto a los desechos domésticos. Debe entregarse a centros específicos de recogida diferenciada locales o a distribuidores que facilitan este servicio. Eliminar por separado un equipo eléctrico y electrónico y sus pilas significa evitar posibles consecuencias negativas para el medio ambiente y la salud derivadas de una eliminación inadecuada y permite reciclar los materiales que lo componen, obteniendo así un ahorro importante de energía y recursos. Para subrayar la obligación de eliminar por separado estos equipos y las pilas, en el producto aparece un contenedor de basura tachado.

In order to carry on a constant improvement, our products can be modified without prior notice.
Per garantire un costante miglioramento dei nostri prodotti, ci riserviamo di modificarli senza preavviso.
Par souci d'amélioration constante, nos produits peuvent être modifiés sans préavis.
Unsere Produkte werden laufend verbessert und können Vorankündigung abgeändert Werden.
En el interés de mejoras constantes, nuestros productos pueden modificarse sin aviso previo.

 **Technibel**
UNE AVANCE DANS L'AIR DU TEMPS

R.D. 28 Reyrieux BP 131 - 01601 Trévoux CEDEX France
Tél. 04.74.00.92.92 - Fax 04.74.00.42.00
R.C.S. Bourg-en-Bresse B 759 200 728