

Save These Instructions!
Conserver ce mode d'emploi
Bewahren Sie bitte diese
Bedienungsanleitung auf.
Conservate queste istruzioni
Guarde estas instruções
Φυλάξτε τις οδηγίες αυτές
Guarde estas instrucciones



This air conditioner uses the new refrigerant R410A.



SEMI-CONCEALED	CEILING-MOUNTED	WALL-MOUNTED	CONCEALED DUCT
(4-WAY)			(Standard Static Pressure)
CAFP 124 R	SPAFP 124 R	MAFP 125 R	DSAFP 124 R
CAFP 164 R	SPAFP 164 R	MAFP 165 R	DSAFP 164 R
CAFP 184 R	SPAFP 184 R	MAFP 185 R	DSAFP 184 R
CAFP 254 R	SPAFP 255 R	MAFP 225 R	DSAFP 255 R
CAFP 364 R	SPAFP 365 R		DSAFP 365 R
CAFP 484 R	SPAFP 485 R		DSAFP 485 R

Split System Air Conditioner

• **INSTRUCTION MANUAL**

EG

Climatiseur Split System

• **MODE D'EMPLOI**

F

Split-System-Klimagerät

• **BEDIENUNGSANLEITUNG**

D

Condizionatore d'Aria Split

• **ISTRUZIONI PER L'USO**

I

Aparelho de Ar Condicionado Sistema Split

• **MANUAL DE INSTRUÇÕES**

P

Κλιματιστικό Δύο Μονάδων

• **ΕΓΧΕΙΡΙΔΙΟ ΟΔΗΓΙΩΝ**

GR

Acondicionador de Aire de Dos Unidades

• **MANUAL DE INSTRUCCIONES**

ES

Pub. OI-85464189722000

© 2005

Contents

	Page
Product Information.....	2
Alert Symbols.....	2
Installation Location.....	3
Electrical Requirements.....	3
Safety Instructions.....	3
Names of Parts (Indoor Unit).....	4
Wireless Remote Control Unit (Optional parts).....	5
Parts Name and Functions.....	5
Receiver.....	8
Operation.....	9
Using the Wireless Remote Control Unit.....	11
Address Settings.....	13
Emergency Operation.....	15
Troubleshooting.....	17
Wired Remote Control Unit (Optional parts).....	18
Parts Name and Functions.....	18
Display.....	21
Operation.....	22
Adjusting the Airflow Direction.....	24
Adjusting the Airflow Direction for Multiple Indoor Units Using a Single Remote Control Unit.....	27
Special Remarks.....	28
Setting the Timer.....	29
Care and Cleaning.....	31
Troubleshooting.....	33
Tips for Energy Saving.....	33

Product Information

If you have problems or questions concerning your Air Conditioner, you will need the following information. Model and serial numbers are on the nameplate on the bottom of the cabinet.

Model No. _____ Serial No. _____
 Date of purchase _____
 Dealer's address _____
 Phone number _____

DECLARATION OF CONFORMITY

This product is marked « CE » as it satisfies EEC Directive No. 89/336/EEC, 73/23/EEC and 93/68/EEC, and conforms with following standards.
 This declaration will become void in case of misuse and/or from non observance though partial of Manufacturer's installation and/or operating instructions.

Note: This air conditioner uses the new refrigerant R410A.

Alert Symbols

The following symbols used in this manual, alert you to potentially dangerous conditions to users, service personnel or the appliance:



WARNING

This symbol refers to a hazard or unsafe practice which can result in severe personal injury or death.



CAUTION

This symbol refers to a hazard or unsafe practice which can result in personal injury or product or property damage.

Installation Location

- We recommend that this air conditioner be installed properly by qualified installation technicians in accordance with the Installation Instructions provided with the unit.
- Before installation, check that the voltage of the electric supply in your home or office is the same as the voltage shown on the nameplate.



WARNING

- Do not install this air conditioner where there are fumes or flammable gases, or in an extremely humid space such as a greenhouse.
- Do not install the air conditioner where excessively high heat-generating objects are placed.

Avoid: To protect the air conditioner from heavy corrosion, avoid installing the outdoor unit where salty sea water can splash directly onto it or in sulphurous air near a spa.

Electrical Requirements

1. All wiring must conform to the local electrical codes. Consult your dealer or a qualified electrician for details.
2. Each unit must be properly grounded with a ground (or earth) wire or through the supply wiring.
3. Wiring must be done by a qualified electrician.



CAUTION

To warm up the system, the power mains must be turned on at least five (5) hours before operation. Leave the power mains ON unless you will not be using this appliance for an extended period.

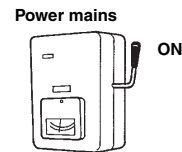

Safety Instructions

- Read this Instruction Manual carefully before using this air conditioner. If you still have any difficulties or problems, consult your dealer for help.
- This air conditioner is designed to give you comfortable room conditions. Use this only for its intended purpose as described in this Instruction Manual.

EG



WARNING

- Never touch the unit with wet hands.
- Never use or store gasoline or other flammable vapor or liquid near the air conditioner — it is very dangerous.
- This air conditioner has no ventilator for intaking fresh air from outdoors. You must open doors or windows frequently when you use gas or oil heating appliances in the same room, which consume a lot of oxygen from the air. Otherwise there is a risk of suffocation in an extreme case.



CAUTION

- Do not turn the air conditioner on and off from the power mains switch. Use the ON/OFF operation button.
- Do not stick anything into the air outlet of the outdoor unit. This is dangerous because the fan is rotating at high speed.
- Do not let children play with the air conditioner.
- Do not cool or heat the room too much if babies or invalids are present.

Names of Parts (Indoor Unit)

INDOOR UNIT

SEMI-CONCEALED CAFP type (4-WAY)

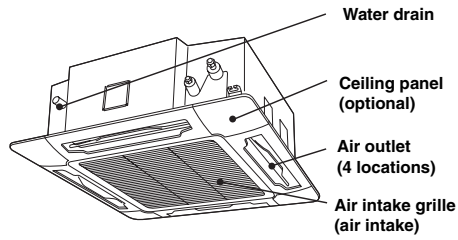

CEILING-MOUNTED SPAFP type

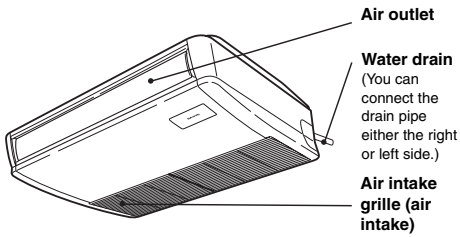

WALL-MOUNTED MAFP type

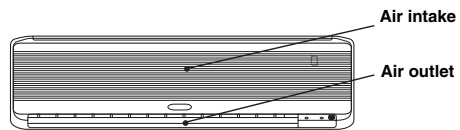

CONCEALED DUCT DSAFP type (standard static pressure)

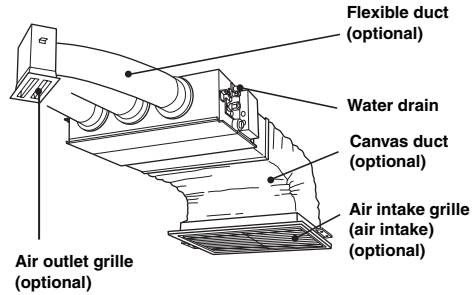

REMOTE CONTROL UNITS

(Wired type: available for all indoor units)



(Wireless type: available for all indoor units)



Wireless Remote Control Unit (Optional parts)

Parts Name and Functions

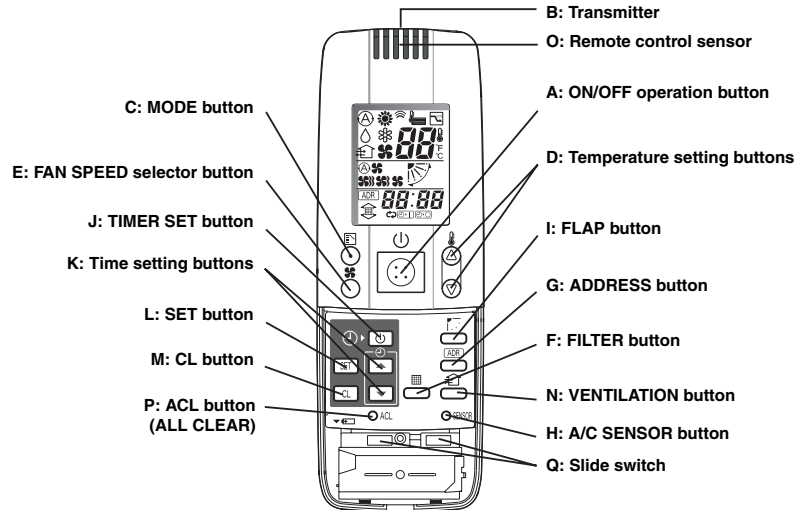

















NOTE The illustration above pictures the wireless remote control unit after the cover has been lowered and removed.













A: ON/OFF operation button	This button is for turning the air conditioner on and off.
B: Transmitter	When you press the buttons on the wireless remote control unit, the mark appears in the display to transmit the setting changes to the receiver in the air conditioner.
C: MODE button	Use this button to select one of the following five operating modes. (AUTO) : Used to automatically set cooling or heating operation. Only for single heat pump type (HEAT) : Used for normal heating operation. Only for heat pump type (DRY) : Used for dehumidifying without changing the room temperature. (COOL) : Used for normal cooling operation. (FAN) : Used to run the fan only, without heating or cooling operation.
D: Temperature setting buttons	: Press this button to increase the temperature setting. : Press this button to decrease the temperature setting.
E: FAN SPEED selector button	(AUTO) : The air conditioner automatically decides the fan speeds. (HI.) : High fan speed (MED.) : Medium fan speed (LO.) : Low fan speed

EG

Parts Name and Functions (continued)

F: FILTER button	<p>If a separately installed signal receiver is being employed, this button is used to turn off its filter lamp. When the filter lamp has lighted, first clean the filter, and then press the FILTER button to turn off the filter lamp.</p> <p>When a wired remote control unit and wireless remote control unit are both used, the filter sign on the wired remote control unit will be appeared. When this happens, first clean the filter, and then press the FILTER button on one of the remote control units to turn off the filter sign.</p>												
G: ADDRESS button	<p>When a multiple number of indoor units that can be operated by the wireless remote control unit have been installed in the same room with a multi-unit or single-unit installation, this button enables addresses to be set in order to prevent the sending of signals to the wrong indoor unit. Each of up to six indoor units can be controlled separately using its own wireless remote control unit by matching the number of the address switch on the operation area of the indoor unit and the number used for the address of its remote control unit. (The indoor units cannot be controlled separately when they are used in a flexible combination format, simultaneous operation of multi units format or any other such format since they will all operate at the same time.)</p> <p>NOTE When the batteries are replaced, the address setting returns to "ALL", and so please make the setting again.</p>												
H: A/C SENSOR button	<p>When you press this button (use a small-tipped object such as a ballpoint pen), the  indication will disappear at the display. And the room temperature is detected by the sensor which is built in the indoor unit and the air conditioner is controlled accordingly.</p> <p>NOTE If the remote control is located near a heat source, such as a space heater or in direct sunlight, press the A/C SENSOR button to switch to the sensor on the indoor unit.</p>												
I: FLAP button	<p>1. Use this button to set the airflow direction to a specific angle. The airflow direction is displayed on the remote control unit.</p> <table border="1" data-bbox="662 1200 1198 1335"> <thead> <tr> <th>Operation mode</th> <th>Number of airflow direction settings</th> </tr> </thead> <tbody> <tr> <td> (COOL) or  (DRY)</td> <td>3</td> </tr> <tr> <td> (HEAT) or  (FAN)</td> <td>5</td> </tr> <tr> <td> (AUTO)</td> <td></td> </tr> <tr> <td> Cooling mode:</td> <td>3</td> </tr> <tr> <td> Heating mode:</td> <td>5</td> </tr> </tbody> </table> <p>CAUTION</p> <ul style="list-style-type: none"> In the cool mode and dry mode, if the flaps are set in a downward position, condensation may form and drip around the vent. Do not move the flap with your hands. <p>NOTE This function is available for models CAFFP, SPAFP and MAFP.</p> <p>(SWEEP)</p> <p>2. Use this button to make the airflow direction sweep up and down automatically. Press this button several times until the  symbol appears on the display.</p> <p>To stop the swing operation Press the FLAP button again during the flap swing operation to stop the flap at the desired position. Then, the airflow can be set from the top position by pressing the FLAP button again.</p>	Operation mode	Number of airflow direction settings	 (COOL) or  (DRY)	3	 (HEAT) or  (FAN)	5	 (AUTO)		Cooling mode:	3	Heating mode:	5
Operation mode	Number of airflow direction settings												
 (COOL) or  (DRY)	3												
 (HEAT) or  (FAN)	5												
 (AUTO)													
Cooling mode:	3												
Heating mode:	5												

Parts Name and Functions (continued)

	<p>Indicator when swing operation is stopped</p> <table border="1"> <thead> <tr> <th>Fan and heating</th> <th>Cooling and drying</th> </tr> </thead> <tbody> <tr> <td></td> <td></td> </tr> </tbody> </table> <p>During cooling and drying, the flap does not stop at the downward position. Even if the flap is stopped at the downward position during the swing operation, it does not stop until it moves to the third position from the top.</p> <p>NOTE This function is available for models CAFP, SPAFP and MAFP.</p>	Fan and heating	Cooling and drying		
Fan and heating	Cooling and drying				
					
J: TIMER SET button (OFF Timer) (OFF Cycle Timer) (ON Timer)	<p>Use this button while the unit is operating to switch between timer settings.</p> <p>: The air conditioner stops after a preset time elapses.</p> <p>: The air conditioner always stops after a preset time elapses.</p> <p>: The air conditioner starts after a preset time elapses.</p>				
K: Time setting buttons	<p>: Press this button to increase the time.</p> <p>: Press this button to decrease the time.</p>				
L: SET button	Use this button to set the timer.				
M: CL button	Use this button to clear the timer setting.				
N: VENTILATION button	<p>This is used when a ventilation fan (available commercially) is connected. Pressing the VENTILATION button turns the fan on and off. The ventilation fan also turns on and off when the air conditioner unit is turned on and off. (The display of the remote control unit shows “” while the ventilation fan is running.)</p> <p>* If the VENTILATION button is held down for 4 or more seconds when the batteries have been replaced, “” appears on the display, and the ventilation fan can be used.</p>				
O: Remote control sensor	This detects the temperature around the remote control unit when the remote control unit position has been selected using the sensor button.				
P: ACL button (ALL CLEAR)	Puts the wireless remote control unit into pre-operation status. This is used after the batteries have been replaced or when the slide switch setting has been changed.				
Q: Slide switch	This switch is for setting the operation mode of the indoor unit and setting the flaps.				

EG

NOTE

- The wireless remote control unit sends the temperature signal to the air conditioner regularly at five-minute intervals. If the signal from the wireless remote control unit stops for more than ten minutes due to the loss of the wireless remote control unit or other trouble, the air conditioner will switch to the temperature sensor which is built into the indoor unit and control the room temperature. In these cases, the temperature around the wireless remote control unit may differ from the temperature detected at the air conditioner's position.
- When low fan speed is selected and the air conditioner is in cooling operation at a low outdoor temperature of less than 10°C, the air conditioner may automatically switch to medium fan speed to prevent freezing.

Receiver

The signal receivers with the exception of the separately installed signal receiver are mounted on the indoor units.

CAFP type

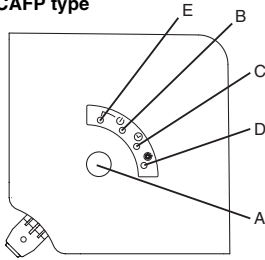

SPAFP type

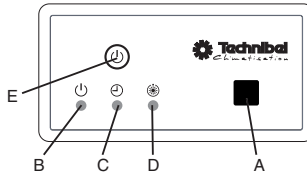

MAFP type

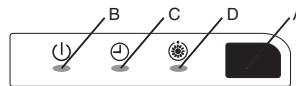

Separately installed signal receiver (DSAFP type)

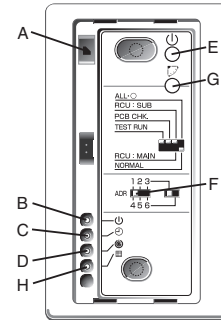

A: Receiver	This section picks up infrared signals from the wireless remote control unit (transmitter).
Indication lamps	One of these lamps will blink when trouble has occurred. When an indicator lamp starts to blink, refer to "Troubleshooting" on page 17.
B: Operation lamp	This lamp lights when the appliance is turned on.
C: Timer lamp	This lamp lights when the system is being controlled by the timer.
D: Standby lamp	<ul style="list-style-type: none"> This lamp lights at the following times during heating operations: <ul style="list-style-type: none"> When operation has started, when the thermostat has been activated, during a defrosting operation The lamp blinks when trouble has occurred.
E: Emergency operation button	This is used when operation cannot be performed due to trouble with or loss of the wireless remote control unit.
F: ADDRESS switch	This switch is used in order to prevent the sending of signals to the wrong indoor unit when a multiple number of indoor units that can be operated by the wireless remote control units have been installed in the same room.
G: SWING button	When this button is pressed, the airflow sweeps up and down automatically.
H: FILTER lamp	This lamp lights to indicate that it is time to clean the filter.

- If two beeps are heard, the operation lamp among the indication lamps has lighted and the timer lamp and standby lamp blink alternately in cases where heat pump models are used, this indicates a cooling/heating mode mismatch and, as such, operation in the desired mode cannot be performed. (The same beeps will be heard and the same operation lamps will light when auto cooling/heating has been selected on a model which does not have the auto cooling/heating function.)
- When local operation has been set to disable because the centralized control mode is established, for instance, pressing the ON/OFF operation button, MODE button or temperature setting buttons results in the sounding of five beeps, and the attempted change in the operation will not be accepted.

Operation

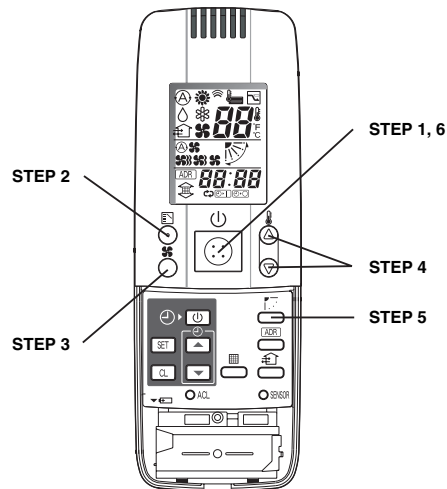
NOTE

- To warm up the system, the power mains must be turned on at least five (5) hours before operation.

STEP 1 To start the air conditioner

Press the operation button (ON/OFF button).

STEP 2 Setting the mode

Press the MODE button to select the mode of your choice.
 [☼ (AUTO), * (HEAT), ◊ (DRY), ❄ (COOL) or 🌀 (FAN)]

STEP 3 Setting the fan speed

Press the FAN SPEED selector button to select the fan speed of your choice.
 [🌀 (AUTO), 🌀 (HI.), 🌀 (MED.) or 🌀 (LO.)]

If AUTO is selected, the fan speed switches automatically.

STEP 4 Setting the temperature

Use the ▼ or ▲ button as appropriate to change the temperature setting as desired.
 (▼ reduces the temperature, and ▲ increases the temperature.)

* The temperature cannot be set during FAN mode operation.

STEP 5 Setting the airflow direction

When more than one indoor unit is connected, the UNIT button is used first to select a unit. Then use the FLAP button to set the airflow direction to a specific angle or to sweep.

STEP 6 To stop the air conditioner

Press the operation button (ON/OFF button) again.

EG

Operation (continued)

Automatic heating and cooling (Only for heat pump type)

The air conditioner automatically performs heating and cooling operation based on the difference between the temperature setting and room temperature. All indoor units in the same refrigerant system can be operated with a single group control.

Simultaneous operation of multiple units (Group control)

Group control is suitable for air conditioning of a large room using multiple air conditioning units.

- One remote control unit can control up to four indoor units.
- All indoor units have the same settings except for the airflow direction.
- The temperature sensors at the indoor unit side are used.

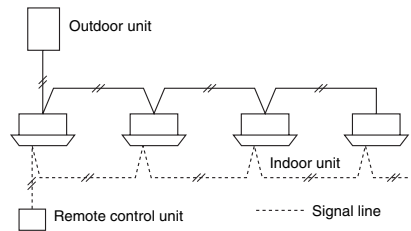

Using the Wireless Remote Control Unit

- Slide switch** This is used to set the operation mode of the indoor units and to set the flaps.
- Depending on the indoor unit used, the operation display and airflow direction display settings will differ as shown below.
 - Use a pointed implement to change the switch position.
 - When the switch position has been changed, press the ACL button.
 - * For details on the flap functions, refer to the operating instructions of the indoor unit used.

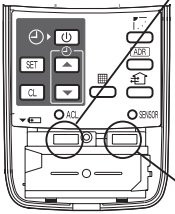

With the battery cover removed

	Model which supports different flap settings	Swing-only model	No-flap model
Slide switch position			
Flap display on wireless remote control unit			

	Heat pump (with auto cooling/heating function)	Heat pump (without auto cooling/heating function)	Cooling only
Operation mode display on wireless remote control unit			
Slide switch position			

- Before use, check that the slide switch has been set to the position shown in the figure above. For details on how to set the slide switch, consult your dealer.

- How to install batteries**
- Slide the cover in the direction indicated by the arrow and remove it.
 - Install two AAA alkaline batteries. Make sure the batteries point in the direction marked in the battery compartment.
 - Use a pointed implement to press the ACL button.

- The batteries last about a year, depending on how much you use the wireless remote control unit. Replace the batteries when the wireless remote control unit's display fails to light, or when the remote control cannot be used to change the air conditioner's settings.
- When the batteries are to be replaced, make sure that both batteries are new and that the same kind of battery is used.
- Remove the batteries if the wireless remote control unit is not going to be used for a prolonged period.
- Dispose of the used batteries at the designated location.

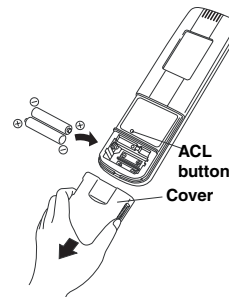

EG

Using the Wireless Remote Control Unit (continued)

How to use the wireless remote control unit

- Point the wireless remote control unit's transmitter at the signal receiver. If the signal is received properly, a beep is heard. (Two beeps are heard only when operation starts up.)
- Signals can be received over a distance of approximately 8 meters. This distance is approximate: it may be slightly more or less depending on how much charge remains in the batteries and on other factors.
- Ensure that the signals will not be blocked by any objects positioned between the transmitter and signal receiver.
- Avoid placing the wireless remote control unit where it will be exposed to direct sunlight or in the direct path of the air blown out from the air conditioner, near a heating appliance, etc.
- Do not drop, throw or wash the wireless remote control unit.
- Signal reception may not be accepted in rooms with fluorescent lights that use the electronic instantaneous lighting system (rapid start system) or inverter system. For further details, contact your dealer.

When mounting the wireless remote control unit on a wall for use

- Before mounting the wireless remote control unit on the wall, place the unit at the mounting position, press the ON/OFF operation button and check that the signals are received properly.
- To remove the wireless remote control unit, disengage it by pulling it toward you.

Secure the installation fitting of the wireless remote control unit using the screws.

Place here.

Procedure for installing the wireless remote control unit

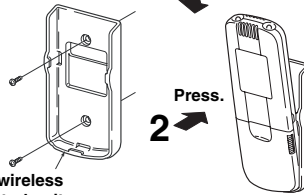

Installation fitting of wireless remote control unit

Operating tips

- **Do not operate the wireless remote control unit too far away from the signal receiver.**
Doing so may cause operational errors.
Make absolutely sure that the wireless remote control unit and signal receiver are both in the same room.
- **When operating the wireless remote control unit, point it directly at the signal receiver.**
A beep is heard when a signal is received properly.
- **Avoid places where the wireless remote control unit will be obscured by curtains, etc.**
Remove it before operation.

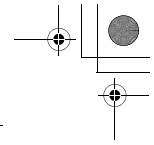
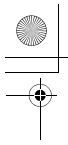

Address Settings

When a multiple number of indoor units that can be operated by the wireless remote control unit have been installed in the same room with a multi-unit or single-unit installation, the address button enables addresses to be set in order to prevent the sending of signals to the wrong indoor unit. Each of up to six indoor units can be controlled separately using its own wireless remote control unit by matching the number of the address switch on the operation area of the indoor unit and the number used for the address of its wireless remote control unit. (The indoor units cannot be controlled separately when they are used in a simultaneous operation of multi units format or any other such format since they will all operate at the same time.)

The signal receiver has an address switch for signal reception, and the wireless remote control unit has an address switch for signal transmission.

How to check the addresses When the ADDRESS button on the wireless remote control unit is pressed, the current address appears on the wireless remote control unit's display. The buzzer sounds if the address displayed matches the signal receiver's address. (The buzzer always sounds if "ALL" appears as the address display.)

If "ALL" appears as the address display, operations can be performed irrespective of the signal receiver's address. Point the wireless remote control unit at the signal receiver of the unit to be operated, and send the signal.

How to set the matching address

Wireless remote control unit's address setting

1. When the ADDRESS button is held down for 4 or more seconds, "ADR" lights on the wireless remote control unit's display, and the current address blinks.
2. Each time the ADDRESS button is now pressed, the address changes by one setting in the following sequence: ALL → 1 → 2 → 3 ... → 6 → ALL. Select the setting which matches the setting of the address switch in the operation area of the indoor unit to be operated.
3. When the SET button is now pressed, the address stops blinking and lights instead, and it remains on the display for 5 seconds. The buzzer sounds if the setting matches the setting of the address switch in the operation area of the indoor unit.

NOTE





When the batteries are replaced, the address setting returns to "ALL".

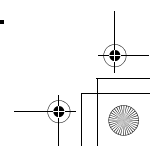
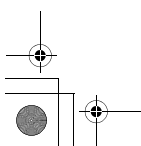

EG

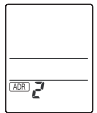

Address Settings (continued)

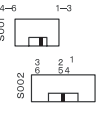
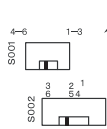
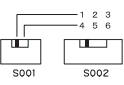
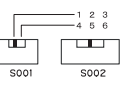
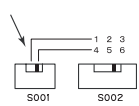
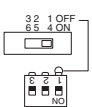
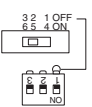
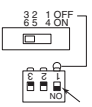
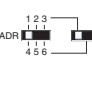
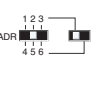
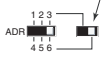
<p>Wireless remote control unit address displays</p> 				<p>.....</p>	
<p>CAFP type Position of address switch on signal receiver (inside indoor unit)</p>	<p>* The address switch in the operation area may be set to any position.</p>			<p>.....</p>	<p>For positions 1, 2 and 3, set the knob to the left; conversely, for 4, 5 and 6, set the knob to the right.</p> 
<p>SPAFP type Position of address switch on signal receiver (inside indoor unit)</p>	<p>* The address switch in the operation area may be set to any position.</p>			<p>.....</p>	<p>For positions 1, 2 and 3, set the knob to the left; conversely, for 4, 5 and 6, set the knob to the right.</p> 
<p>MAFP type Position of address switch inside indoor unit</p>	<p>* The address switch in the operation area may be set to any position.</p>			<p>.....</p>	<p>For positions 1, 2 and 3, set the knob upward (1); conversely, for 4, 5 and 6, set the knob downward (ON).</p> 
<p>DSAFP type Position of address switch in signal receiver</p>	<p>* The address switch in the operation area may be set to any position.</p>			<p>.....</p>	<p>For positions 1, 2 and 3, set the knob to the left; conversely, for 4, 5 and 6, set the knob to the right.</p> 

Emergency Operation

In any of the following events, use the Emergency operation button to operate the air conditioner on a makeshift basis.

- When there is no charge remaining in the wireless remote control unit's batteries
- When the wireless remote control unit has failed
- When the wireless remote control unit has been lost or misplaced

CAFP type Initiate operation using the Emergency operation button in the operation area of the indoor unit.

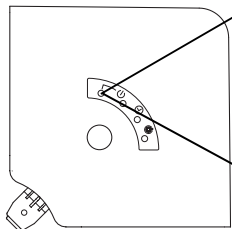

Operation
<p>Press the Emergency operation button. The air conditioner initiates a cooling operation when its operation is started up at a room temperature of 24°C or above. Conversely, it initiates a heating operation when its operation is started up at a room temperature below 24°C.</p>
Shutdown
<p>Press the Emergency operation button once more.</p>

SPAFP type Initiate operation using the Emergency operation button in the signal receiver on the indoor unit.

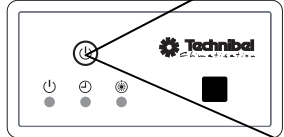

Operation
<p>Press the Emergency operation button. The air conditioner initiates a cooling operation when its operation is started up at a room temperature of 24°C or above. Conversely, it initiates a heating operation when its operation is started up at a room temperature below 24°C.</p>
Shutdown
<p>Press the Emergency operation button once more.</p>

EG

Emergency Operation (continued)

MAFP type Initiate operation using the Emergency operation button in the operation area of the indoor unit.

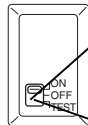

<p>Operation</p> <p>Set the ON/OFF operation switch to "OFF" first. Then set it to "ON." If a heat pump is used, the air conditioner initiates a cooling operation when its operation is started up at a room temperature of 24°C or above or it initiates a heating operation when its operation is started up at a room temperature below 24°C.</p>
<p>Shutdown</p> <p>Set the ON/OFF operation switch to "OFF."</p>

- NOTE**
- TEST is used to initiate a trial run when the air conditioner is first installed. It is not used under normal circumstances.
 - To restart the wireless remote control unit's operation, the ON/OFF operation switch must be set to ON without fail. If it is kept at the OFF setting, the signals from the wireless remote control unit will not be accepted.

DSAFP type Initiate operation using the Emergency operation button in the signal receiver.

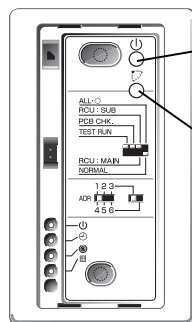































































<p>1. Press the Emergency operation button. The air conditioner initiates a cooling operation when its operation is started up at a room temperature of 24°C or above. Conversely, it initiates a heating operation when its operation is started up at a room temperature below 24°C.</p>
<p>2. When the SWING button is pressed, the air direction is automatically switched from upward to downward or vice versa.</p>
<p>Shutdown</p> <p>Press the Emergency operation button once more.</p>

Troubleshooting

Check out the following points before requesting service.

Trouble	Possible Cause	Remedy
Check again.	The air conditioner does not run even when the ON/OFF operation switch has been set to ON.	Is the air conditioner in the shutdown mode or was the switch operated after a power failure? Press the wireless remote control unit's ON/OFF operation button again.
		How about the local power switch? If it was off, set it now to on.
		Have any of the fuses blown? If a fuse has blown, contact your dealer.
		Is the ON timer operation mode established? Clear the timer operation.
		If the signal receiver's NORMAL/ALL OFF switch set to "ALL OFF"? If it is, set it to the "NORMAL" position and cancel the operation.
		Have the wireless remote control unit's batteries run down? If they have, replace them with new ones.
		Do the indication lamps show a cooling/heating mismatch or is the auto cooling/heating function not available? Change the operation mode.
Auto cooling/heating or heating appears on the display even though the air conditioner is a cooling-only model.		Change the setting of the wireless remote control unit's slide switch. (See page 11)

Trouble	Possible Cause																		
<p style="text-align: center;">(An indicator lamp is blinking.)</p> <table style="width: 100%; border-collapse: collapse;"> <tr> <td style="width: 33%; text-align: center;">Operation </td> <td style="width: 33%; text-align: center;">Timer </td> <td style="width: 33%; text-align: center;">Preparing for operation </td> </tr> <tr> <td style="text-align: center;">Operation </td> <td style="text-align: center;">Timer </td> <td style="text-align: center;">Preparing for operation </td> </tr> <tr> <td style="text-align: center;">Operation </td> <td style="text-align: center;">Timer </td> <td style="text-align: center;">Preparing for operation </td> </tr> <tr> <td style="text-align: center;">Operation </td> <td style="text-align: center;">Timer </td> <td style="text-align: center;">Preparing for operation </td> </tr> <tr> <td style="text-align: center;">Operation </td> <td style="text-align: center;">Timer </td> <td style="text-align: center;">Preparing for operation </td> </tr> <tr> <td style="text-align: center;">Operation </td> <td style="text-align: center;">Timer </td> <td style="text-align: center;">Preparing for operation </td> </tr> </table>	Operation 	Timer 	Preparing for operation 	Operation 	Timer 	Preparing for operation 	Operation 	Timer 	Preparing for operation 	Operation 	Timer 	Preparing for operation 	Operation 	Timer 	Preparing for operation 	Operation 	Timer 	Preparing for operation 	<ul style="list-style-type: none"> • Some kind of trouble has occurred in communication between the signal receiver and indoor unit. Alternatively, the wrong address has been set when a wired remote control unit is used. • Some kind of trouble has occurred in communication between the indoor unit and outdoor unit. • The indoor unit's protection device has been activated. Alternatively, the auto flap connector of the ceiling panel has been disconnected. • The outdoor unit's protection device has been activated. • Something is wrong with the temperature sensor. • The outdoor unit's compressor has been protected.
Operation 	Timer 	Preparing for operation 																	
Operation 	Timer 	Preparing for operation 																	
Operation 	Timer 	Preparing for operation 																	
Operation 	Timer 	Preparing for operation 																	
Operation 	Timer 	Preparing for operation 																	
Operation 	Timer 	Preparing for operation 																	
<table style="width: 100%; border-collapse: collapse;"> <tr> <td style="width: 33%; text-align: center;">Operation </td> <td style="width: 33%; text-align: center;">Timer </td> <td style="width: 33%; text-align: center;">Preparing for operation </td> </tr> </table>	Operation 	Timer 	Preparing for operation 	<ul style="list-style-type: none"> • A trial run is underway. Set the trial run switch to OFF. 															
Operation 	Timer 	Preparing for operation 																	

If the trouble persists even after performing the checks recommended above, shut down the air conditioner's operation, set the local power switch to OFF, and contact your dealer with the model number and trouble symptoms. You must NOT attempt to make repairs yourself due to the dangers involved. If one or more of the indication lamps is blinking, give this information to the dealer as well.

EG

Wired Remote Control Unit (Optional parts)





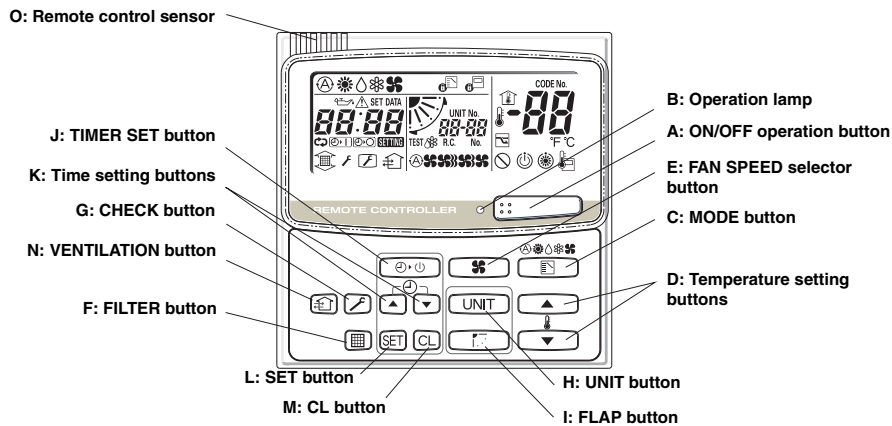





Parts Name and Functions

- This remote control unit can be used to operate up to eight indoor units. Once the operation settings are made, the units can be operated by simply pressing the ON/OFF operation button.
- In the DSAFP series, the flap position is not shown on the display.

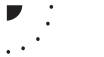

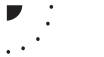

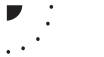



A: ON/OFF operation button	This button is for turning the air conditioner on and off.
B: Operation lamp	This lamp lights when the air conditioner is turned on. This lamp blinks when an error occurs or a protective device is activated.
C: MODE button	Use this button to select one of the following five operating modes. <div style="display: flex; justify-content: space-between;"> <div style="width: 45%;"> <p>(AUTO) ☼ : Used to automatically set cooling or heating operation. Only for single heat pump type (temperature range: 17 to 27°C)</p> <p>(HEAT) ☀ : Used for normal heating operation. Only for heat pump type (temperature range: 16 to 30°C)</p> <p>(DRY) ☹ : Used for dehumidifying without changing the room temperature. (temperature range: 18 to 30°C)</p> <p>(COOL) ☼ : Used for normal cooling operation. (temperature range: 18 to 30°C)</p> <p>(FAN) ☼ : Used to run the fan only, without heating or cooling operation.</p> </div> <div style="width: 45%; text-align: right;"> <p>☼ : Used to automatically set cooling or heating operation. Only for single heat pump type (temperature range: 17 to 27°C)</p> <p>☀ : Used for normal heating operation. Only for heat pump type (temperature range: 16 to 30°C)</p> <p>☹ : Used for dehumidifying without changing the room temperature. (temperature range: 18 to 30°C)</p> <p>☼ : Used for normal cooling operation. (temperature range: 18 to 30°C)</p> <p>☼ : Used to run the fan only, without heating or cooling operation.</p> </div> </div>
D: Temperature setting buttons	<p>▲ : Press this button to increase the temperature setting.</p> <p>▼ : Press this button to decrease the temperature setting.</p>
E: FAN SPEED selector button	<p>(AUTO) ☼ : The air conditioner automatically decides the fan speeds.</p> <p>(HI.) ☼ : High fan speed</p> <p>(MED.) ☼ : Medium fan speed</p> <p>(LO.) ☼ : Low fan speed</p>

Parts Name and Functions (continued)

F: FILTER button	This button is used to turn off the filter sign (). When the filter sign appears on the display, clean the filter, and then press this button to turn off the sign.																
G: CHECK button  CAUTION	This button is used only when servicing the air conditioner. Do not use the CHECK button for normal operation.																
H: UNIT button	When more than one indoor unit is connected, this button is used to select a unit when adjusting the airflow direction. If no unit is selected, the airflow direction of all units can be adjusted concurrently using the FLAP button.																
I: FLAP button  CAUTION NOTE (SWEEP)	<ol style="list-style-type: none"> Use this button to set the airflow direction to a specific angle. The airflow direction is displayed on the remote control unit. <table border="1" data-bbox="662 817 1204 952"> <thead> <tr> <th>Operation mode</th> <th>Number of airflow direction settings</th> </tr> </thead> <tbody> <tr> <td>⊗ (COOL) or △ (DRY)</td> <td>3</td> </tr> <tr> <td>⊗ (HEAT) or ⊗ (FAN)</td> <td>5</td> </tr> <tr> <td>⊕ (AUTO)</td> <td></td> </tr> <tr> <td> Cooling mode:</td> <td>3</td> </tr> <tr> <td> Heating mode:</td> <td>5</td> </tr> </tbody> </table> <ul style="list-style-type: none"> In the cool mode and dry mode, if the flaps are set in a downward position, condensation may form and drip around the vent. Do not move the flap with your hands. This function is available for models CAFP, SPAFP and MAFP. Use this button to make the airflow direction sweep up and down automatically. Press this button several times until the  symbol appears on the display. <p>To stop the swing operation Press the FLAP button again during the flap swing operation to stop the flap at the desired position. Then, the airflow can be set from the top position by pressing the FLAP button again.</p> <p>Indicator when swing operation is stopped</p> <table border="1" data-bbox="635 1350 1090 1458"> <thead> <tr> <th>Fan and heating</th> <th>Cooling and drying</th> </tr> </thead> <tbody> <tr> <td></td> <td></td> </tr> </tbody> </table> <p>During cooling and drying, the flap does not stop at the downward position. Even if the flap is stopped at the downward position during the swing operation, it does not stop until it moves to the third position from the top.</p> <p>NOTE This function is available for models CAFP, SPAFP and MAFP.</p>	Operation mode	Number of airflow direction settings	⊗ (COOL) or △ (DRY)	3	⊗ (HEAT) or ⊗ (FAN)	5	⊕ (AUTO)		Cooling mode:	3	Heating mode:	5	Fan and heating	Cooling and drying		
Operation mode	Number of airflow direction settings																
⊗ (COOL) or △ (DRY)	3																
⊗ (HEAT) or ⊗ (FAN)	5																
⊕ (AUTO)																	
Cooling mode:	3																
Heating mode:	5																
Fan and heating	Cooling and drying																
																	

EG

Parts Name and Functions (continued)

J: TIMER SET button (OFF Timer) (OFF Cycle Timer) (ON Timer)	Use this button while the unit is operating to switch between timer settings.  : The air conditioner stops after a preset time elapses.  : The air conditioner always stops after a preset time elapses.  : The air conditioner starts after a preset time elapses.	
K: Time setting buttons	 : Press this button to increase the time.  : Press this button to decrease the time.	
L: SET button	Use this button to set the timer.	
M: CL button	Use this button to clear the timer setting.	
N: VENTILATION button	This is used when a ventilation fan (available commercially) is connected. Pressing the VENTILATION button turns the fan on and off. The ventilation fan also turns on and off when the air conditioner unit is turned on and off. (The display of the remote control unit shows “  O: Remote control sensor	Normally, the temperature sensor of the indoor unit is used to detect the temperature. However, it is also possible to detect the temperature around the remote control unit. For details, contact the dealer where you made the purchase. (Do not set when using group control.)

NOTE

- 1) When two remote control units are being used in one group control* system,
 - a) the most recent button that is pressed on any remote control unit is effective.
 - b) either a main-remote control unit or a sub-remote control can set the timer.
 - * Group control means that maximum up to 8 indoor units can be concurrently controlled with a remote control unit.
- 2) If a power failure occurs in timer mode, the time counted up to that point will be stored in memory.
 After power is restored, the timer starts again counting up to the set time.

Display

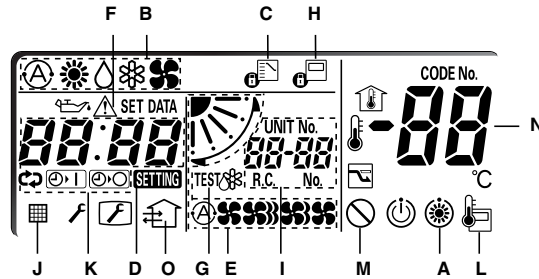

Description

- A:** When the unit is in the heating standby mode, the indicator appears. While this indicator is displayed, the indoor fan turns off or on at low fan speed.
- B:** The currently selected operation mode is displayed.
- C:** This is displayed if a different operation mode was selected already by another remote control unit and indicates that the mode cannot be changed.
- D:** After turning on the mains power switch for the first time, **SETTING** indicator blinks on the display of the remote control unit. While this is displayed, the system is automatically checking units, and so wait until the **SETTING** indicator turns off to operate the remote control unit. When the **TIMER SET** button is pressed to set the timer, the **SETTING** indicator flashes.
- E:** The currently selected **FAN SPEED**, fan angle and **SWEEP** status are displayed.
- F:** This is displayed only if an abnormality occurs within a unit.
- G:** When the **CHECK** button is pressed for more than 4 seconds, the **TEST** indicator appears. Then, press the **ON/OFF** operation button to start test run.
- H:** This is displayed to indicate that the system controller is being used for control. When is flashing on the display, the operation is not accepted by the system controller.
- I:** This displays the unit number of the indoor unit selected with the unit selection button or the indoor/outdoor unit where an error is indicated.

Unit No.

1 — 2

Indoor unit No.

Refrigerant circuit No.

- J:** This is displayed if it is time to clean the filter.
- K:** When setting the timer, the selected timer mode is displayed. This displays the time of the timer. (An alarm message is displayed when an error occurs.) Pressing the **TIMER SET** button cycles through the options in this order: → → → No Display
- L:** This is displayed when using the remote control unit sensor.
- M:** This is displayed if a function is unavailable when a button is pressed.
- N:** This displays the temperature setting.
- O:** This is displayed when a connected ventilation fan (available commercially) is operating.

EG

Operation

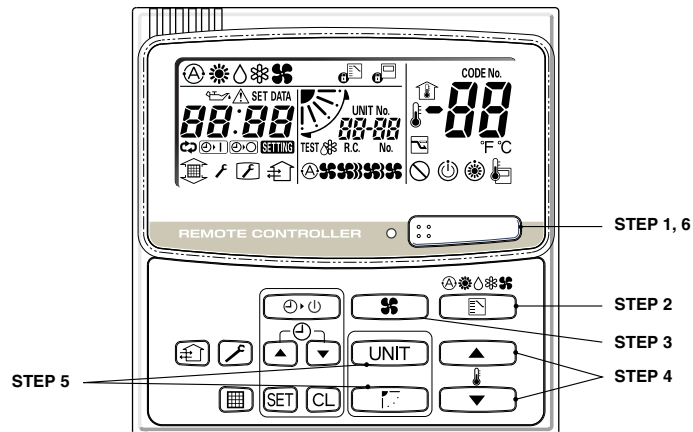

- NOTE**
- To warm up the system, the power mains must be turned on at least five (5) hours before operation.

- STEP 1 To start the air conditioner**
Press the operation button (ON/OFF button).
- STEP 2 Setting the mode**
Press the MODE button to select the mode of your choice.
[(AUTO), * (HEAT), ∪ (DRY), * (COOL) or * (FAN)]
- STEP 3 Setting the fan speed**
Press the FAN SPEED selector button to select the fan speed of your choice.
[(AUTO), * (HI.), * (MED.) or * (LO.)]
- If AUTO is selected, the fan speed switches automatically.
- STEP 4 Setting the temperature**
Use the ∇ or ▲ button as appropriate to change the temperature setting as desired.
(∇ reduces the temperature, and ▲ increases the temperature.)
* The temperature cannot be set during FAN mode operation.
- STEP 5 Setting the airflow direction**
When more than one indoor unit is connected, the UNIT button is used first to select a unit. Then use the FLAP button to set the airflow direction to a specific angle or to sweep.
- STEP 6 To stop the air conditioner**
Press the operation button (ON/OFF button) again.

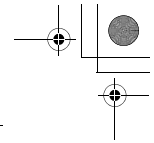

Operation (continued)

Automatic heating and cooling (Only for heat pump type)

The air conditioner automatically performs heating and cooling operation based on the difference between the temperature setting and room temperature. All indoor units in the same refrigerant system can be operated with a single group control.

Simultaneous operation of multiple units (Group control)

Group control is suitable for air conditioning of a large room using multiple air conditioning units.

- One remote control unit can control up to four indoor units.
- All indoor units have the same settings except for the airflow direction.
- The temperature sensors at the indoor unit side are used.

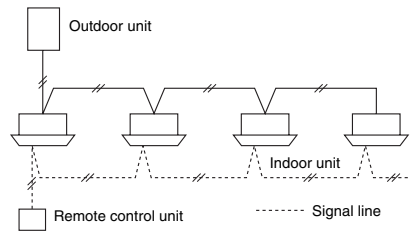

EG

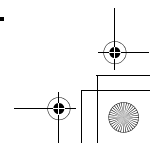



Adjusting the Airflow Direction



The functions differ depending on the indoor unit used. The airflow direction cannot be set using the remote control unit for any unit which is not listed below.

4-way type (CAFP), ceiling mounted type (SPAFP) and wall mounted type (MAFP).

- Never use your hands to move the flap (vertical airflow flap) that is controlled using the remote control unit.
- When the air conditioner is turned off, the flap (vertical airflow flap) automatically moves to the downward position.
- The flap (vertical airflow flap) moves to the upward position when performing the standby operation for heating. The swing operation is made after the standby operation for heating is released, but swing is indicated on the remote control unit even during the standby operation for heating.

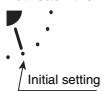
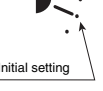

Setting the airflow direction The airflow direction changes each time the  FLAP button is pressed during operation.

To activate the swing operation Press the FLAP button to set the flap (vertical airflow flap) to the downward position, and then press the FLAP button again. This displays , and the airflow automatically swings up and down.

Heating	Cooling and drying	Fan operation	All operations
<p>Set the flap (vertical airflow flap) to the downward position. If the flap is set to the upward position, the warm air may not reach the floor.</p> 	<p>The flap (vertical airflow flap) can be set to one of three positions.</p> 		

To stop the swing operation Press the FLAP button again during the flap swing operation to stop the flap at the desired position. Then, the airflow can be set from the top position by pressing the FLAP button again.

Indicator when swing operation is stopped

Fan and heating	Cooling and drying
	

During cooling or drying operation, the flap will not stop at the downward position. Even if the flap is stopped at the downward position during the swing operation, it will not stop until it moves to the third position from the top.

Adjusting the Airflow Direction (continued)

■ Semi-concealed type 4-way type (CAFP)

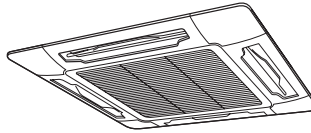

This air conditioner is equipped with auto flaps. You can set the airflow direction to a specific angle or to the sweep mode using the remote control unit.



CAUTION

Do not move the flap with your hands.

- The air outlet flap can be easily removed and washed with water.
- Be sure to always stop operation before removing the flap.
- After washing with water, allow it to dry, and then remount it with the arrow facing outward.

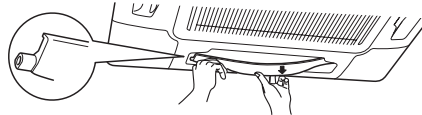

■ Ceiling mounted type (SPAFP)

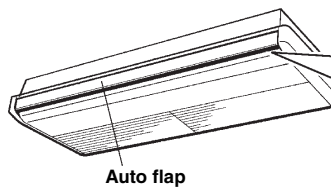

Auto flap

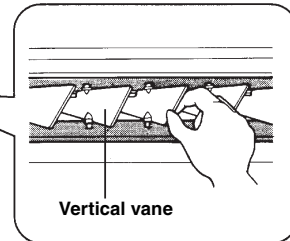

Vertical vane

EG

A. Vertical directions (automatic)

This air conditioner is equipped with an auto flap. You can set the airflow direction to a specific angle or to the sweep mode using the remote control unit. (Refer to the description of the remote control unit.)



CAUTION

Do not move the flap with your hands.

B. Horizontal directions (manual)

The horizontal airflow direction can be adjusted manually by moving the vertical vanes to the left or right.

Adjusting the Airflow Direction (continued)

■ Wall mounted type (MAFP)

A. Vertical directions (automatic)

Confirm that the remote control unit has been turned on. Press the FLAP button to start the flap moving up and down. If you want to stop the flap movement and to direct the air in the desired direction, press the FLAP button again. In the cool mode, don't direct the flap down more than 30°, otherwise, condensation may drip on to the floor. Zone "A" is the recommended flap position for cooling.



CAUTION

Do not move the flap with your hands.

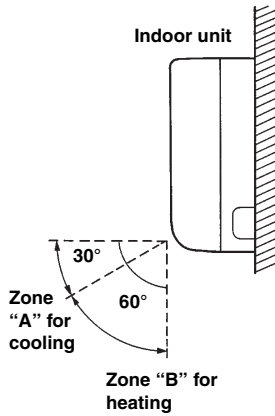

B. Horizontal directions (manual)

The horizontal airflow direction can be adjusted manually by moving the vertical vanes to the left or right.

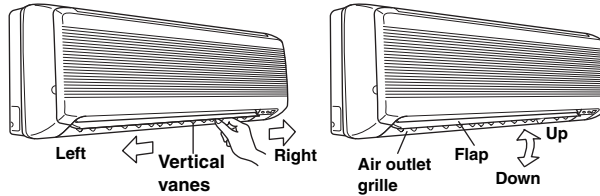

■ Concealed duct type (DSAFP)

This air conditioner is not equipped with air outlet parts. These must be obtained locally. Please refer to the manual of the locally adopted air outlet parts.

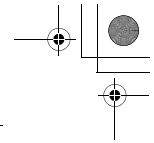

Adjusting the Airflow Direction for Multiple Indoor Units Using a Single Remote Control Unit

- The airflow direction cannot be set using the remote control unit for the concealed duct type (DSAFP).
- If multiple indoor units are connected to a remote control unit, the airflow direction can be set for each indoor unit by selecting the indoor units (see the operation below).

Auto Flap () button

- To set the airflow for individual units, press the UNIT button. Display shows the indoor unit number under group control. Set the airflow direction for the indoor unit that is shown on the display.
- Each time UNIT is pressed, the indicator changes in the order shown below.
- When nothing is displayed, you can make the setting for all indoor units in one operation.
- The unit number is displayed as Outdoor Unit Number–Indoor Unit Number. It varies depending on the number of units under group control.

One outdoor unit and four indoor units

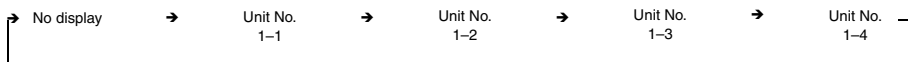

Two outdoor units and four indoor units

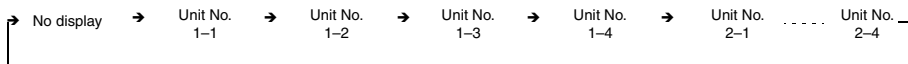

EG

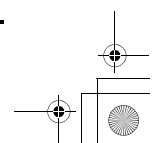

Special Remarks

“DRY” Operation

- How it works**
- Once the room temperature reaches the level that was set, the unit repeats the cycle of turning on and off automatically.
 - In order to prevent the humidity in the room from rising again, the indoor fan also turns off when the unit stops operating.
 - The fan speed is set to “LO.” automatically, and cannot be adjusted.
 - “DRY” operation is not possible if the outdoor temperature is 15 °C or less.

Heating Operation

- Heating performance**
- Because this appliance heats a room by utilizing the heat of the outside air (heat pump system), the heating efficiency will fall off when the outdoor temperature is very low. If sufficient heat cannot be obtained with this heat pump, use another heating appliance in conjunction with this unit.

- Defrosting**
- When the outdoor temperature is low, frost or ice may form on the outdoor heat exchanger coil, reducing the heating performance. When this happens, a microcomputer-controlled defrosting system operates. At the same time, the fan on the indoor unit stops (or runs at very low speed in some cases) and the “STANDBY” indicator appears on the display until defrosting is completed. Heating operation then restarts after several minutes. (This interval will vary slightly depending upon the outdoor temperature and the way in which frost forms.)



- ☼ (standby) on the display**
- For several minutes after the start of heating operation, the indoor fan will not start running (or it will run at very low speed in some cases) until the indoor heat exchanger coil has warmed up sufficiently. This is because a cold draft prevention system is operating. During this period, the “☼” (standby) indicator remains displayed.
 - “☼” (standby) remains displayed during defrosting or when the compressor has been turned off (or when the unit is running at very low speed) by the thermostat when the system is in the heating mode.
 - Upon completion of defrosting and when the compressor is turned on again, “☼” (standby) will turn off automatically as heating operation resumes.



NOTE Should the power fail while the unit is running

If the power supply for this unit is temporarily cut off, the unit will automatically resume operation (once the power is restored) using the same settings before the power was cut off.

Setting the Timer

Using the timer • Set the timer during air conditioner operation.

Recommended usage	Display
To stop the air conditioner after a preset time elapses	OFF timer 
To always stop the air conditioner after a preset time elapses	OFF cycle timer 
To start the air conditioner after a preset time elapses	ON timer 

Time indicator of timer Each time  is pressed, the time setting increases at 0.5-hour (30 minute) intervals. The upper limit is 72.0 hours. Each time  is pressed, the time setting decreases at 0.5-hour (30 minute) intervals. The lower limit is 0.5 hours.

Timer indicator The timer cycles through the following options each time  (TIMER SET button) is pressed.



 **OFF timer**

Use this mode to turn off the unit automatically after a preset time elapses.

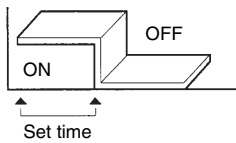

 **OFF cycle timer**

Use this mode to always turn off the unit automatically after a preset time elapses.

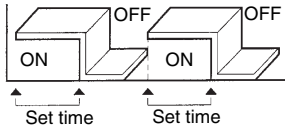

 **ON timer**

Use this mode to start the unit automatically after a preset time elapses.

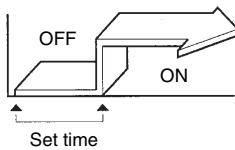

NOTE When two remote control units are being used, either a main-remote control unit or a sub-remote control unit can be used for timer operations.

EG

Setting the Timer (continued)

How to set the OFF timer (⏸)



Example: Stopping the air conditioner after 3.5 hours of operation

- | Operation | Indication |
|--|---|
| 1. Press the ON/OFF button once to start the air conditioner. | |
| 2. Press the TIMER SET button to select the ⏸ mode. ➡ | The SETTING and time indications (hour) flash. |
| 3. <ul style="list-style-type: none"> • Press the ▲ button until 3.5 is displayed. • Press the ▼ button if the set time is exceeded. | |
| 4. Press the SET button to set the OFF timer. | |

How to set the OFF cycle timer (⏸⏸)



Example: Always stopping the air conditioner after 3.5 hours of operation

- | Operation | Indication |
|---|------------|
| 1. Press the ON/OFF button to start the air conditioner. | |
| 2. Press the TIMER SET button twice to select the ⏸⏸ mode. | |
| 3. Set the time using the ▲ or ▼ button. | |
| 4. Press the SET button to set the OFF cycle timer (⏸⏸). | |

NOTE When the OFF cycle timer is set, the unit will always stop after 3.5 hours of operation.

How to set the ON timer (⏸|)



Example: Starting the air conditioner 10.5 hours after the ON time setting

- | Operation | Indication |
|---|---|
| 1. Press the ON/OFF button to start the air conditioner. | |
| 2. Press the TIMER SET button to select the ⏸ mode. ➡ | The SETTING and time indications (hour) flash. |
| 3. <ul style="list-style-type: none"> • Press the ▲ button until 10.5 is displayed. • Press the ▼ button if the set time is exceeded. | |
| 4. Press the SET button to set the ON timer. | |

NOTE When the ON timer is set, the unit enters the paused state.

Canceling timer operation

Press the CL button to cancel operation. The time setting is canceled, and the timer indicator no longer appears on the display.

Care and Cleaning



WARNING

1. For safety, be sure to turn the air conditioner off and also to disconnect the power before cleaning.
2. Do not pour water on the indoor unit to clean it. This will damage the internal components and cause an electric shock hazard.

Air intake and outlet side (Indoor unit)

Clean the air intake and outlet side of the indoor unit with a vacuum cleaner brush, or wipe them with a clean, soft cloth.

If these parts are stained, use a clean cloth moistened with a mild liquid detergent. When cleaning the air outlet side, be careful not to force the vanes out of place.



CAUTION

1. Never use solvents or harsh chemicals when cleaning the indoor unit. Do not wipe plastic parts using very hot water.
2. Some metal edges and the fins are sharp and may cause injury if handled improperly; be especially careful when you clean these parts.
3. The internal coil and other components of the outdoor unit must be cleaned every year. Consult your dealer or service center.

Air filter

The air filter collects dust and other particles from the air and should be cleaned at regular intervals as indicated in the table below or when the filter indication (■) on the display of the remote control unit (wired type) shows that the filter needs cleaning. If the filter gets blocked, the efficiency of the air conditioner drops greatly.

Type	CAFP	SPAFP	MAFP	DSAFP*
Period	Six months	Two weeks	Two weeks	(depending on filter specifications)

*Concealed duct type (DSAFP):

An air filter is not provided with this air conditioner at the time of shipment. To get clean air and to extend the service life of the air conditioner, an air filter must be installed in the air intake. For installation and cleaning the air filter, consult your dealer or service center.

NOTE

The frequency with which the filter should be cleaned depends on the environment in which the unit is used.

How to clean the filter

1. Remove the air filter from the air intake grille.
2. Use a vacuum cleaner to remove light dust. If there is sticky dust on the filter, wash the filter in lukewarm, soapy water, rinse it in clean water, and dry it.

EG

Care and Cleaning (continued)

How to remove the filter

4-way semi-concealed type (CAFP):

1. Use a screwdriver to remove the bolt screw on each side for the two latches. (Be sure to reattach the two bolt screws after cleaning.)
2. Press on the two latches of the air intake grille with your thumbs in the direction of the arrow to open the grille.
3. Open the air intake grille downward.



CAUTION

- When cleaning the air filter, never remove the safety chain. If it is necessary to remove it for servicing and maintenance inside, be sure to reinstall the safety chain securely (hook on the grille side) after the work.
- When the filter has been removed, rotating parts (such as the fan), electrically charged areas, etc. will be exposed in the unit's opening. Bear in mind the dangers that these parts and areas pose, and proceed with the work carefully.

4. Remove the air filter attached to the air intake grille.

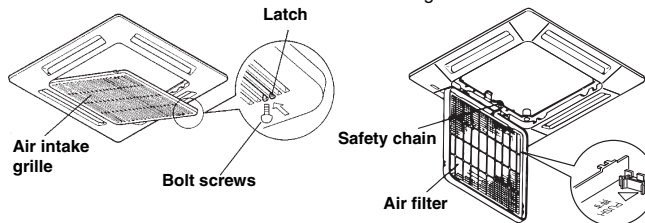

Ceiling-mounted type (SPAFP):

1. Take hold of the finger-hold on the air intake grille and press it to the rear, and the grille will open downward.
2. Take hold of the finger-hold on the air filter, pull it toward you.

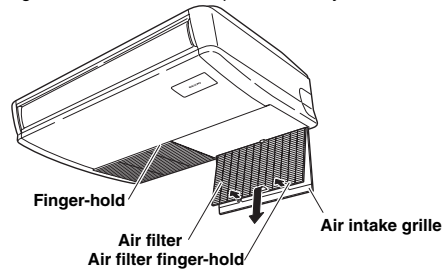

Wall-mounted type (MAFP):

1. Move the flap on the air outlet grille to its lowest position with the remote control unit.
2. The filter is disengaged by pushing the tab up gently. Hold the air filter by the tab at the bottom, and pull downward.

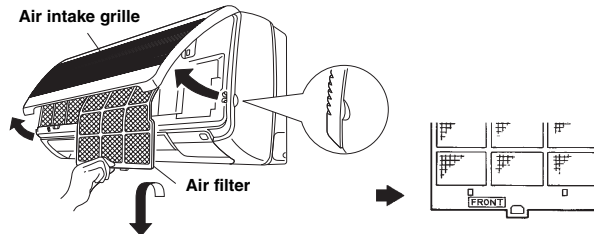

When replacing the filter, make sure that the FRONT mark is facing you. Push it up until you hear it click back into position.

Troubleshooting

If your air conditioner does not work properly, first check the following points before requesting service. If it still does not work properly, contact your dealer or a service center.

Trouble	Possible Cause	Remedy
Air conditioner does not run at all.	<ol style="list-style-type: none"> 1. Power failure. 2. Leakage circuit breaker has tripped. 3. Line voltage is too low. 4. Operation button is turned off. 5. The wired remote control unit or heat pump is malfunctioning. (The inspection mark  and the letters E, F, H, L, P in combination with numbers appear on the LCD of the wired remote control unit.) 	<ol style="list-style-type: none"> 1. After a power outage, press ON/OFF operation button on the wired remote control unit. 2. Contact service center. 3. Consult your electrician or dealer. 4. Press the button again. 5. Consult your dealer.
Compressor runs but soon stops.	<ol style="list-style-type: none"> 1. Obstruction in front of condenser coil. 	<ol style="list-style-type: none"> 1. Remove obstruction.
Poor cooling (or heating) performance.	<ol style="list-style-type: none"> 1. Dirty or clogged air filter. 2. Heat source or many people in room. 3. Doors and/or windows are open. 4. Obstacle near air intake or air discharge port. 5. Thermostat is set too high for cooling (or too low for heating). 6. (Defrosting system does not work.) 	<ol style="list-style-type: none"> 1. Clean air filter to improve the airflow. 2. Eliminate heat source if possible. 3. Shut them to keep the heat (or cold) out. 4. Remove it to ensure good airflow. 5. Set the temperature lower (or higher). 6. (Consult your dealer.)

Tips for Energy Saving

- Avoid**
- Do not block the air intake and outlet of the unit. If either is obstructed, the unit will not work well, and may be damaged.
 - Do not let direct sunlight into the room. Use sunshades, blinds or curtains. If the walls and ceiling of the room are warmed by the sun, it will take longer to cool the room.
- Do**
- Always try to keep the air filter clean. (Refer to "Care and Cleaning".) A clogged filter will impair the performance of the unit.
 - To prevent conditioned air from escaping, keep windows, doors and any other openings closed.

NOTE Should the power fail while the unit is running

If the power supply for this unit is temporarily cut off, the unit will automatically resume operation once power is restored using the same settings before the power was cut off.

EG

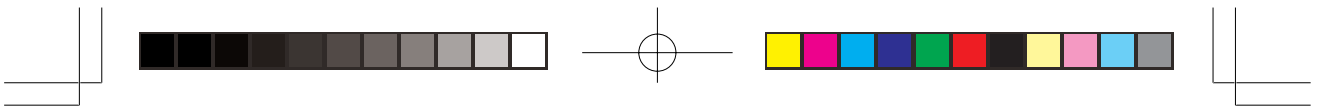

R.D. 28 Reyrieux BP 131-01601 Trévoux CEDEX France
Tél. 04.74.00.92.92 - Fax 04.74.00.42.00
R.C.S. Bourg-en-Bresse B 759 200 728

