

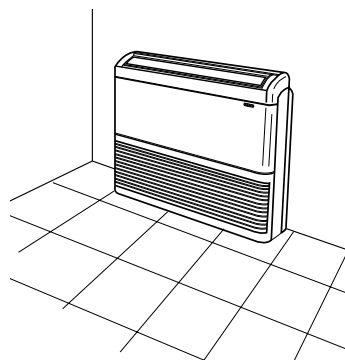

INSTALLATION MANUAL

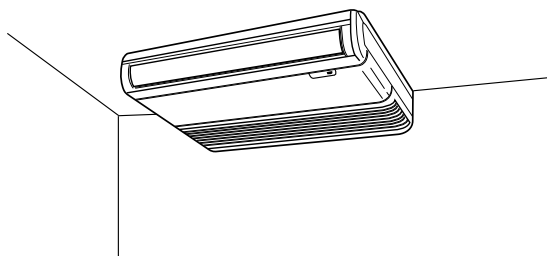

**KPAFP125R5IA-
KPAFP165R5IA-
KPAFP185R5IA-**

Split system air conditioner

37.4163.267.0

MARZO 2005

IMPORTANT! Please Read Before Starting

This air conditioning system meets strict safety and operating standards. As the installer or service person, it is an important part of your job to install or service the system so it operates safely and efficiently.

For safe installation and trouble-free operation, you must:

- Carefully read this instruction booklet before beginning.
- Follow each installation or repair step exactly as shown.
- Observe all local, state, and national electrical codes.
- This product is intended for professional use. Permission from the power supplier is required when installing an outdoor unit that is connected to a 16 A distribution network.
- Pay close attention to all warning and caution notices given in this manual.



WARNING

This symbol refers to a hazard or unsafe practice which can result in severe personal injury or death.



CAUTION

This symbol refers to a hazard or unsafe practice which can result in personal injury or product or property damage.

If Necessary, Get Help

These instructions are all you need for most installation sites and maintenance conditions. If you require help for a special problem, contact our sales/service outlet or your certified dealer for additional instructions.

In Case of Improper Installation

The manufacturer shall in no way be responsible for improper installation or maintenance service, including failure to follow the instructions in this document.

SPECIAL PRECAUTIONS

WARNING When Wiring



ELECTRICAL SHOCK CAN CAUSE SEVERE PERSONAL INJURY OR DEATH. ONLY A QUALIFIED, EXPERIENCED ELECTRICIAN SHOULD ATTEMPT TO WIRE THIS SYSTEM.

- Do not supply power to the unit until all wiring and tubing are completed or reconnected and checked.
- Highly dangerous electrical voltages are used in this system. Carefully refer to the wiring diagram and these instructions when wiring. Improper connections and inadequate grounding can cause **accidental injury or death**.
- **Ground the unit** following local electrical codes.
- Connect all wiring tightly. Loose wiring may cause overheating at connection points and a possible fire hazard.

When Transporting

Be careful when picking up and moving the indoor and outdoor units. Get a partner to help, and bend your knees when lifting to reduce strain on your back. Sharp edges or thin aluminum fins on the air conditioner can cut your fingers.

When Installing...

...In a Room

Properly insulate any tubing run inside a room to prevent "sweating" that can cause dripping and water damage to walls and floors.

...In Moist or Uneven Locations

Use a raised concrete pad or concrete blocks to provide a solid, level foundation for the outdoor unit. This prevents water damage and abnormal vibration.

...In an area with High Winds

Securely anchor the outdoor unit down with bolts and a metal frame. Provide a suitable air baffle.

...In a Snowy Area (for Heat Pump-type Systems)

Install the outdoor unit on a raised platform that is higher than drifting snow. Provide snow vents.

When Connecting Refrigerant Tubing

- Ventilate the room well, in the event that is refrigerant gas leaks during the installation. Be careful not to allow contact of the refrigerant gas with a flame as this will cause the generation of poisonous gas.
- Keep all tubing runs as short as possible.
- Use the flare method for connecting tubing.
- Apply refrigerant lubricant to the matching surfaces of the flare and union tubes before connecting them, then tighten the nut with a torque wrench for a leak-free connection.
- Check carefully for leaks before starting the test run.

NOTE

Depending on the system type, liquid and gas lines may be either narrow or wide. Therefore, to avoid confusion the refrigerant tubing for your particular model is specified as either "narrow" or "wide" than as "liquid" or "gas."

When Servicing

- Turn the power OFF at the main power box (mains) before opening the unit to check or repair electrical parts and wiring.
- Keep your fingers and clothing away from any moving parts.
- Clean up the site after you finish, remembering to check that no metal scraps or bits of wiring have been left inside the unit being serviced.



CAUTION

- Ventilate any enclosed areas when installing or testing the refrigeration system. Escaped refrigerant gas, on contact with fire or heat, can produce dangerously toxic gas.
- Confirm after installation that no refrigerant gas is leaking. If the gas comes in contact with a burning stove, gas water heater, electric room heater or other heat source, it can cause the generation of poisonous gas.

Check of Density Limit

The room in which the air conditioner is to be installed requires a design that in the event of refrigerant gas leaking out, its density will not exceed a set limit.

The refrigerant (R410A), which is used in the air conditioner, is safe, without the toxicity or combustibility of ammonia, and is not restricted by laws imposed to protect the ozone layer. However, since it contains more than air, it poses the risk of suffocation if its density should rise excessively. Suffocation from leakage of refrigerant is almost non-existent. With the recent increase in the number of high density buildings, however, the installation of multi air conditioner systems is on the increase because of the need for effective use of floor space, individual control, energy conservation by curtailing heat and carrying power, etc.

Most importantly, the multi air conditioner system is able to replenish a large amount of refrigerant compared to conventional individual air conditioners. If a single unit of the multi air conditioner system is to be installed in a small room, select a suitable model and installation procedure so that if the refrigerant accidentally leaks out, its density does not reach the limit (and in the event of an emergency, measures can be made before injury can occur).

In a room where the density may exceed the limit, create an opening with adjacent rooms, or install mechanical ventilation combined with a gas leak detection device. The density is as given below.

Total amount of refrigerant (kg)

$$\text{Min. volume of the indoor unit installed room (m}^3\text{)} \leq \text{Density limit (kg/m}^3\text{)}$$

The density limit of refrigerant which is used in multi air conditioners is 0.3 kg/m^3 (ISO 5149).

NOTE

1. If there are 2 or more refrigerating systems in a single refrigerating device, the amount of refrigerant should be as charged in each independent device.

For the amount of charge in this example:

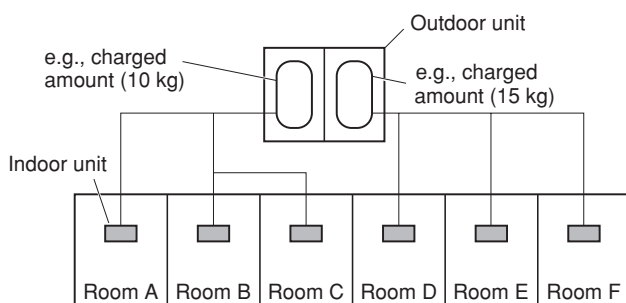

The possible amount of leaked refrigerant gas in rooms A, B and C is 10 kg.

The possible amount of leaked refrigerant gas in rooms D, E and F is 15 kg.

2. The standards for minimum room volume are as follows.

- (1) No partition (shaded portion)

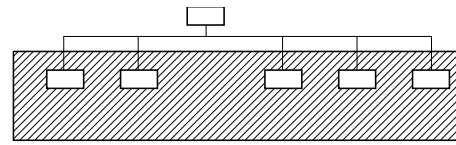

- (2) When there is an effective opening with the adjacent room for ventilation of leaking refrigerant gas (opening without a door, or an opening 0.15% or larger than the respective floor spaces at the top or bottom of the door).

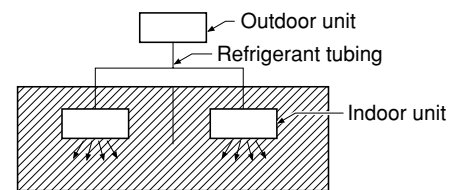

- (3) If an indoor unit is installed in each partitioned room and the refrigerant tubing is interconnected, the smallest room of course becomes the object. But when mechanical ventilation is installed interlocked with a gas leakage detector in the smallest room where the density limit is exceeded, the volume of the next smallest room becomes the object.

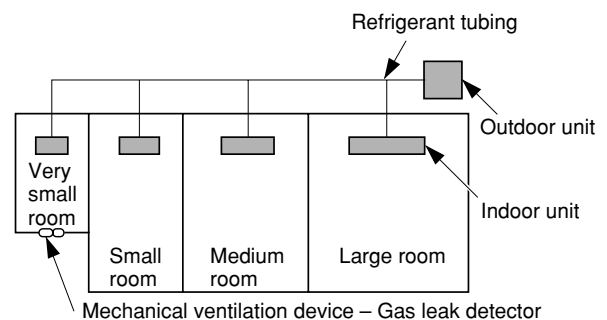

3. The minimum indoor floor space compared with the amount of refrigerant is roughly as follows: (When the ceiling is 2.7 m high)

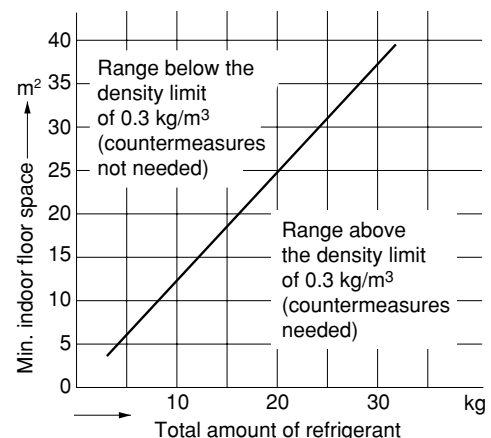

CONTENTS

	Page		Page
IMPORTANT	2	4-2. Recommended Wire Length and Wire Diameter for Power Supply System	
Please Read Before Starting		4-3. Wiring System Diagrams	
Check of Density Limit		5. HOW TO PROCESS TUBING	12
1. GENERAL	4	5-1. Connecting the Refrigerant Tubing	
1-1. Tools Required for Installation (not supplied)		5-2. Connecting Tubing between Indoor and Outdoor Units	
1-2. Accessories supplied with the unit		5-3. Insulating the Refrigerant Tubing	
1-3. Type of Copper Tube and Insulation Material		5-4. Taping the Tubes	
1-4. Additional Materials Required for Installation		5-5. Finishing the Installation	
2. DIMENSIONS	5	6. SPECIAL REMARKS	16
3. HOW TO INSTALL THE UNIT	6	■ HOW TO INSTALL THE WIRELESS REMOTE CONTROLLER RECEIVER K70D038ZAA ...	16
3-1. Suspending the Unit at the Ceiling		6-1. Installing the Control Unit	
3-2. Installation of the Condensate Drain Pipe		6-2. Accessories	
3-3. Duct for fresh air		7. APPENDIX	17
4. ELECTRICAL WIRING	8		
4-1. General Precautions on Wiring			









1. GENERAL

This booklet briefly outlines where and how to install the air conditioning system. Please read over the entire set of instructions for the indoor unit and make sure all accessory parts listed are with the system before beginning.

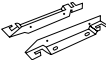
1-1. Tools Required for Installation (not supplied)

- | | |
|---|--|
| <ol style="list-style-type: none"> 1. Standard screwdriver 2. Phillips head screwdriver 3. Knife or wire stripper 4. Tape measure 5. Carpenter's level 6. Sabre saw or key hole saw 7. Hacksaw | <ol style="list-style-type: none"> 8. Core bits 9. Hammer 10. Drill 11. Tube cutter 12. Tube flaring tool 13. Torque wrench 14. Adjustable wrench 15. Reamer (for deburring) |
|---|--|

1-2. Accessories supplied with the unit

PARTS	FIGURE	Q.TY	PARTS	FIGURE	Q.TY	PARTS	FIGURE	Q.TY
RAWL PLUG		2	BOLT M8		4	BRACKET		1
BRACKET		2	TAPPING SCREW 4x30		2	SIDE PANELS (LEFT AND RIGHT)		2
WASHER SPRING WASHER		4	FULL SCALL DIAGRAM		1	TAPPING SCREW 4,2x9,5		4

1-3. Type of Copper Tube and Insulation Material

If you wish to purchase these materials separately from a local source, you will need:

1. Deoxidized annealed copper tube for refrigerant tubing.
2. Foamed polyethylene insulation for copper tubes as required to precise length of tubing. Wall thickness of the insulation should be not less than 8 mm.
3. Use insulated copper wire for field wiring. Wire size varies with the total length of wiring. Refer to **4. Electrical Wiring** for details.



CAUTION

Check local electrical codes and regulations before obtaining wire. Also, check any specified instructions or limitations.

1-4. Additional Materials Required for Installation

1. Refrigeration (armored) tape
2. Insulated staples or clamps for connecting wire (See your local codes.)
3. Putty
4. Refrigeration tubing lubricant
5. Clamps or saddles to secure refrigerant tubing
6. Scale for weighing

2. DIMENSIONS (mm)

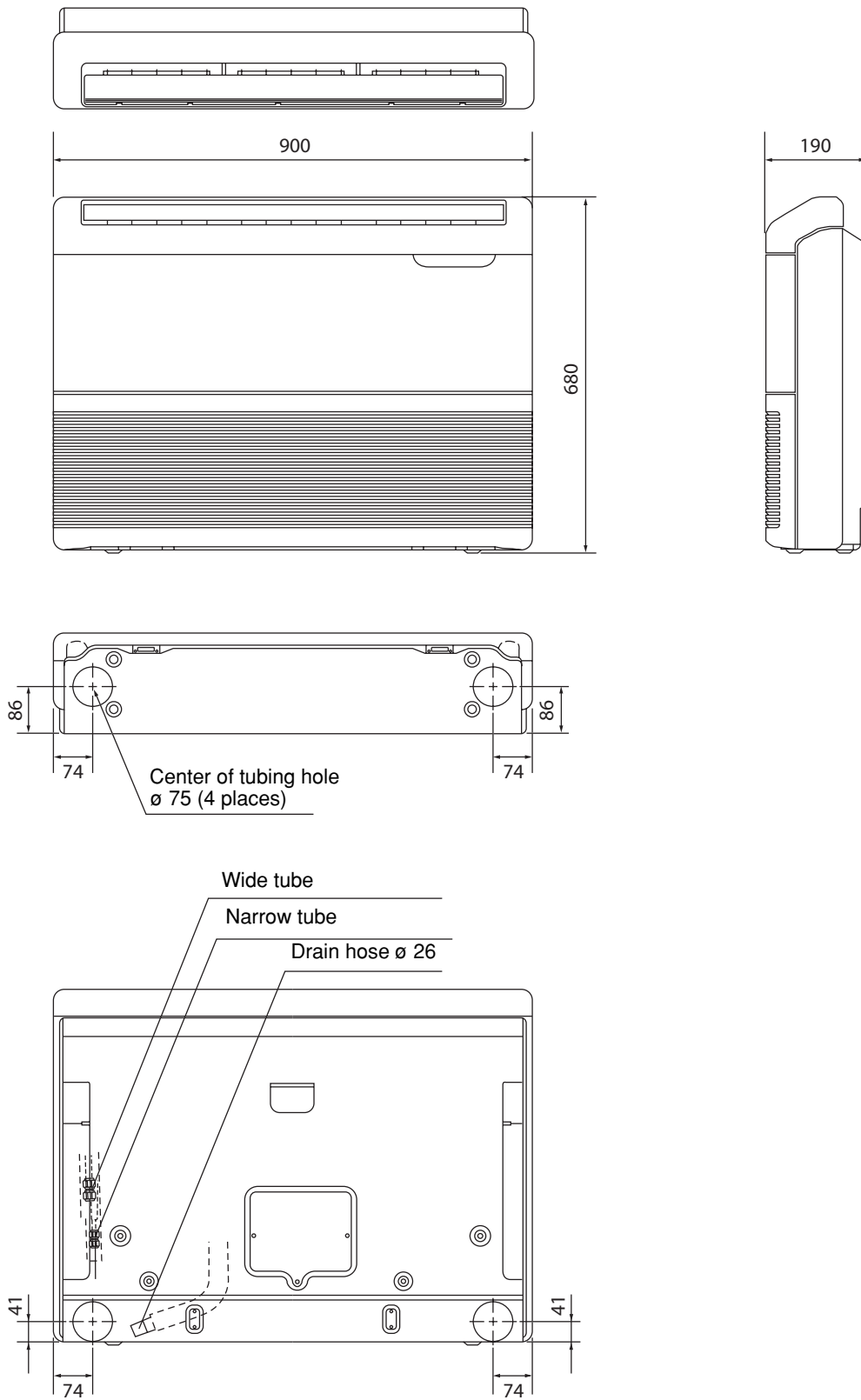

Unit : mm

3. HOW TO INSTALL THE UNIT

Minimum operation and maintenance area. (fig. 4-1)

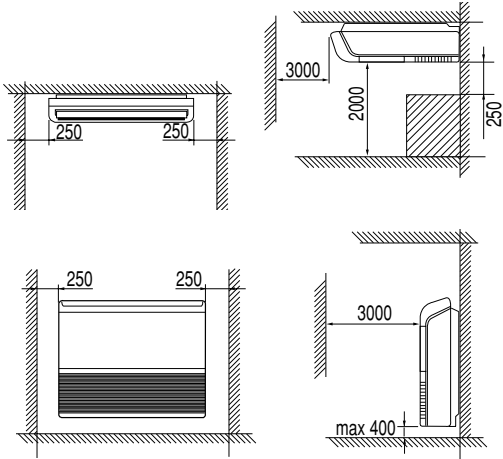

Fig. 3-1

Find the place for the installation. The unit can be connected in four different positions: at the right-back side, at the left-back side, at the bottom on the right or on the left. (fig. 3-2)

Floor installation.

Bend the fullscall diagram, level it and mark the holes to drill (pipes, condensate drain pipe, cradle). (fig. 3-3)

Wall installation.

Place the fullscall diagram, level it and mark the holes to drill (pipes and rawl plugs). (fig. 3-4)

Under ceiling installation.

Place the fullscall diagram and mark the holes to drill (pipes on vertical wall or under-ceiling, condensate drain pipe, rawl plugs).

In this case the drainage-tube connection cannot be executed on the back. (fig. 3-5)

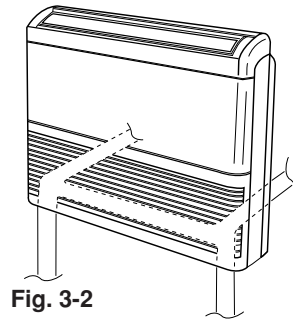

Fig. 3-2

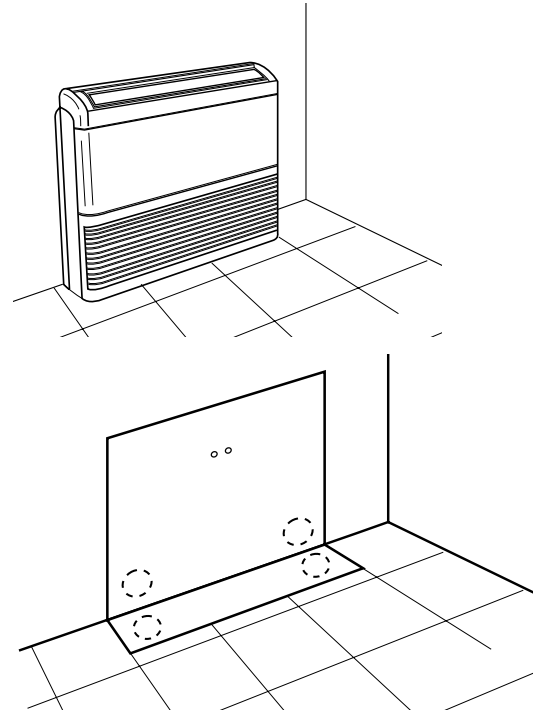

Fig. 3-3

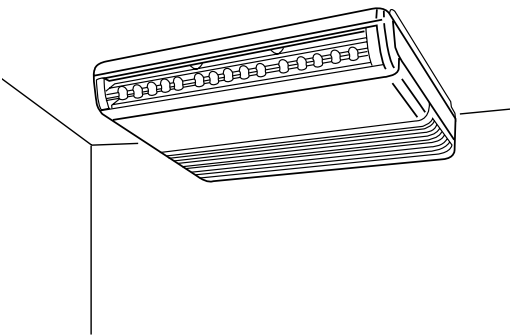

Fig. 3-5

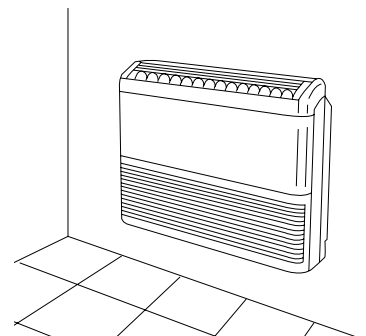
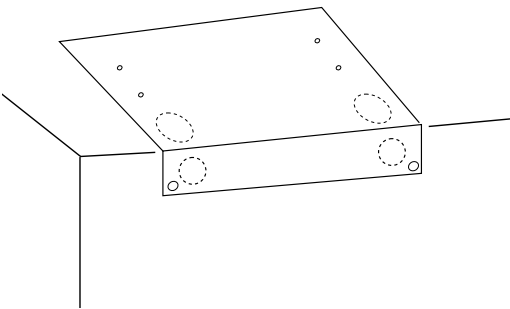
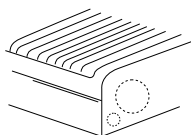

Fig. 3-4



Drill a 80 mm hole, insert a PVC pipe. (fig. 3-6)

Remove the return air grille releasing it from the side guides and the central elastic stop. (fig. 3-7)

Open a pre-punched hole for the pipe passage (work from outside).(fig. 3-8)

Floor installation.

Predispose the fixing of the bracket.
 Check if the quantity and the rawl plugs type supplied are the proper ones for fixing the unit on the wall.
 Attach the bracket to the wall with the screws, but do not tighten the screws all the way, so that you can move the bracket for final adjustment. Adjust the bracket as shown in the figure, then finish tightening the screws. Hang the unit on the bracket as shown in the figure. (fig. 3-9)

Wall installation.

Use rawl plugs suitable to the wall consistence and four threaded bars of suitable length. (not supplied). (fig. 3-10)

Under ceiling installation.

Use rawl plugs suitable to the wall consistence and four threaded bars of suitable length. (not supplied).

Open a pre-punched hole for the pipe passage (back or bottom panel) and the condensate drain hole. Fix the unit under the ceiling. (fig. 3-11)

Predispose the condensate drain pipe with a positive slope to the outside. Cut the angle of the return air grille as marked on the internal side. (fig. 3-12)

Remove the side panel to operate on the connecting pipes. Predispose the condensate drain pipe and attach it to the fan housing if necessary. (fig. 3-13)

Install the condensate drain to the outside with a positive slope. (fig. 3-14)

Fix both side panels and reassemble the return air grille. (fig. 3-15)

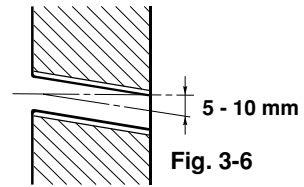

Fig. 3-6

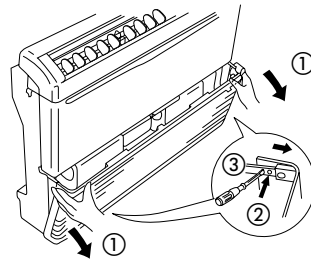

Fig. 3-7

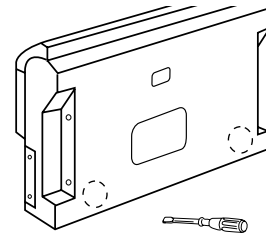

Fig. 3-8

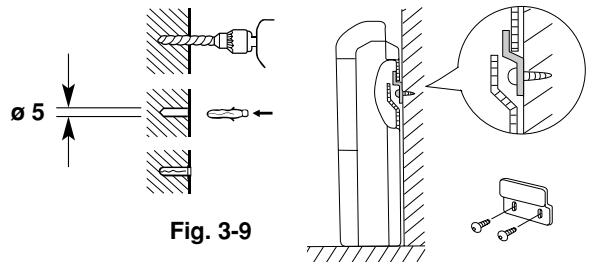

Fig. 3-9

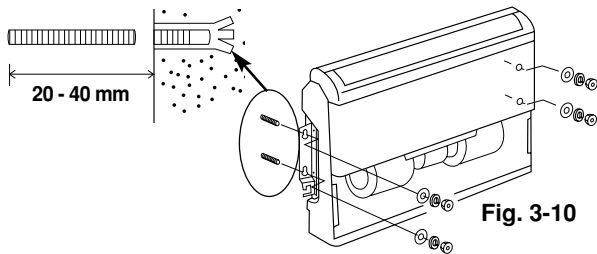

Fig. 3-10

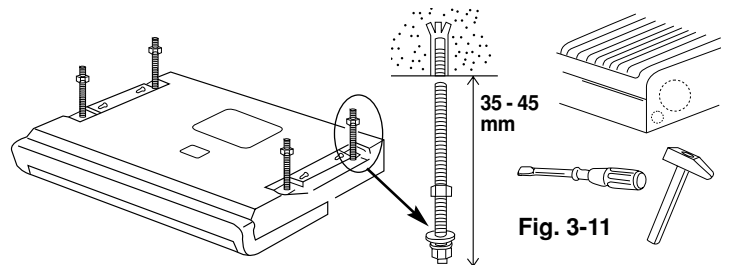

Fig. 3-11

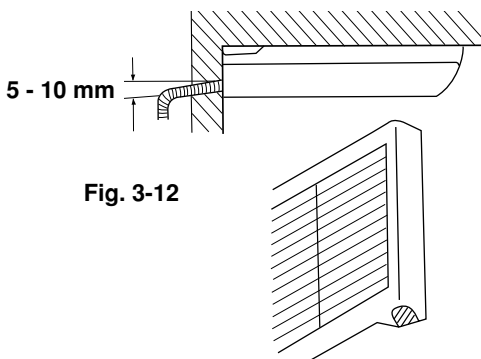

Fig. 3-12

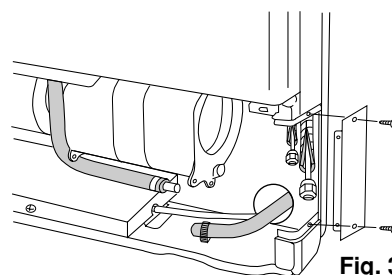

Fig. 3-13

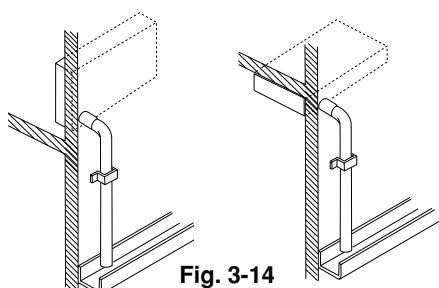

Fig. 3-14

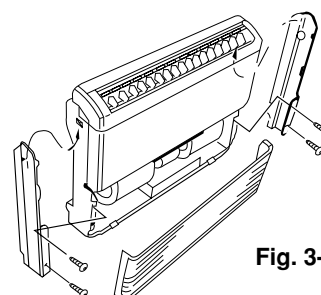

Fig. 3-15

4. ELECTRICAL WIRING

4-1. General Precautions on Wiring

- (1) Before wiring, confirm the rated voltage of the unit as shown on its nameplate, then carry out the wiring closely following the wiring diagram.
- (2) Provide a power outlet to be used exclusively for each unit, and a power supply disconnect and circuit breaker for overcurrent protection should be provided in the exclusive line.
- (3) To prevent possible hazards from insulation failure, the unit must be grounded.
- (4) Each wiring connection must be done in accordance with the wiring system diagram. Wrong wiring may cause the unit to misoperate or become damaged.
- (5) Do not allow wiring to touch the refrigerant tubing, compressor, or any moving parts of the fan.
- (6) Unauthorized changes in the internal wiring can be very dangerous. The manufacturer will accept no responsibility for any damage or misoperation that occurs as a result of such unauthorized changes.
- (7) Regulations on wire diameters differ from locality to locality. For field wiring rules, please refer to your LOCAL ELECTRICAL CODES before beginning.
You must ensure that installation complies with all relevant rules and regulations.
- (8) To prevent malfunction of the air conditioner caused by electrical noise, care must be taken when wiring as follows:
 - The remote control wiring and the inter-unit control wiring should be wired apart from the inter-unit power wiring.
 - Use shielded wires for inter-unit control wiring between units and ground the shield on both sides.
- (9) If the power supply cord of this appliance is damaged, it must be replaced by a repair shop appointed by the manufacture, because special purpose tools are required.

4-2. Recommended Wire Length and Wire Diameter for Power Supply System

Outdoor unit

	(A) Power supply		Time delay fuse or circuit capacity
	Wire size	Max. length	
GRFP255L(R)5IA-	4 mm ²	24 m	25 A
GRFP365L(R)5IA-	4 mm ²	22 m	25 A
GRFP485L(R)5IA-	6 mm ²	30 m	35 A

Indoor unit

(B) Power supply	Time delay fuse or circuit capacity
2.5 mm ²	
Max. 130 m	10

Control wiring

(C) Inter-unit (between outdoor and indoor units) control wiring	(D) Remote control wiring	(E) Control wiring for group control
0.75 mm ² (AWG #18) Use shielded wiring*	0.75 mm ² (AWG #18) Use shielded wiring	0.75 mm ² (AWG #18) Use shielded wiring
Max. 1,000 m	Max. 500 m	Max. 500 m (Total)

NOTE

* With ring-type wire terminal.

4-3. Wiring System Diagrams

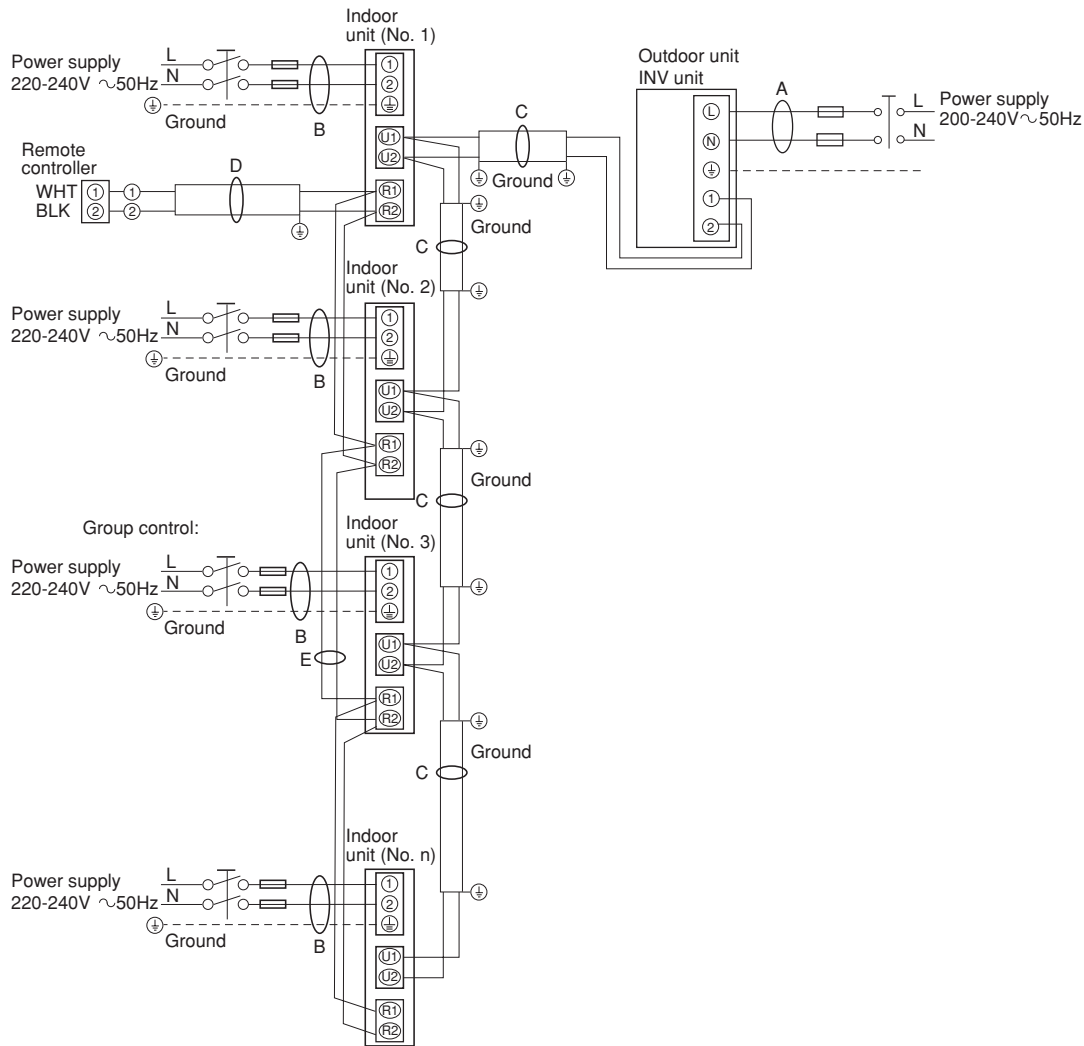

NOTE

- (1) Refer to Section 5-2. "Recommended Wire Length and Wire Diameter for Power Supply System" for the explanation of "A," "B," "C," "D," and "E," in the above diagrams.
- (2) The basic connection diagram of the indoor unit shows the 7P terminal board, so the terminal boards in your equipment may differ from the diagram.
- (3) Refrigerant Circuit (R.C.) address should be set before turning the power on.

7P terminal board

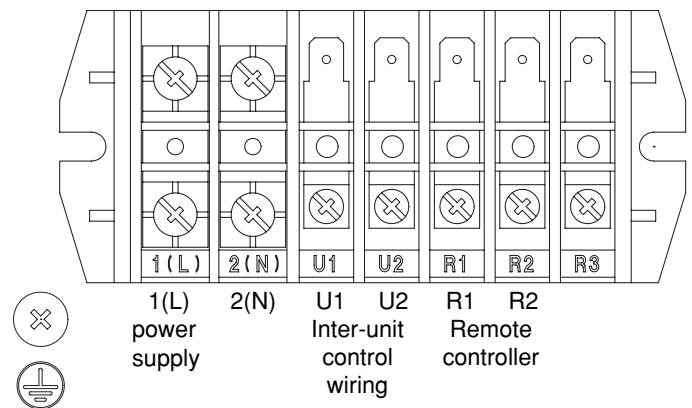



CAUTION

(1) When linking outdoor units in a network (S-net link system), disconnect the terminal extended from the short plug (CN003, 2P Black, location: right bottom on the outdoor main control PCB) from all outdoor units except any one of the outdoor units.

(When shipping: In shorted condition.)

Otherwise the communication of S-net link system is not performed. For a system without link (no connection wiring between outdoor units), do not remove the short plug.

(2) Do not install the inter-unit control wiring in a way that forms a loop. (Fig. 4-1)

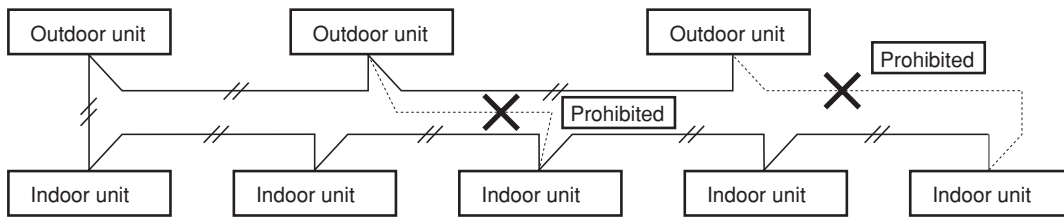

Fig. 4-1

(3) Do not install inter-unit control wiring such as star branch wiring. Star branch wiring causes mis-address setting.

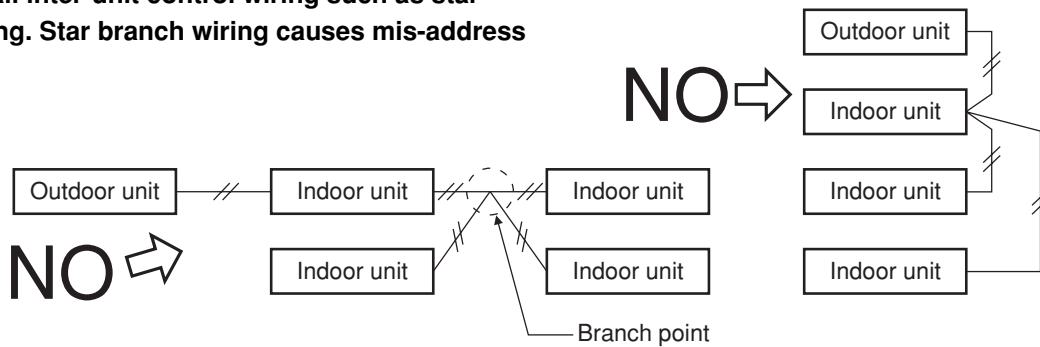

Fig. 4-2

(4) If branching the inter-unit control wiring, the number of branch points should be 16 or fewer. (Branches less than 1 m are not included in the total branch number.) (Fig. 4-3)

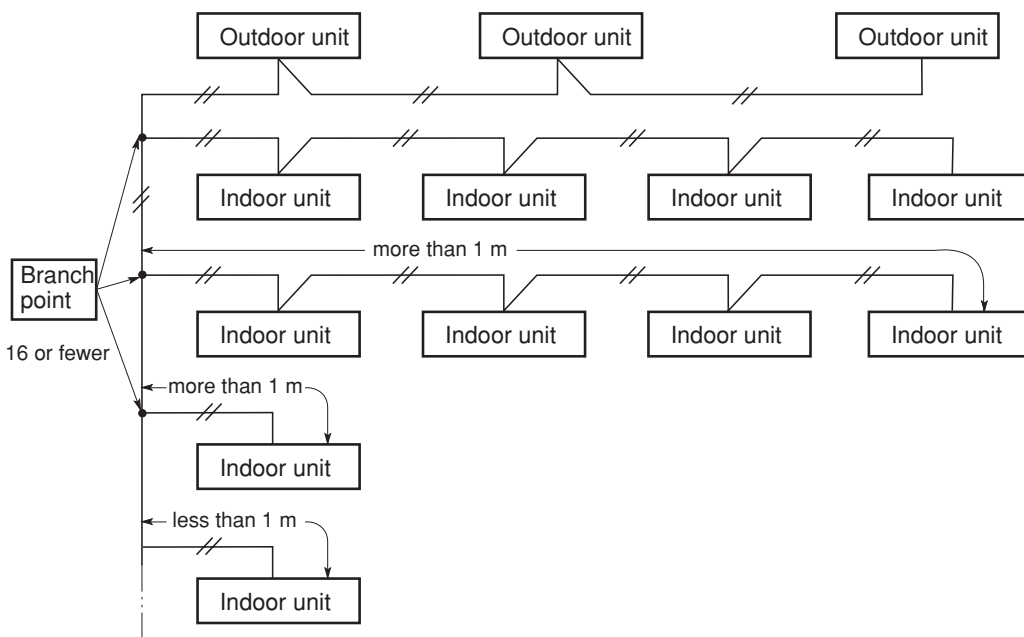

Fig. 4-3

(5) Use shielded wires for inter-unit control wiring (c) and ground the shield on both sides, otherwise misoperation from noise may occur.

(Fig. 4-4)

Connect wiring as shown in Section “4-3. Wiring System Diagrams.”



WARNING

Loose wiring may cause the terminal to overheat or result in unit malfunction. A fire hazard may also exist. Therefore, ensure that all wiring is tightly connected.

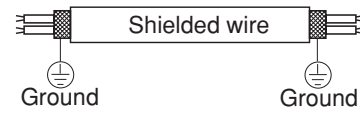

Fig. 4-4

When connecting each power wire to the terminal, follow the instructions on “How to connect wiring to the terminal” and fasten the wire securely with the fixing screw of the terminal plate.

How to connect wiring to the terminal

■ For stranded wiring

- (1) Cut the wire end with cutting pliers, then strip the insulation to expose the stranded wiring about 10 mm and tightly twist the wire ends. (Fig. 4-5)
- (2) Using a Phillips head screwdriver, remove the terminal screw(s) on the terminal plate.
- (3) Using a ring connector fastener or pliers, securely clamp each stripped wire end with a ring pressure terminal.
- (4) Place the ring pressure terminal, and replace and tighten the removed terminal screw using a screwdriver. (Fig. 4-6)

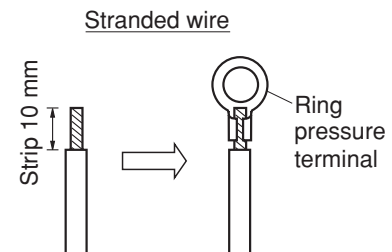

Fig. 4-5

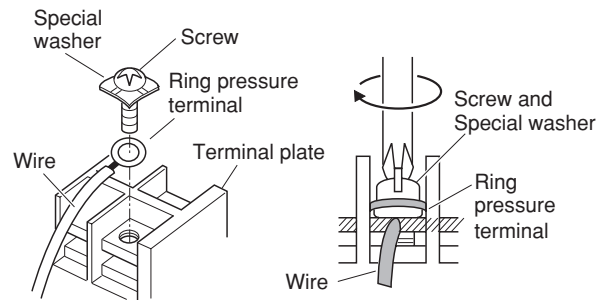

Fig. 4-6

5. HOW TO PROCESS TUBING

The narrow tubing side is connected by a flare nut, and the wide tubing side is connected by brazing.

5-1. Connecting the Refrigerant Tubing

Use of the Flaring Method

Many of conventional split system air conditioners employ the flaring method to connect refrigerant tubes which run between indoor and outdoor units. In this method, the copper tubes are flared at each end and connected with flare nuts.

Flaring Procedure with a Flare Tool

- (1) Cut the copper tube to the required length with a tube cutter. It is recommended to cut approx. 30 – 50 cm longer than the tubing length you estimate.
- (2) Remove burrs at the end of the copper tube with a tube reamer or file. This process is important and should be done carefully to make a good flare. (Fig. 5-1)

NOTE

When reaming, hold the tube end downward and be sure that no copper scraps fall into the tube. (Fig. 5-2)

- (3) Remove the flare nut from the unit and be sure to mount it on the copper tube.
- (4) Make a flare at the end of copper tube with a flare tool.* (Fig. 5-3)
(*Use "RIGID®" or equivalent.)

NOTE

A good flare should have the following characteristics:

- inside surface is glossy and smooth
- edge is smooth
- tapered sides are of uniform length

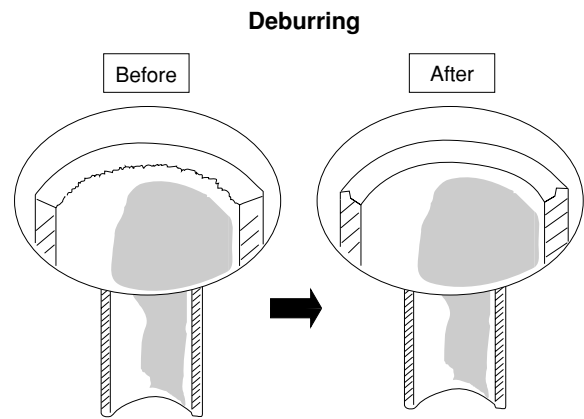

Fig. 5-1

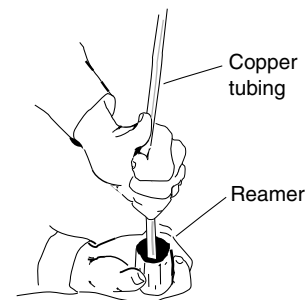

Fig. 5-2

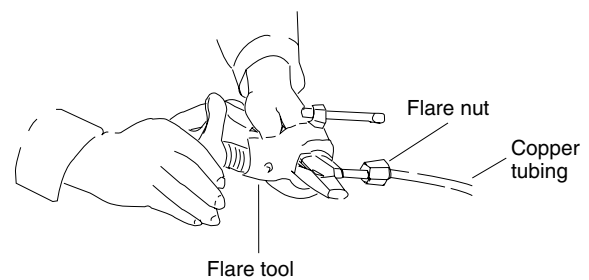

Fig. 5-3

Caution Before Connecting Tubes Tightly

- (1) Apply a sealing cap or water-proof tape to prevent dust or water from entering the tubes before they are used.
 - (2) Be sure to apply refrigerant lubricant to the matching surfaces of the flare and union before connecting them together. This is effective for reducing gas leaks. (Fig. 5-4)
 - (3) For proper connection, align the union tube and flare tube straight with each other, then screw in the flare nut lightly at first to obtain a smooth match. (Fig. 5-5)
- Adjust the shape of the narrow tube (liquid tube) using a tube bender at the installation site and connect it to the narrow tubing side (liquid tubing side) valve using a flare.

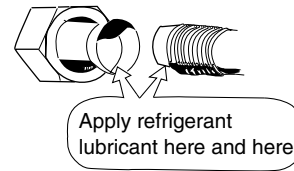

Fig. 5-4

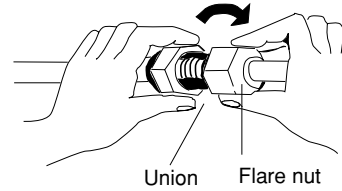

Fig. 5-5

Cautions During Brazing

- Replace air inside the tube with nitrogen gas to prevent copper oxide film from forming during the brazing process. (Oxygen, carbon dioxide and Freon are not acceptable.)
- Do not allow the tubing to get too hot during brazing. The nitrogen gas inside the tubing may overheat, causing refrigerant system valves to become damaged. Therefore allow the tubing to cool when brazing.
- Use a reducing valve for the nitrogen cylinder.
- Do not use agents intended to prevent the formation of oxide film. These agents adversely affect the refrigerant and refrigerant oil, and may cause damage or malfunctions.

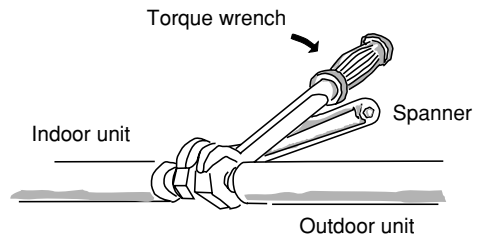

Fig. 5-6

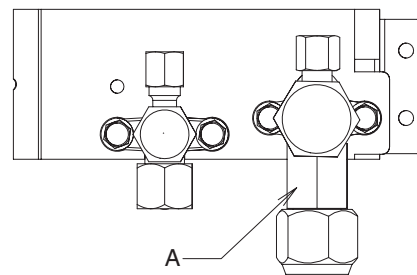

Fig. 5-7

5-2. Connecting Tubing Between Indoor and Outdoor Units

- (1) Tightly connect the indoor-side refrigerant tubing extended from the wall with the outdoor-side tubing.
- (2) To fasten the flare nuts, apply specified torque as at right:
 - When removing the flare nuts from the tubing connections, or when tightening them after connecting the tubing, be sure to use 2 monkey wrenches or spanners as shown. (Fig. 5-6)
 - If the flare nuts are over-tightened, the flare may be damaged, which could result in refrigerant leakage and cause injury or asphyxiation to room occupants.
 - When removing or tightening the wide tube flare nut, use 2 monkey wrenches together: one at the wide tube flare nut and one at part A. (Fig. 5-7)
 - For the flare nuts at tubing connections, be sure to use the flare nuts that were supplied with the unit, or else flare nuts for R410A (type 2). The refrigerant tubing that is used must be of the correct wall thickness as shown in the table at right.

Tube diameter	Tightening torque, approximate	Tube thickness
φ6.35 (1/4")	14 – 18 N · m (140 – 180 kgf · cm)	0.8 mm
φ9.52 (3/8")	34 – 42 N · m (340 – 420 kgf · cm)	0.8 mm
φ12.7 (1/2")	49 – 61 N · m (490 – 610 kgf · cm)	0.8 mm
φ15.88 (5/8")	68 – 82 N · m (680 – 820 kgf · cm)	1.0 mm

Because the pressure is approximately 1.6 times higher than conventional refrigerant pressure, the use of ordinary flare nuts (type 1) or thin-walled tubes may result in tube rupture, injury, or asphyxiation caused by refrigerant leakage.

- In order to prevent damage to the flare caused by over-tightening of the flare nuts, use the table above as a guide when tightening.
- When tightening the flare nut on the narrow tube, use a monkey wrench with a nominal handle length of 200 mm.

- Do not use a spanner to tighten the valve stem caps. Doing so may damage the valves.
- Depending on the installation conditions, applying excessive torque may cause the nuts to crack.

Precautions for Packed Valve Operation

- If the packed valve is left for a long time with the valve stem cap removed, refrigerant will leak from the valve. Therefore, do not leave the valve stem cap removed.
- Use a torque wrench to securely tighten the valve stem cap.
- Valve stem cap tightening torque:.

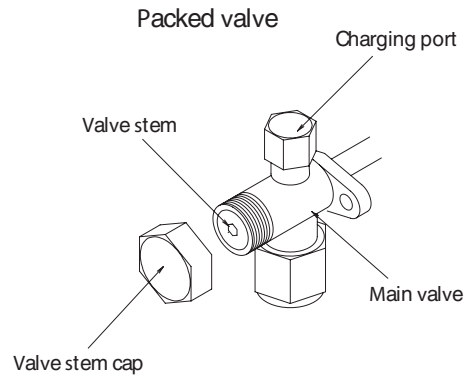

Fig. 5-8

Charging port	8 – 10 Nm (80 - 100 kgfcm)
9,52 mm (Narrow side)	19 – 21 N m (190 - 210 kgf cm)
15,88 mm (Wide side)	28 – 32 N m (280 - 320 kgf cm)

5-3. Insulating the Refrigerant Tubing

Tubing Insulation

- Thermal insulation must be applied to all unit tubing, including distribution joint (purchased separately).
 - * For gas tubing, the insulation material must be heat resistant to 120°C or above. For other tubing, it must be heat resistant to 80°C or above.
- Insulation material thickness must be 10 mm or greater.
- If the conditions inside the ceiling exceed DB 30°C and RH 70%, increase the thickness of the gas tubing insulation material by 1 step.

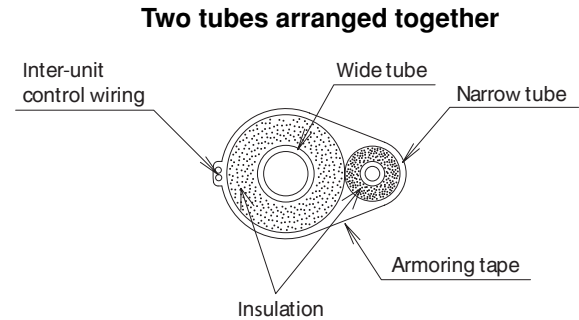

Fig. 5-9

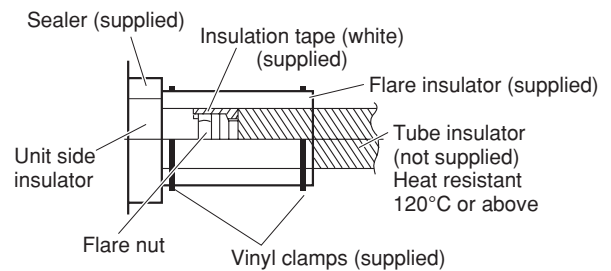

Fig. 5-10



CAUTION

If the exterior of the outdoor unit valves has been finished with a square duct covering, make sure you allow sufficient space to use the valves and to allow the panels to be attached and removed.

Taping the flare nuts

Wind the white insulation tape around the flare nuts at the wide tube connections. Then cover up the tubing connections with the flare insulator, and fill the gap at the union with the supplied black insulation tape. Finally, fasten the insulator at both ends with the supplied vinyl clamps. (Fig. 5-10)

Insulation material

The material used for insulation must have good insulation characteristics, be easy to use, be age resistant, and must not easily absorb moisture.



CAUTION

After a tube has been insulated, never try to bend it into a narrow curve because it can cause the tube to break or crack.

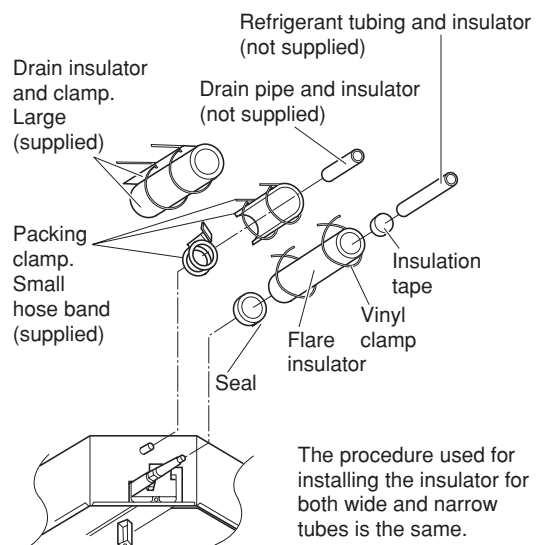

Fig. 5-11

Never grasp the drain or refrigerant connecting outlets when moving the unit.

5-4. Taping the Tubes

- (1) At this time, the refrigerant tubes (and electrical wiring if local codes permit) should be taped together with armoring tape in 1 bundle. To prevent the condensation from overflowing the drain pan, keep the drain hose separate from the refrigerant tubing.
- (2) Wrap the armoring tape from the bottom of the outdoor unit to the top of the tubing where it enters the wall. As you wrap the tubing, overlap half of each previous tape turn.
- (3) Clamp the tubing bundle to the wall, using 1 clamp approx. each meter. (Fig. 5-10)

NOTE

Do not wind the armoring tape too tightly since this will decrease the heat insulation effect. Also ensure that the condensation drain hose splits away from the bundle and drips clear of the unit and the tubing.

5-5. Finishing the Installation

After finishing insulating and taping over the tubing, use sealing putty to seal off the hole in the wall to prevent rain and draft from entering. (Fig. 5-11)

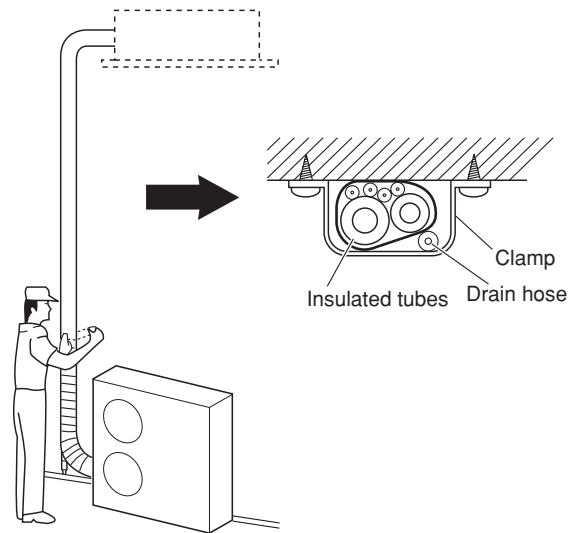

Fig. 5-10

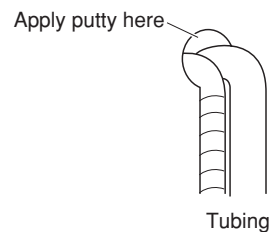

Fig. 5-11

6. SPECIAL REMARKS

■ HOW TO INSTALL THE WIRELESS REMOTE CONTROLLER RECEIVER K70D038ZAA

6-1 Installing the Control Unit

- (1) Fix the operation controller on the metal plate near the Elec. Junction Box.
Use the provided screws.
- (2) Connect the wireless controller 6 poles wire group with the one coming from indoor unit receiver.
- (3) Connect the 2P wire to the terminal base in the electrical junction box (R1 - R2).

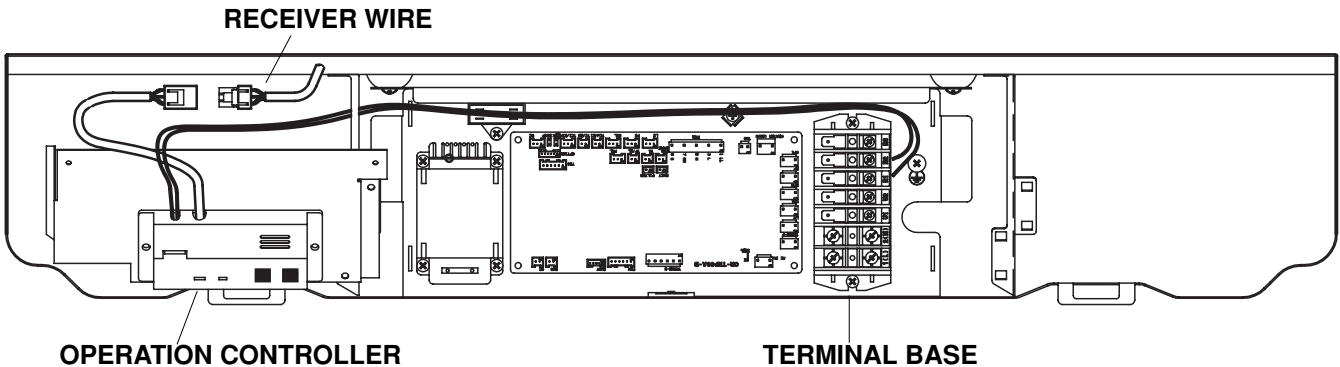





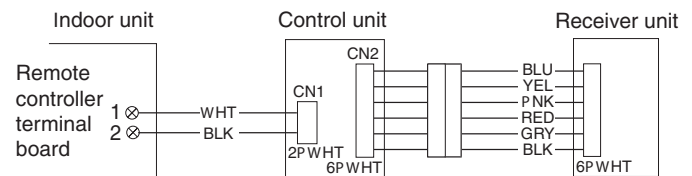

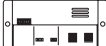

NOTE

- Do not twist the control wiring with the power wiring because this may cause malfunction.
- Install a noise filter or take other appropriate action if electrical noise affects the power supply circuit of the unit.



6-2 Accessories

No.	Parts	Q'ty	No.	Parts	Q'ty
1	Control unit 	1	6	Spacer 	2
2	Receiver unit (do not utilize) 	1	7	Tapping screw 4 x 10 	4
3	Remote control unit 	1	8	Tapping screw 4 x 16 Truss-head P Phillips 	2
4	Remote control holder 	1	9	Vinyl clamp L 150 	3
5	AAA alkaline battery 	2			

Care and Cleaning



WARNING

1. For safety, be sure to turn the air conditioner off and also to disconnect the power before cleaning.
2. Do not pour water on the indoor unit to clean it. This will damage the internal components and cause an electric shock hazard.

Air intake and outlet side (Indoor unit)

Clean the air intake and outlet side of the indoor unit with a vacuum cleaner brush, or wipe them with a clean, soft cloth.

If these parts are stained, use a clean cloth moistened with a mild liquid detergent. When cleaning the air outlet side, be careful not to force the vanes out of place.



CAUTION

1. Never use solvents or harsh chemicals when cleaning the indoor unit. Do not wipe plastic parts using very hot water.
2. Some metal edges and the fins are sharp and may cause injury if handled improperly; be especially careful when you clean these parts.
3. The internal coil and other components of the outdoor unit must be cleaned every year. Consult your dealer or service center.

Air filter

The air filter collects dust and other particles from the air and should be cleaned once every two weeks or when the filter indication (■) on the display of the remote control unit (wired type) shows that the filter needs cleaning. If the filter gets blocked, the efficiency of the air conditioner drops greatly.

How to remove the filter

1. Grasp both ends of the air intake grille and pull to open it.
2. Hold the air filter by the tab and pull it upward. Clean the air filter.
3. When replacing the filter, make sure that the FRONT mark is facing you. Reinsert the filter into place and close the air intake grille.

FILTER CLEANING

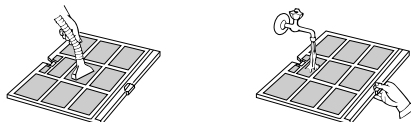

Use a vacuum cleaner to remove light dust. If there is sticky dust on the filter, wash the filter in lukewarm, soapy water, rinse it in clean water, and dry it.



"AIR CLEAN" FILTER (ACCESSORY SUPPLIED ON REQUEST)

- The air filter is to be added by springs to the standard filter.
- It is made of two layers:
 - the first layer consists in a synthetic honey comb high efficiency media to remove the dust and purifying the air.
 - the second layer in charcoal media deodorizing the ambient air.

How to install the "Air clean" filter.

1. Open the unit intake air grille and pull out the standard air filter.
2. Apply on the rear side of the filter the two springs supplied with the accessory.
3. Fix the "air clean" filter by the springs.
4. Insert the two air filters one over the other and close the intake grille.

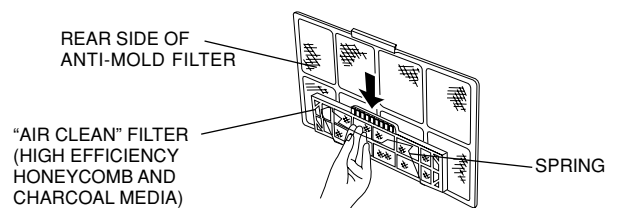

Troubleshooting

If your air conditioner does not work properly, first check the following points before requesting service. If it still does not work properly, contact your dealer or a service center.

Trouble	Possible Cause	Remedy
Air conditioner does not run at all.	<ol style="list-style-type: none"> 1. Power failure. 2. Leakage circuit breaker has tripped. 3. Line voltage is too low. 4. Operation button is turned off. 5. The wired remote control unit or heat pump is malfunctioning. (The inspection mark  and the letters E, F, H, L, P in combination with numbers appear on the LCD of the wired remote control unit.) 	<ol style="list-style-type: none"> 1. After a power outage, press ON/OFF operation button on the wired remote control unit. 2. Contact service center. 3. Consult your electrician or dealer. 4. Press the button again. 5. Consult your dealer.
Compressor runs but soon stops.	<ol style="list-style-type: none"> 1. Obstruction in front of condenser coil. 	<ol style="list-style-type: none"> 1. Remove obstruction.
Poor cooling (or heating) performance.	<ol style="list-style-type: none"> 1. Dirty or clogged air filter. 2. Heat source or many people in room. 3. Doors and/or windows are open. 4. Obstacle near air intake or air discharge port. 5. Thermostat is set too high for cooling (or too low for heating). 6. (Defrosting system does not work.) 	<ol style="list-style-type: none"> 1. Clean air filter to improve the airflow. 2. Eliminate heat source if possible. 3. Shut them to keep the heat (or cold) out. 4. Remove it to ensure good airflow. 5. Set the temperature lower (or higher). 6. (Consult your dealer.)

Tips for Energy Saving

- Avoid**
- **Do not block the air intake and outlet of the unit. If either is obstructed, the unit will not work well, and may be damaged.**
 - Do not let direct sunlight into the room. Use sunshades, blinds or curtains. If the walls and ceiling of the room are warmed by the sun, it will take longer to cool the room.
- Do**
- Always try to keep the air filter clean. (Refer to "Care and Cleaning".) A clogged filter will impair the performance of the unit.
 - To prevent conditioned air from escaping, keep windows, doors and any other openings closed.

NOTE

Should the power fail while the unit is running

If the power supply for this unit is temporarily cut off, the unit will automatically resume operation once power is restored using the same settings before the power was cut off.

Entretien et nettoyage



AVERTISSEMENT

1. Pour toute sécurité, éteignez le climatiseur et débranchez-le de la prise secteur.
2. Ne versez pas d'eau sur l'unité intérieure pour la nettoyer. Cela pourrait abîmer les composants internes et provoquer des décharges électriques.

L'arrivée d'air et la sortie d'air (unité intérieure)

Nettoyez l'arrivée d'air et la sortie de l'unité intérieure avec la brosse d'un aspirateur ou les essuyer avec un chiffon propre et doux.

Si ces parties sont sales, nettoyez-les avec un chiffon propre humecté d'un détergent liquide doux. Quand la grille est nettoyée, faites attention de ne pas modifier la place des ailettes en frottant.



ATTENTION

1. Ne utilisez jamais de dissolvants ni de produits chimiques puissants lorsque l'unité intérieure est nettoyée. N'essuyez pas les pièces en plastique avec de l'eau très chaude.
2. Certains bords métalliques et les ailettes étant coupants, ils doivent être manipulés avec précaution lors du nettoyage sous peine de provoquer des blessures.
3. La bobine interne et les autres composants de l'unité extérieure doivent être nettoyés tous les ans. Consultez le concessionnaire ou un service après-vente.

Filtre à air

Le filtre à air recueille la poussière et les particules se trouvant dans l'air et doit être nettoyé au moins une fois tous les deux semaines ou lorsque le symbole du filtre (☐) affiché sur la télécommande (avec fil) indique que le filtre doit être nettoyé. Si le filtre est bloqué, l'efficacité du climatiseur diminue nettement.

Comment retirer le filtre

1. Ouvrir la grille d'arrivée d'air en la tirant vers soi.
2. Tenir le filtre à air par la languette et le tirer vers le haut. Nettoyer le filtre à air.
3. Quand on remet le filtre en place, vérifier que le repère FRONT (avant) est bien tourné vers soi.

Remettre le filtre dans son logement et refermer la grille d'entrée d'air.

NETTOYAGE DU FILTRE

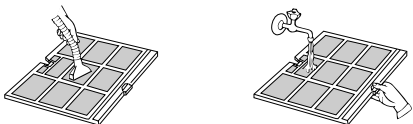

Utiliser un aspirateur pour enlever la poussière. Si la poussière colle au filtre, laver le filtre avec de l'eau tiède et savonneuse, le rincer à l'eau claire et le sécher.

FILTRE AIR A HAUTE EFFICACITE (ACCESSOIRE SUR DEMANDE)

- Le filtre doit être monté en addition du filtre standard
- Il est formé de deux couches:
 - La première fonctionne comme filtre à haute efficacité et elle retient aussi les petites particules dans l'air.
 - La deuxième couche est formée de charbon actif qui purifie l'air des odeurs.

Application de l'accessoire

1. Ouvrir la grille d'arrivée d'air et extraire le filtre qui est fourni avec l'unité.
2. Monter les ressorts fournis sur l'arrière du filtre standard.
3. Monter sur chaque filtre son filtre à haute efficacité: il est arrêté par le ressort.
4. Enchasser le double-filtre dans son logement et fermer la grille d'arrivée d'air.

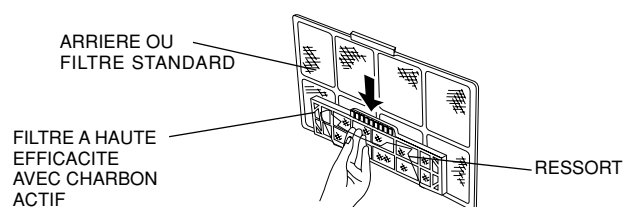
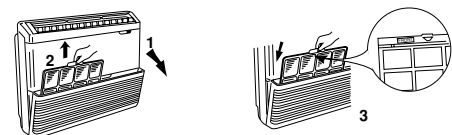

Guide de dépannage

Si le climatiseur ne fonctionne pas correctement, effectuez les vérifications suivantes avant de faire appel à un réparateur. Si le problème persiste, prenez contact avec votre concessionnaire ou avec un service après-vente.

Panne	Cause possible	Remède
Le climatiseur ne fonctionne pas du tout.	<ol style="list-style-type: none">1. Coupure de courant.2. Le disjoncteur a fonctionné.3. Tension de ligne trop basse.4. Le bouton de fonctionnement est en position Off.5. La télécommande avec fil ou la pompe thermique ne fonctionne pas correctement. (La marque d'inspection  et les lettres E, F, H, L, P ainsi que des numéros apparaissent sur l'affichage à cristaux liquides de la télécommande avec fil.)	<ol style="list-style-type: none">1. Après une panne de courant, appuyez sur le bouton de marche/arrêt de fonctionnement de la télécommande avec fil.2. Prenez contact avec un service après-vente.3. Consultez un électricien ou le concessionnaire.4. Appuyez à nouveau sur le bouton.5. Consultez le concessionnaire.
Le compresseur se met en marche mais il s'arrête aussitôt.	<ol style="list-style-type: none">1. Il y a un obstacle devant la bobine du condensateur.	<ol style="list-style-type: none">1. Retirez ce qui fait obstruction.
Refroidissement (ou chauffage) insuffisant.	<ol style="list-style-type: none">1. Filtre à air sale ou obstrué.2. Source de chaleur ou trop de monde dans la pièce.3. Portes et/ou fenêtres ouvertes.4. Obstacle devant l'arrivée ou la sortie d'air.5. Le thermostat est réglé sur une température trop élevée pour le refroidissement (ou trop basse pour le chauffage).6. (Le dégivrage du système ne fonctionne pas.)	<ol style="list-style-type: none">1. Nettoyez le filtre à air afin d'améliorer la circulation d'air.2. Si possible, éliminez la source de chaleur.3. Fermez-les pour empêcher la pénétration d'air chaud (ou froid).4. Retirez l'obstacle pour assurer une bonne circulation d'air.5. Réglez la température plus bas (ou plus haut).6. (Consultez le concessionnaire.)

Conseils pour économiser l'énergie

- À éviter :**
- **Obstruer les arrivées et les sorties d'air de l'appareil. Si elles sont bouchées, l'appareil ne fonctionnera pas de façon satisfaisante et il risque d'être endommagé.**
 - Laisser le soleil pénétrer directement dans la pièce. Utiliser des persiennes ou des rideaux. Si les murs et le plafond de la pièce sont chauds sous l'action du soleil, il faudra plus longtemps pour refroidir la pièce.

- Choses à faire**
- Toujours maintenir le filtre à air propre. (Voir « Entretien et nettoyage ».) Un filtre obstrué risque d'affecter le fonctionnement de l'unité.
 - Pour éviter que l'air refroidi ne s'échappe, maintenir toutes les fenêtres, portes et autres ouvertures fermées.

REMARQUE

Si une panne de courant se produit lorsque l'unité fonctionne

Si l'alimentation de cette unité est temporairement arrêtée, l'unité se remettra en marche, après rétablissement de l'alimentation, avec les mêmes réglages qu'avant la panne de courant.

Pflege und Reinigung



WARNUNG

1. Aus Sicherheitsgründen darauf achten, das Gerät vor dem Reinigen auszuschalten und es außerdem vom Netz zu trennen.
2. Kein Wasser auf die Inneneinheit schütten, um diese zu reinigen. Dadurch werden die inneren Bauteile beschädigt, und es besteht Stromschlaggefahr.

Luftinlass- und -auslassseite (Inneneinheit)

Reinigen Sie die Luftinlass- und -auslassseite der Inneneinheit mit einer Staubsaugerbürste bzw. wischen Sie sie mit einem sauberen weichen Tuch ab.

Wenn die erwähnten Teile schmutzig sind, diese mit einem sauberen Tuch abwischen, das mit einer neutralen Reinigungsflüssigkeit befeuchtet ist. Achten Sie beim Reinigen der Luftauslassseite darauf, die Luftleitlamellen nicht gewaltsam zu verstellen.



VORSICHT

1. Verwenden Sie niemals Lösungsmittel oder starke Chemikalien, um die Inneneinheit zu reinigen. Wischen Sie die Plastikteile nicht mehr sehr heißem Wasser ab.
2. Gewisse Metallkanten und die Kondensatorrippen sind scharf und können Verletzungen verursachen, wenn sie nicht richtig gehandhabt werden; beim Reinigen dieser Teile besonders vorsichtig sein.
3. Die innere Wärmeaustauscherschlange und andere Bauteile der Außeneinheit müssen einmal im Jahr gereinigt werden. Wenden Sie sich dazu bitte an Ihren Fachhändler oder an eine Kundendienststelle.

Luftfilter

Der Luftfilter sammelt Staub und andere Teilchen aus der Luft und sollte einmal alle zwei Woche gereinigt werden, bzw. wenn die Filteranzeige () auf dem Display der (verdrahteten) Fernbedienung anzeigt, dass der Filter gereinigt werden sollt. Falls der Filter verstopft ist, nimmt der Wirkungsgrad des Klimageräts stark ab.

Herausnehmen des Filters

1. Das Ansauggitter öffnen, indem Sie es gegen Sie ziehen.
2. Den Filter an der Lasche nehmen und nach oben herausziehen. Den Luftfilter reinigen.
3. Beim Wiedereinsatz des Filters in die Einheit ist darauf zu achten, daß die Aufschrift FRONT gegen Sie gerichtet ist. Den Filter in Sitz einsetzen und das Ansauggitter wiederschliessen.

FILTERREINIGUNG

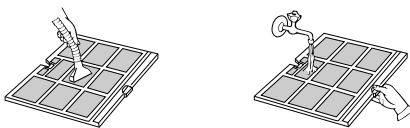

Den filter mit einem Staubsauger reinigen. Ist öliger Staub vorhanden, ist der Filter mit lauwarmen Seifenwasser zu waschen, zu spülen und trocknen zu lassen.

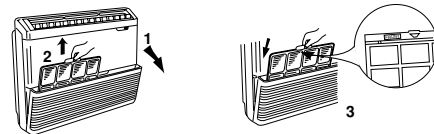

LUFTFILTER MIT GROßER LEISTUNGSFÄHIGKEIT (AUF ANFRAGE).

- Der Filter soll zum Standardfilter angebaut werden.
- Er besteht aus 2 Schichten:
 - Die erste funktioniert als Vorfilter mit großer Leistungsfähigkeit und hält auch die winzigen Teilchen in der Luft ab.
 - Die zweite Schicht besteht aus Aktivkohlen, die die Luft von Gerüchen reinigen.

Wie der Zubehör anzubauen ist.

1. Das Ansauggitter öffnen und den mit der Einheit gelieferten Filter herausziehen.
2. Die gelieferten Federn der Hinterseite des Standardfilters anmontieren.
3. Auf jedem Filter den entsprechenden "Filter mit großer Leistungsfähigkeit" anmontieren; dieser wird von den Federn festgehalten.
4. Den Doppelfilter in den entsprechenden Schienen einsetzen und das Ansauggitter schliessen.

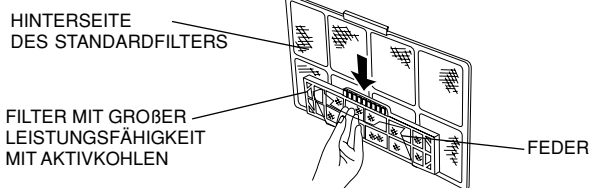

Fehlersuche

Wenn Ihr Klimagerät nicht richtig funktioniert, zuerst die folgenden Punkte überprüfen, bevor ein Kundendiensttechniker angefordert wird. Läßt sich die Störung nicht beheben, so wenden Sie sich bitte an Ihren Fachhändler oder an eine Kundendienststelle.

Störung	Mögliche Ursache	Abhilfe
Das Klimagerät läuft überhaupt nicht.	<ol style="list-style-type: none"> Keine Stromzufuhr. Der Fehlerstromschutzschalter wurde ausgelöst. Netzspannung ist zu niedrig. Die Betriebstaste ist ausgeschaltet. Fehlfunktion der verdrahtete Fernbedienung oder der Wärmepumpe. (Das Überprüfungszeichen  und die Buchstaben E, F, H, L, P zusammen mit Zahlen werden auf der LCD-Anzeige der verdrahtete Fernbedienung angezeigt.) 	<ol style="list-style-type: none"> Drücken Sie nach einem Stromausfall die Betriebstaste (ON/OFF) auf der verdrahteten Fernbedienung. Wenden Sie sich an eine Kundendienststelle. Lassen Sie sich von Ihrem Elektriker oder Fachhändler beraten. Die Taste erneut drücken. Lassen Sie sich von Ihrem Fachhändler beraten.
Kompressor läuft, kommt jedoch bald zum Stillstand.	<ol style="list-style-type: none"> Ein Hindernis befindet sich vor der Kondensatorschlange. 	<ol style="list-style-type: none"> Hindernis entfernen.
Schlechte Kühl- oder Heizleistung	<ol style="list-style-type: none"> Luftfilter ist schmutzig oder zugesetzt. Eine Wärmequelle oder viele Leute befinden sich im Raum. Türen und/oder Fenster sind geöffnet. Ein Hindernis befindet sich in der Nähe von Lufteinlass oder Luftauslass. Der Thermostat ist zu hoch zum Kühlen eingestellt (bzw. zu niedrig zum Heizen). (Abtausystem funktioniert nicht.) 	<ol style="list-style-type: none"> Luftfilter reinigen, um den Luftstrom zu verbessern. Die Wärmequelle möglichst abschalten. Diese schließen, damit keine Wärme (bzw. Kälte) von außen eindringt. Hindernis entfernen, um einen unbehinderten Luftstrom zu gewährleisten. Temperatur niedriger (bzw. höher) einstellen. (Lassen Sie sich von Ihrem Fachhändler beraten.)

Nützliche Hinweise für Energieeinsparung

- Zu vermeiden**
- **Blockieren Sie den Lufteinlass und -auslass des Gerätes nicht. Falls der Ein- oder Auslass blockiert wird, funktioniert das Gerät nicht richtig und kann sogar beschädigt werden.**
 - Setzen Sie den Raum nicht direkter Sonnenbestrahlung aus. Markisen, Jalousien oder Vorhänge verwenden. Wenn die Wände und Decke des Raumes Strahlungswärme von der Sonne aufnehmen, dauert es länger, den Raum zu kühlen.
- Ja**
- Den Luftfilter stets sauber halten. (Siehe den Abschnitt „Pflege und Reinigung“.) Ein verstopfter Filter beeinträchtigt die Leistung des Gerätes.
 - Um zu verhindern, dass klimatisierte Luft entweicht, Fenster, Türen und andere Öffnungen außer für Lüftungszwecke geschlossen halten.

ZUR BEACHTUNG

Bei einem Stromausfall während des Betriebs des Geräts

Wird die Stromversorgung dieses Geräts vorübergehend unterbrochen, setzt das Gerät den Betrieb nach erneuter Stromversorgung automatisch mit denselben Einstellungen wie vor der Unterbrechung der Stromversorgung fort.

Cura e manutenzione



AVVERTIMENTO

1. Per motivi di sicurezza, accertare che il condizionatore d'aria sia spento e che la spina del cavo di alimentazione sia staccata dalla presa di corrente prima di procedere con le operazioni di pulizia.
2. Non versare acqua sull'unità interna per pulirla. Ciò può danneggiare i componenti interni e causare il pericolo di scosse.

Lato presa d'aria e uscita d'aria (unità interna)

Pulire il lato della presa d'aria e dell'uscita d'aria dell'unità interna con una spazzola aspirapolvere o con un panno pulito e morbido.

Rimuovere le eventuali macchie presenti su corpo e griglia dell'unità usando un panno pulito inumidito con un detergente liquido delicato. Nel pulire il lato dell'uscita d'aria, fare attenzione a non spostare le alette forzandole.



PRECAUZIONE

1. Per pulire l'unità interna, non si devono usare solventi o sostanze chimiche aggressive. Non pulire i componenti in plastica con acqua molto calda.
2. Alcuni bordi metallici e le alette sono taglienti e possono causare ferite se maneggiati in modo incorretto. Prestare perciò la dovuta attenzione nel pulire tali parti.
3. La serpentina interna e gli altri componenti dell'unità esterna devono essere puliti una volta all'anno. Rivolgersi al proprio rivenditore o centro di assistenza.

Filtro dell'aria

Il filtro dell'aria raccoglie le particelle di polvere e sporco dall'aria e dovrebbe essere pulito almeno ogni due settimane oppure quando l'indicazione del filtro (■) sul display del telecomando (tipo cablato) non segnala che occorre pulire il filtro. Se il filtro si ostruisce, l'efficienza del condizionatore d'aria ne risulta notevolmente compromessa.

1. Aprire il pannello griglia di aspirazione tirandolo verso di voi.
2. Afferrare il filtro per la linguetta, estrarlo verso l'alto. Eseguire la pulizia del filtro.
3. Quando rimettete il filtro nell'unità accertatevi che la scritta FRONT sia rivolta verso di voi. Inserire il filtro nella propria sede e richiudere il pannello griglia di aspirazione.

PULIZIA FILTRO

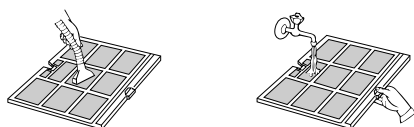

Pulire il filtro con una aspirapolvere. In presenza di polvere oleosa lavate con acqua saponata tiepida, risciacquate e lasciate asciugare.

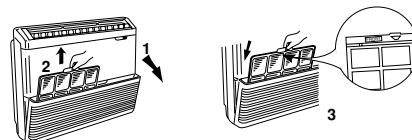

FILTRO ARIA AD ALTA EFFICIENZA (ACCESSORIO FORNITO SU RICHIESTA).

- Il filtro va applicato in aggiunta al filtro standard.
- E' formato da due strati:
 - il primo ha la funzione di filtro ad alta efficienza e trattiene anche le particelle molto piccole presenti nell'aria
 - il secondo strato é formato da un composto di carbone attivo che purifica l'aria dagli odori.

Come applicare l'accessorio.

1. Aprire il pannello griglia di aspirazione ed estrarre il filtro in dotazione dell'unità.
2. Applicare sul lato posteriore del filtro standard le mollette fornite nel kit.
3. Applicare su ogni filtro il relativo set "filtro alta efficienza" che sarà trattenuto dalla molletta.
4. Inserire il doppio filtro nelle relative guide e chiudere il pannello griglia di aspirazione.

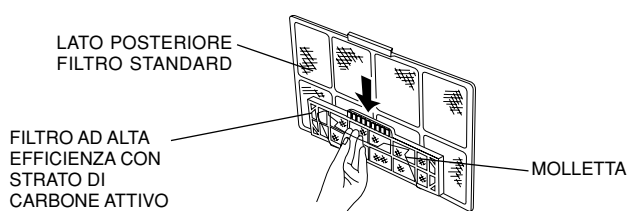

Prima di chiamare il tecnico

Se il condizionatore d'aria non funziona correttamente, prima di chiamare il tecnico per la riparazione controllare quanto segue. Se ciò non consente di eliminare il problema, rivolgersi al proprio rivenditore o centro di assistenza.

Problema	Causa probabile	Rimedio
Il condizionatore d'aria non funziona.	<ol style="list-style-type: none"> 1. Si è verificata una mancanza di corrente. 2. Il salvavita è scattato. 3. La tensione di rete è insufficiente. 4. Il pulsante di accensione/spegnimento è spento. 5. Il telecomando cablato o la pompa di calore non funziona correttamente. (Sullo schermo LCD del telecomando cablato vengono visualizzati il segno di ispezione  e le lettere E, F, H, L, P, in combinazione con dei numeri). 	<ol style="list-style-type: none"> 1. Dopo una mancanza di corrente, premere il pulsante di accensione/spegnimento (ON/OFF) del telecomando cablato. 2. Rivolgersi al centro di assistenza. 3. Rivolgersi ad un elettricista o al proprio rivenditore. 4. Premere nuovamente il pulsante. 5. Rivolgersi al proprio rivenditore.
Il compressore funziona, ma si arresta subito.	<ol style="list-style-type: none"> 1. Presenza di un'ostruzione davanti alla serpentina del condensatore. 	<ol style="list-style-type: none"> 1. Rimuovere l'ostruzione.
Le prestazioni di raffreddamento (o di riscaldamento) sono scarse.	<ol style="list-style-type: none"> 1. Il filtro dell'aria è sporco o intasato. 2. Nella stanza ci sono una fonte di calore o molte persone. 3. Ci sono porte o finestre aperte. 4. C'è un ostacolo vicino alla presa d'aria o all'uscita dell'aria. 5. Il termostato è impostato ad un valore troppo alto per il raffreddamento (o troppo basso per il riscaldamento). 6. (Il sistema di sbrinamento non funziona). 	<ol style="list-style-type: none"> 1. Pulire il filtro dell'aria per migliorare il getto dell'aria. 2. Se possibile, eliminate la fonte di calore. 3. Chiuderle per mantenere il caldo (o il freddo) all'esterno. 4. Rimuoverlo in modo da assicurare un buon getto d'aria. 5. Impostare la temperatura a un livello più basso (o più alto). 6. (Rivolgersi al proprio rivenditore.)

Suggerimenti per risparmiare energia

- Da evitare**
- **Non ostruire la presa d'aria e l'uscita d'aria dell'unità. In caso di ostruzione, l'unità non funziona correttamente e può subire dei danni.**
 - Non lasciar entrare la luce solare diretta nella stanza. A tale scopo utilizzare parasole, tende o persiane. Se le pareti e il soffitto vengono riscaldati dal sole, il raffreddamento della stanza richiede più tempo.

- Cose da fare**
- Mantenete sempre pulito il filtro dell'aria (fare riferimento a "Cura e manutenzione"). Un filtro ostruito compromette il rendimento dell'unità.
 - Per evitare fughe d'aria condizionata, tenete chiuse finestre, porte ed altre aperture.

NOTA

Mancanza di corrente durante il funzionamento dell'unità

In caso di una temporanea mancanza di corrente, l'unità riprende automaticamente a funzionare, al ripristino della corrente, con le stesse impostazioni che aveva prima dell'interruzione.

Cuidados e limpeza



ADVERTÊNCIA

1. Por motivos de segurança desligue o aparelho de ar condicionado e desligue-o também da rede antes de proceder à sua limpeza.
2. Não verta água sobre a unidade interior para a limpar. Poderá danificar os componentes internos e causar descargas eléctricas.

Lado de entrada e saída de ar (unidade interior)

Limpe o lado de entrada e saída de ar da unidade interior com um aspirador ou com um pano macio e limpo.

Se estas partes estiverem muito sujas utilize um pano limpo humedecido em detergente líquido suave. Quando limpar o lado de saída de ar tenha cuidado para não mover as palhetas do seu lugar de instalação.



PRECAUÇÃO

1. Nunca utilize solventes ou produtos químicos fortes para limpar a unidade interior. Não limpe as peças plásticas com água muito quente.
2. Algumas bordas metálicas e as pás do condensador são pontiagudas e podem causar ferimentos se não forem manuseadas com cuidado; tenha especial cuidado ao limpar estas partes.
3. A serpentina interna e outros componentes da unidade exterior devem ser limpos todos os anos. Contacte o seu concessionário ou centro de reparações.

Filtro de ar

O filtro de ar recolhe a poeira e outras partículas do ar. Deve ser limpo aproximadamente cada duas semanas ou quando a indicação de filtro (■) aparece no visor da unidade de controlo remoto (com fios) indicando que o filtro deve ser limpo. Se o filtro ficar bloqueado, a eficiência do ar condicionado diminui bastante.

Como remover o filtro

1. Abrir o painel da grelha de aspiração e puxe-o na vossa direção.
2. Segure o filtro pela extremidade e extraia-o para o alto. Limpe o filtro.
3. Durante a sua reposição, faça atenção que o filtro esteja na posição correta - como no caso anterior.

LIMPEZA DO FILTRO

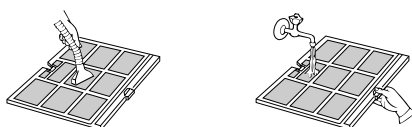

Limpe o filtro com um aspirador do pó. Em caso de poeira oleosa, lave com água morna e sabão. Enxague bem e deixe enxugar.

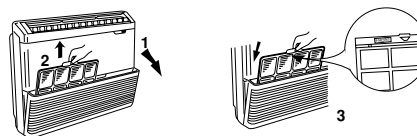

FILTRO DE AR ALTAMENTE EFICIENTE (ACESSÓRIO FORNECIDO SOB ENCOMENDA)

- Este filtro é aplicado sobre o filtro standard.
- É formado por duas camadas:
 - a primeira tem a função de filtro altamente eficiente e retem até as partículas presentes no ar
 - a segunda é formada por composto de carbônio ativo que purifica o ar eliminando cheiros desagradáveis.

Como aplicar este acessório:

1. Abra o painel da grelha de aspiração do ar e extraia o filtro fornecido com a unidade.
2. Aplique no lado posterior do filtro standard o estabilizador fornecido.
3. Aplique em cada filtro standard um filtro de alta eficiência correspondente que será fixado através de um estabilizador.
4. Reponha o filtro duplo no respectivo vão e volte a fechar o painel da grelha de aspiração.

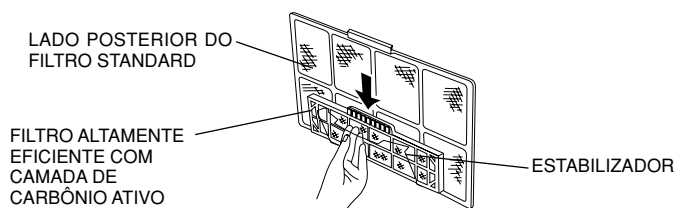

Resolução de problemas

Se o seu aparelho de ar condicionado não funciona correctamente, verifique primeiro os seguintes pontos antes de solicitar assistência. Se não conseguir solucionar o problema, contacte o seu concessionário ou o serviço de assistência.

Avaria	Causa possível	Solução
O aparelho de ar condicionado não funciona de maneira nenhuma.	<ol style="list-style-type: none">1. Falha de alimentação.2. O disjuntor de fugas foi activado.3. Tensão de rede demasiado baixa.4. O botão de operação está desactivado.5. A unidade de controlo remoto com fios ou a bomba de calor não está a funcionar correctamente. (A marca de inspecção  e as letras E, F, H, L, P associadas a números aparecem no LCD da unidade de controlo remoto com fios.)	<ol style="list-style-type: none">1. Após uma falha de corrente eléctrica, pressione o botão de operação ON/OFF na unidade de controlo remoto com fios.2. Contacte o serviço de assistência.3. Consulte um electricista ou o seu concessionário.4. Pressione novamente o botão.5. Consulte o seu concessionário.
O compressor começa a funcionar mas pára pouco depois.	<ol style="list-style-type: none">1. Obstrução em frente da serpentina do compressor.	<ol style="list-style-type: none">1. Retire a obstrução.
Rendimento de arrefecimento (ou aquecimento) deficiente.	<ol style="list-style-type: none">1. Filtro de ar sujo ou obstruído.2. Fonte de calor ou demasiadas pessoas na habitação.3. Portas e/ou janelas abertas.4. Obstáculos perto da entrada ou saída de ar.5. O termóstato está ajustado muito alto para arrefecimento (ou muito baixo para aquecimento).6. (O sistema de descongelação não funciona.)	<ol style="list-style-type: none">1. Limpe o filtro de ar para melhorar a circulação do ar.2. Elimine a fonte de calor se for possível.3. Feche-as para evitar a entrada de calor (ou frio).4. Retire os obstáculos para assegurar uma boa circulação de ar.5. Coloque a temperatura mais baixa (ou mais alta).6. (Consulte o seu concessionário.)

Sugestões para poupar energia

- Evite**
- **Bloquear a entrada e saída de ar do aparelho. Se estiverem obstruídas, o aparelho não funcionará adequadamente e poderá ficar danificado.**
 - Deixar a luz solar incidir directamente na sala. Use cortinas, venezianas, etc. Se as paredes e o tecto da habitação forem aquecidos pelo sol levará mais tempo para arrefecer a habitação.
- Faça**
- Procure manter o filtro de ar sempre limpo. (Consulte “Cuidados e limpeza”.) Um filtro obstruído prejudica o rendimento do aparelho.
 - Para evitar a saída do ar condicionado, mantenha janelas, portas e outras aberturas fechadas.

NOTA

Se ocorrer uma falha de energia com a unidade a funcionar

Se a corrente eléctrica for cortada temporariamente, a unidade retoma a operação automaticamente após a reposição da corrente eléctrica utilizando os mesmos ajustes programados.

Φροντίδα και καθάρισμα



ΠΡΟΕΙΔΟΠΟΙΗΣΗ

1. Για λόγους ασφαλείας, πριν από το καθάρισμα, πρέπει να σβήνετε τη συσκευή κλιματισμού και βγάξετε το ηλεκτρικό καλώδιο από την πρίζα.
2. Μη ρίχνετε νερό στην εσωτερική μονάδα για να την καθαρίσετε. Αυτό θα προκαλέσει βλάβη στα εσωτερικά μέρη και κίνδυνο ηλεκτροπληξίας.

Πλευρά εισόδου και εξόδου αέρα (εσωτερική μονάδα)

Καθαρίστε την πλευρά εισόδου και εξόδου αέρα της εσωτερικής μονάδας με ηλεκτρική σκούπα με βούρτσα ή σκουπίστε τις πλευρές με ένα καθαρό και μαλακό πανί.

Αν αυτά τα μέρη είναι βρόμικα, χρησιμοποιήστε ένα καθαρό πανί βρεγμένο με ένα ήπιο υγρό απορρυπαντικό. Όταν καθαρίζετε την πλευρά εξόδου αέρα, προσέξτε να μη βγάλετε τα πτερύγια από τη θέση τους.



ΠΡΟΣΟΧΗ

1. Ποτέ μη χρησιμοποιείτε διαλύτες ή ισχυρές χημικές ουσίες για τον καθαρισμό της εσωτερικής μονάδας. Μη σκουπίζετε τα πλαστικά μέρη χρησιμοποιώντας πολύ ζεστό νερό.
2. Μερικές μεταλλικές μύτες καθώς και τα πτερύγια είναι πολύ αιχμηρά και μπορεί να προκαλέσουν τραυματισμό αν ο χειρισμός τους δεν είναι σωστός. Να είστε ιδιαίτερα προσεκτικοί όταν καθαρίζετε αυτά τα μέρη.
3. Το εσωτερικό πηνίο και άλλα τμήματα της εξωτερικής μονάδας πρέπει να καθαρίζονται κάθε χρόνο. Συμβουλευθείτε τον προμηθευτή σας ή το κέντρο εξυπηρέτησης.

Φίλτρο αέρα

Το φίλτρο αέρα συγκρατεί τη σκόνη και άλλα σωματίδια που βρίσκονται στον αέρα και θα πρέπει να το καθαρίζετε σε τακτά χρονικά διαστήματα όπως υποδεικνύεται στον παρακάτω πίνακα ή όταν η ένδειξη του φίλτρου (■) στο τηλεχειριστήριο (τύπος με καλώδιο) δείχνει ότι το φίλτρο χρειάζεται καθάρισμα. Αν το φίλτρο φραχτεί, η απόδοση του κλιματιστικού μειώνεται σημαντικά.

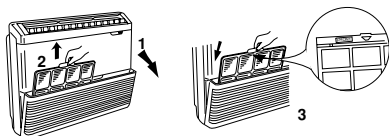

Τύπος	ΚΡΑΦΡ
Περίοδο	Δύο εβδομάδες

Πώς να αφαιρέσετε το φίλτρο

1. Ανοίξετε την γρίλια απορρόφησης και τραβήξτε την προς το μέρος σας.
2. Πιάστε το φίλτρο από την γλωσσίτα και τραβήξτε το προς τα επάνω. Καθαρίστε το φίλτρο.
3. Όταν βάζετε το φίλτρο στην μονάδα προσέχετε ώστε η λέξη FRONT να είναι προς το μέρος σας. Τοποθετήστε το φίλτρο στην θέση του και ξανακλείστε την γρίλια απορρόφησης αέρος.

ΠΙΣΩ ΠΛΕΥΡΑ
ΦΙΛΤΡΟΥ ΣΤΑΝΤΑΡ

ΦΙΛΤΡΟ ΥΨΗΛΗΣ
ΙΚΑΝΟΤΗΤΑΣ
ΜΕ ΣΤΡΩΜΑ
ΕΝΕΡΓΟΥ ΑΝΘΡΑΚΑ

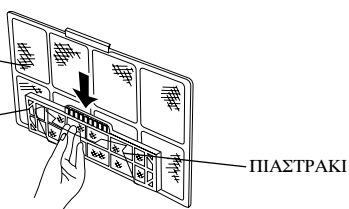

ΚΑΘΑΡΙΣΜΟΣ ΦΙΛΤΡΟΥ

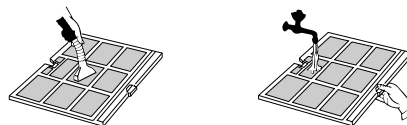

Χρησιμοποιήστε ηλεκτρική σκούπα για να καθαρίσετε τις ελαφρές σκόνες. Αν υπάρχει καθολου κολλώδης σκόνη στο φίλτρο πλύνετε το μέσα σε χλιαρό νερό με σαπουνάδα και ξεβγάλετε το

ΦΙΛΤΡΟ ΑΕΡΟΣ ΥΨΗΛΗΣ ΙΚΑΝΟΤΗΤΑΣ (ΕΞΑΡΤΗΜΑ ΠΑΡΕΧΟΜΕΝΟ ΚΑΤΟΠΙΝ ΠΑΡΑΓΓΕΛΙΑΣ)

- Το φίλτρο τοποθετείται επάνω στο φίλτρο στάνταρ.
- Αποτελείται από δύο στρώματα:
 - το πρώτο λειτουργεί σαν προ-φιλτράρισμα υψηλής ικανότητας και κατακρατά ακόμη και τα πολύ μικρά μόρια σκόνης που κυκλοφορούν στον αέρα.
 - το δεύτερο στρώμα αποτελείται από μία ανθρακική ένωση που καθαρίζει τον αέρα που περιέχει διάφορες οσμές.

Πώς θα τοποθετήσετε το εξάρτημα.

1. Ανοίξτε την γρίλια απορρόφησης αέρος και βγάλτε το φίλτρο που περιλαμβάνεται στην μονάδα.
2. Εφαρμόστε στην πίσω πλευρά του φίλτρου στάνταρ τα πιαστράκια που θα βρείτε στο κιτ.
3. Εφαρμόστε επάνω σε κάθε φίλτρο το αντίστοιχο σετ "φίλτρο υψηλής ικανότητας" το οποίο συγκρατείται με το πιαστράκι που αναφέρθηκε παραπάνω.
4. Περάστε το διπλό φίλτρο στους αντίστοιχους οδηγούς και κλείστε την γρίλια απορρόφησης.

Αντιμετώπιση προβλημάτων

Αν το κλιματιστικό σας δεν λειτουργεί σωστά, ελέγξτε πρώτα τα ακόλουθα σημεία πριν ζητήσετε κάποια εργασία επισκευής. Αν η συσκευή συνεχίζει να μη λειτουργεί σωστά, ειδοποιήστε τον προμηθευτή σας ή το κέντρο εξυπηρέτησης.

Πρόβλημα	Πιθανή αιτία	Λύση
Το κλιματιστικό δεν λειτουργεί καθόλου.	<ol style="list-style-type: none">Έχει συμβεί διακοπή ηλεκτρικού ρεύματος.Αποσυνδέθηκε ο διακόπτης ηλεκτρικής διαρροής.Η τάση του ηλεκτρικού ρεύματος είναι πολύ χαμηλή.Το κουμπί λειτουργίας βρίσκεται στην ανενεργή θέση.Το τηλεχειριστήριο με καλώδιο ή η αντλία θέρμανσης δεν λειτουργεί σωστά. (Στην οθόνη του τηλεχειριστηρίου με καλώδιο εμφανίζεται η ένδειξη επιθεώρησης \triangle και τα γράμματα E, F, H, L, P μαζί με αριθμούς).	<ol style="list-style-type: none">Μετά από διακοπή ρεύματος, πιέστε το κουμπί λειτουργίας ON/OFF στο τηλεχειριστήριο με καλώδιο.Επικοινωνήστε με το κέντρο εξυπηρέτησης.Συμβουλευτείτε έναν ηλεκτρολόγο ή τον προμηθευτή σας.Πατήστε ξανά το κουμπί.Συμβουλευτείτε τον προμηθευτή.
Ο συμπιεστής λειτουργεί αλλά σταματά μετά από σύντομο χρονικό διάστημα.	<ol style="list-style-type: none">Υπάρχει εμπόδιο μπροστά από το πηνίο του συμπυκνωτή.	<ol style="list-style-type: none">Απομακρύνετε το εμπόδιο.
Ανεπαρκής απόδοση ψύξης (ή θέρμανσης).	<ol style="list-style-type: none">Το φίλτρο αέρα είναι βρόμικο ή φραγμένο.Υπάρχει πηγή θερμότητας ή πολύς κόσμος στο δωμάτιο.Οι πόρτες ή/και τα παράθυρα είναι ανοιχτά.Υπάρχει εμπόδιο κοντά στην είσοδο ή στην έξοδο του αέρα.Ο θερμοστάτης είναι ρυθμισμένος πολύ υψηλά για ψύξη (ή πολύ χαμηλά για θέρμανση).(Το σύστημα απόψυξης δε λειτουργεί).	<ol style="list-style-type: none">Καθαρίστε το φίλτρο αέρα για τη βελτίωση της ροής του αέρα.Αν είναι δυνατόν απομακρύνετε την πηγή θερμότητας.Κλείστε τις πόρτες και τα παράθυρα για να απομονώσετε τη θερμότητα (ή το κρύο) έξω.Αφαιρέστε το για να εξασφαλίσετε την καλή ροή του αέρα.Ρυθμίστε τη θερμοκρασία σε μια χαμηλότερη (ή υψηλότερη) τιμή.(Συμβουλευτείτε τον προμηθευτή).

Υποδείξεις για εξοικονόμηση ενέργειας

- Αποφύγετε**
- Μην εμποδίζετε την είσοδο και την έξοδο αέρα της συσκευής. Αν αυτές εμποδίζονται, η συσκευή δε θα λειτουργεί σωστά και μπορεί να προκληθεί βλάβη.
 - Μην αφήνετε το ηλιακό φως να μπαίνει απευθείας στο δωμάτιο. Χρησιμοποιήστε αλεξήλια, περσίδες ή κουρτίνες. Αν οι τοίχοι και το ταβάνι του δωματίου θερμανθούν από τον ήλιο, θα απαιτηθεί περισσότερος χρόνος για την ψύξη του δωματίου.
- Τι να κάνετε**
- Το φίλτρο αέρα πρέπει να είναι πάντα καθαρό. (Ανατρέξτε στην παράγραφο «Φροντίδα και καθάρισμα».) Ένα φραγμένο φίλτρο θα μειώσει την απόδοση της συσκευής.
 - Εμποδίζετε τη διαφυγή του κλιματισμένου αέρα διατηρώντας παράθυρα, πόρτες και κάθε είδους ανοίγματα κλειστά.

ΠΑΡΑΤΗΡΗΣΗ

Σε περίπτωση διακοπής ρεύματος ενώ λειτουργεί η μονάδα

Αν η ηλεκτρική παροχή της συσκευής διακοπεί προσωρινά, μόλις επανέλθει το ηλεκτρικό ρεύμα, θα επαναφερθεί αυτόματα η λειτουργία της συσκευής με τις ίδιες ρυθμίσεις που υπήρχαν πριν τη διακοπή.

Cuidados y limpieza



ADVERTENCIA

1. Por motivos de seguridad, asegúrese de apagar el acondicionador de aire, y desconectarlo también de la red eléctrica antes de realizar su limpieza.
2. No vierta agua sobre la unidad interior para limpiarla. El agua podría estropear los componentes internos y producir una descarga eléctrica.

Lados de entrada y salida de aire (Unidad interior)

Limpie los lados de entrada y salida de aire de la unidad interior con el cepillo de una aspiradora, o límpielos con un paño limpio y suave.

Si estas partes están muy sucias, utilice un paño limpio humedecido en líquido detergente suave. Cuando limpie el lado de salida de aire, tenga cuidado de no sacar las aspas de su sitio.



PRECAUCIÓN

1. No utilice nunca disolventes o productos químicos ásperos cuando limpie la unidad interior. No limpie las partes de plástico con agua muy caliente.
2. Algunos bordes metálicos y las aletas, al ser puntiagudos, pueden causar heridas si no se manejan con cuidado. Tenga mucho cuidado al limpiar estas piezas.
3. El serpentín interno y otros componentes de la unidad exterior deberán limpiarse todos los años. Póngase en contacto con su concesionario o centro de reparaciones.

Filtro de aire

El filtro de aire recoge polvo y otras partículas del aire y deberá ser limpiado al menos cada dos semanas o cuando la indicación de filtro (■) del visualizador de la unidad del mando a distancia (tipo alámbrica) muestre que el filtro necesita ser limpiado. Si se bloquea el filtro, la eficacia del acondicionador de aire disminuirá enormemente.

Cómo extraer el filtro

1. Abrir la puerta de la rejilla de aspiración tirando hacia sí.
2. Coger el filtro por la lengüeta y sacarlo tirando hacia arriba. Limpiar el filtro del aire.
3. Al volver a colocar el filtro en el aparato comprobar que la palabra FRONT esté hacia usted. Introducir el filtro y cerrar la puerta de la rejilla de aspiración.

LIMPIEZA DEL FILTRO

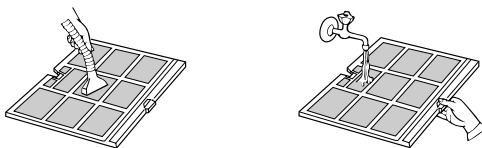

Elimine el polvo fino con un aspirador. Si se ha adherido suciedad al filtro, lávelo con agua templada jabonosa, aclárelo después y séquelo.

FILTRO DEL AIRE DE ALTA EFICACIA (MODELOS FTR) (ACCESORIO SUMINISTRADO BAJO PEDIDO).

- Este filtro se añade al filtro estándar.
- Está formado por dos capas:
 - la primera tiene la función de filtro de alta eficacia y retiene hasta las partículas más pequeñas del aire.
 - la segunda capa está formada por un compuesto de carbón activo que purifica el aire de olores.

Cómo se aplica el accesorio.

1. Abrir la puerta de la rejilla de aspiración y extraer el filtro estándar del aparato.
2. Poner en el lado posterior del filtro standard las pinzas suministradas en la caja de montaje.
3. Ponerle a cada filtro su relativo "filtro de alta eficacia" y sujetarlo con la pinza.
4. Introducir los dobles filtros en sus guías y cerrar la puerta de la rejilla de aspiración.

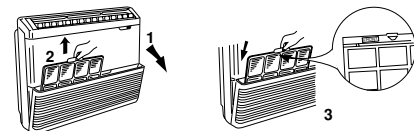

LADO POSTERIOR
FILTRO ESTANDAR

FILTRO DE ALTA
EFICACIA CON
CAPA DE CARBON
ACTIVO

PINZA

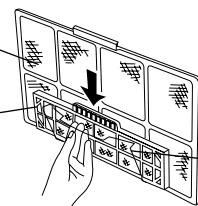

Localización de averías

Si su acondicionador de aire no funciona correctamente, compruebe primero la lista de abajo antes de llamar al servicio de reparaciones. Si no puede solucionar el problema, póngase en contacto con su concesionario o centro de reparaciones.

Avería	Causa posible	Remedio
El acondicionador de aire no funciona en absoluto.	<ol style="list-style-type: none"> 1. Corte de alimentación eléctrica. 2. Ha saltado el ruptor de fugas. 3. La tensión de la línea es demasiado baja. 4. El botón de operación está desactivado. 5. La unidad de mando a distancia alámbrica o la bomba de calor está funcionando mal. (En el LCD de la unidad de mando a distancia alámbrica aparece la marca de inspección  y las letras E, F, H, L, P en combinación con números.) 	<ol style="list-style-type: none"> 1. Después de una interrupción del suministro eléctrico, pulse el botón de operación ON/OFF en la unidad de mando a distancia alámbrica. 2. Póngase en contacto con el centro de reparaciones. 3. Póngase en contacto con un electricista o con su concesionario. 4. Pulse el botón otra vez. 5. Consulte a su distribuidor.
El compresor se pone en funcionamiento pero se para pronto.	<ol style="list-style-type: none"> 1. Obstrucción delante del serpentín del condensador. 	<ol style="list-style-type: none"> 1. Retire la obstrucción.
Mal enfriamiento (o calefacción).	<ol style="list-style-type: none"> 1. Filtro de aire sucio u obstruido. 2. Fuente de calor o muchas personas en la sala. 3. Puertas y/o ventanas abiertas. 4. Obstáculos cerca de la entrada o salida de aire. 5. El termostato está ajustado demasiado alto para enfriamiento (o demasiado bajo para calefacción). 6. (El sistema de descongelación no funciona.) 	<ol style="list-style-type: none"> 1. Limpie el filtro de aire para mejorar la circulación del aire. 2. Elimine la fuente de calor si fuese posible. 3. Cierrelas para que no entre el calor (o el frío). 4. Quite los obstáculos para asegurar una buena circulación del aire. 5. Fije una temperatura más baja (o más alta). 6. (Consulte a su distribuidor.)

Sugerencias para ahorrar energía

- Evite**
- **No bloquee la entrada y salida de aire de la unidad. Si cualquiera de ellas está obstruida, la unidad no funcionará bien, y podrá dañarse.**
 - No deje que entre luz solar directa en la habitación. Utilice parasoles, persianas o cortinas. Si el sol calienta las paredes y el techo de la sala, se tardará más tiempo en enfriarla.
- Sí**
- Mantenga siempre limpio el filtro de aire. (Refer to “Cuidados y limpieza”.) Un filtro obstruido reducirá el rendimiento de la unidad.
 - Para evitar que escape el aire acondicionado, cierre las ventanas, las puertas y otras aberturas.

NOTA

Si ocurre un corte del suministro eléctrico mientras está funcionando la unidad

Si el suministro eléctrico de esta unidad se interrumpe temporalmente, la unidad reanudará automáticamente la operación una vez restablecido el suministro utilizando los mismos ajustes que los de antes de cortarse el suministro eléctrico.



In order to carry on a constant improvement, our products can be modified without prior notice.
Per garantire un costante miglioramento dei nostri prodotti, ci riserviamo di modificarli senza preavviso.
Par souci d'amélioration constante, nos produits peuvent être modifiés sans préavis.
Unsere Produkte werden laufend verbessert und können Vorankündigung abgeändert Werden.
En el interés de mejoras constantes, nuestros productos pueden modificarse sin aviso previo.

R.D. 28 Reyrieux BP 131 - 01601 Trévoux CEDEX France
Tél. 04.74.00.92.92 - Fax 04.74.00.42.00
R.C.S. Bourg-en-Bresse B 759 200 728