

TECHNICAL DATA & SERVICE MANUAL

**INDOOR UNIT: MCW1B5XAB
MCW2B5XAB
MCW3B5XAB
MCW4B5XAB**

**MPW1B5XAA
MPW2B5XAA
MPW3B5XAA
MPW4B5XAA**

SPLIT SYSTEM AIR CONDITIONER

Model No.	Product Code No.
MCW1B5XAB	38.7104.026
MCW2B5XAB	38.7104.027
MCW3B5XAB	38.7104.028
MCW4B5XAB	38.7104.029
MPW1B5XAA	38.7104.040
MPW2B5XAA	38.7104.043
MPW3B5XAA	38.7104.045
MPW4B5XAA	38.7104.047

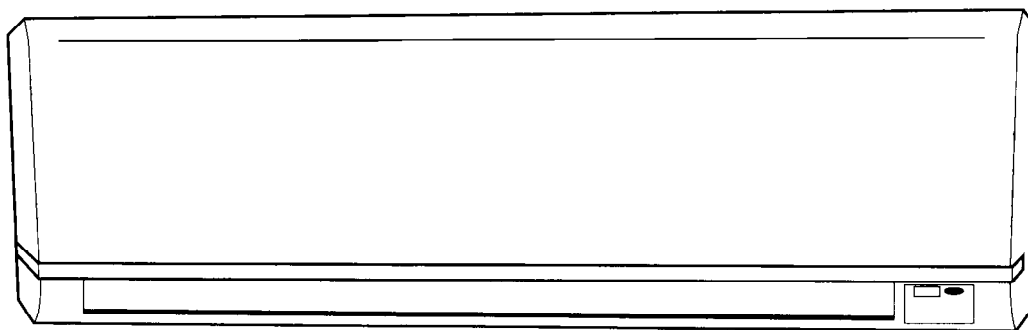

Table of Contents

	Page
1. SPECIFICATIONS	3
1-1 Unit specifications	3
1-2 Major Component specifications	7
1-3 Other Component specifications	11
2. DIMENSIONAL DATA	12
3. ELECTRICAL DATA	13
3-1 Electric Wiring Diagrams	13
3-2 Jumpers Configuration	14
3-3 Contacts for Building Automation	16
3-4 Maintenance	17
4. FUNCTION	18
4-1 Cool Mode Operation	18
4-2 Heat Mode Operation	19
4-3 Auto (cool/heat) Mode Operation	20
4-4 Dry Mode Operation	21
4-5 Fan Mode Operation	21
4-6 Auto Fan Speed	21
4-7 Forced Mode	22
4-8 Protection Operation in Heat Mode	22
4-9 I Feel Function	24
4-10 Night Function	24
4-11 Diagnostic	25
5. CHECKING ELETRICAL COMPONENTS	26
5-1 Measurement of Insulation Resistance	26
5-2 Checking Continuity of Fuse on PCB Ass'y	27

1. SPECIFICATIONS

1-1 Unit Specifications

MCW1B5XAB

MPW1B5XAA

Power source	230 V - 50 Hz
---------------------	---------------

Performance			
Input		kW	0,020
Running Amps		A	0,11
Total cooling capacity (1)	High/Med./Low	kW	1,24/---/0,8
Sensible cooling capacity (1)	High/Med./Low	kW	0,94/---/0,58
Heating capacity (2)	High/Med./Low	kW	1,72/---/1,11
Air circulation	High/Med./Low	m ³ /h	220/---/150

Features			
Controls/Temperature controls			Microprocessor/ I.C. thermostat
Control unit			Wireless remote control unit
Timer			ON/OFF 24 hours
Fan speed			3 and Auto
Airflow direction	Horizontal		Manual
	Vertical		Auto
Water FLOW in cooling	High/Med./Low	l/h	215/---/135
Pressure drop on water in cooling (1)	High/Med./Low	kPa	16,1/---/5,8
Pressure drop on water in heating (2)	High	kPa	15,3
Air Filter			Washable, polypropylene, class HB (UL94)
Power noise level	High/Med./Low	dB-A	41/--/32
Water tubing connections			1/2" gas female
Air clean filter			Optional
3-Way valve + By-pass (1/2 gas male, KVS 1,6, 230 NC)			Optional

Dimensions & Weight				
MCW	Package dimensions	Height	mm	322
		Width	mm	855
		Depth	mm	233
	Shipping volume		m ³	0,064
MPW	Package dimensions	Height	mm	322
		Width	mm	855
		Depth	mm	273
	Shipping volume		m ³	0,075
Weight	Net		kg	8.0
	Shipping		kg	11,0

DATA SUBJECT TO CHANGE WITHOUT NOTICE

- (1) Air inlet 27°C (D.B.) / 19°C (W.B.); Water inlet 7°C; Water outlet 12°C
 (2) Air inlet 20°C; Water inlet 50°C (same water capacity as in conditions (1))

OPERATION LIMITS

Min. water inlet temperature 4°C

Max. water inlet temperature 60°C

Max. operating pressure of hydraulic circuit 16 bar

Min. air recirculation temperature 5°C

Max. air recirculation temperature 32°C

MCW2B5XAB**MPW2B5XAA**

Power source	230 V - 50 Hz
---------------------	---------------

Performance			
Input		kW	0,020
Running Amps		A	0,11
Total cooling capacity (1)	High/Med./Low	kW	1,67/---/0,96
Sensible cooling capacity (1)	High/Med./Low	kW	1,30/---/0,74
Heating capacity (2)	High/Med./Low	kW	2,38/---/1,49
Air circulation	High/Med./Low	m ³ /h	270/---/180

Features			
Controls/Temperature controls			Microprocessor/ I.C. thermostat
Control unit			Wireless remote control unit
Timer			ON/OFF 24 hours
Fan speed			3 and Auto
Airflow direction	Horizontal		Manual
	Vertical		Auto
Water capacity in cooling	High/Med./Low	l/h	290/---/165
Pressure drop on water in cooling (1)	High/Med./Low	kPa	27,2/---/9,7
Pressure drop on water in heating (2)	High	kPa	26,2
Air Filter			Washable, polypropylene, class HB (UL94)
Power noise level	High/Med./Low	dB-A	45/--/35
Water tubing connections			1/2" gas female
Air clean filter			Optional
3-Way valve + By-pass (1/2 gas male, KVS 1,6, 230 NC)			Optional

Dimensions & Weight				
MCW	Package dimensions	Height	mm	322
		Width	mm	855
		Depth	mm	233
	Shipping volume		m ³	0,064
MPW	Package dimensions	Height	mm	322
		Width	mm	855
		Depth	mm	273
	Shipping volume		m ³	0,075
Weight	Net		kg	8,0
	Shipping		kg	11,0

DATA SUBJECT TO CHANGE WITHOUT NOTICE

- (1) Air inlet 27°C (D.B.) / 19°C (W.B.); Water inlet 7°C; Water outlet 12°C
(2) Air inlet 20°C; Water inlet 50°C (same water capacity as in conditions (1))

OPERATION LIMITS

Min. water inlet temperature 4°C

Max. water inlet temperature 60°C

Max. operating pressure of hydraulic circuit 16 bar

Min. air recirculation temperature 5°C

Max. air recirculation temperature 32°C

MCW3B5XAB**MPW3B5XAA**

Power source	230 V - 50 Hz
---------------------	---------------

Performance			
Input		kW	0,075
Running Amps		A	0,35
Total cooling capacity (1)	High/Med./Low	kW	3,17/2,53/1,91
Sensible cooling capacity (1)	High/Med./Low	kW	2,56/1,89/1,53
Heating capacity (2)	High/Med./Low	kW	4,50/3,50/2,70
Air circulation	High/Med./Low	m ³ /h	510/400/320

Features			
Controls/Temperature controls		Microprocessor/ I.C. thermostat	
Control unit		Wireless remote control unit	
Timer		ON/OFF 24 hours	
Fan speed		3 and Auto	
Airflow direction		Horizontal	Manual
		Vertical	Auto
Water capacity in cooling	High/Med./Low	l/h	545/435/330
Pressure drop on water in cooling (1)	High/Med./Low	kPa	20/13/7
Pressure drop on water in heating (2)	High	kPa	19
Air Filter		Washable, polypropylene, class HB (UL94)	
Power noise level	High/Med./Low	dB-A	58/52/46
Water tubing connections		1/2" gas female	
Air clean filter		Optional	
3-Way valve + By-pass (1/2 gas male, KVS 1,6, 230 NC)		Optional	

Dimensions & Weight				
MCW	Package dimensions	Height	mm	347
		Width	mm	1065
		Depth	mm	260
	Shipping volume		m ³	0,096
MPW	Package dimensions	Height	mm	347
		Width	mm	1065
		Depth	mm	281
	Shipping volume		m ³	0,104
Weight		Net	kg	11,0
		Shipping	kg	14,0

DATA SUBJECT TO CHANGE WITHOUT NOTICE

- (1) Air inlet 27°C (D.B.) / 19°C (W.B.); Water inlet 7°C; Water outlet 12°C
 (2) Air inlet 20°C; Water inlet 50°C (same water capacity as in conditions (1))

OPERATION LIMITS

Min. water inlet temperature 4°C

Max. water inlet temperature 60°C

Max. operating pressure of hydraulic circuit 16 bar

Min. air recirculation temperature 5°C

Max. air recirculation temperature 32°C

MCW4B5XAB**MPW4B5XAA**

Power source	230 V - 50 Hz
---------------------	---------------

Performance			
Input		kW	0,080
Running Amps		A	0,40
Total cooling capacity (1)	High/Med./Low	kW	3,67/3,14/2,62
Sensible cooling capacity (1)	High/Med./Low	kW	3,01/2,50/2,12
Heating capacity (2)	High/Med./Low	kW	5,50/4,50/3,70
Air circulation	High/Med./Low	m ³ /h	710/580/470

Features			
Controls/Temperature controls		Microprocessor/ I.C. thermostat	
Control unit		Wireless remote control unit	
Timer		ON/OFF 24 hours	
Fan speed		3 and Auto	
Airflow direction		Horizontal	Manual
		Vertical	Auto
Water capacity in cooling	High/Med./Low	l/h	630/540/450
Pressure drop on water in cooling (1)	High/Med./Low	kPa	27/20/14
Pressure drop on water in heating (2)	High	kPa	26,0
Air Filter		Washable, polypropylene, class HB (UL94)	
Power noise level	High/Med./Low	dB-A	59/53/48
Water tubing connections		1/2" gas female	
Air clean filter		Optional	
3-Way valve + By-pass (1/2 gas male, KVS 1,6, 230 NC)		Optional	

Dimensions & Weight			
Package dimensions MCW	Height	mm	347
	Width	mm	1065
	Depth	mm	260
Shipping volume		m ³	0,096
Package dimensions MPW	Height	mm	347
	Width	mm	1065
	Depth	mm	281
Shipping volume		m ³	0,104
Weight	Net	kg	11,0
	Shipping	kg	14,0

DATA SUBJECT TO CHANGE WITHOUT NOTICE

(1) Air inlet 27°C (D.B.) / 19°C (W.B.); Water inlet 7°C; Water outlet 12°C

(2) Air inlet 20°C; Water inlet 50°C (same water capacity as in conditions (1))

OPERATION LIMITS

Min. water inlet temperature 4°C

Max. water inlet temperature 60°C

Max. operating pressure of hydraulic circuit 16 bar

Min. air recirculation temperature 5°C

Max. air recirculation temperature 32°C

1-2 Major Component Specifications

MCW1B5XAB

MPW1B5XAA

Controller PCB	
Part No.	SAC ON-OFF IDU
Controls	Microprocessor
Control circuit fuse	250 V - 3,15 A
Jumper setting JP1..JP5	2,54mm-5pcs

Remote Control Unit	SAC W-REM
---------------------	-----------

Fan & Fan Motor	
Type	Cross - flow
Q'ty Dia. and length	1.... Ø 97 / L 617
Fan motor model...Q'ty	KFV4Q-11H5P-S...1
No. Of poles...rpm (230 V - 50 Hz, Hi)	4...1160
Nominal output	10
Coil resistance (Ambient temp. 20 °C)	BRN-WHT: 561,8 VLT-WHT: 197,4 VLT-ORG: 63,4 YEL-ORG: 155,7 YEL-PNK: 115,9
Safety devices	Type internal fuse
Operating temp. Open	°C 145 ± 5
Close	-
Run capacitor	µF 0,6
	VAC 440

Flap Motor	
Type	Stepping motor
Model	MP24Z1
Rating	DC 12 V
Coil resistance (Ambient temp. 25 °C)	Ω 380 ± 7%

Heat Exch. Coil	
Coil	Aluminium plate fin / Copper tube
Rows	2
Fin pitch	mm 1,4
Face area	m ² 0,095
Quantity of water	l 0,30

DATA SUBJECT TO CHANGE WITHOUT NOTICE

MCW2B5XAB**MPW2B5XAA**

Controller PCB	
Part No.	SAC ON-OFF IDU
Controls	Microprocessor
Control circuit fuse	250 V - 3,15 A
Jumper setting JP1...JP5	2,54mm-5pcs

Remote Control Unit	SAC W-REM
----------------------------	-----------

Fan & Fan Motor	
Type	Cross - flow
Q'ty Dia. and length	mm 1.... Ø 97 / L 617
Fan motor model...Q'ty	KFV4Q-11H5P-S...1
No. Of poles...rpm (230 V, Hi)	4...1160
Nominal output	W 10
Coil resistance (Ambient temp. 20 °C)	Ω BRN-WHT: 561,8 VLT-WHT: 197,4 VLT-ORG: 63,4 YEL-ORG: 155,7 YEL-PNK: 115,9
Safety devices	Type internal fuse
Operating temp. Open	°C 145 ± 5
Close	-
Run capacitor	μF 1
	VAC 430

Flap Motor	
Type	Stepping motor
Model	MP24Z1
Rating	DC 12 V
Coil resistance (Ambient temp. 25 °C)	Ω 380 ± 7%

Heat Exch. Coil	
Coil	Aluminium plate fin / Copper tube
Rows	2
Fin pitch	mm 1,4
Face area	m ² 0,115
Quantity of water	l 0,39

DATA SUBJECT TO CHANGE WITHOUT NOTICE

MCW3B5XAB**MPW3B5XAA**

Controller PCB	
Part No.	SAC ON-OFF IDU
Controls	Microprocessor
Control circuit fuse	250 V - 3,15 A
Jumper setting JP1..JP5	2,54mm-5pcs

Remote Control Unit	SAC W-REM
----------------------------	-----------

Fan & Fan Motor	
Type	Cross - flow
Q'ty Dia. and length	mm
Fan motor model...Q'ty	UF2Q-21SB5P...1
No. Of poles...rpm (230 V, Hi/Me/Lo)	2... 1550/1250/1025
Nominal output	W
Coil resistance (Ambient temp. 20 °C)	Ω
	BRN-WHT: 163,7
	VLT-WHT: 68,84
	VLT-ORG: 33,16
	YEL-ORG: 73,55
	YEL-PNK: 43,72
Safety devices	Type
	Operating temp. Open °C
	Close
Run capacitor	μ F
	VAC
	termal protector
	130 \pm 8
	79 \pm 15
	0,8
	440

Flap Motor	
Type	Stepping motor
Model	MP24Z2
Rating	DC 12 V
Coil resistance (Ambient temp. 25 °C)	Ω
	400 \pm 7%

Heat Exch. Coil	
Coil	Aluminium plate fin / Copper tube
Rows	2
Fin pitch	mm
Face area	m ²
Quantity of water	l
	1,4
	0,156
	0,80

DATA SUBJECT TO CHANGE WITHOUT NOTICE

MCW4B5XAB**MPW4B5XAA**

Controller PCB	
Part No.	SAC ON-OFF IDU
Controls	Microprocessor
Control circuit fuse	250 V - 3,15 A
Jumper setting JP1..JP5	2,54mm-5pcs

Remote Control Unit	SAC W-REM
----------------------------	-----------

Fan & Fan Motor	
Type	Cross - flow
Q'ty Dia. and length	mm 1... Ø 90,5 / L 746
Fan motor model...Q'ty	UF2Q-21SB5P...1
No. Of poles...rpm (230 V, Hi/Me/Lo)	2... 1550/1250/1025
Nominal output	W 24,07
Coil resistance (Ambient temp. 20 °C)	Ω BRN-WHT: 163,7 VLT-WHT: 68,84 VLT-ORG: 33,16 YEL-ORG: 73,55 YEL-PNK: 43,72
Safety devices	Type thermal protector
Operating temp. Open	°C 130 ± 8
Close	79 ± 15
Run capacitor	μF 1,5
	VAC 440

Flap Motor	
Type	Stepping motor
Model	MP24Z2
Rating	DC 12 V
Coil resistance (Ambient temp. 25 °C)	Ω 400 ± 7%

Heat Exch. Coil	
Coil	Aluminium plate fin / Copper tube
Rows	2
Fin pitch	mm 1,4
Face area	m ² 0,156
Quantity of water	l 0,80

DATA SUBJECT TO CHANGE WITHOUT NOTICE

1-3 Other Component Specifications

Trasformer (TR)		A040C5026AA
Rating	Primary Secondary Capacity	AC 230 V, 50 Hz 13 V - 5VA
Coil resistance	Ω (at 25°C)	Primary: - Secondary: -
Thermal cut-off temp.		120°C

Thermistor (Coil sensor)		NTC-THERMISTOR
Resistance	k Ω	10 at 25 °C

Thermistor (Room sensor)		NTC-THERMISTOR
Resistance	k Ω	10 at 25 °C

2. DIMENSIONAL DATA

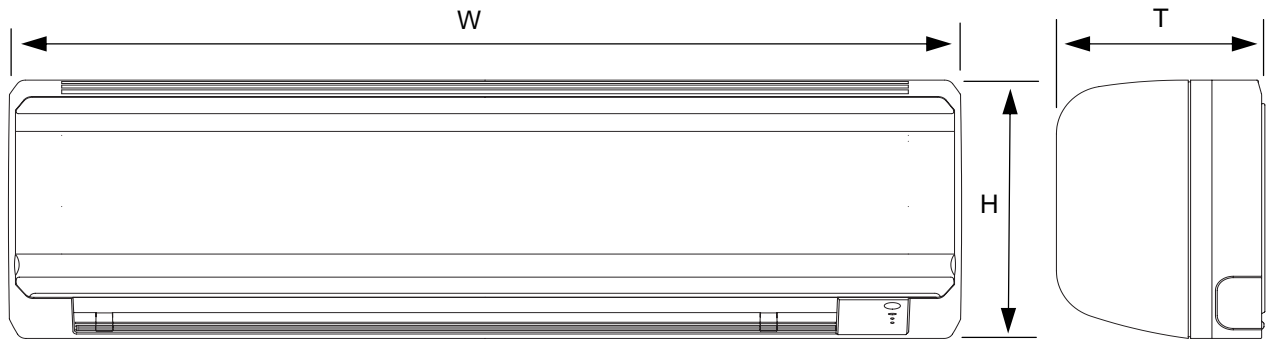

REAR VIEW

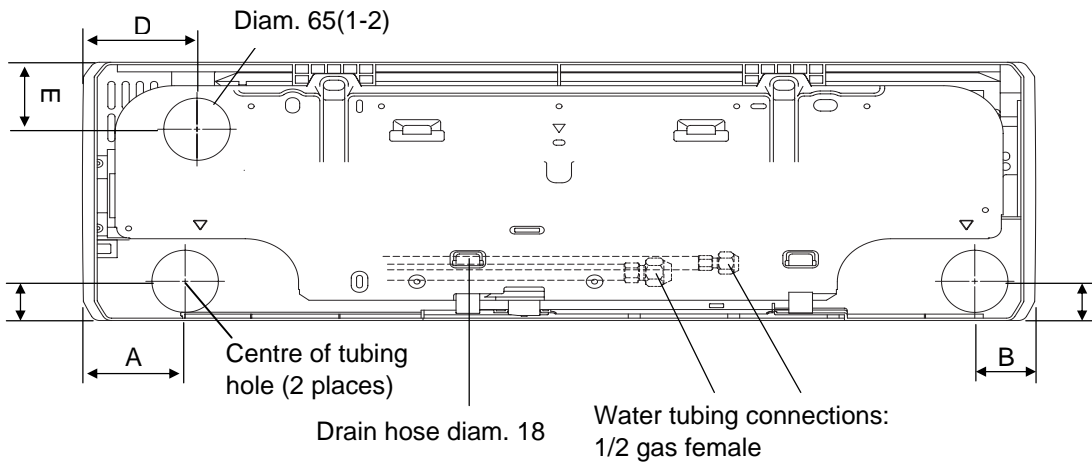

Dimensions			MCW 1	MCW 3	MPW 1	MPW 3
			MCW 2	MCW 4	MPW 2	MPW 4
W	mm		805	995	805	995
H	mm		270	285	270	285
T	mm		181	206	215	240

		MCW 1-2	MCW 3-4
		MPW 1-2	MPW 3-4
A	mm	99,5	147,5
B	mm	58,5	147,5
C	mm	41	45
D	mm	111	-
E	mm	70	-

3. ELECTRICAL DATA

3-1 Electric Wiring Diagrams

MCW1B5XAB

MCW2B5XAB

MPW1B5XAA

MPW2B5XAA

ELECTRIC WIRING DIAGRAM

37-3159-235-01

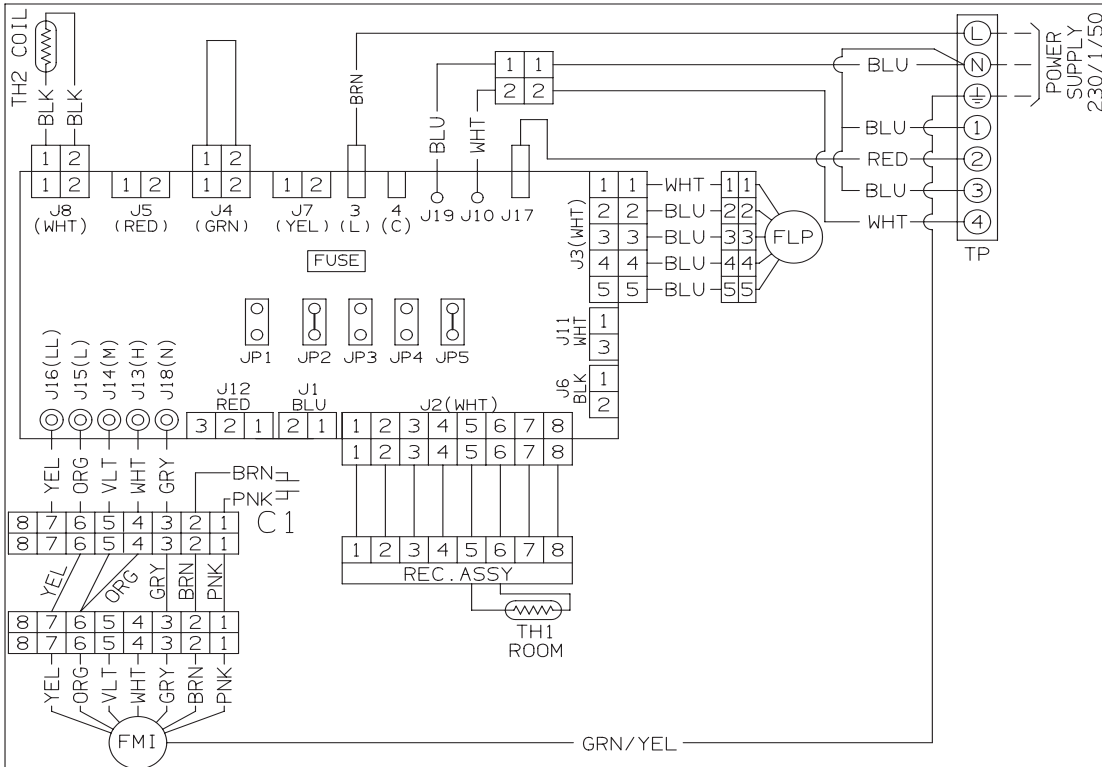

MCW3B5XAB

MCW4B5XAB

MPW3B5XAA

MPW4B5XAA

ELECTRIC WIRING DIAGRAM

37-3159-236-01

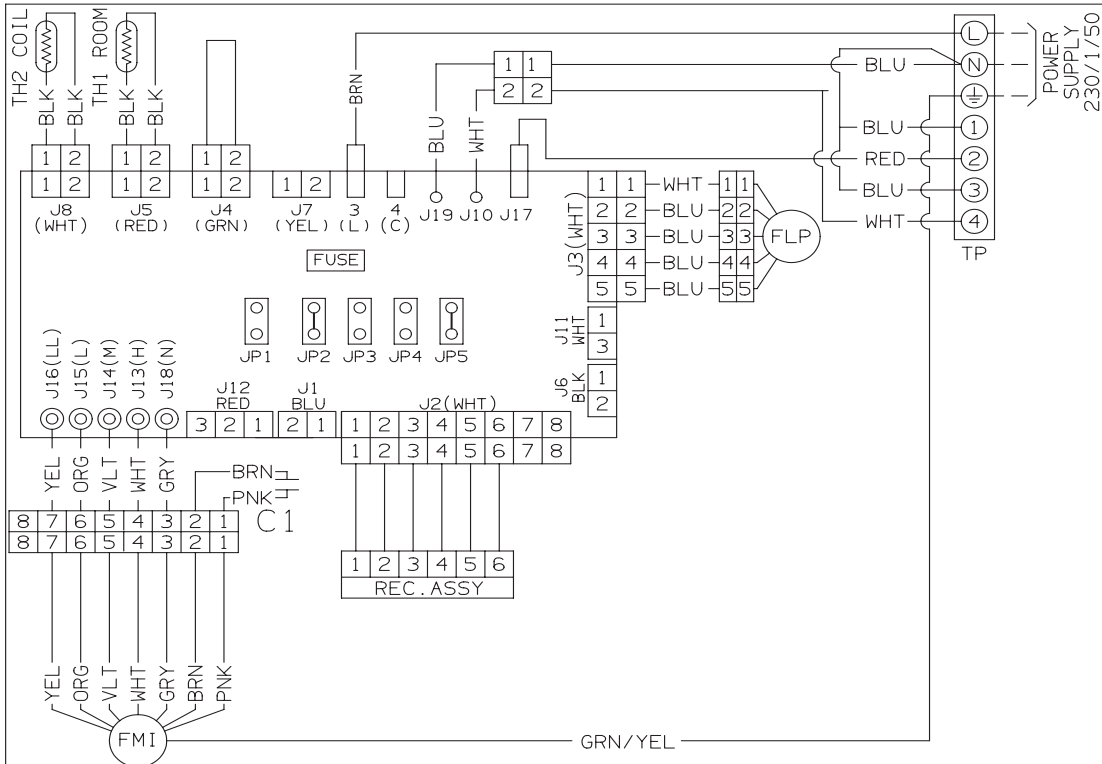

3-2 JUMPERS CONFIGURATION

Jumpers are located on the indoor PCB near the MODE button.

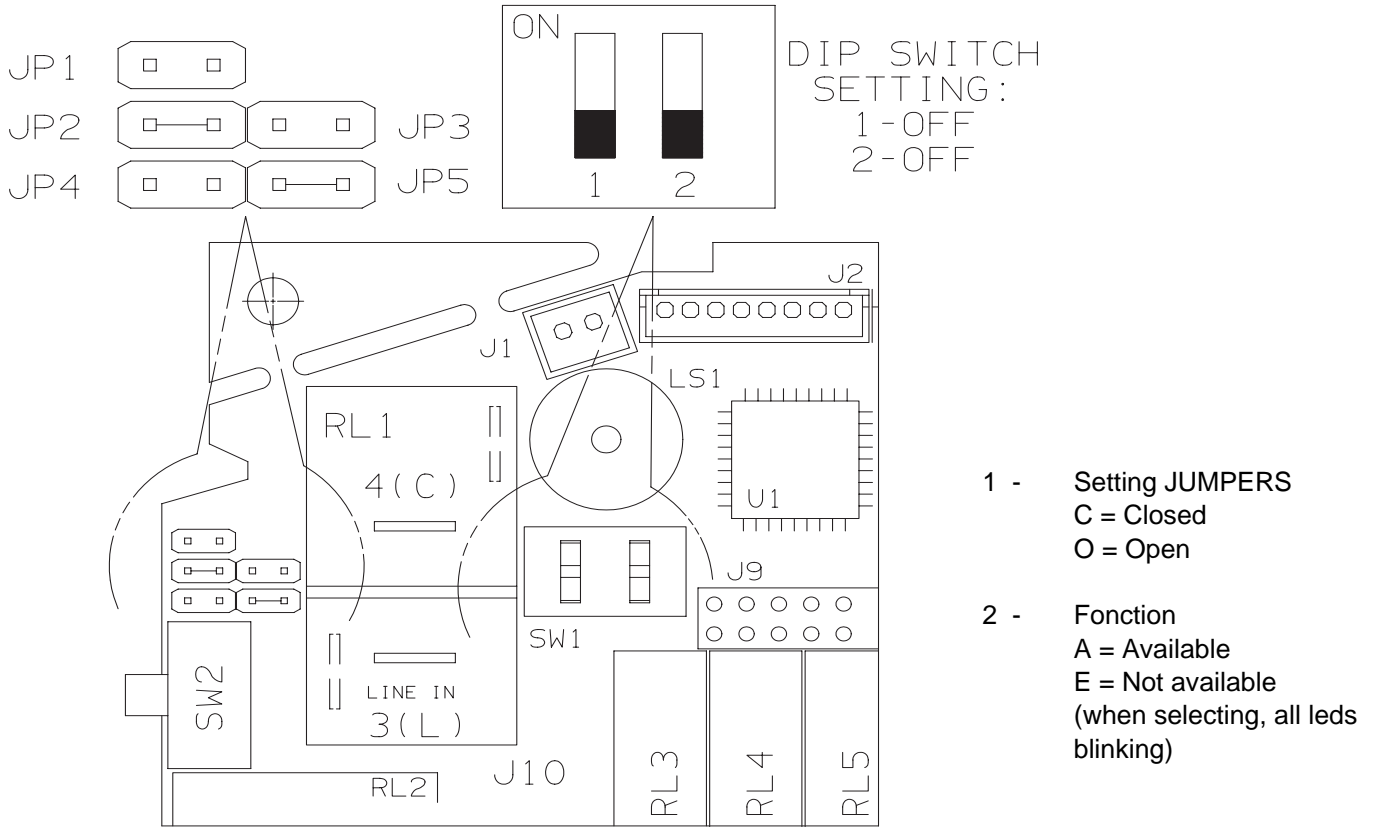





NOTE: settings different from the factory one must be done by special worker





FACTORY SYSTEM CONFIGURATION: COOLING ONLY WITH VALVE

COOLING ONLY SYSTEM	FUNCTIONS					JUMPERS				
					FAN ONLY	JP1	JP2	JP3	JP4	JP5
	A	E	E	A	A	O	C	O	O	C





SYSTEM CONFIGURATION:COOLING OR HEATING WITH VALVE

COOLING ONLY SYSTEM	FUNCTIONS					JUMPERS				
					FAN ONLY	JP 1	JP2	JP3	JP4	JP5
	A	A	E	A	A	0	0	0	0	C

SYSTEM CONFIGURATION:HEATING ONLY WITH VALVE

COOLING ONLY SYSTEM	FUNCTIONS					JUMPERS				
					FAN ONLY	JP 1	JP2	JP3	JP4	JP5
	E	A	E	E	A	0	0	0	0	0

SYSTEM CONFIGURATION:COOLING WITH VALVE OR HEATING WITH VALVE

COOLING ONLY SYSTEM	FUNCTIONS					JUMPERS				
					FAN ONLY	JP 1	JP2	JP3	JP4	JP5
	A	A	A	A	A	0	0	0	0	C

3-3 CONTACTS FOR BUILDING AUTOMATION

3-3.1 INPUT CONTACT (J4 - green)

The status of this input affects system operation according to the following:

- Contact OPEN : system does not operate (always OFF) – inputs from wireless remote controller are not processed
- Contact CLOSED: system operates in the normal way according to the inputs coming from wireless remote controller

3-3.2 OUTPUT CONTACT (J12)

This connector is directly tied to the contact (normally open) of a power relay which activates every time the following alarm condition occur:

- RAT damaged
- ICT damaged

In this case when alarm happens, on poles 1 and 3 of J12 connector, 220 VAC-50Hz are available.
Max electrical load: **1A- 240VAC**

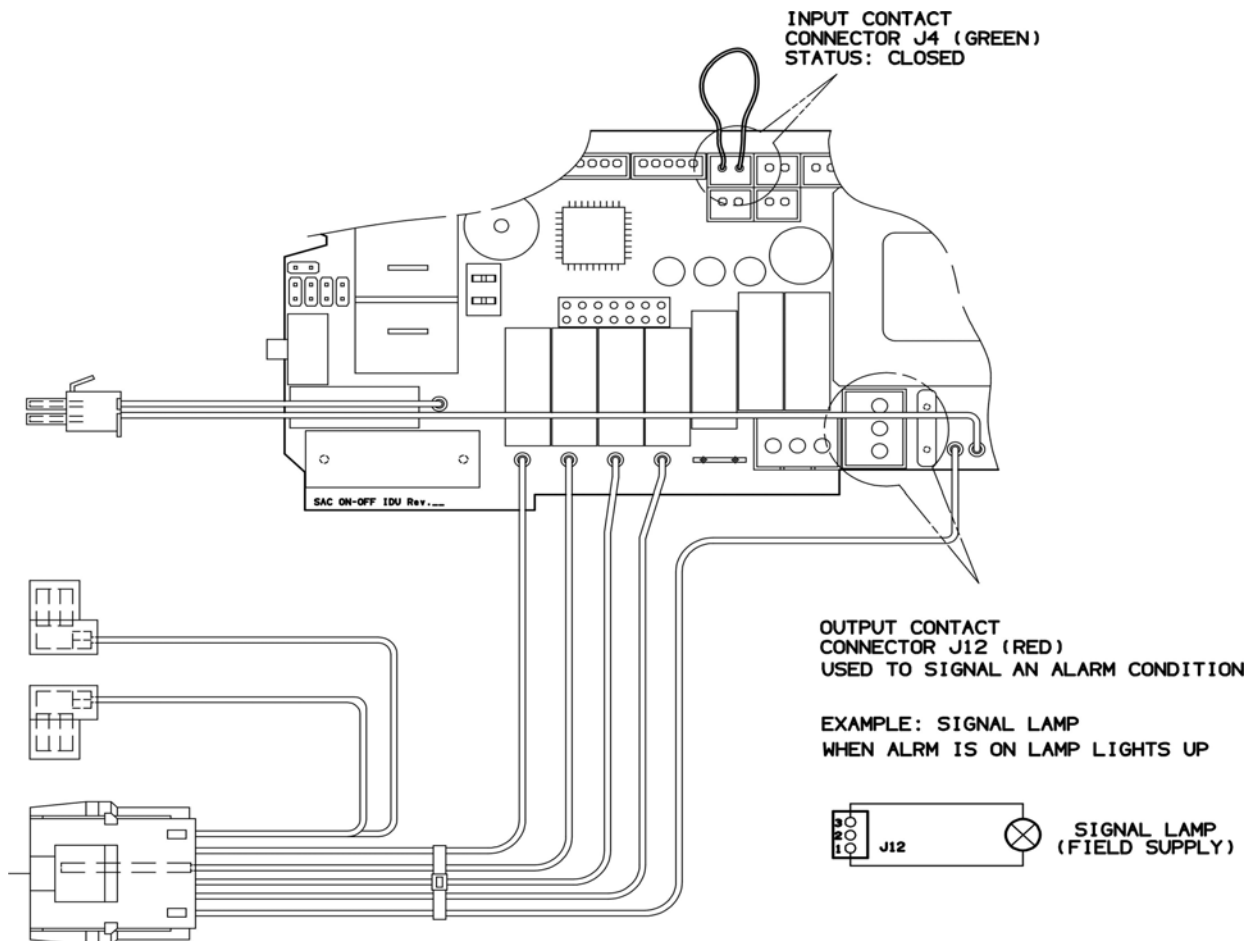

3-4 MAINTENANCE

Changing the Address of the Air Conditioner

In case of more than one air conditioner operating in the same room, it may be necessary to assign an address to each unit in order to avoid operation conflicts. Address is set acting on the dip-switches located on the indoor PCB and on the remote controller. The PCB settings must match the corresponding ones on the wireless remote controller.

How to change address of the air conditioner

Dip switch is located on the indoor PCB near the buzzer.
Set the PCB to the address desired

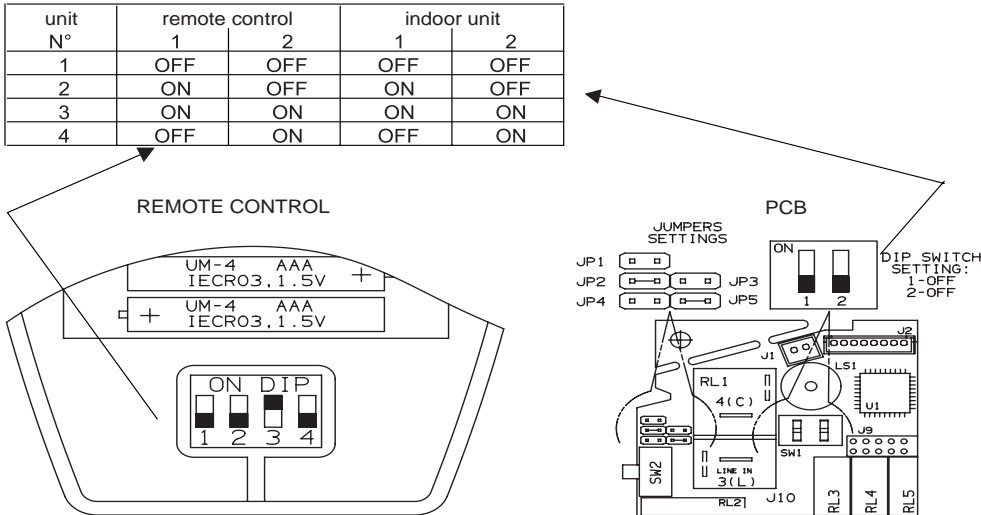

As default switches SW1 and SW2 are in off status (PCB factory state).

How to change address on Remote Control Unit

Dip switch is located on the battery compartment.

- 1) Pull out the door and remove the batteries.
- 2) Set the switch SW1 and SW2 according to the indoor PCB settings (do not act on SW3 and SW4)
- 3) Insert the batteries and pull on the door

As default switches SW1 and SW2 are in off status (remote controller factory state).

4.FUNCTION

4-1 Cool Mode Operation

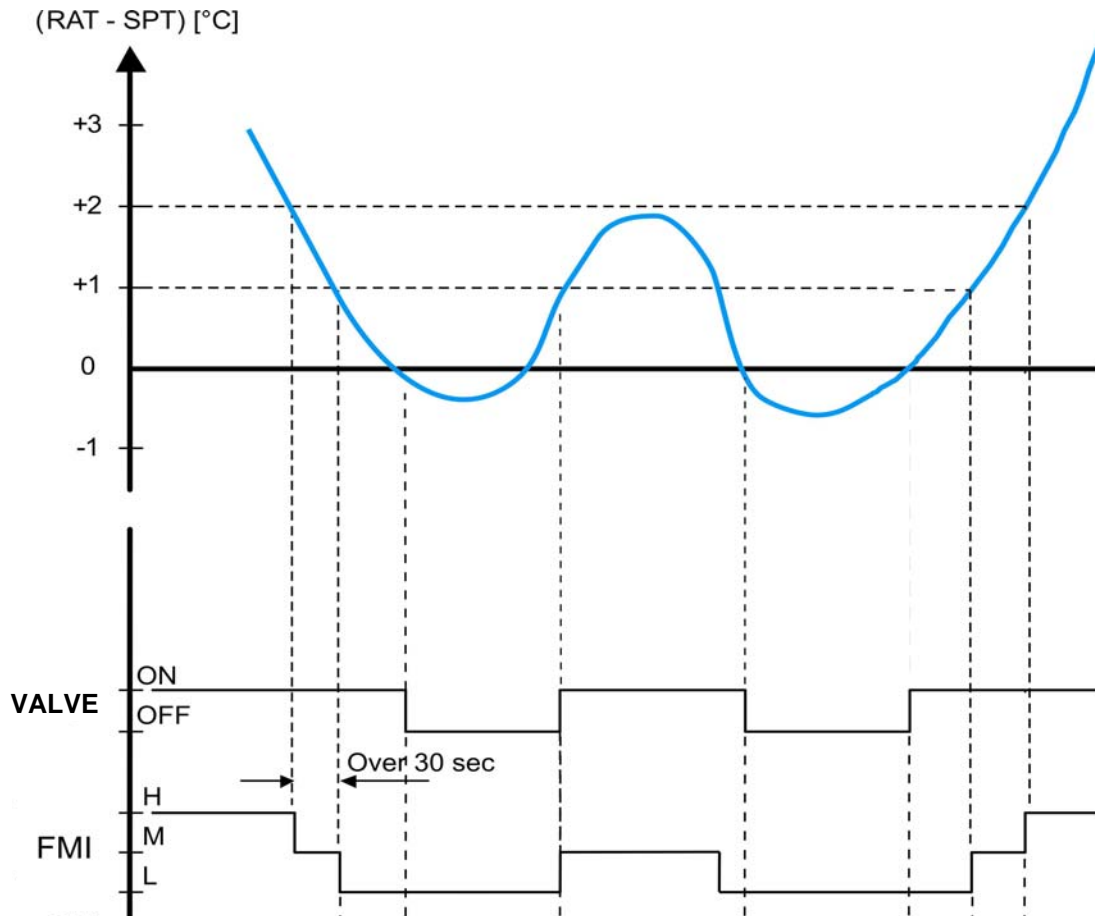

NOTES

1. In this graph, the FMI is operating with the "Auto Fan Speed" setting. If the user has selected the Low, Medium or High fan speed, the FMI will run at that speed only.

2. The indoor fan can change speed only after it has operated at the same speed for 30 sec if in AUTO and 1 sec for the other settings (High, Med, Low).

4-2 Heat Mode Operation

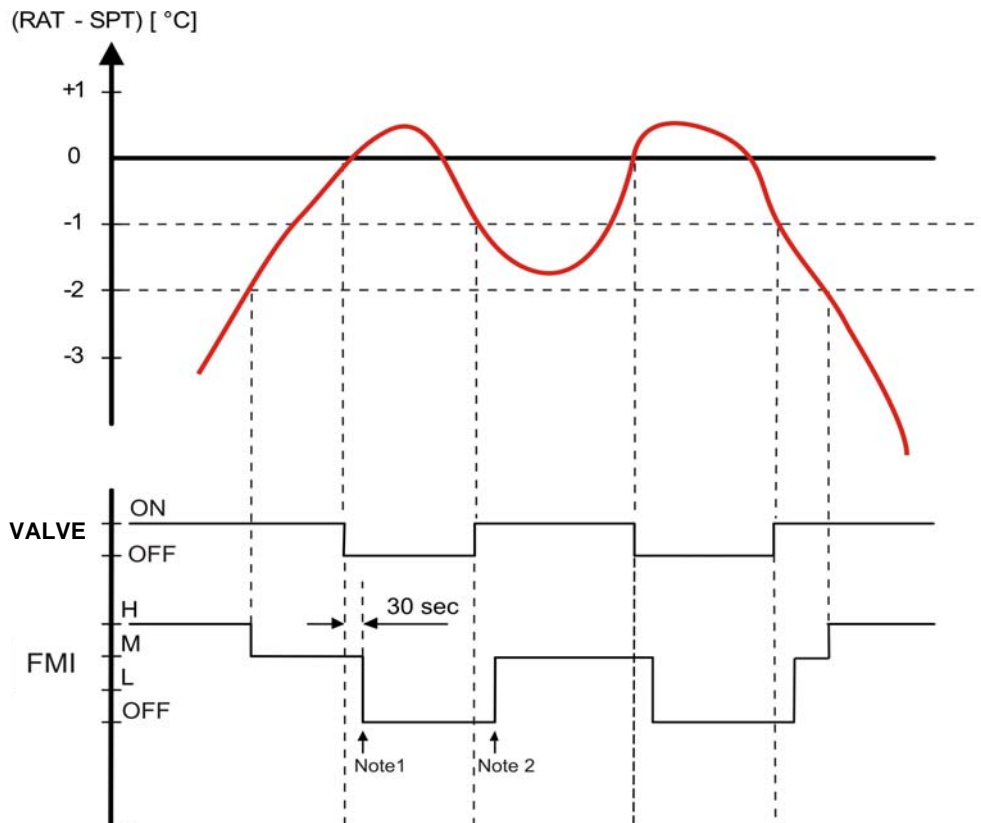

The Heating mode operation is similar to the Cooling mode operation. The VALVE and FMI are mainly controlled by the value of $(RAT - SPT)$. In the graph above, the FMI is operating in AUTO speed mode. Therefore, the FMI speed changes automatically according to the $(RT - SPT)$.

NOTES

1. After VALVE is switched off, the FMI runs for 30s in order to purge heat from the indoor coil.
2. The FMI will not be turned on until the indoor coil temperature is warm enough to prevent the supply of cool air (see COLD DRAFT PREVENTION mode for details). The indoor fan can change speed only after it has operated at the same speed for 30 sec if in AUTO and 1 sec for the other settings (High, Med, Low).

4-3 Auto (cool/heat) Mode Operation

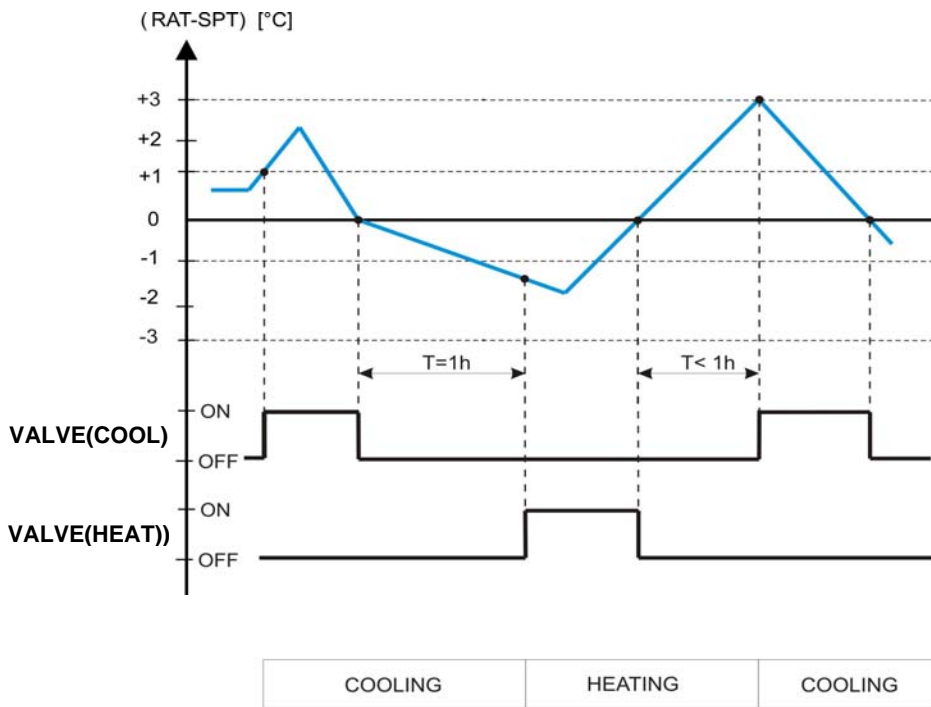

In Auto Mode, the unit switches automatically between the Auto Cooling and Auto Heating in order to maintain the room temperature (RAT) at the prescribed set point (SPT). The switching between the two modes is according to the above graph. Refer to the sections 5.1 COOLING MODE and 5.2 HEATING MODE for system operation details.

4-4 Dry Mode Operation

Dry operation remove moisture from indoor air running, in cooling mode, at a low level without reducing the ambient temperature. This is done cycling ON and OFF indoor and outdoor units according to below.

ROOM TEMP	DRY LEVEL	JP4 OPEN	JP4 CLOSED
$\geq \text{SPT}+2^{\circ}\text{C}$	LEVEL 0	Operation according to COOLING mode	Operation according to COOLING mode
$< \text{SPT}+2^{\circ}\text{C}$ $\geq \text{SPT}-1^{\circ}\text{C}$	LEVEL 1	CM off	CM off
		FMO on	FMO off
		FMI runs at LOW speed RV off	FMI runs at LOW speed RV off
$< \text{SPT}-1^{\circ}\text{C}$ $\geq 15^{\circ}\text{C}$	LEVEL 2	CM off	CM off
		FMO switches 3 minutes on and 9 minutes off	FMO off
		FMI switches LL and L during FMO operation RV off	FMI switches LL and L (3 MIN. on and 9 OFF) RV off
$< 15^{\circ}\text{C}$	DRY OFF ZONE	CM off	CM off
		FMO off	FMO off
		FMI off	FMI off
		RV off	RV off

SPT = Set Point Temperature

4-5 Fan Mode Operation

With this mode, the indoor fan is turned on while cooling and heating valve stay off all the time. The user can select between 3 speeds: HIGH, MEDIUM and LOW.

4-6 Auto Fan speed

With this option selected, the indoor fan speed changes automatically according to the difference between the detected air temperature (RAT sensor) and the set point (SPT):

COOLING MODE

$2 \leq (\text{RAT} - \text{SPT})$:	HIGH speed
$1 \leq (\text{RAT} - \text{SPT}) < 2$:	MEDIUM speed
$(\text{RAT} - \text{SPT}) < 1$:	LOW speed

HEATING MODE

$2 \leq (\text{SPT} - \text{RAT})$:	HIGH speed
$(\text{SPT} - \text{RAT}) < 2$:	MEDIUM speed

NOTE

SPT = Set Point Temperature

4-7 Forced Mode

In this mode the system operates (COOLING or HEATING mode – fixed settings) or is switched off by means of the MODE button of the indoor unit control board. The operation modes can be selected pressing the button in a cyclic way (OFF ⇒ COOL ⇒ HEAT ⇒ OFF...). The settings are:

COOLING mode

SET POINT temperature = 25°C
FAN SPEED = HIGH

HEATING mode

SET POINT temperature = 21°C
FAN SPEED = HIGH

4-8 Protection operations in Heat Mode

5-8.1 Cold draft

This feature prevents the supply of cold air forcing the indoor fan to a speed which cannot be changed by the user. As soon as the protection mode is exited speed can be changed manually through the remote controller. The protection acts in the following

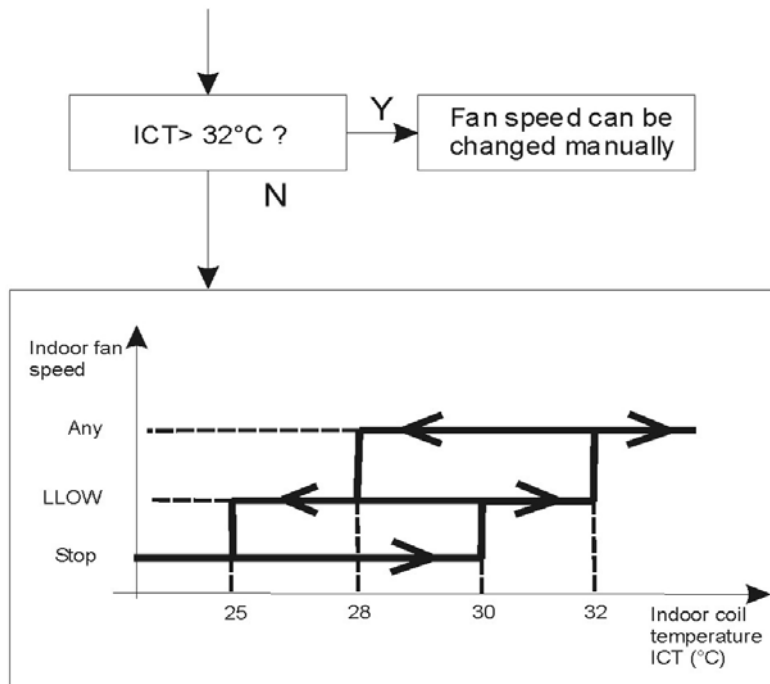

4-8.2 Overheat

This feature prevents the build up of high pressure in the indoor heat exchanger during heating operation

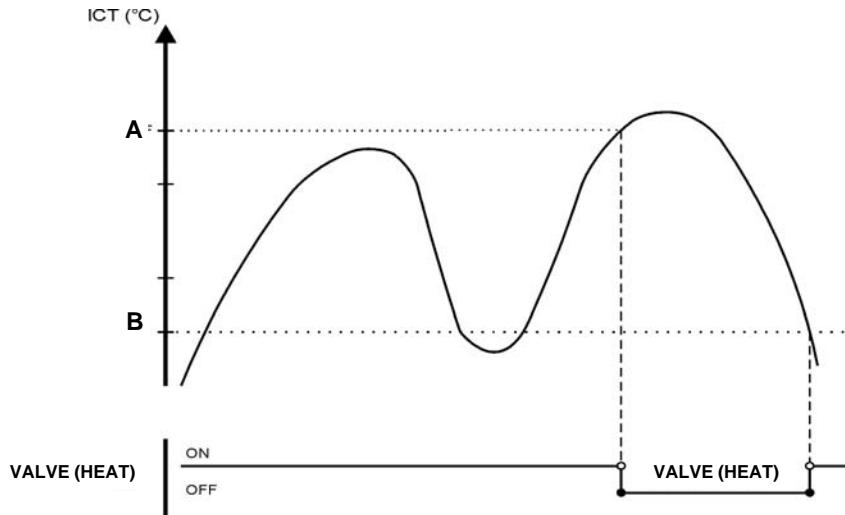

A (°C)	65
B (°C)	55

4-9 I FEEL Function

As standard configuration the air conditioner operates detecting the room temperature through the sensor equipped in the wireless remote controller (icon I FEEL shown on the display). This feature provides a personalised environment since the temperature can be detected where the remote controller is located. It is possible to de-activate this option pressing the I FEEL button on the remote controller. In this case the I FEEL icon is no longer displayed and room temperature is detected through the sensor included in the indoor unit.

4-10 NIGHT Function

When this function is active, room temperature changes automatically to compensate for body temperature variations while sleeping. After 10 hours of operation system switches automatically to OFF state. This mode of operation is available both in COOLING and HEATING mode.

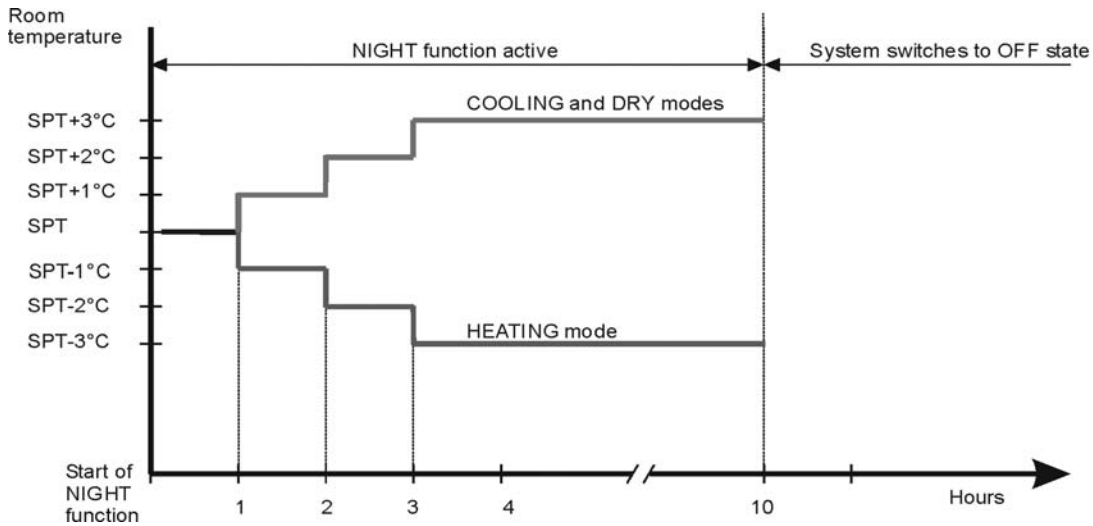

4-11 Diagnostic

With this feature is possible to have a visual signal that a trouble is occurring.
This mode is always active and the signalling is made through the display board LEDS .
In case of no troubles the LEDS status follows its normal function.

NOTES

- The troubles are showed according a priority list that is in case of more than one trouble present, is always showed, at first, the one with the highest priority (1 ⇒ 2⇒ 3 etc).
- Sensor damaged means a situation where sensor is short-circuited or opened.
- In case of damaged sensors, the system (CM, FMO, FMI etc), if in OFF state, does not start.

Priority	TROUBLE	LEDS status			Effects
		LD1(stby)	LD2(opr)	LD3(timer)	
2	RAT damaged	F	O	O	System does not operate
3	ICT damaged	F	F	O	
4	WRONG MODE SELECTED	F	F	F	System does not operate

O = LED off

● = LED on

F = LED blinking

WARNING: Priority 4 only for COOLING

5 CHECKING ELECTRICAL COMPONENTS

5-1 Measurement of Insulation Resistance

The insulation is in good condition if the resistance exceeds 1 MOhm

a) Power Supply Wires

Clamp the earthed wire of the power supply wires with the lead clip of the insulation resistance tester and measure the resistance by placing a probe on either of the power wires (fig.1).

Then measure the resistance between the earthed wire and the other power wires (fig.1).

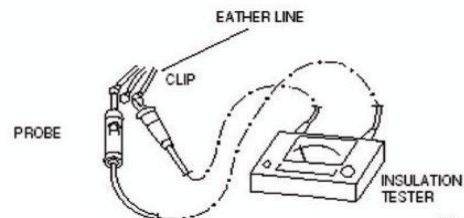

Fig. 1

b) Unit

Clamp an alluminium plate fin or copper tube with the lead clip of the insulation resistance tester and measure the resistance by placing a probe on N terminal, and then on Lterminal the terminal plate (fig.2)

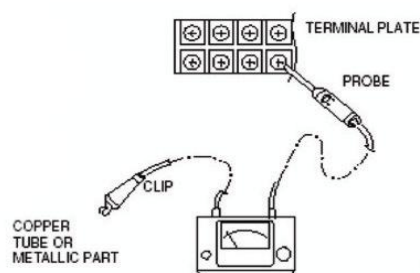

Fig. 2

c) Measurement of Insulation Resistance for Electrical Parts

Disconnect the lead wires of the disired electric part from terminal plate, PCB assy, capacitor, etc. Similary disconnect the connector. Then measure the insulation resistance (fig.1 to 4).

Refer to electric wiring diagram.

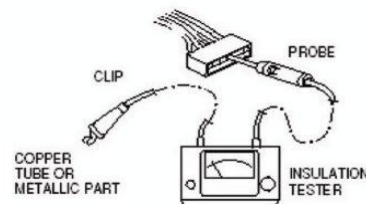

Fig. 3

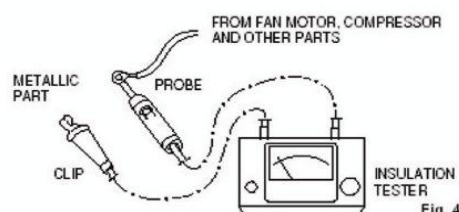

Fig. 4

NOTE

If the probe cannot enter the poles because the hole is too narrow then use a probe with a thinner pin.

5-2 Checking Continuity of fuse on PCB assy

Remove PCB assy from electrical component box (fig.5)

Then pull out the fuse from PCB assy

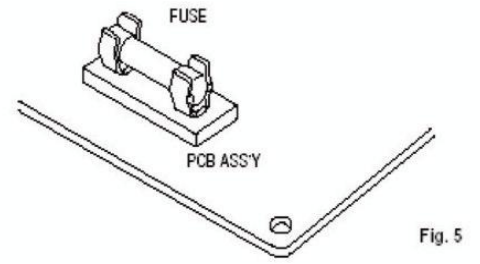

Check continuity of fuse by the multimeter (fig.6)

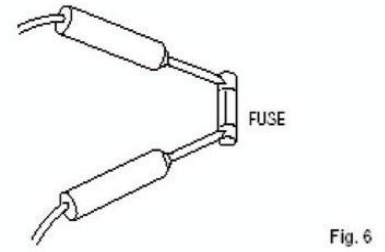



R.D. 28 Reyrieux BP 131 - 01601 Trévoux CEDEX France
Tél. 04.74.00.92.92 - Fax 04.74.00.42.00
R.C.S. Bourg-en-Bresse B 759 200 728