

TECHNICAL DATA & SERVICE MANUAL



**INDOOR UNIT: MTA8FIA0R5IAA
MTA8FBIA0R5IAA**

SPLIT SYSTEM AIR CONDITIONER

Model No.	Product Code No.
MTA8FIA0R5IAA	38.7104.063
MTA8FBIA0R5IAA	38.7104.064

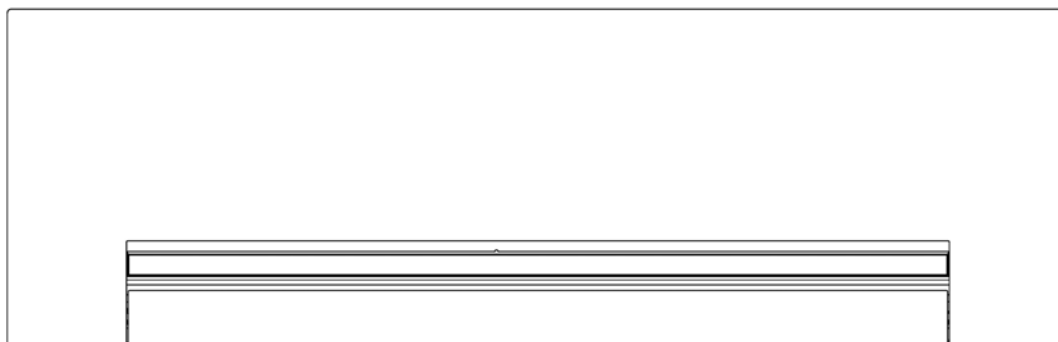

IMPORTANT! **Please read before installation**

This air conditioning system meets strict safety and operating standards.

For the installer or service person, it is important to install or service the system so that it operates safely and efficiently.

For safe installation and trouble-free operation, you must:

- Carefully read this instruction booklet before beginning.
- Follow each installation or repair step exactly as shown.
- Observe all local, state and national electrical codes.
- Pay close attention to all warning and caution notices given in this manual.

• The unit must be supplied with a dedicated electrical line.



WARNING

This symbol refers to a hazard or unsafe practice which can result in severe personal injury or death.



CAUTION

This symbol refers to a hazard or unsafe practice which can result in personal injury or product or property damage.

If necessary, get help

These instructions are all you need for most installation sites and maintenance conditions.

If you require help for a special problem, contact our sale/service outlet or your certified dealer for additional instructions.

In case of improper installation

The manufacturer shall in no way be responsible for improper installation or maintenance service, including failure to follow the instructions in this document.

SPECIAL PRECAUTIONS

- During installation, connect before the refrigerant system and then the wiring one; proceed in the reverse order when removing the units.

WARNING

When wiring



ELECTRICAL SHOCK CAN CAUSE SEVERE PERSONAL INJURY OR DEATH. ONLY A QUALIFIED, EXPERIENCED ELECTRICIANS SHOULD ATTEMPT TO WIRE THIS SYSTEM.

- Do not supply power to the unit until all wiring and tubing are completed or reconnected and checked, to ensure the grounding.
- Highly dangerous electrical voltages are used in this system. Carefully refer to the wiring diagram and these instructions when wiring. Improper connections and inadequate grounding can cause **accidental injury and death.**

- **Ground the unit** following local electrical codes.
- The Yellow/Green wire cannot be used for any connection different from the ground connection.
- Connect all wiring tightly. Loose wiring may cause overheating at connection points and a possible fire hazard.
- Do not allow wiring to touch the refrigerant tubing, compressor, or any moving parts of the fan.
- Do not use multi-core cable when wiring the power supply and control lines. Use separate cables for each type of line.

When transporting

Be careful when picking up and moving the indoor and outdoor units. Get a partner to help, and bend your knees when lifting to reduce strain on your back. Sharp edges or thin aluminium fins on the air conditioner can cut your fingers.

When installing...

... In a ceiling or wall

Make sure the ceiling/wall is strong enough to hold the unit-weight. It may be necessary to build a strong wooden or metal frame to provide added support.

... In a room

Properly insulate any tubing run inside a room to prevent "sweating", which can cause dripping and water damage to walls and floors.

... In moist or uneven locations

Use a raised concrete base to provide a solid level foundation for the outdoor unit.

This prevents damage and abnormal vibrations.

... In area with strong winds

Securely anchor the outdoor unit down with bolts and a metal frame. Provide a suitable air baffle.

... In a snowy area (for heat pump-type systems)

Install the outdoor unit on a raised platform that is higher than drifting snow. Provide snow vents.

When connecting refrigerant tubing

- Keep all tubing runs as short as possible.
- Use the flare method for connecting tubing.
- Apply refrigerant lubricant to the matching surfaces of the flare and union tubes before connecting them; screw by hand and then tighten the nut with a torque wrench for a leak-free connection.
- Check carefully for leaks before starting the test run.

NOTE:

Depending on the system type, liquid and gas lines may be either narrow or wide. Therefore, to avoid confusion, the refrigerant tubing for your particular model is specified as narrow tube for liquid, wide tube for gas.

When servicing

- Turn the power OFF at the main power board before opening the unit to check or repair electrical parts and wiring.
- Keep your fingers and clothing away from any moving parts.
- Clean up the site after the work, remembering to check that no metal scraps or bits of wiring have been left inside the unit being serviced.
- Ventilate the room during the installation or testing the refrigeration system; make sure that, after the installation, no gas leaks are present, because this could produce toxic gas and dangerous if in contact with flames or heat-sources.

Table of Contents

	Page
1. SPECIFICATIONS	4
1-1 Unit specifications	4
1-2 Major Component specifications	6
1-3 Other Component specifications	8
2. DIMENSIONAL DATA	9
3. PERFORMANCE DATA	10
3-1 Air Throw Distance Chart	11
4. ELECTRICAL DATA	12
4-1 Electric Wiring Diagrams	12
5. FUNCTION	13
5-1 System operation control	13
5-2 Cool Mode Operation	14
5-3 Heat Mode Operation	14
5-4 Auto Mode Operation	15
5-5 Dry Mode Operation	16
5-6 Fan Mode Operation	16
5-7 Auto Fan Speed	16
5-8 Forced-Made	17
5-9 Protection Operations in indoor unit	17
5-10 Protection Operation outdoor unit	18
5-11 Defrost	19
5-12 I Feel Function	19
5-13 Hi Power mode	19
5-14 Night Function	20
5-15 Leds off function	20
5-16 Capacity Test Mode	20
5-17 Diagnostic	21
5-18 Indoor unit jumpers Configuration	22
5-19 Outdoor unit jumpers Configuration	23
5-20 Contacts for building automation	23
5-21 Maintenance	25
6. TROUBLESHOOTING	26
6-1 Check before and after troubleshooting	26
6-2 Circuit Breaker Trips or Fuse Blows	26
6-3 System does not run	27
6-4 Outdoor unit does not run and no fault is displayed	29
6-5 Only outdoor unit is off	29
6-6 Fault on outdoor unit	30
6-7 Air Conditioner operates, but abnormalities are observed	31
6-8 Noise problem	33
7. CHECKING ELETRICAL COMPONENTS	34
7-1 Measurement of Insulation Resistance	34
7-2 Checking Continuity of Fuse on PCB Assy	35
7-3 Checking motor capacitor	35

1. SPECIFICATIONS

1-1 Unit Specifications

Power source	220 - 240 V ~ 50 Hz
---------------------	---------------------

Voltage rating	230 V - 50 Hz
-----------------------	---------------

Performance	Cooling	Heating
Capacity	See catalogue with the requested matching	
Air circulation (High)	m ³ /h	600

Features			
Controls/Temperature controls		Microprocessor/ I.C. thermostat	
Control unit		Wireless remote control unit	
Timer		ON/OFF 24 hours & Daily program, 1-hour OFF	
Fan speed		3 and Auto	
Airflow direction		Horizontal	Manual
		Vertical	Auto
Air Filter		Washable, Anti-Mold	
Power noise level	High/Med./Low	dB-A	39/36/29
Refrigerant tubing connections		Flare type	
Refrigerant tube diameter	Narrow tube	mm(in.)	6.35 (1/4)
	Wide tube	mm(in.)	9.52 (3/8)
Refrigerant		R410A	
Refrigerant tube kit / Air clean filter		Optional / Optional	

Dimensions & Weight			
Unit dimensions	Height	mm	305
	Width	mm	895
	Depth	mm	195 (110 Built-in)
Package dimensions	Height	mm	350
	Width	mm	950
	Depth	mm	265
Weight	Net	kg	12:00
	Shipping	kg	13
Shipping volume		m ³	0.088

DATA SUBJECT TO CHANGE WITHOUT NOTICE

1-2 Major Component Specifications

Controller PCB	
Part No.	SAC DCI IDU
Controls	Microprocessor
Control circuit fuse	250 V - 3,15 A

Remote Control Unit	SAC W-REM V3
----------------------------	--------------

Fan & Fan Motor	
Type	Cross - flow
Q'ty Dia. and length	mm 1.... Ø 90,5 / L 669,5
Fan motor model...Q'ty	KFV4Q-11SB5P...1
No. Of poles...rpm (230 V, Hi)	4...1160
Nominal output	W 10
Coil resistance (Ambient temp. 20 °C)	Ω BRN-WHT: 561,8
	VLT-WHT: 197,4
	VLT-ORG: 63,4
	YEL-ORG: 155,7
	YEL-PNK: 115,9
Safety devices	Type internal fuse
	Operating temp. Open °C 145 ± 5
	Close -
Run capacitor	μF 1
	VAC 440

Functional Flap Motor / Aesthetics Flap Motor	
Type	Stepping motor
Model	MP24Z2 / MP24Z
Rating	DC 12 V
Coil resistance (Ambient temp. 25 °C)	Ω 400 ± 7%

Heat Exch. Coil	
Coil	Aluminium plate fin / Copper tube
Rows	2
Fin pitch	mm 1,3
Face area	0,238

DATA SUBJECT TO CHANGE WITHOUT NOTICE

1-3 Other Component Specifications

Trasformer (TR)		0028TRA008
Rating	Primary Secondary Capacity	AC 230 V, 50 Hz 13 V - 6VA
Coil resistance	Ω (at 25°C)	Primary: - Secondary: -
Thermal cut-off temp.		120°C

Thermistor (Coil sensor)		NTC-THERMISTOR
Resistance	k Ω	10 at 25 °C

Thermistor (Room sensor)		NTC-THERMISTOR
Resistance	k Ω	10 at 25 °C

2. DIMENSIONAL DATA

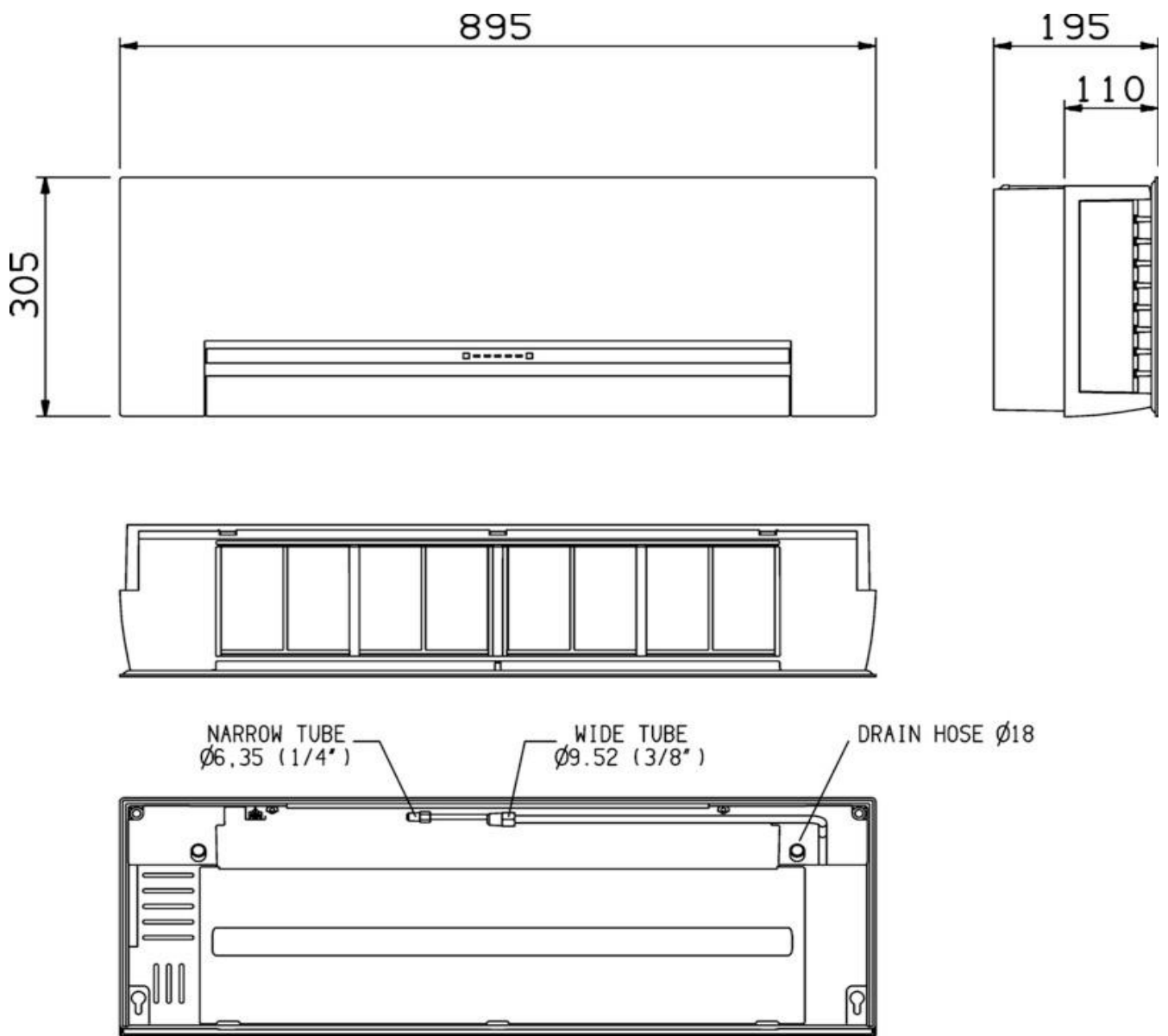

3. PERFORMANCE DATA

3-1 Air Throw Distance Chart

Cooling

Room air temp. : 27°C
 Fan speed : High

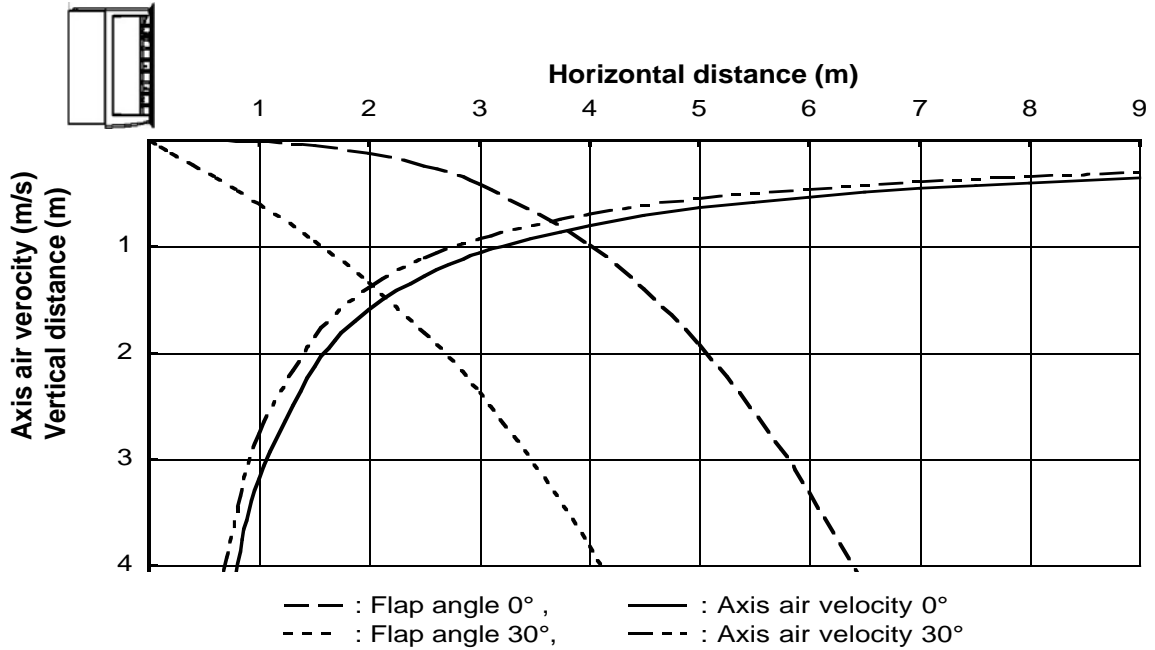

Heating

Room air temp. : 20°C
 Fan speed : High

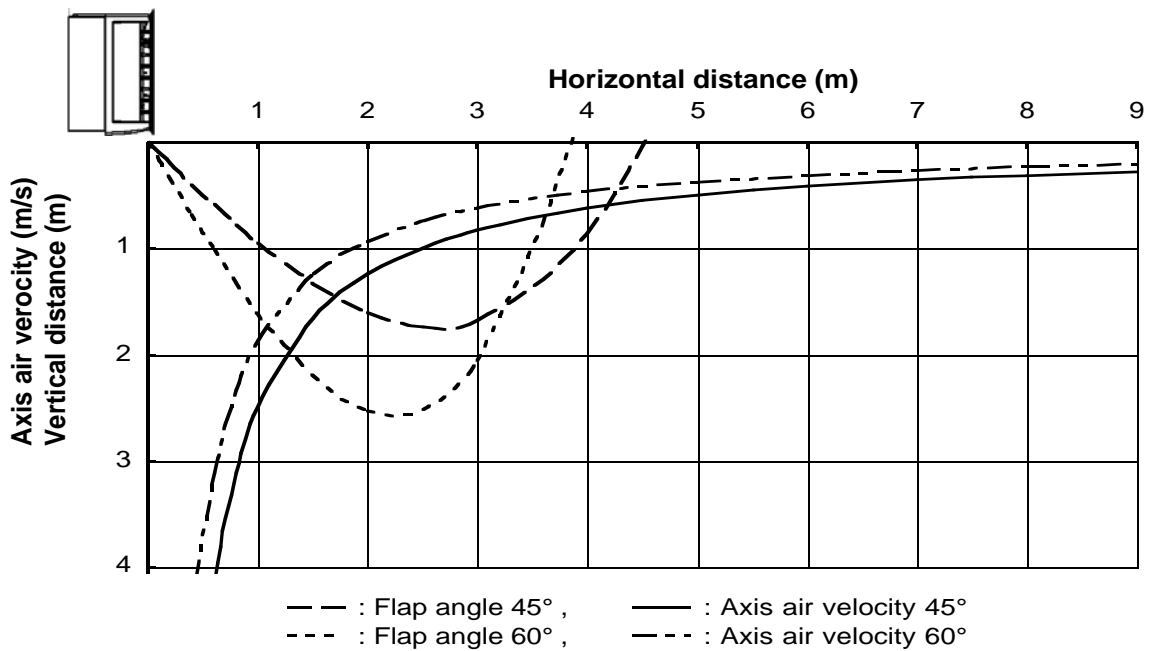

4. ELECTRICAL DATA

4-1 Electric Wiring Diagrams

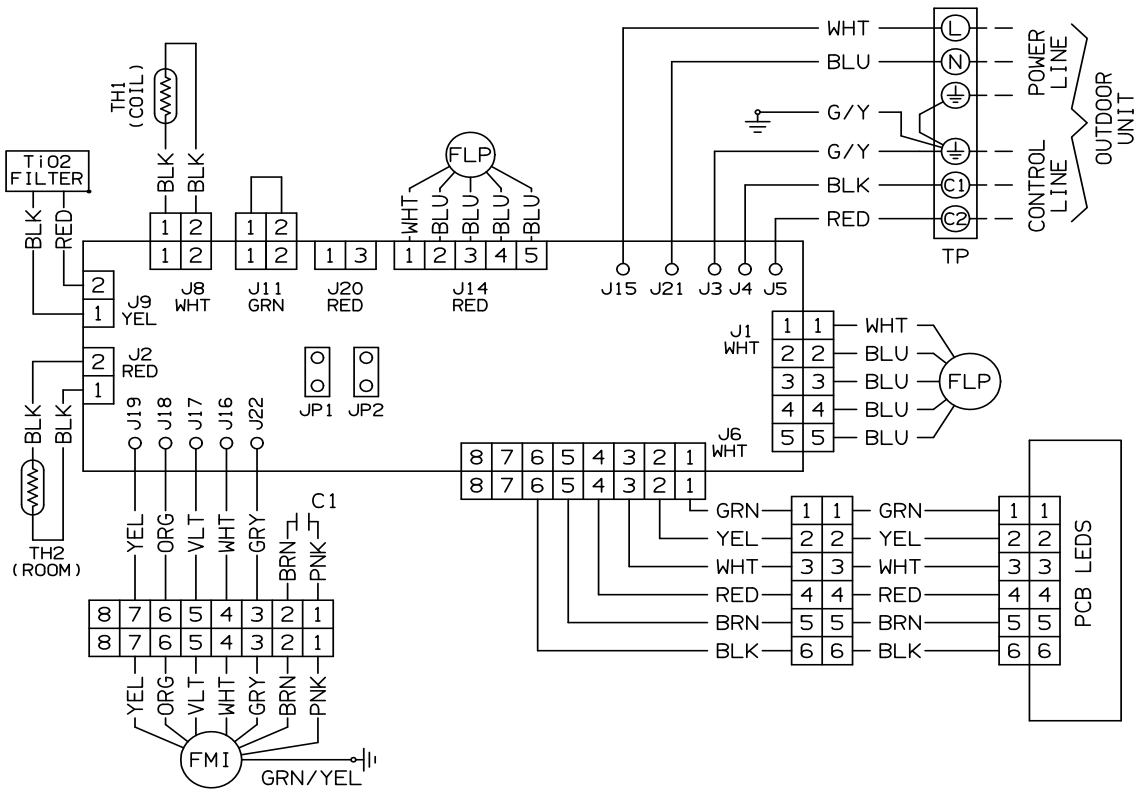

5.FUNCTION

5-1 System operation control

The inputs to the systems come from indoor and outdoor sensors. The outdoor unit is the system MASTER while the indoor one is the SLAVE.

Communication between units is made with a 2 poles RS485 bus

The indoor units receives the user input (fan speed, flap position etc) through remote controller which sends signal every time a button is pressed and in any case, automatically, every 5 minutes.

5.1.1 control specification

During operation compressor speed can be subjected to change due to thermal load variations or protection activations but in any case:

- The minimum time interval between an OFF and a ON operation is not lower than 3 minutes
- The minimum operating time is not lower than 3 minutes
- The maximum acceleration/deceleration rate is fixed at 20rpm /sec
- During the start-up compressor speed increases according to a defined rule which is independent from the thermal load calculation.

5-2 Cool Mode Operation

In Cooling Mode, the operation of the compressor (CM), Outdoor Fan (FMO) and Indoor Fan (FMI) are determined by:

- 1) the difference between the room air temperature (RAT) and the set point temperature (SPT)
- 2) the protection level at which the system is operating
- 3) the thermal load in the room

NOTES

In addition to the temperature difference of above, the operation of the main components (CM, FMO, FMI) is also controlled by protection function.

The minimum off time of compressor is 3 minutes.

The indoor fan can change speed only after it has operated at the same speed for 30 sec if in AUTO and 1 sec for the other settings (High, Med, Low).

5-3 Heat Mode Operation

The Heating mode operation is similar to the Cooling mode operation. The CM, FMO and FMI are controlled by the same parameters.

The FMI will not be turned on until the indoor coil temperature is warm enough to prevent the supply of cold air (see COLD DRAFT PREVENTION feature for details).

The indoor fan can change speed only after it has operated at the same speed for 30 sec if in AUTO and 1 sec for the other settings (High, Med, Low).

5-4 Auto Mode Operation

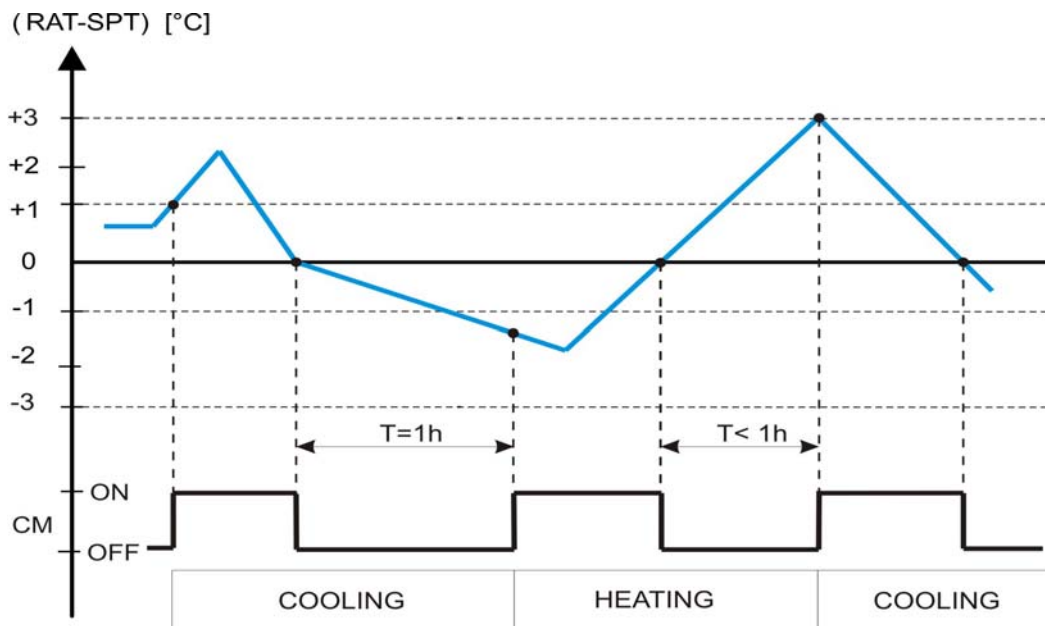

In Auto Mode, the unit switches automatically between the Auto Cooling and Auto Heating in order to maintain the room temperature (RAT) at the prescribed set point (SPT).

The switching between the two modes is according to the above graph and following table

COOLING ---> HEATING
If $-3^{\circ}\text{C} \leq \text{Dt} \leq -1^{\circ}\text{C}$ and the compressor is off for more than 1 hour
If $\text{Dt} \leq -3^{\circ}\text{C}$ and compressor is off for more than 3 minutes
HEATING ---> COOLING
If $1^{\circ}\text{C} \leq \text{Dt} \leq 3^{\circ}\text{C}$ and the compressor is off for more than 1 hour
If $\text{Dt} \geq 3^{\circ}\text{C}$ and compressor is off for more than 3 minutes

$$\text{Dt} = \text{RAT} - \text{SPT}$$

Refer to the sections 5.1 COOLING MODE and 5.2 HEATING MODE for system operation details.

5-5 Dry Mode Operation

Dry operation remove moisture from indoor air running, in cooling mode, at a low level without reducing the ambient temperature. This is done cycling ON and OFF indoor and outdoor units according to below.

ROOM TEMP	DRY LEVEL	
$\geq \text{SPT}+2^{\circ}\text{C}$	LEVEL 0	Operation according to COOLING mode
$< \text{SPT}+2^{\circ}\text{C}$ $\geq \text{SPT}-1^{\circ}\text{C}$	LEVEL 1	CM on at constant speed FMO on at constant speed FMI switches between L and LL every 30 seconds RV off
$< \text{SPT}-1^{\circ}\text{C}$ $\geq 15^{\circ}\text{C}$	LEVEL 2	CM switches 9 minutes off and 3 minutes on FMO switches 9 minutes off and 3 minutes ON FMI switches between L and LL every 30 seconds RV off
$< 15^{\circ}\text{C}$	DRY OFF ZONE	CM off FMO off FMI off RV off

SPT = Set Point Temperature

5-6 Fan Mode Operation

With this mode, the indoor fan is turned on while CM, FMO and RV stay off all the time. The user can select between 3 speeds: HIGH, MEDIUM and LOW.

5-7 Auto Fan speed

With this option selected, the indoor fan speed changes automatically according to the compressor speed: as shown in the following graphs

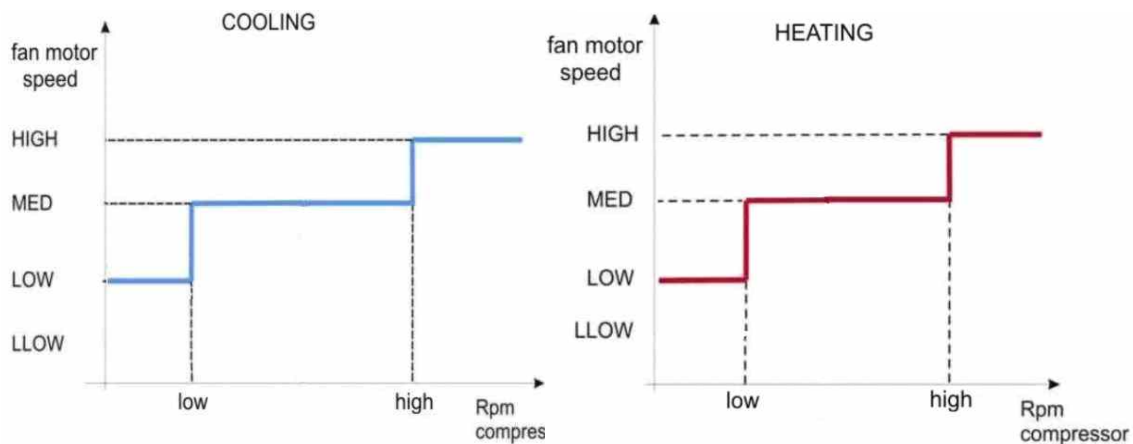

to prevent the supply of cool air, the FMI speed is setted as shown only if the indoor coil temperature $\text{ICT} \geq 32^{\circ}\text{C}$ (see COLD DRAFT PREVENTION feature for details)

5-8 Forced Mode

In this mode the system operates (COOLING or HEATING mode – fixed settings) or is switched off by means of the MODE button on the indoor unit control board. The operation modes can be selected pressing the button in a cyclic way (OFF ⇒ COOL ⇒ HEAT ⇒ OFF...). The settings are:

COOLING mode

SET POINT temperature = 25°C
FAN SPEED = HIGH
FLAP POSITION = 3

HEATING mode

SET POINT temperature = 21°C
FAN SPEED = HIGH
FLAP POSITION = 4

5-9 Protection operations indoor unit

5-9.1 Freeze-up

This protection prevents ice formation on the indoor coil heat exchanger. The protection is activated as soon as the indoor coil temperature ICT decreases and acts by decreasing the compressor speed

The system exit this protection routine when ICT temperature rises above 5°C.

5-9.2 Cold draft

This feature prevents the supply of cold air forcing the indoor fan to a speed which cannot be changed by the user.

If the ICT temperature goes down 32°C (in descending) or does not reach 37°C (in rising), the speed fan is set as shown below.

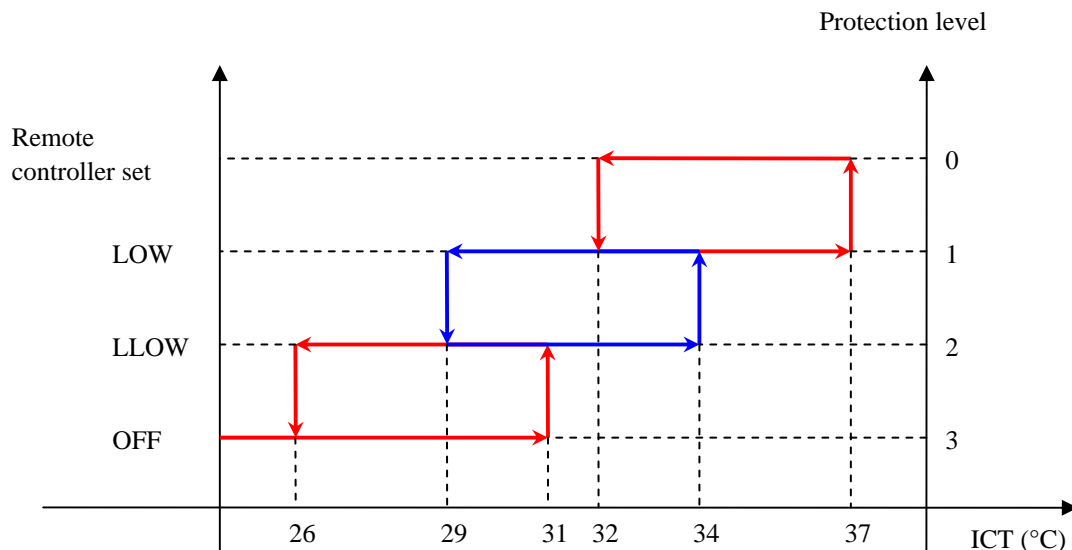

5-9.3 Overheat

This feature prevents the build up of high pressure in the indoor heat exchanger during heating operation. As soon as the indoor coil temperature (ICT) increases, compressor speed is reduced in order to avoid heat exchanger overheating. System stops compressor operation when ICT reaches 60 °C

5-10 Protection operations on outdoor unit

5-10.1 Overheating

During cooling operation as soon as the outdoor coil temperature (OCT) increases, compressor speed is reduced in order to avoid heat exchanger overheating. System stops compressor operation when OCT reaches 60 °C

5-10.2 Compressor discharge temperature

During operation, as soon as the discharge temperature increases, (CDT) compressor speed is reduced in order to avoid overheating of the motor. Compressor is stopped when CDT reaches 110°C

5-10.3 Compressor power-module overheating

The module temperature, detected by a built-in thermistor, is always monitored by the control system and kept operating in a safe area. If temperature exceeds 100°C, operation is automatically stopped.

5-10.4 Outdoor fan power-module overheating

The module temperature, detected by a built-in thermistor, is always monitored by the control system and kept operating in a safe area. If temperature exceeds 100°C, operation is automatically stopped.

5-10.5 Compressor power-module overcurrent

Operation is automatically stopped in case of current driven to each motor phase greater than a value depending on the power of the outdoor unit (9A for 12000btu and 11A for 18000btu)

5-10.6 Outdoor fan power-module overcurrent

In case of current driven to each motor phase greater than 300mA operation is automatically stopped

5-11 Defrost

5.11.2 Defrost

The defrost process is controlled by a detection algorithm designed in order to maintain optimal utilization of the heat pump capacity especially during negative outdoor temperature conditions.

System condition:

- Compressor speed fixed
- Expansion valve opening fixed
- Outdoor fan switched off
- Indoor fan controlled by cold draft prevention
- Defrost valve switched on (open)
- Reversing valve switched on (heating operation)

NOTES:

- Minimum defrost time interval is 2 minutes
- During HIGH POWER operation the defrost detection is ignored until this mode remains active
- System exits defrost protection as soon as 14°C on the outdoor coil are detected and, in any case, if at least 12 minutes are elapsed from the start of the defrost cycle.

I FEEL function

As standard configuration the air conditioner operates detecting the room temperature through the sensor equipped in the wireless remote controller (icon I FEEL shown on the display). This feature provides a personalised environment since the temperature can be detected where the remote controller is located. It is possible to de-activate this option pressing the I FEEL button on the remote controller. In this case the I FEEL icon is no longer displayed and room temperature is detected through the sensor included in the indoor unit.

5-12 HI POWER mode

When this mode is active the internal fan speed is set automatically and the air conditioner operates, for 15 minutes, at the maximum power. After 15 minutes from the selection the mode is automatically switched off.

5-13 HI POWER mode

When this mode is active the internal fan speed is set automatically and the air conditioner operates, for 15 minutes, at the maximum power. After 15 minutes from the selection the mode is automatically switched off.

5-14 NIGHT Function

When this setting is active indoor fan speed is automatically reduced in order to allow low noise operation. Temperature control acts in the same way as NORMAL MODE but after 60 minutes of operation the air conditioner modifies automatically the set-point temperature according to the following:

- COOLING/DRY: +1°C
- HEATING: - 2°C

5-15 LEDS OFF function

This is a special function mode which can be selected by the user pressing, at the same for more than 5 seconds the IFEEL and FAN buttons on the remote controller. With this option active the OPERATION, TIMER and STANDBY lamps are switched off even during operation (they activates only in case of diagnostic signaling).

5-16 Capacity Test mode

This is a special operating mode used when testing the performance of the A/C. In this case the main components of the A/C (compressor , outdoor fan, indoor fan, expansion valve) operate at fixed settings. This option is activated shorting the JP1 and JP3 jumpers on the outdoor pcb and setting the remote controller according to the following:

- COOLING MODE: Setpoint = 10°C / I-FEEL OFF
- HEATING MODE: Setpoint = 32°C / I-FEEL OFF

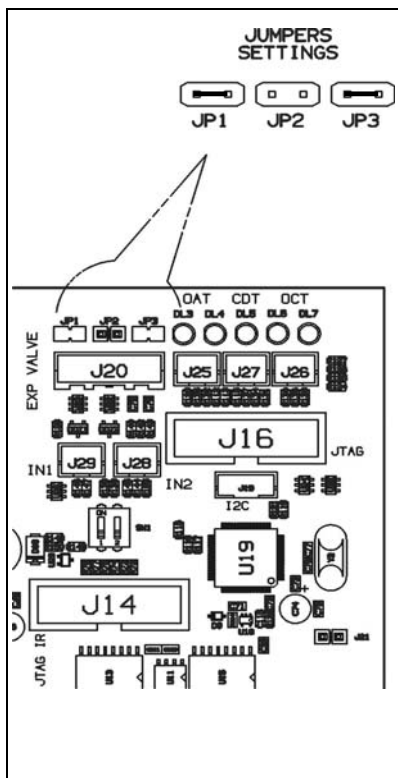

5-17 Diagnostic

With this feature is possible to have a visual signal that a trouble is occurring.

This mode is always active and the signalling is made through the display board LEDS .

In case of no troubles the LEDS status follows its normal function.

The detected troubles are showed to the user/technician using the 3 leds of the indoor unit receiver and the 5 leds on the outdoor pcb. For each fault there are different effects upon the operation of the A/C:

NOTES

- The troubles are showed according to a priority list that is in case of more than one trouble present, is always showed, at first, the one with the highest priority (3 ⇨ 2 ⇨ 1 etc).
- Sensor damaged means a situation where sensor is short-circuited or opened.
- In case of damaged sensors, the system (CM, FMO, FMI etc), if in OFF state, does not start.

Priority	INDOOR UNIT FAULT	LEDS status					EFFECTS
		LD1 tmr	LD2 opr	LD3 stby	LD4 opr	LD5 tmr	
4	RAT probe damaged	O	F	F	F	O	system does not operate.
3	ICT probe damaged	F	F	O	F	F	as soon as fault is cleared, the system automatically restart after 3 min
2	communication error	F	F	F	F	F	
1	fault on outdoor unit	O	O	F	O	O	during this time, the signalling is showed
0	wrong mode selected	F	●	F	●	F	system does not operate. to restart the system, select correct mode

O = LED off

F = LED blinking

● = LED on

5-18 INDOOR UNIT JUMPERS CONFIGURATION

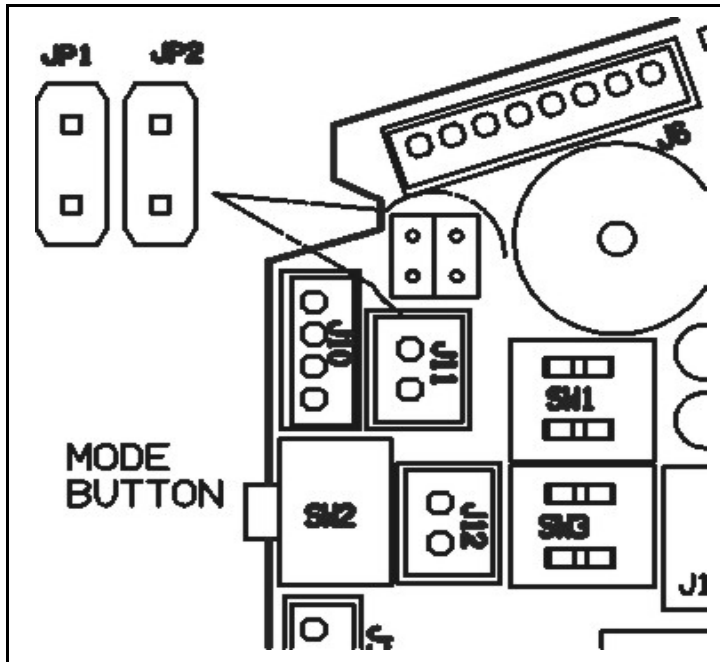

Unit is shipped with jumpers set according to the following table:

JUMPER	STATUS
JP1	open
JP2	open

5-19 OUTDOOR UNIT JUMPERS CONFIGURATION

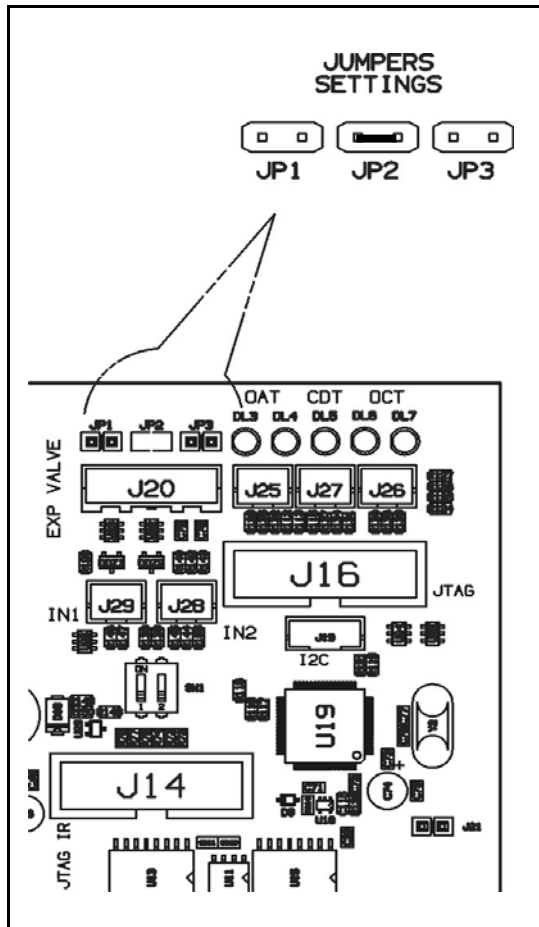

Unit is shipped with jumpers set according to the following table:

models: GR9FI40R5IAA	
JUMPER	STATUS
JP1	open
JP2	closed
JP3	open

5-20 CONTACTS FOR BUILDING AUTOMATION

5-20.1 INPUT CONTACT (J11 - green)

The status of this input affects system operation according to the following:

- Contact OPEN : system does not operate (always OFF) – inputs from wireless remote controller are not processed
- Contact CLOSED: system operates in the normal way according to the inputs coming from wireless remote controller

5-20.2 OUTPUT CONTACT (J20)

This connector is directly tied to the contact (normally open) of a power relay which activates every time the following alarm condition occur:

- RAT damaged
- ICT damaged
- Communication error
- Fault on outdoor unit

In this case when alarm happens, on poles 1 and 3 of J20 connector, 220 VAC-50Hz are available.
Max electrical load: **1A- 240VAC**

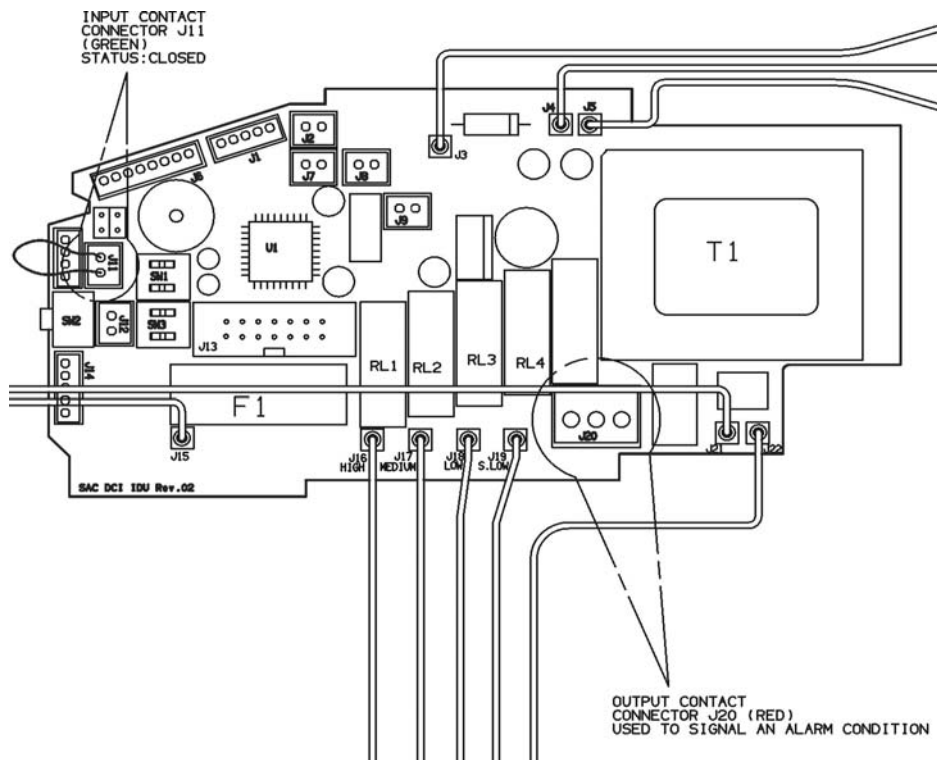

5-21 MAINTENANCE

5-21.1 Changing the Address of the Air Conditioner

In case of more than one air conditioner operating in the same room, it may be necessary to assign an address to each unit in order to avoid operation conflicts. Address is set acting on the dip-switches located on the indoor PCB and on the remote controller. The PCB settings must match the corresponding ones on the wireless remote controller.

How to change address of the air conditioner

Set the PCB to the address desired

UNIT ADDRESS	SETTINGS	
	1	2
1	off	off
2	off	on
3	on	off
4	on	on

As default, switches 1 and 2 are in 'off' status (PCB factory state).

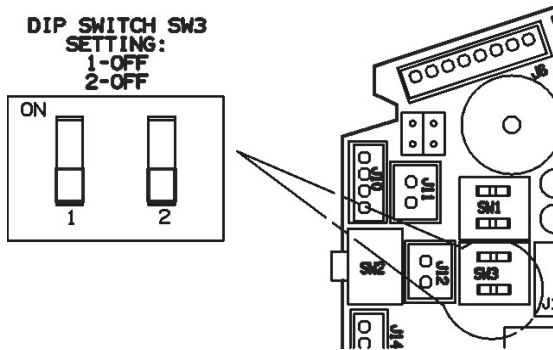

How to change address on Remote Control Unit

Dip switch is located on the battery compartment.

As default switches 1 and 2 are in 'off' status while 3 and 4 are in 'on' status (remote controller factory state).

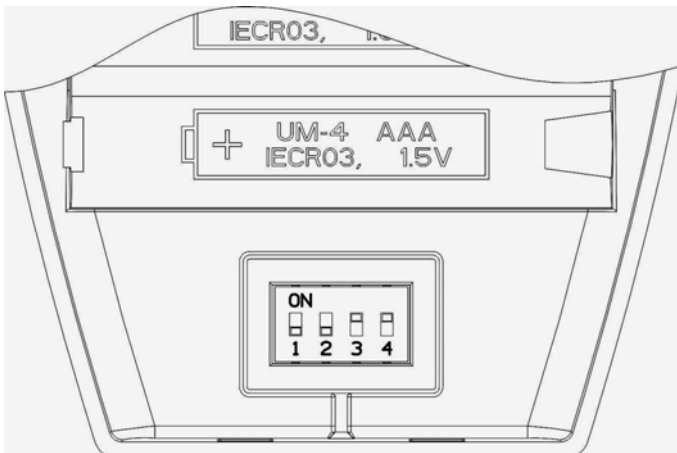

6) TROUBLESHOOTING

6-1 CHECK BEFORE AND AFTER «TROUBLESHOOTING»

(A) Check power supply wiring.

- Check the power supply wires are correctly connected.

(B) Check power supply.

- Check that voltage is in specified range ($\pm 10\%$ of the rating).
- Check that power is being supplied.

• **WARNING:** If the following troubleshooting must be done with power supplied, be careful not to touch any uninsulated live part that can cause *electric shock*

6-2 CIRCUIT BREAKER TRIPS OR FUSE BLOWS.

- When circuit breaker is set to ON, it trips in a few moments. Resetting is not possible.
- Measure insulation resistance. There is a possibility of ground fault.
If resistance value is 1 Mohm or less, insulation is defective.

6-3 SYSTEM DOES NOT RUN.

1 - THERE IS NO SIGNALING LED ON INDOOR UNIT

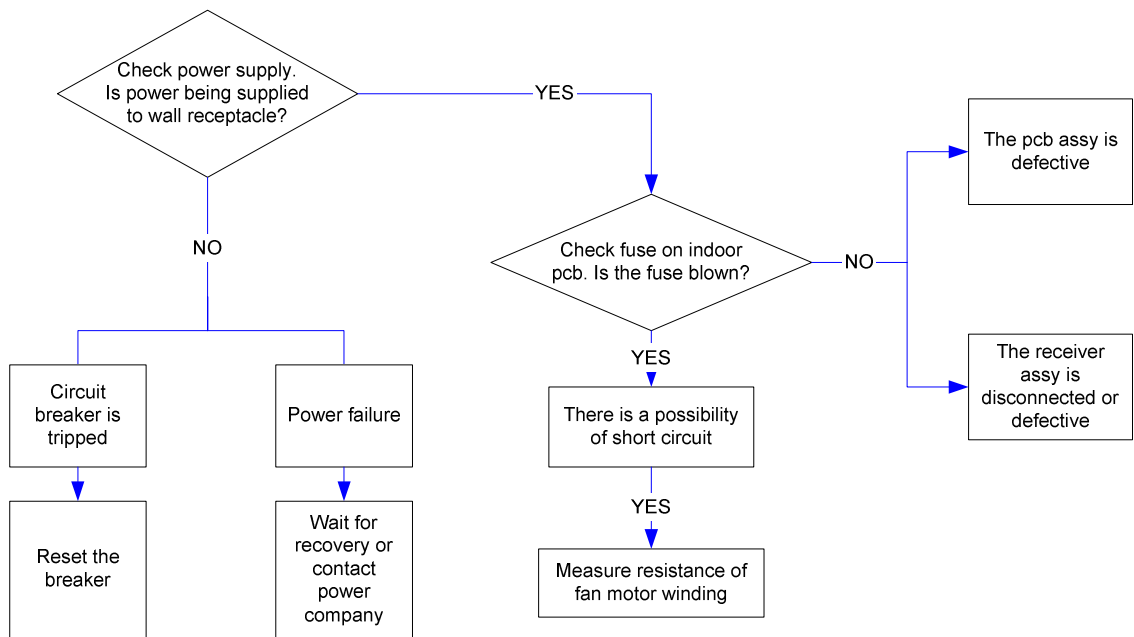

2 - IN INDOOR UNIT THERE IS ONE LED ON AT LEAST AND THE UNIT RECEIVES THE REMOTE CONTROL SIGNAL

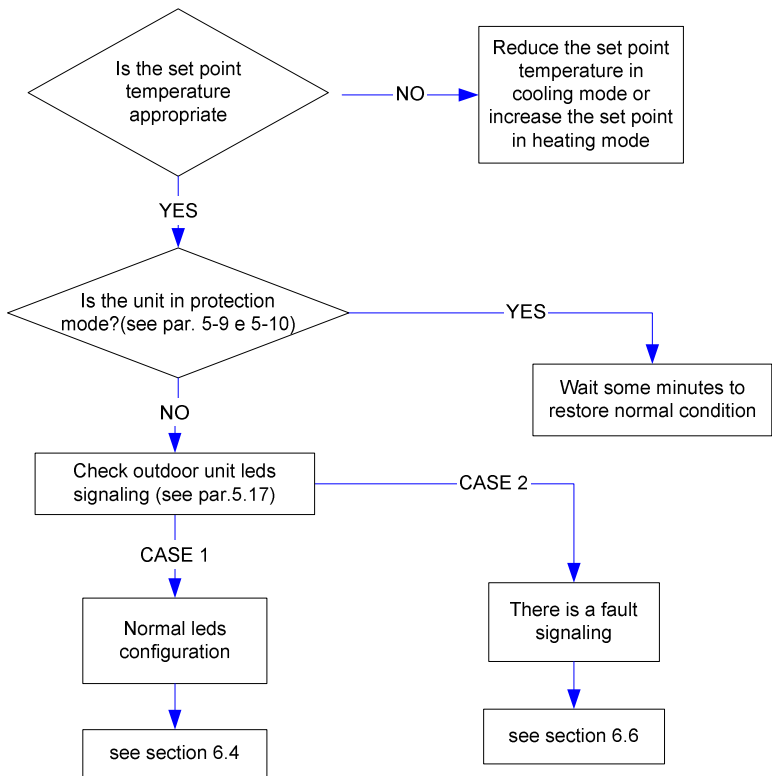

6-3 SYSTEM DOES NOT RUN.

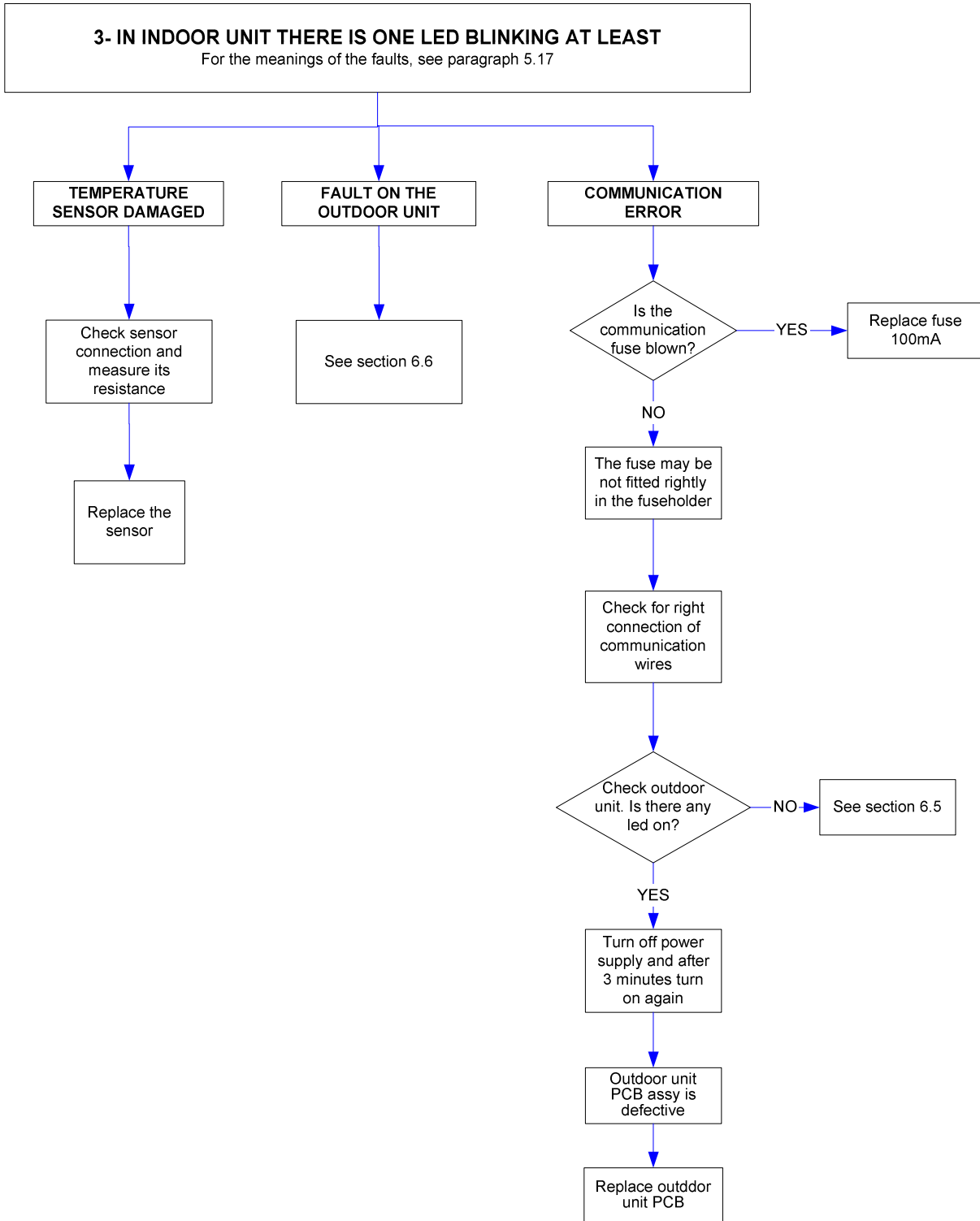

6-4 OUTDOOR UNIT DOES NOT RUN AND NO FAULT IS DISPLAYED

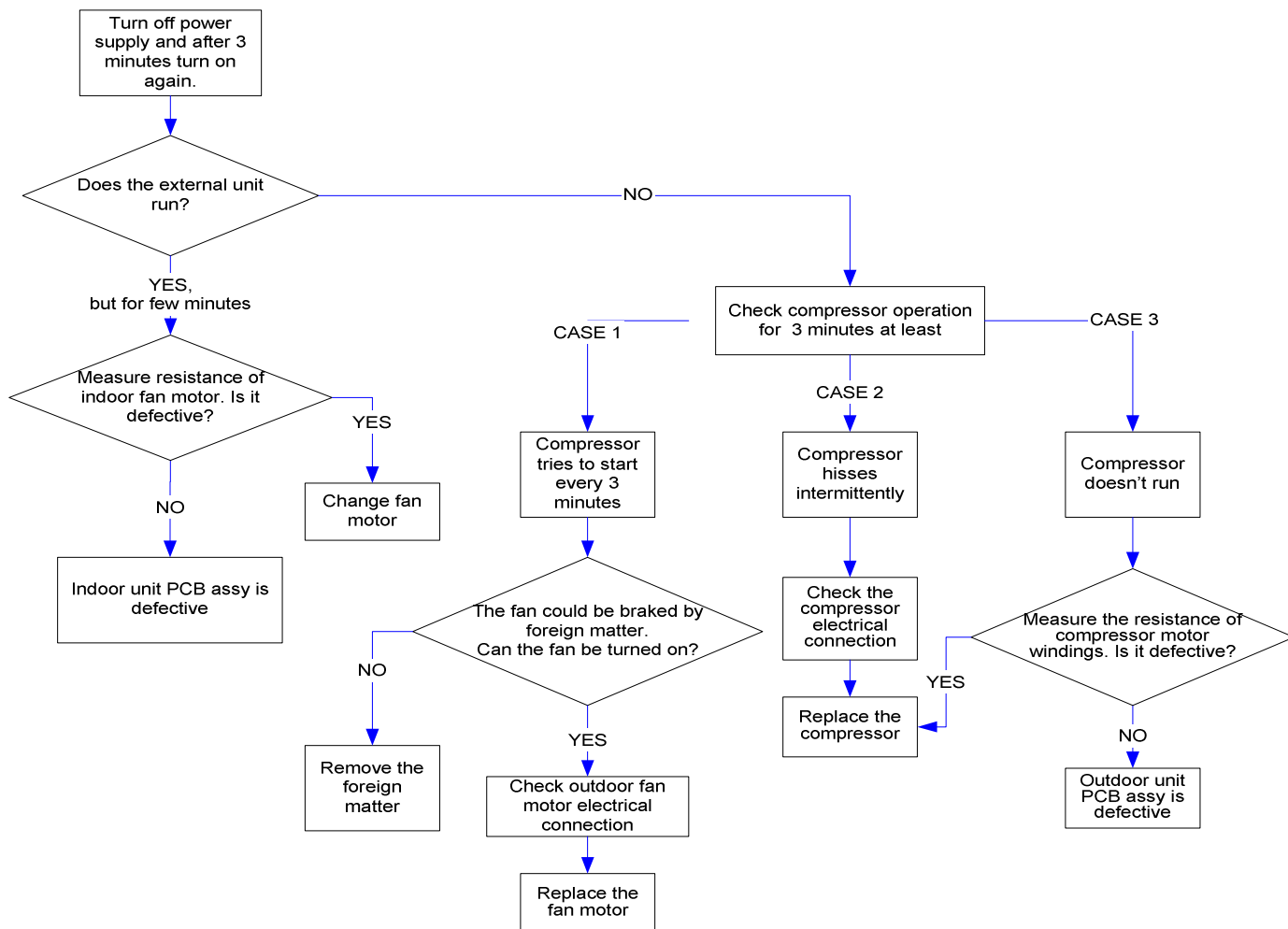

6-5 ONLY OUTDOOR UNIT IS OFF

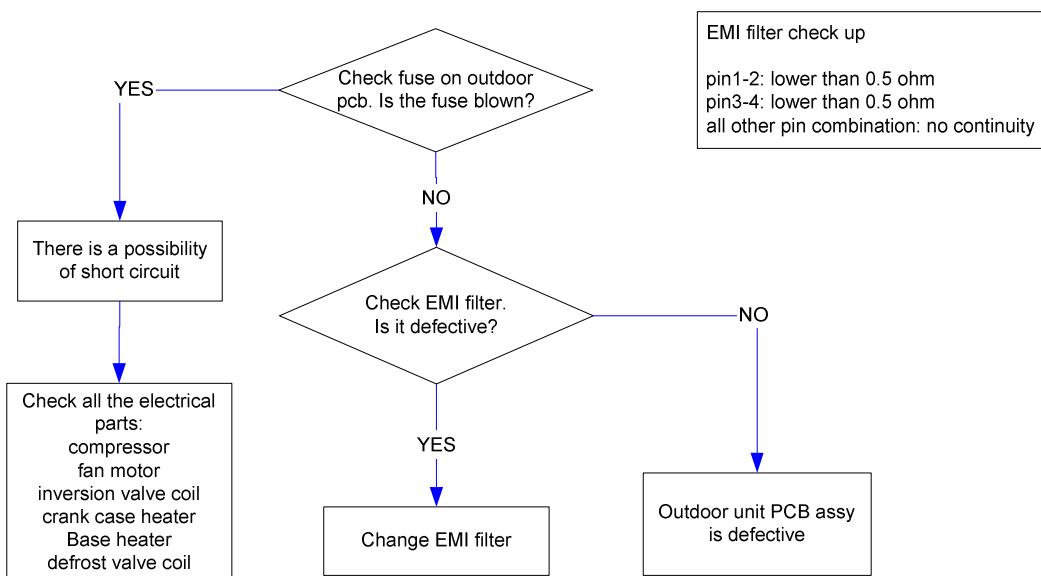

6-6 OUTDOOR UNIT: FAULT SIGNALING

IN OUTDOOR UNIT THERE IS ONE LED BLINKING AT LEAST

For the meanings of the faults, see paragraph 5.17

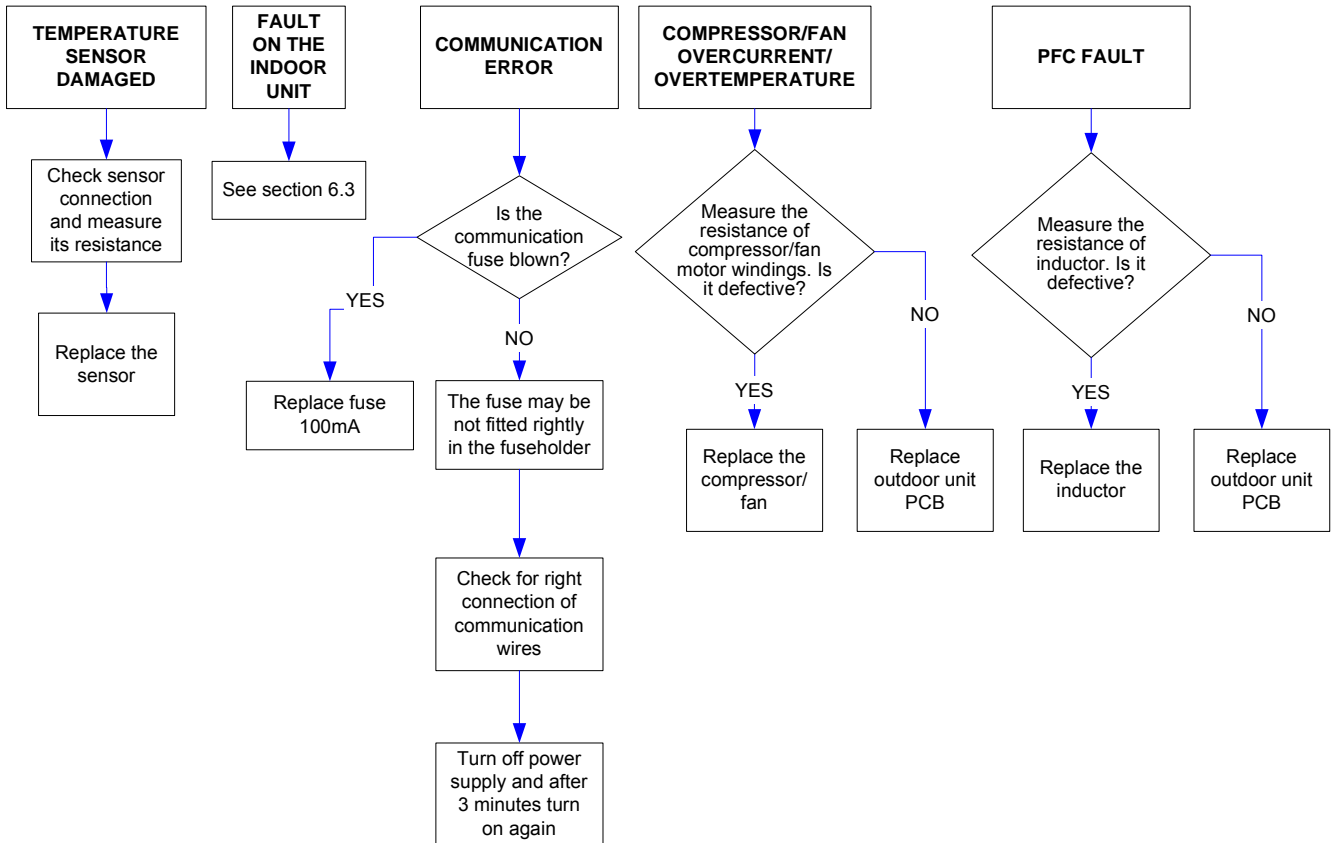

6-7 AIR CONDITIONER OPERATES, BUT ABNORMALITIES ARE OBSERVED.

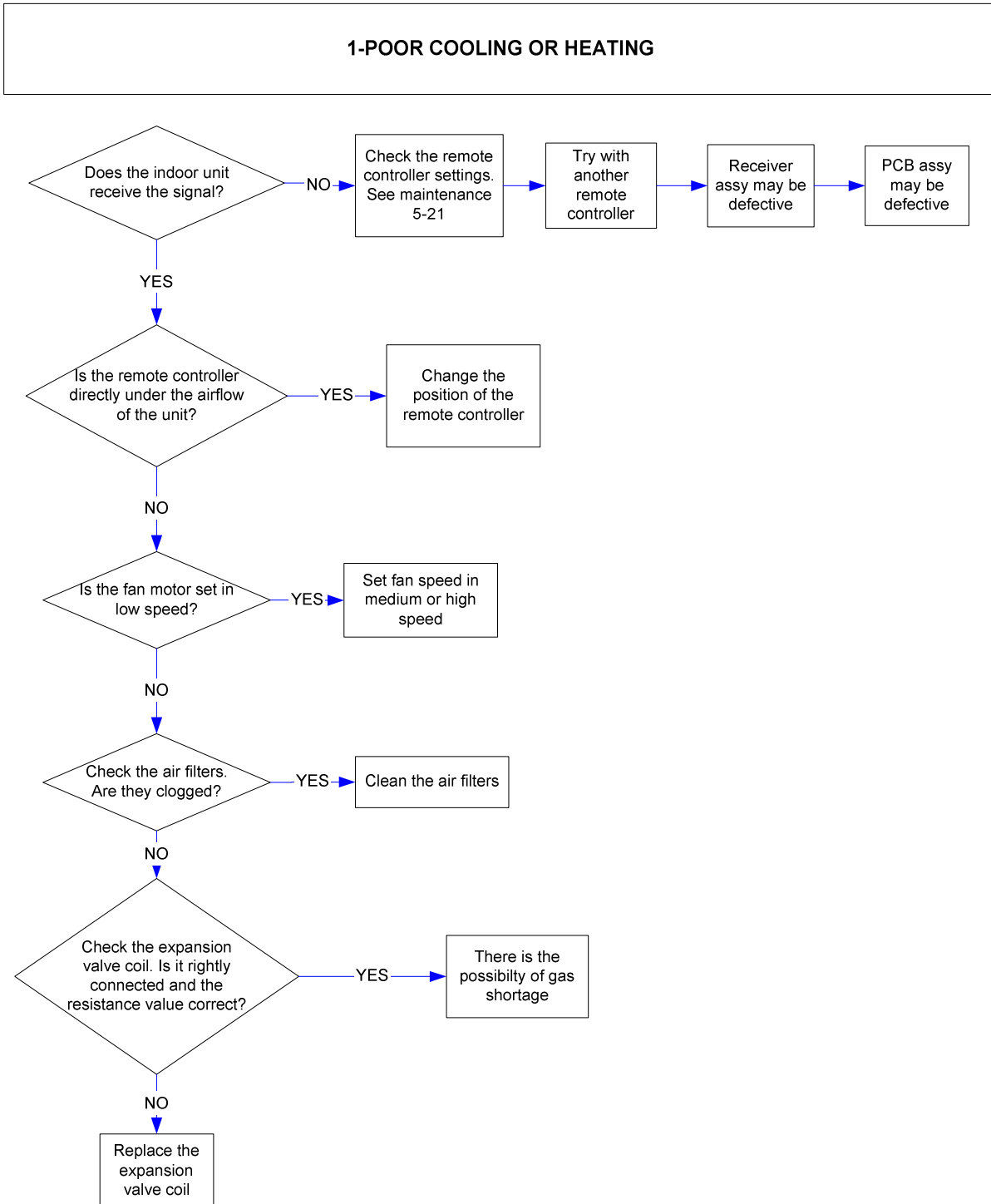

2 - OPERATION DOES NOT SWITCH FROM HEAT TO COOL AND FROM COOL TO HEAT

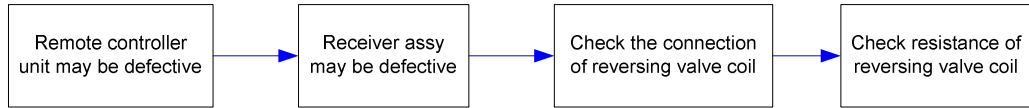

3 - CHECK "MODE BUTTON" OPERATION ON THE UNIT

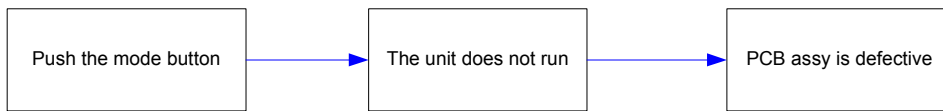

4 - CHECK REMOTE CONTROLLER UNIT

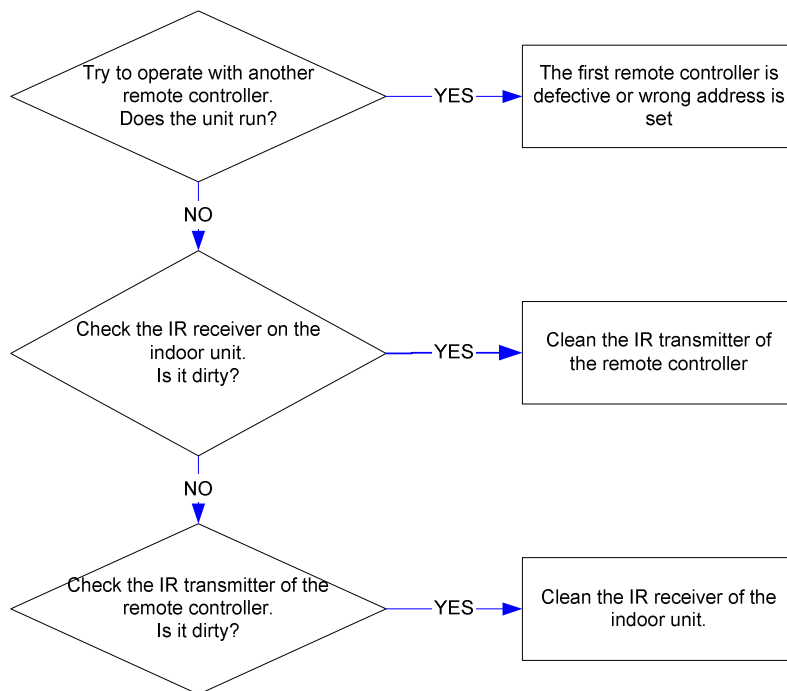

6-8 NOISY PROBLEM

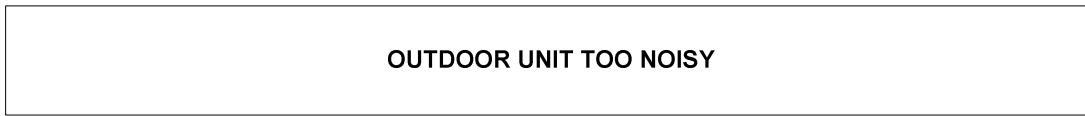

Check that all the pannel are fixed.

Check the position of cushion rubbers under the compressor

Check that internal tubes are not touching each other or with other components.

Add dampers under the unit

7) CHECKING ELETRICAL COMPONENTS

7-1 Measurement of Insulation Resistance

- The insulation is in good condition if the resistance exceeds 1M Ω m.

a) Power Supply Wires

Clamp the earthed wire of the power supply wires with the lead clip of the insulation resistance tester and measure the resistance by placing a probe on either of the power wires (Fig. 1).

Then measure the resistance between the earthed wire and the other power wires (Fig. 1).

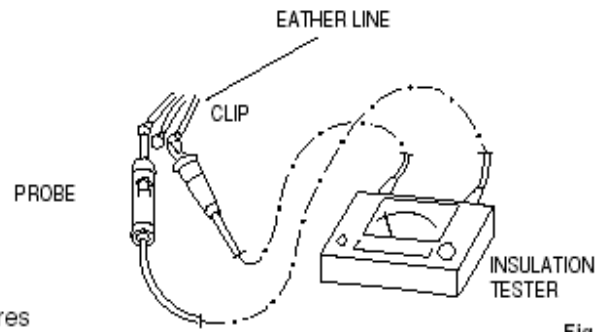

Fig. 1

b) Unit

Clamp an aluminium plate fin or copper tube with the lead clip of the insulation resistance tester and measure the resistance by placing a probe on N terminal, and then on L terminal the terminal plate (Fig. 2).

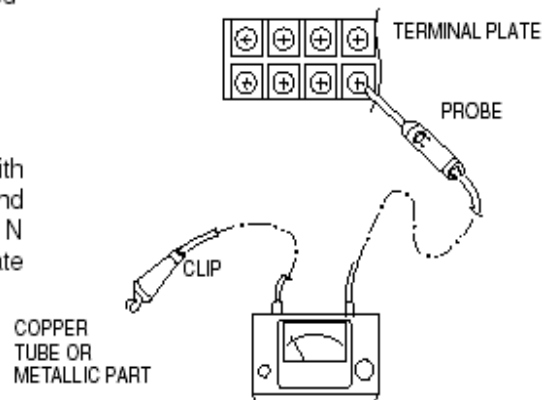

Fig. 2

c) Measurement of Insulation Resistance for Electrical Parts

Disconnect the lead wires of the disired electric part from terminal plate, PCB Ass'y, capacitor, etc. Similarly disconnect the connector. Then measure the insuration resistance. (Fig. 1 to 4).

Refer to Electric Wiring Diagram

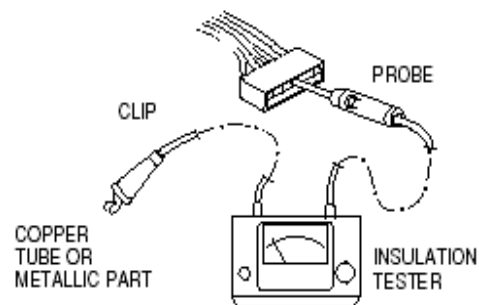

Fig. 3

NOTE

- If the probe cannot enter the poles because the hole is too narrow then use a probe with a thinner pin.

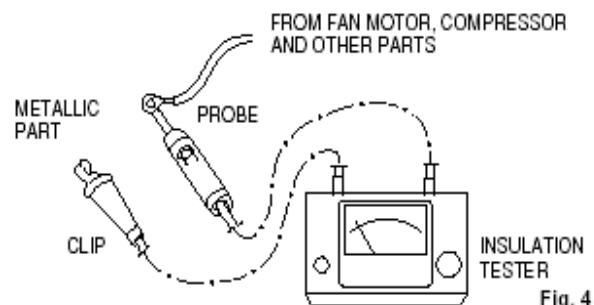

Fig. 4

7-2 Checking Continuity of Fuse on PCB Ass'y

- Remove PCB Ass'y from electrical component box. (Fig. 5).
- Then pull out the fuse from PCB Ass'y.

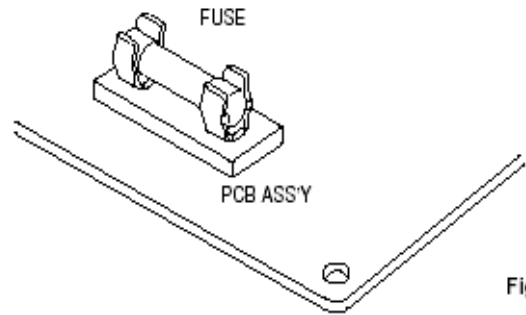

Fig. 5

- Check continuity of fuse by the multimeter (Fig. 6).

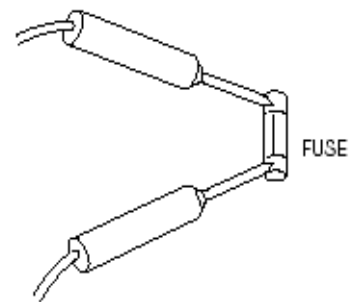

Fig. 6

3) Checking Motor Capacitor

- Remove the lead wires from the capacitor terminals, and then place a probe on the capacitor terminals as shown in Fig. 7. Observe the deflection of the pointer, setting the resistance measuring range of the multimeter to the maximum value. The capacitor is "good" if the pointer bounces to a great extent and then gradually returns to its original position. The range of deflection and deflection time differ according to capacity of the capacitor.

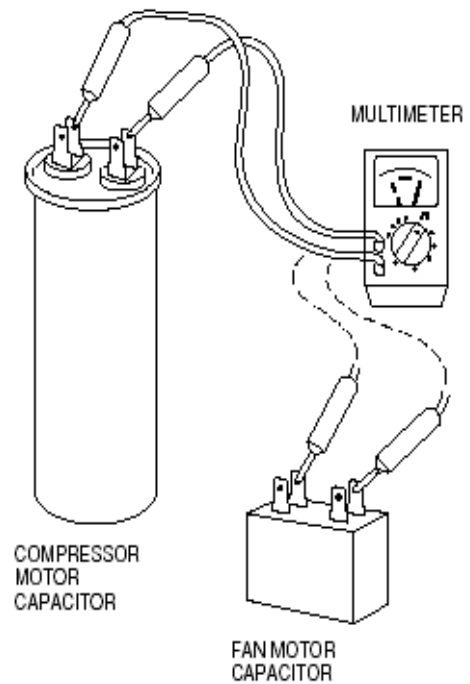

Fig. 7



0.8180.588.01 10/2012
R.D. 28 Reyrieux BP 131 - 01601 Trévoux CEDEX France
Tél. 04.74.00.92.92 - Fax 04.74.00.42.00
R.C.S. Bourg-en-Bresse B 759 200 728