



PHRT

HEAT PUMP WITH HYDRAULIC EQUIPMENT

AIR / WATER

7 to 16 KW



For terminal units and boiler overhaul applications

	Heating		Cooling
PHRT 7	6.90 kW	-	5.90 kW
PHRT 9	9.00 kW	-	7.10 kW
PHRT 12	10.70 kW / 12.70 kW *	-	8.50 kW / 9.00 kW *
PHRT 16	15.20 kW	-	11.40 kW

* single-phase / three-phase

MARKING

This product marked  conforms to the essential requirements of the Directives:

- Low voltage no. 2006/95/EC.
- Electromagnetic Compatibility no. 89/336 EEC, modified 92/31 and 93/68 EEC.



SUMMARY

1 - Application - Use	2
2 - Presentation	3
3 - Technical characteristics	4
4 - Physical characteristics	5
5 - Description	6
6 - Heating performances	7
7 - Cooling performances	8
8 - Corrections to be made when using anti-freeze	9
9 - Curves of available pressures	9
10 - Sound levels	10
11 - Accessories	10
12 - "ECH" electronic control	11

APPLIANCES FILLED WITH R 410 A

R 410 A

- R 410 A is a high-pressure refrigerant (+ 50% in relation to R 22 and R 407 C).
- The compressors approved for operation with this fluid are filled beforehand with polyalcohol oil.
Contrary to mineral oil, it is very hygroscopic: it absorbs the humidity of the ambient air very quickly. This can modify its lubricant properties and lead in time to the destruction of the compressor.

MAINTENANCE INSTRUCTIONS

- 1 - Never add oil to the appliance; the compressor is filled with polyalcohol oil, a special oil which cannot tolerate the presence of other oils.
- 2 - The instruments used for:
 - filling,
 - pressure measurements,
 - emptying under vacuum,
 - recovering the fluid,must be compatible and only used for the R 410 A fluid.
Note: the pressure taps of the refrigerating circuit are 5/16 SAE (1/2 - 20 - UNF)

3 - In the case of a new charge:

- the charge **must** be undertaken in liquid phase,
- use a balance and a dip pipe type R 410 A cylinder,
- charge the weight of R 410 A as per the value indicated on the unit's identification plate (for "split systems", refer to the installation instructions as the charge must consider the length of the connecting lines).

4 - In case of leakage, do not complete the charge: recover the remaining refrigerant for recycling and perform a total charge.

Recovery, recycling or the destruction of the fluid must be done in compliance with the laws in force in the country concerned.

5 - If the refrigerant circuit is opened, you must:

- avoid the entry of air into the circuit as much as possible,
- replace or install a drier,
- perform the "vacuum operation" at a minimum level of **0.3 mbar (static)**.

1 - APPLICATION - USE

- Chilled water or hot water generator for air conditioning or heating of rooms for **terminal unit** and **boiler overhaul** applications.

NOTE : The electronic control parameterization is factory-set for **terminal unit** and **boiler overhaul** applications.

2 - PRESENTATION

2.1 - DESCRIPTION

- | | |
|---|---|
| 1 - Sound-proofed hermetic compressor. | 11 - Pressure gauge. |
| 2 - Plate water heat exchanger. | 12 - Water inlet connector. |
| 3 - "Plate-Fin" air heat exchanger. | 13 - Water outlet connector. |
| 4 - Fan motor. | 14 - Filling / drainage of the water circuit. |
| 5 - Fan protection grille. | 15 - Air vent. |
| 6 - Electrical box. | 16 - Hole for connecting cables. |
| 7 - Microprocessor control unit display keyboard. | |
| 8 - Circulating pump. | |
| 9 - Expansion tank. | |
| 10 - Safety valve. | |

Materials:

- Copper piping.
- Painted sheet metal cabinet.
- Copper/aluminium air heat exchanger.
- Stainless steel water heat exchanger.
- Plastic grille.

PHRT 7
PHRT 9

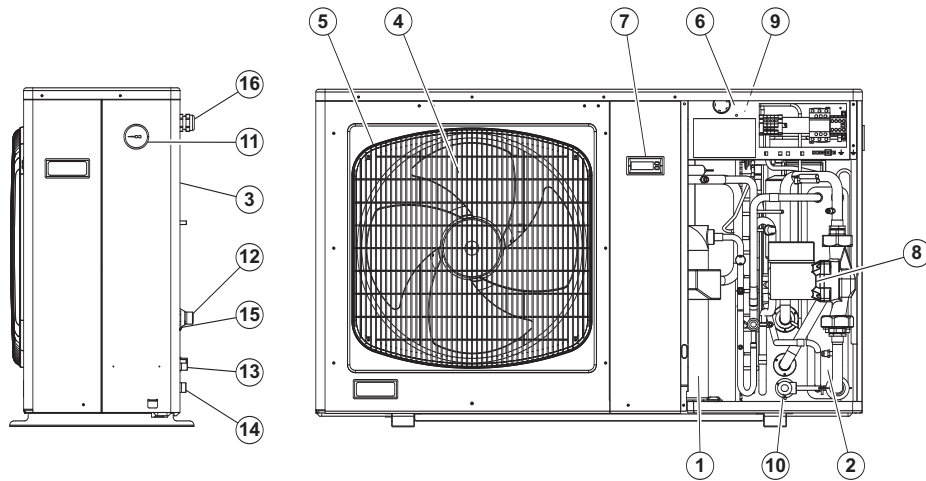

PHRT 12
PHRT 16

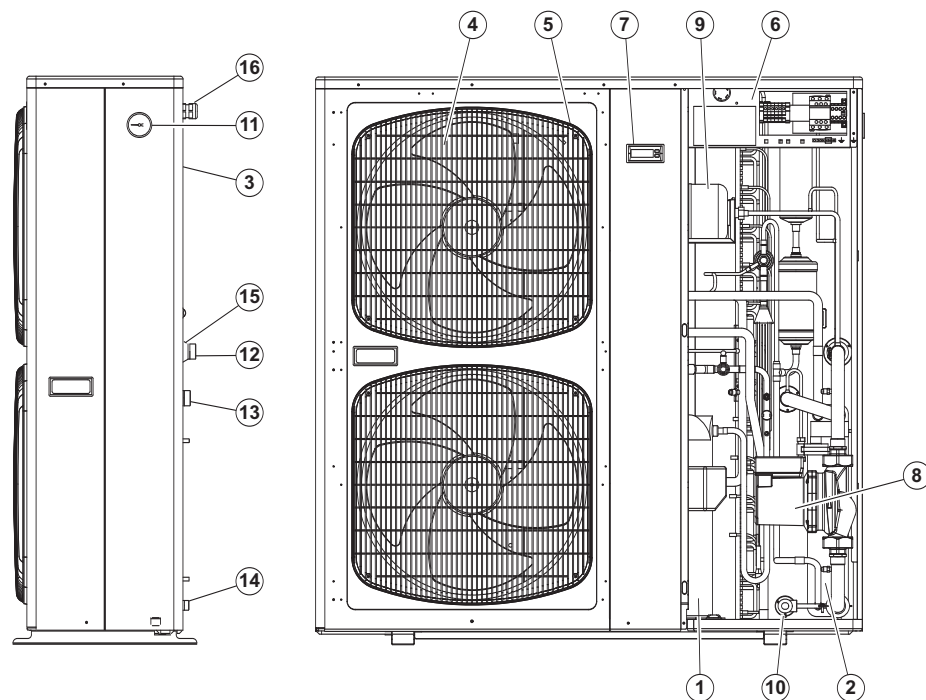

NOTE: The units are supplied with a water filter which is to be installed on the water intake.

2.2 - ELECTRICAL EQUIPMENT

- Per EN 60 335-2-40.
- "ECH" electronic control with fan speed control
- Pressure safety cutout.
- Water flow detector.
- Compressor starter with current limitation device (for single-phase units).
- Phase order controller (for three-phase units).

3 - TECHNICAL CHARACTERISTICS

Model		PHRT 7	PHRT 9	PHRT 12	PHRT 16
HEATING					
Heating capacity	kW	6.90	9.00 / 9.00	10.70 / 12.70	15.20
Nominal power consumption*	kW	2.54	3.16 / 3.10	3.48 / 3.94	4.82
Performance factor (COP)*					
Water regime 40/45°C		2.72	2.85 / 2.90	3.06 / 3.22	3.15
Water regime 30/35°C		3.48	3.63 / 3.68	3.89 / 4.00	4.05
Total Max. power consumption	1-phase kW	3.27	4.00	4.70	—
	3-phase kW	—	4.00	5.10	7.00
Total Max. current consumption	1-phase A	14.60	18.20	21.30	—
	3-phase A	—	7.20	9.00	12.70
Nominal water flow	m³/h	1.24	1.58	1.87 / 2.16	2.70
	10⁻⁴ m³/s	4.40	4.40	5.20 / 6.00	7.50
Available pressure	kPa	58.00	47.00	66.00 / 53.00	68.00
COOLING					
Cooling capacity	kW	5.90	7.10 / 7.10	8.50 / 9.00	11.40
Nominal power consumption* (EER)*	kW	2.54	3.14 / 3.09	3.31 / 3.73	4.98
		2.32	2.26 / 2.30	2.57 / 2.41	2.29
Total Max. power consumption	1-phase kW	3.27	4.00	4.70	—
	3-phase kW	—	4.00	5.10	7.00
Total Max. current consumption	1-phase A	14.60	18.20	21.30	—
	3-phase A	—	7.20	9.00	12.70
Nominal water flow	m³/h	1.02	1.22	1.48 / 1.51	1.98
	10⁻⁴ m³/s	2.80	3.40	4.10 / 4.20	5.50
Available pressure	kPa	64.00	59.00	82.00 / 80.00	84.00

(*) Gross value (without circulator)

Single-phase / three-phase

NOMINAL OPERATING CONDITIONS

HEATING

Outside air temperature (dry)	+ 7° C
Outside air temperature (humid)	+ 6° C
Water outlet temperature	+ 45° C

COOLING

Outside air temperature (dry)	+ 35° C
Water outlet temperature	+ 7° C

NOTE: Water system pressure: 1,5 to 3 bar.

OPERATING LIMITS (pure water) (*)

	PHRT 7	PHRT 9	PHRT 12	PHRT 16
HEATING				
Max. outside air temperature (humid)	+ 19° C	+ 19° C	+ 19° C	+ 19° C
Min. outside air temperature (dry) for water output temperature 55°C (max.)	+ 5° C	+ 5° C	+ 5° C	+ 5° C
Min. outside air temperature (dry) for water output temperature 50°C	- 5° C	- 5° C	- 5° C	- 5° C
Min. outside air temperature (dry) for water output temperature 45°C (nominal)	- 15° C	- 15° C	- 15° C	- 15° C
Max. water inlet temperature	+ 70° C	+ 70° C	+ 70° C	+ 70° C
Min. water outlet temperature	+ 25° C	+ 25° C	+ 25° C	+ 25° C
COOLING				
Max. outside air temperature (dry)	+ 43° C (**)	+ 43° C (**)	+ 43° C (**)	+ 43° C (**)
Min. outside air temperature (dry)	+ 10° C	+ 10° C	+ 10° C	+ 10° C
Max. water outlet temperature	+ 20° C (**)	+ 20° C (**)	+ 20° C (**)	+ 20° C (**)
Min. water outlet temperature	+ 5° C	+ 5° C	+ 5° C	+ 5° C

(*) The limits indicated are those of the machine.

(**) At 43° C outside air temperature, the max. temperature of the water outlet is limited to 18° C instead of 20° C.

4 - PHYSICAL CHARACTERISTICS

Model			PHRT 7	PHRT 9	PHRT 12	PHRT 16
Dimensions	L	mm	1,190	1,190	1,190	1,190
	H	mm	735	735	1,235	1,235
	P	mm	340	340	340	340
	Weight	kg	98	98	128	133
Dimensions packaged	L	mm	1,270	1,270	1,270	1,270
	H	mm	920	920	1,420	1,420
	P	mm	420	420	420	420
	Weight	kg	110	110	141	146

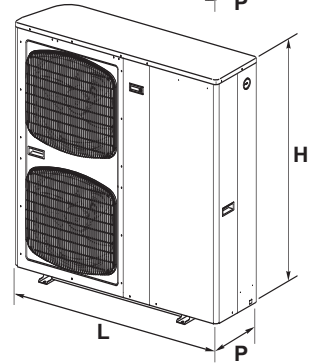
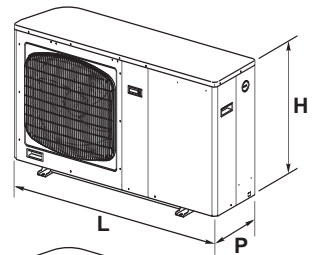
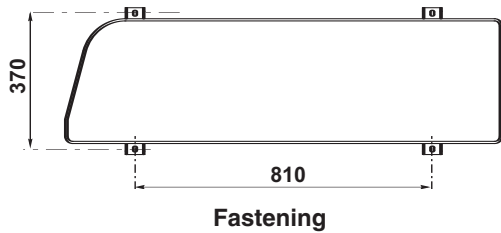

1	Water inlet connection (male) with air vent valve
2	Water outlet connection (male)
3	Water circuit fill/drain
4	Holes for electric cables

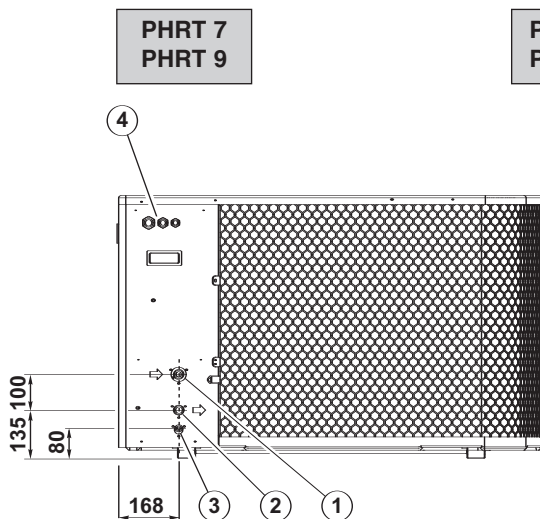

“Rear view”

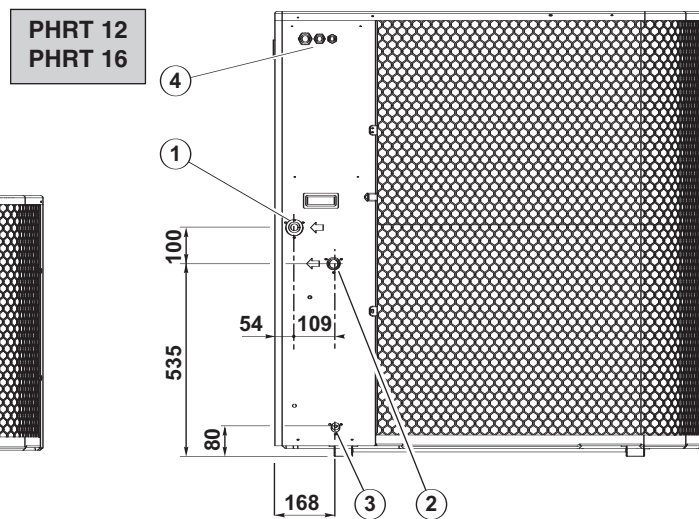

“Rear view”

5 - DESCRIPTION

Model		PHRT 7	PHRT 9	PHRT 12	PHRT 16
Hermetic compressor		Scroll	Scroll	Scroll	Scroll
with thermal protection					
Sound insulation cover		●	●	●	●
Power supply	230V/1/50Hz	●	●	●	—
	400V/3N/50Hz	—	●	●	●
Start-up current	1-phase A	40	33	34	—
	3-phase A	—	39	56	63
Direct drive propeller fan motor		1	1	2	2
with thermal protection, horizontal blowing					
Total air flow	m³/h	3,000	3,000	6,000	6,000
	m³/s	0.833	0.833	1.667	1.667
Propellor diameter	mm	460	460	460	460
Power supply	230V/1/50Hz	●	●	●	●
Rotation speed	rpm	770	770	770	770
Current	A	0.7	0.7	1.4	1.4
Power input	kW	0.140	0.140	0.280	0.280
Air exchanger		●	●	●	●
with louver fins and water-repellant treatment					
Expansion system (*)	expansion valve	●	●	●	●
Water exchanger Plate-type stainless steel water treatment section		●	●	●	●
Water capacity	liters	0.84	0.84	1.05	1.4
Expansion system (*)	expansion valve	●	●	●	●
Charged internal cooling system		1	1	1	1
with HP and LP switch					
R 410 A refrigerant Total charge 1-phase/3-phase	kg	2.05	2.1	3.5 / 3.7	3.8
Circulating pump		●	●	●	●
Current	A	0.8	0.8	1	1.3
Power input	kW	0.16	0.16	0.24	0.28
Power supply	230V/1/50Hz	●	●	●	●
Expansion tank (charge pressure 1.5 bar)		●	●	●	●
Capacity	liters	2	2	2	2
Safety valve (pressure 3 bar)		●	●	●	●
Pressure gauge (0 to 6 bar)		●	●	●	●
Air vent valve		●	●	●	●
Hydraulic system					
Male connections	inlet	3/4"	3/4"	1"	1"
	outlet	3/4"	3/4"	1"	1"
Water capacity of the unit	liters	2.3	2.3	2.8	3.2
Water flow rate detection pressure differential cut-out		●	●	●	●
Water filter supplied, uninstalled		●	●	●	●
Water volume in system					
Minimum water volume (**)	liters	30	40	50	60
Maximum water volume (***)					
Terminal unit or overhaul application	liters	90	90	90	90
Mains power supply					
Power supply	230V/1/50Hz	●	●	●	—
	400V/3N/50Hz	—	●	●	●
Equipment protection index		IP 24	IP 24	IP 24	IP 24

(*) The PHRT units are equipped with a single bi-flow regulator used for both heating and cooling operation.

(**) If the water volume of the system is below the minimum, a buffer tank must be installed.

(***) If the water volume of the system is above the maximum, an additional expansion tank is required.

6 - HEATING PERFORMANCES

HEATING CAPACITY

INPUT POWER

PHRT 7

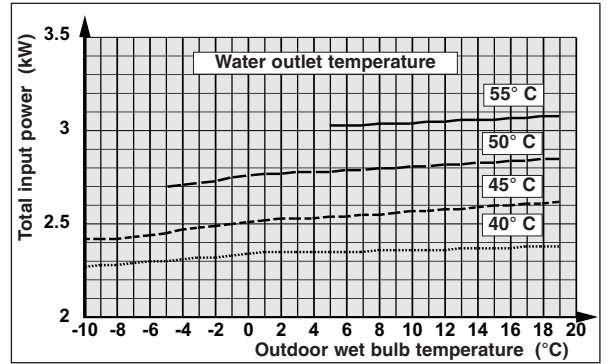
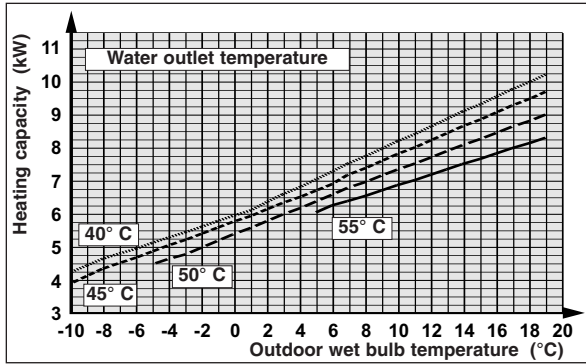

PHRT 9

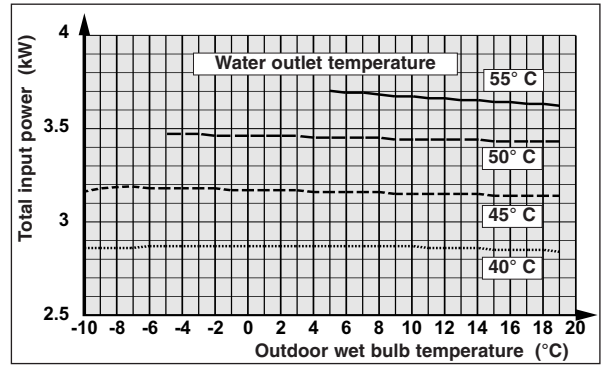
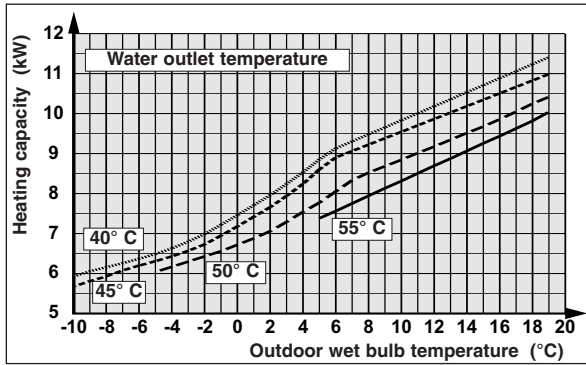

PHRT 12
mono

(single-phase)

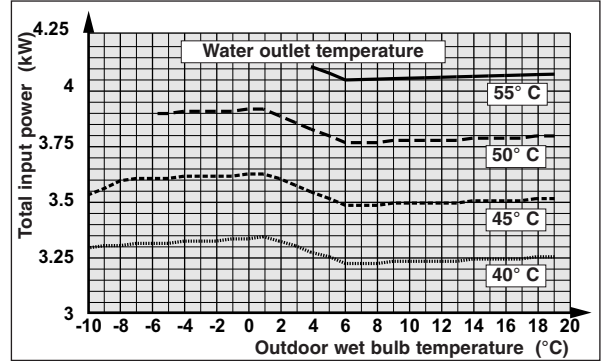
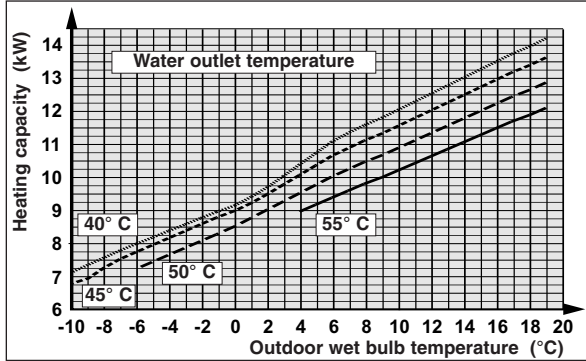

PHRT 12
tri

(three-phase)

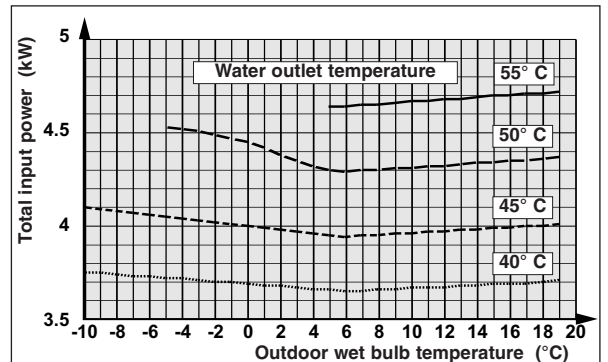
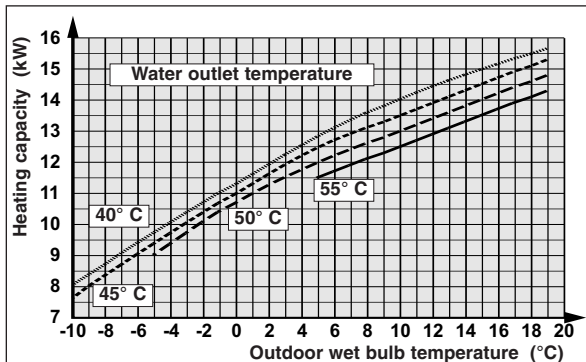

PHRT 16

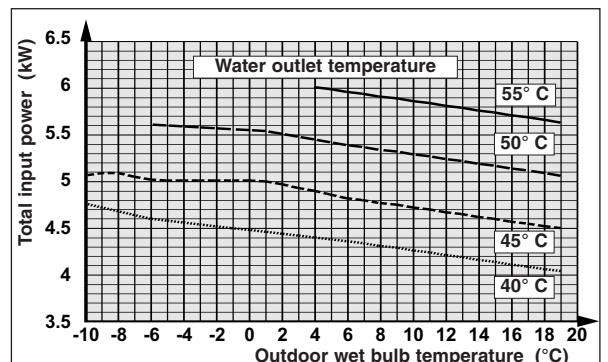
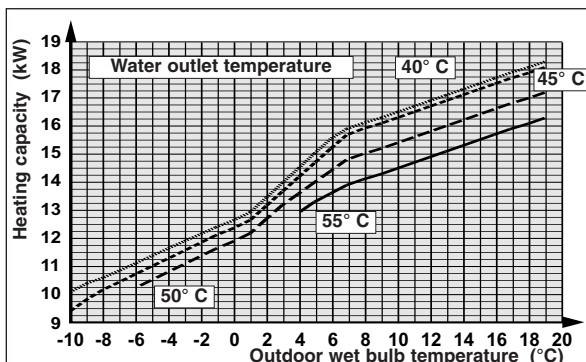

7 - COOLING PERFORMANCES

COOLING CAPACITY

INPUT POWER

PHRT 7

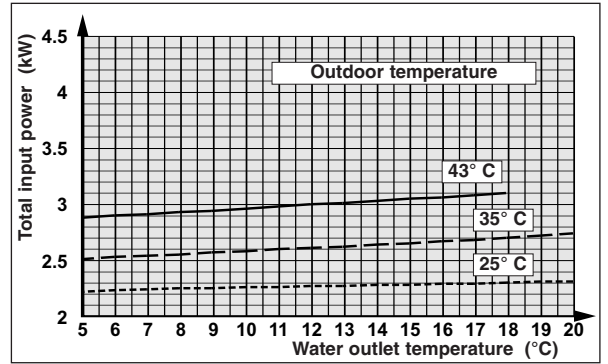
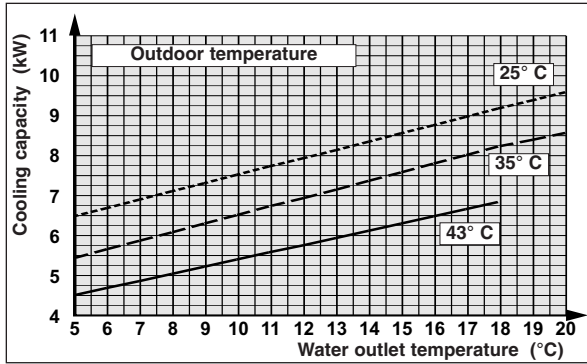

PHRT 9

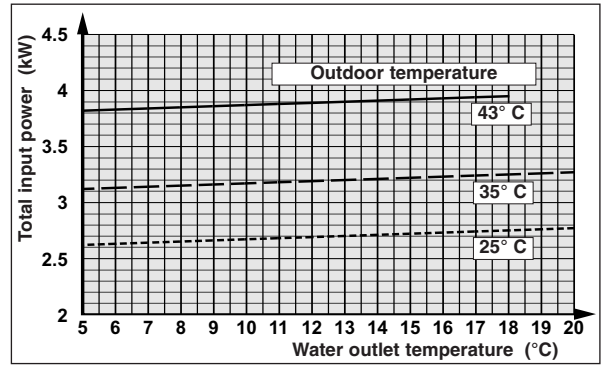
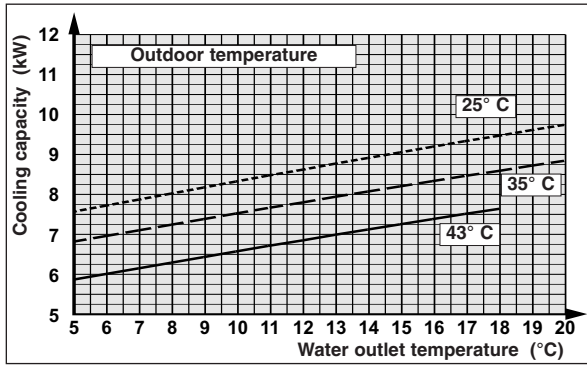

PHRT 12
mono

(single-phase)

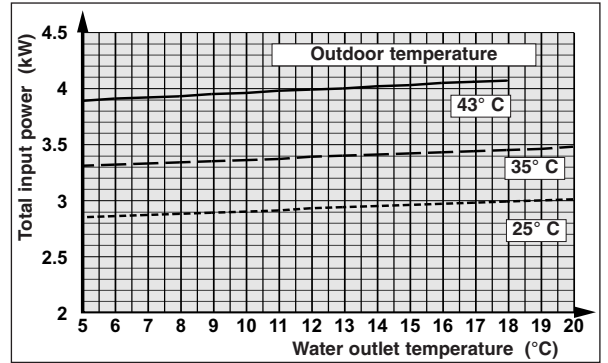
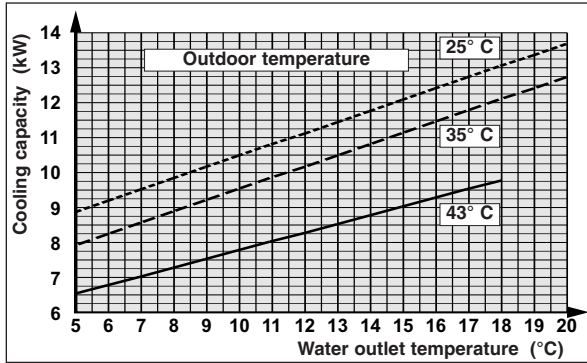

PHRT 12
tri

(three-phase)

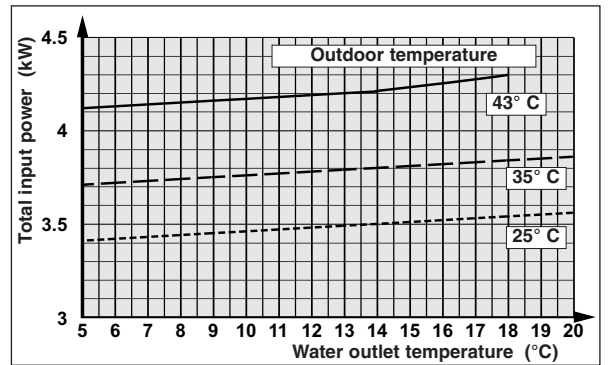
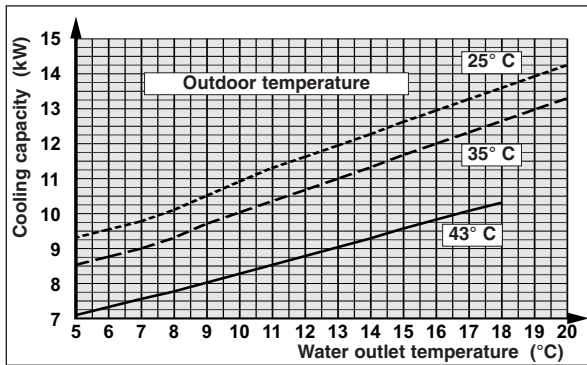

PHRT 16

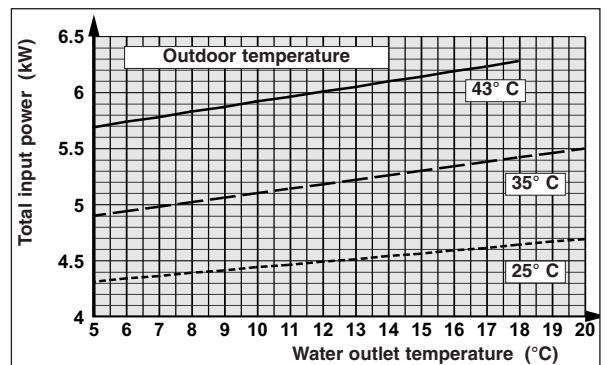
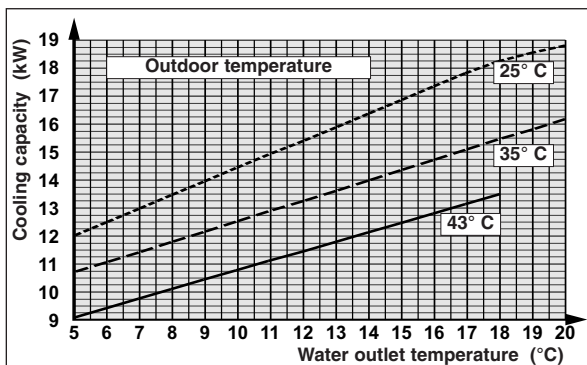

8 - CORRECTIONS TO BE MADE WHEN USING ANTI-FREEZE

(Cooling mode)

IMPORTANT:

Use monopropylene glycol.

A minimum rate of 15% to 20% is needed to avoid any risk of corrosion.

8.1 - PRINCIPLE OF USING THE CURVES

- Choose the percentage of glycol according to the minimum temperature to protect the hydraulic circuit against frost and determine the coefficients to be applied to the power, the water flow rate and the pressure drop.

8.2 - EXAMPLE

- Protection at an external temperature of -15°C , which gives 30% glycol ("Freezing points" curve).
- The "Reduction of cooling capacity" curve gives the coefficient to be applied to the refrigerating capacity (0.94).
- The "Water flow" curve gives the coefficient to be applied to the water flow rate (1.113).
- The "Pressure drop" curve gives the coefficient to be applied to the pressure drop (1.19).

Curves valid for temperature control on the water intake.

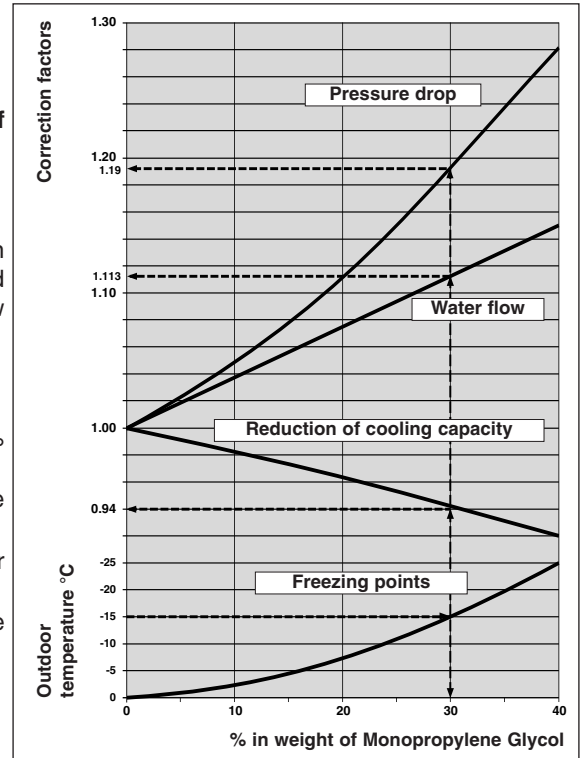

9 - CURVES OF AVAILABLE PRESSURES (on unit's outlet)

PHRT 7
PHRT 9

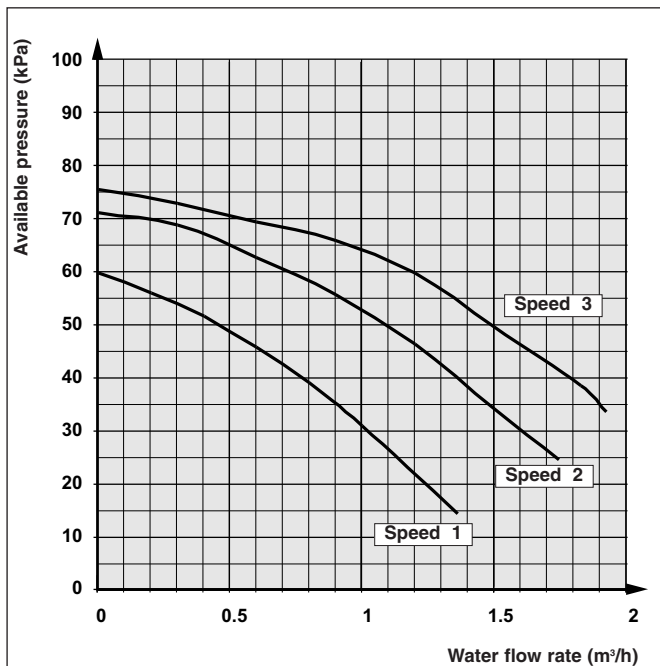

PHRT 12

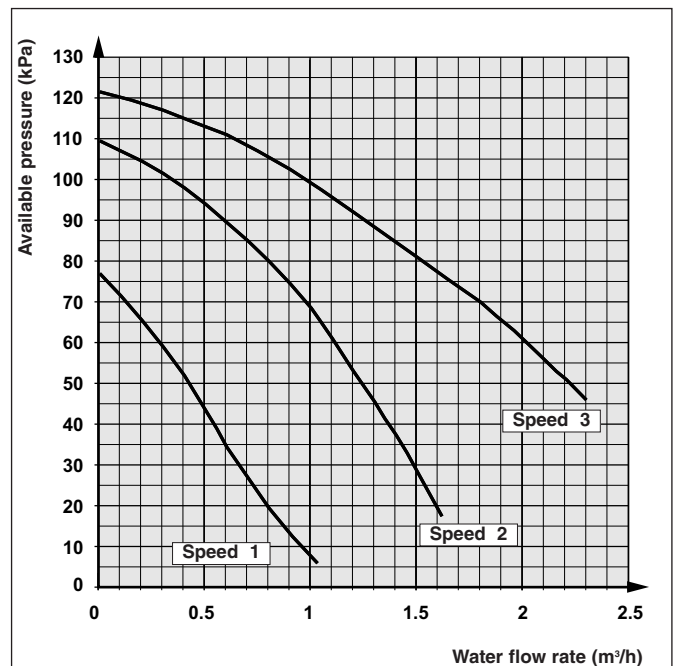

PHRT 16

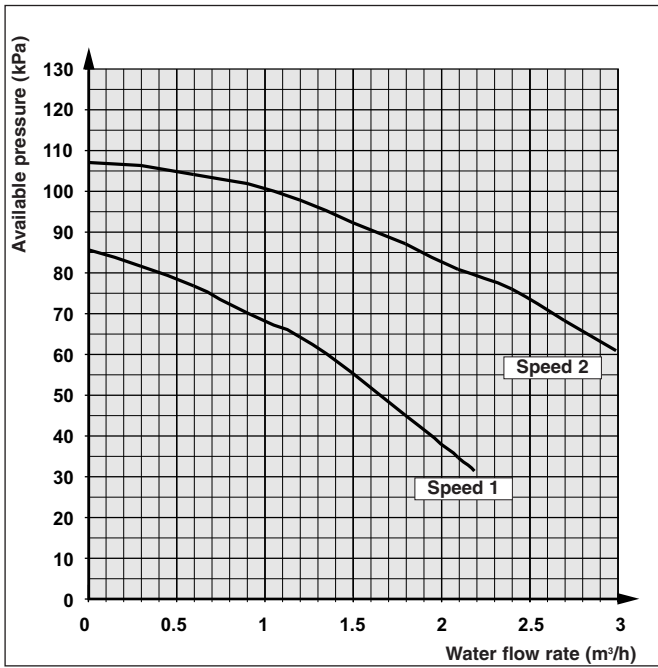

10 - SOUND LEVELS

Model	Powerlevel L _w (dBA)	Sound-pressure level L _p (dBA)
PHRT 7	65	37
PHRT 9	65	37
PHRT 12	67	39
PHRT 16	67	39

Sound-pressure level:

Unit installed outdoors (free field) on a reflective surface.
Measurement carried out at a distance of 10 m.

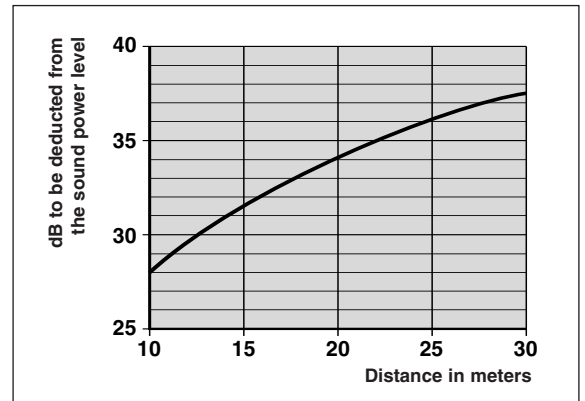

11 - ACCESSORIES

	PHRT 7	PHRT 9	PHRT 12	PHRT 16
Set of 2 flexible hoses	●	●	—	—
			●	●
	—	—	●	●
Condensate tank heating cord kit	●	●	●	●
Remote control	●	●	●	●
RS 485 communication interface (MODBUS protocol)	●	●	●	●
Insulated tank 35 liters 6 branch connection	●	●	●	●

12 - "ECH" ELECTRONIC CONTROL

- Microprocessor control module, including:
 - chilled water temperature control (water return),
 - control of operating parameters,
 - self-adapting algorithm for water volume reduction,
 - circulating pump control (frost protection and anti-sticking function),
 - anti-short cycle system,
 - hour counter compressor and circulating pump,
 - alarm management,
 - anti-freeze security (water exchanger),
 - digital display of:
 - . water temperature,
 - . set-point,
 - . alarm code (HP, LP, water output, probes, anti-freeze...).
 - remote alarm reporting is possible via a potential-free contact,
 - integrated condensation pressure control,
 - heating cord control (accessory),
 - remote control with display unit (accessory),
 - serial communications port (RS 485 interface, accessory) - MODBUS Protocol.

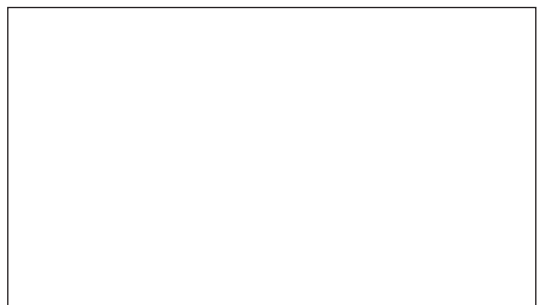

Due to our policy of continuous development, our products are liable to modification without notice.

Technibel

R.D. 28 Reyrieux BP 131 01601 Trévoux CEDEX France
Phone 33 4 74 00 92 92 - Fax 33 4 74 00 42 00
R.C.S. Bourg-en-Bresse B 759 200 728