



PHR

HEAT PUMP WITH HYDRAULIC EQUIPMENT

AIR / WATER

6 to 17 KW



For underfloor application

Heating

Cooling

PHR 6	6.80 kW	-	6.70 kW
PHR 8	8.65 kW / 8.60 kW *	-	8.70 kW / 8.50 kW *
PHR 11	11.25 kW / 11.20 kW *	-	9.45 kW / 9.50 kW *
PHR 15	14.40 kW	-	14.60 kW
PHR 17	17.00 kW	-	16.50 kW

* single-phase / three-phase

MARKING

This product marked  conforms to the essential requirements of the Directives:

- Low voltage no. 73/23 EEC, modified 93/68 EEC.
- Electromagnetic Compatibility no. 89/336 EEC, modified 92/31 and 93/68 EEC.



SUMMARY

1 - Application - Use	2
2 - Presentation	3
3 - Technical characteristics	4
4 - Physical characteristics	5
5 - Description	6
6 - Heating performances	7
7 - Cooling performances	8
8 - Corrections to be made when using anti-freeze	9
9 - Curves of available pressures	9
10 - Sound levels	10
11 - Accessories	10
12 - "ECH" electronic control	11

APPLIANCES FILLED WITH R 410 A

R 410 A

- R 410 A is a high-pressure refrigerant (+ 50% in relation to R 22 and R 407 C).
- The compressors approved for operation with this fluid are filled beforehand with polyalcohol oil.
Contrary to mineral oil, it is very hygroscopic: it absorbs the humidity of the ambient air very quickly. This can modify its lubricant properties and lead in time to the destruction of the compressor.

MAINTENANCE INSTRUCTIONS

- 1 - Never add oil to the appliance; the compressor is filled with polyalcohol oil, a special oil which cannot tolerate the presence of other oils.
- 2 - The instruments used for:
 - filling,
 - pressure measurements,
 - emptying under vacuum,
 - recovering the fluid,must be compatible and only used for the R 410 A fluid.
Note: the pressure taps of the refrigerating circuit are 5/16 SAE (1/2 - 20 - UNF)

3 - In the case of a new charge:

- the charge **must** be undertaken in liquid phase,
- use a balance and a dip pipe type R 410 A cylinder,
- charge the weight of R 410 A as per the value indicated on the unit's identification plate (for "split systems", refer to the installation instructions as the charge must consider the length of the connecting lines).

4 - In case of leakage, do not complete the charge: recover the remaining refrigerant for recycling and perform a total charge.

Recovery, recycling or the destruction of the fluid must be done in compliance with the laws in force in the country concerned.

5 - If the refrigerant circuit is opened, you must:

- avoid the entry of air into the circuit as much as possible,
- replace or install a drier,
- perform the "vacuum operation" at a minimum level of **0.3 mbar (static)**.

1 - APPLICATION - USE

- Chilled water or hot water generator for air conditioning or heating of rooms for the **floor heating / cooling** application.

NOTE: The electronic control parameterisation is factory set for a **floor** application.

2 - PRESENTATION

2.1 - DESCRIPTION

- | | |
|---|---|
| 1 - Sound-proofed hermetic compressor. | 11 - Pressure gauge. |
| 2 - Plate water heat exchanger. | 12 - Water inlet connector. |
| 3 - "Plate-Fin" air heat exchanger. | 13 - Water outlet connector. |
| 4 - Fan motor. | 14 - Filling / drainage of the water circuit. |
| 5 - Fan protection grille. | 15 - Air vent. |
| 6 - Electrical box. | 16 - Hole for connecting cables. |
| 7 - Microprocessor control unit display keyboard. | |
| 8 - Circulating pump. | |
| 9 - Expansion tank. | |
| 10 - Safety valve. | |

Materials:

- Copper piping.
- Painted sheet metal cabinet.
- Copper/aluminium air heat exchanger.
- Stainless steel water heat exchanger.
- Plastic grille.

PHR 6
PHR 8

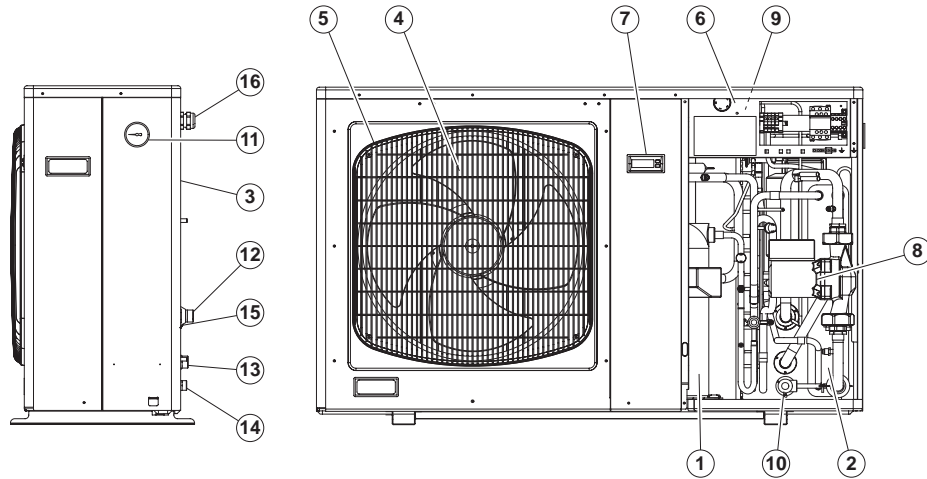

PHR 11
PHR 15
PHR 17

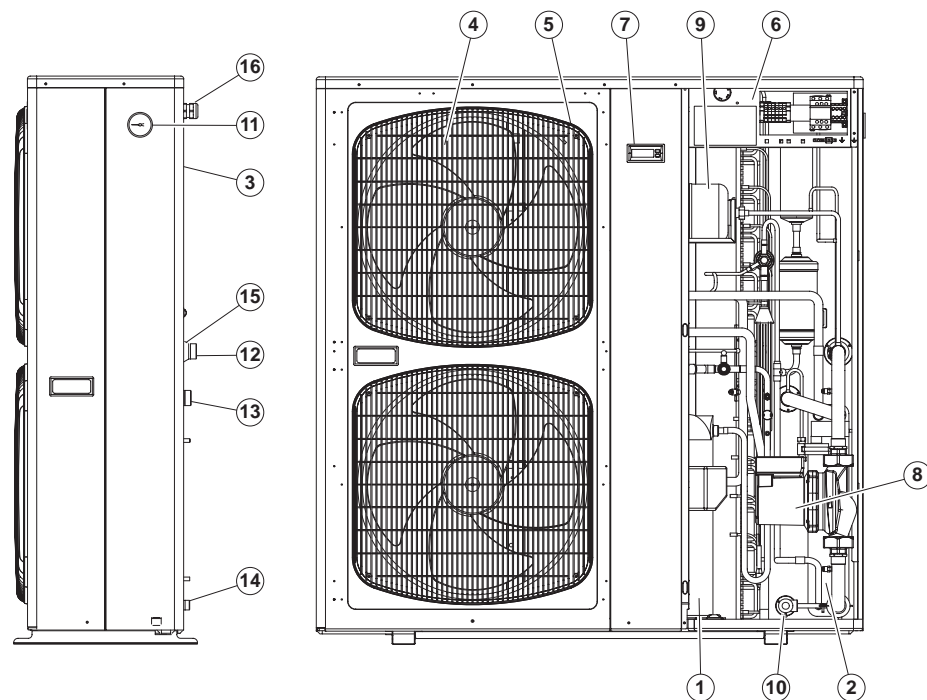

NOTE: The units are supplied with a water filter which is to be installed on the water intake.

2.2 - ELECTRICAL EQUIPMENT

- 1 "SCROLL" type compressor and its contactor (rotary type for PHR 6).
- 1 circulator and its contactor.
- 1 (or 2) electric fan(s).
- 1 HP pressure switch and 1 LP pressure switch.
- Proportional "All-season" control.
- Water flow rate detection pressure differential cut-out.
- "ECH" microprocessor control system.
- Temperature control sensor, located at the water inlet.
- **NOTE:**
 - Electrical equipment according to standard EN 60 335-2-40.

3 - TECHNICAL CHARACTERISTICS

Model		PHR 6	PHR 8	PHR 11	PHR 15	PHR 17
HEATING						
Heating capacity	kW	6.80	8.65 / 8.60	11.25 / 11.20	14.00	17.00
Nominal power consumption*	kW	1.76	2.20 / 2.10	2.70 / 2.56	3.54	4.47
Performance factor (COP)		3.86	3.93 / 4.10	4.17 / 4.38	4.07	3.80
Total Max. power consumption	1-phase kW	2.80	3.90	4.85	—	—
	3-phase kW	—	3.65	4.40	6.50	7.70
Total Max. current consumption	1-phase A	12.70	18.00	23.00	—	—
	3-phase A	—	8.00	10.00	13.00	14.00
Nominal water flow	m ³ /h	1.19	1.44	1.91	2.48	2.81
	10 ⁻⁴ m ³ /s	3.30	4.00	5.30	6.90	7.80
Available pressure	kPa	50.00	42.00	55.00	65.00	76.00
COOLING						
Cooling capacity	kW	6.70	8.70 / 8.50	9.45 / 9.50	14.60	16.50
Nominal power consumption* (EER)	kW	2.08	2.94 / 2.77	3.33 / 3.13	4.37	6.00
		3.22	2.96 / 3.07	2.84 / 3.04	3.34	2.75
Total Max. power consumption	1-phase kW	2.80	3.9	4.85	—	—
	3-phase kW	—	3.65	4.40	6.50	7.70
Total Max. current consumption	1-phase A	12.70	18.00	23.00	—	—
	3-phase A	—	8.00	10.00	13.00	14.00
Nominal water flow	m ³ /h	1.15	1.48	1.62	2.48	2.74
	10 ⁻⁴ m ³ /s	3.20	4.10	4.50	6.90	7.60
Available pressure	kPa	50.00	41.00	72.00	65.00	79.00

(*) Bare (without circulator)

Single-phase / three-phase

NOMINAL OPERATING CONDITIONS

HEATING	
Outside air temperature (dry)	+ 7°C
Outside air temperature (humid)	+ 6°C
Water outlet temperature	+ 35°C
COOLING	
Outside air temperature (dry)	+ 35°C
Water outlet temperature	+ 18°C

NOTE: Maximum water system pressure: 3 bar.

OPERATING LIMITS (pure water) (*)

	PHR 6	PHR 8	PHR 11	PHR 15	PHR 17
HEATING					
Max. outside air temperature (dry)	+ 20°C	+ 20°C	+ 20°C	+ 20°C	+ 20°C
Min. outside air temperature (dry) for a max. water output temperature (40°C)	- 10°C	- 10°C	- 10°C	- 8°C	- 8°C
Min. outside air temperature (dry) for nominal water output temperature (35°C)	- 10°C	- 15°C	- 15°C	- 15°C	- 13°C
Min. water outlet temperature	+ 25°C	+ 25°C	+ 25°C	+ 25°C	+ 25°C
COOLING					
Max. outside air temperature (dry)	+ 43°C (**)	+ 43°C (**)	+ 43°C (**)	+ 43°C (**)	+ 43°C (**)
Min. outside air temperature (dry)	0°C	0°C	- 5°C	- 3°C	- 7°C
Max. water outlet temperature	+ 25°C (**)	+ 25°C (**)	+ 25°C (**)	+ 25°C (**)	+ 25°C (**)
Min. water outlet temperature	+ 15°C	+ 15°C	+ 15°C	+ 15°C	+ 15°C

(*) The limits indicated are those of the machine.

(**) At 43° C outside air temperature, the max. temperature of the water outlet is limited to 15° C.

4 - PHYSICAL CHARACTERISTICS

Model		PHR 6	PHR 8	PHR 11	PHR 15	PHR 17
Dimensions	L	mm	1,190	1,190	1,190	1,190
	H	mm	735	735	1,235	1,235
	P	mm	340	340	340	340
	Weight	kg	82	90	113	127
Dimensions packaged	L	mm	1,270	1,270	1,270	1,270
	H	mm	900	900	1,400	1,400
	P	mm	420	420	420	420
	Weight	kg	94	102	126	140

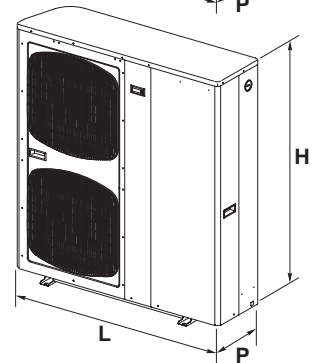
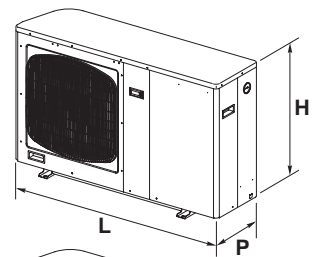
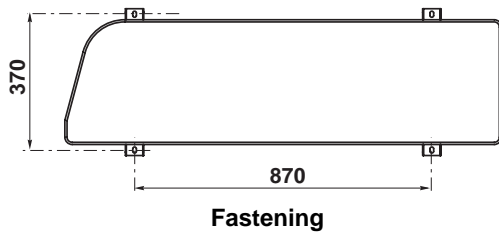

1	Water inlet connection (male) with air vent valve
2	Water outlet connection (male)
3	Water circuit fill/drain
4	Holes for electric cables

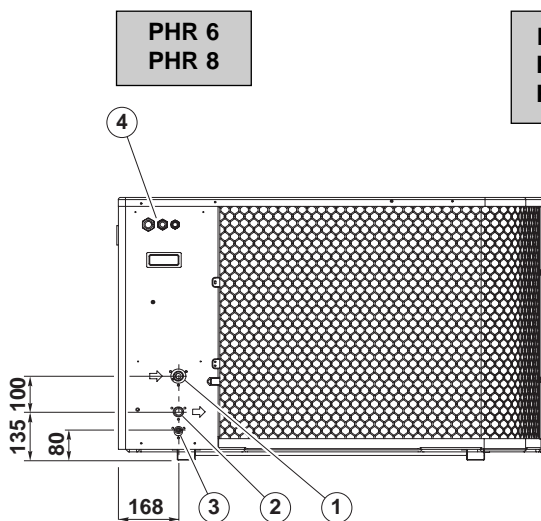

“Rear view”

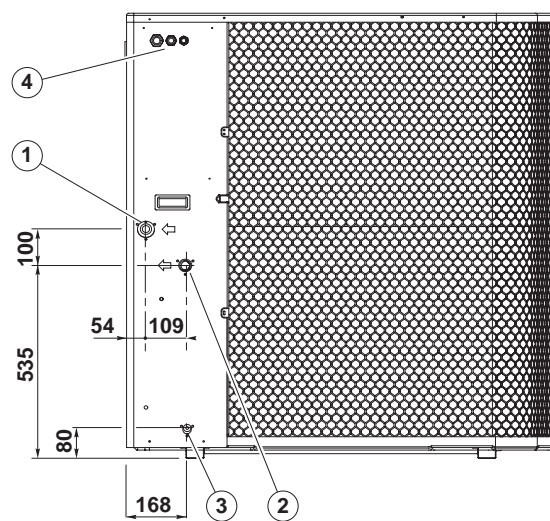

“Rear view”

5 - DESCRIPTION

Model		PHR 6	PHR 8	PHR 11	PHR 15	PHR 17	
Hermetic compressor							
with thermal protection		Rotary	Scroll	Scroll	Scroll	Scroll	
Sound insulation cover		●	●	●	●	●	
Power supply	230V/1/50Hz	●	●	●	—	—	
	400V/3N/50Hz	—	●	●	●	●	
Start-up current	1-phase A	49	82	97	—	—	
	3-phase A	—	35	48	64	74	
Start-up current with kit single-phase start-up (accessory)	A	29	44	44	—	—	
Direct drive propeller fan motor							
with thermal protection, horizontal blowing		1	1	2	2	2	
Total air flow	m ³ /h	3,000	3,000	6,000	6,000	6,000	
	m ³ /s	0.833	0.833	1.667	1.667	1.667	
Propellor diameter	mm	460	460	460	460	460	
Power supply	230V/1/50Hz	●	●	●	●	●	
Rotation speed	rpm	770	770	770	770	770	
Current	A	0.7	0.7	1.4	1.4	1.4	
Power input	kW	0.14	0.14	0.28	0.28	0.28	
Air exchanger		●	●	●	●	●	
with louver fins and water-repellant treatment							
Expansion system (*)	expansion valve	●	●	●	●	●	
Water exchanger	Plate-type stainless steel water treatment section	●	●	●	●	●	
Water capacity	liters	0.56	0.7	0.84	1.05	1.26	
Expansion system (*)	expansion valve	●	●	●	●	●	
Charged internal cooling system							
with HP and LP switch		1	1	1	1	1	
R 410 A refrigerant	Total charge	kg	1.7	1.8	3.2	3.4	3.6
Circulating pump		●	●	●	●	●	
Current	A	0.8	0.8	1	1.3	1.6	
Power input	kW	0.16	0.16	0.24	0.28	0.32	
Power supply	230V/1/50Hz	●	●	●	●	●	
Expansion tank (charge pressure 1.5 bar)		●	●	●	●	●	
Capacity	liters	2	2	2	2	2	
Safety valve (pressure 3 bar)		●	●	●	●	●	
Pressure gauge (0 to 6 bar)		●	●	●	●	●	
Air vent valve		●	●	●	●	●	
Hydraulic system							
Male connections	inlet	3/4"	3/4"	1"	1"	1"	
	outlet	3/4"	3/4"	1"	1"	1"	
Water capacity of the unit	liters	2.1	2.2	2.6	2.8	3	
Water flow rate detection pressure differential cut-out		●	●	●	●	●	
Water filter supplied, uninstalled		●	●	●	●	●	
Water volume in system							
Minimum water volume (**)	liters	45	30	40	50	60	
Maximum water volume (***)							
Floor application	liters	200	200	200	200	200	
Mains power supply							
Power supply	230V/1/50Hz	●	●	●	—	—	
	400V/3N/50Hz	—	●	●	●	●	
Equipment protection index		IP 24	IP 24	IP 24	IP 24	IP 24	

(*) The PHR 6, 8, 11 and 15 units are equipped with a single bi-flow regulator used for both heating and cooling operation. The PHR 17 is equipped with two regulators (one for heating and one for cooling)

(**) If the water volume of the system is below the minimum, a buffer tank must be installed.

(***) If the water volume of the system is above the maximum, an additional expansion tank is required.

6 - HEATING PERFORMANCES

HEATING CAPACITY

INPUT POWER

PHR 6

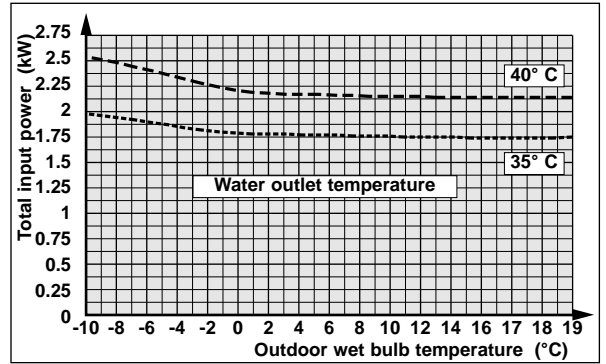
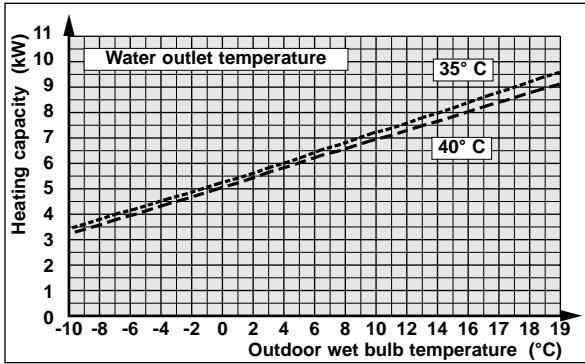

PHR 8

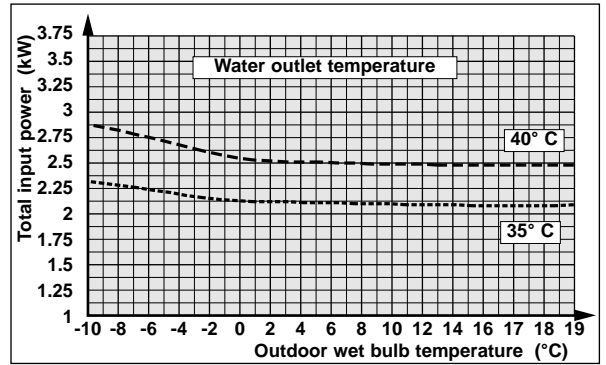
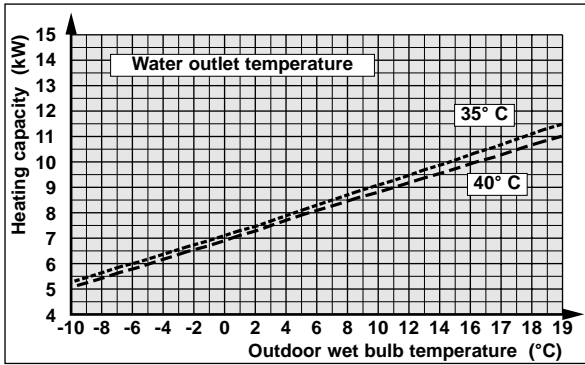

PHR 11

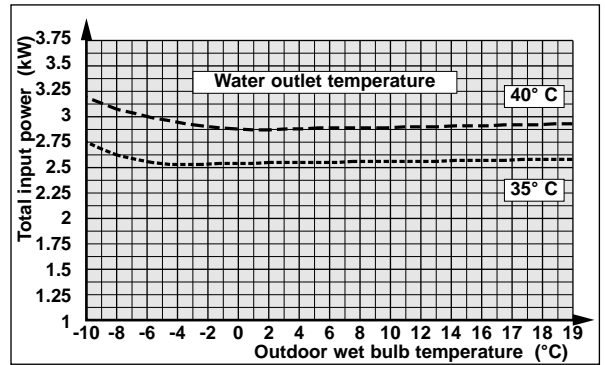
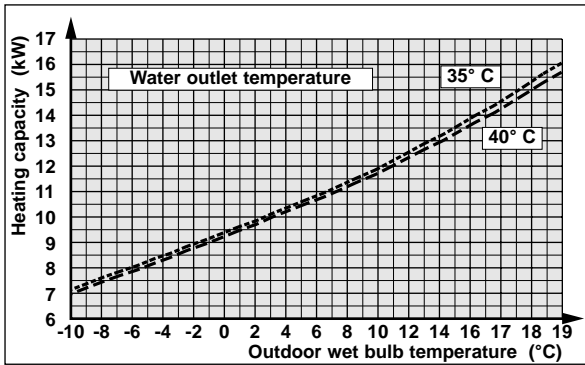

PHR 15

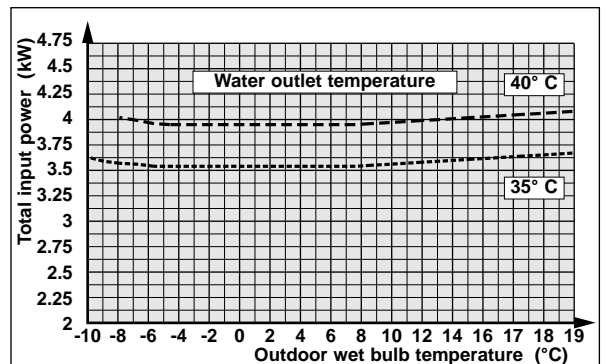
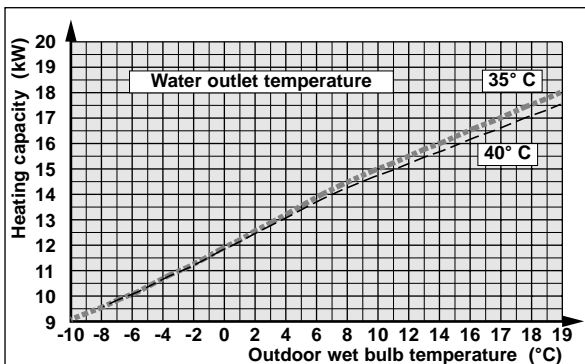

PHR 17

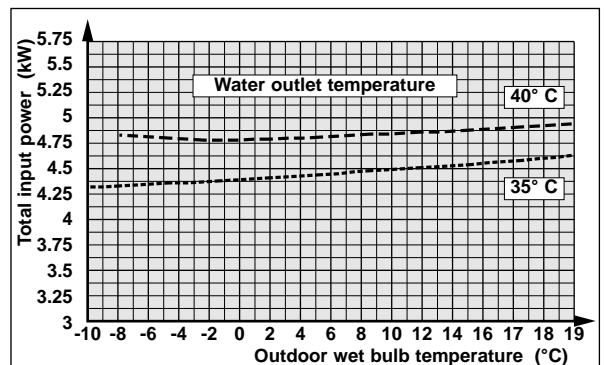
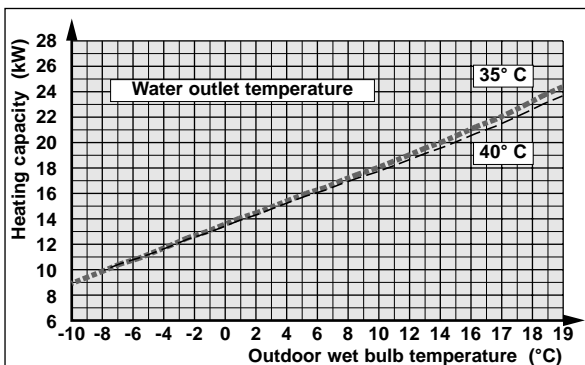

7 - COOLING PERFORMANCES

COOLING CAPACITY

INPUT POWER

PHR 6

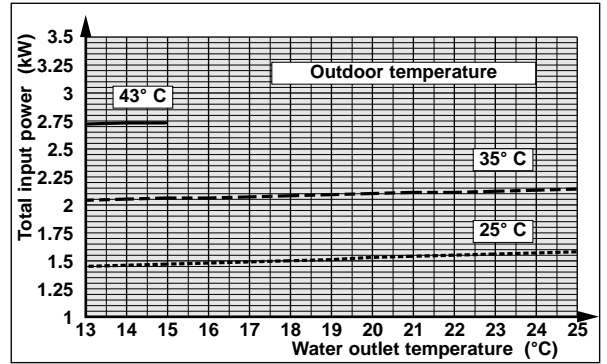
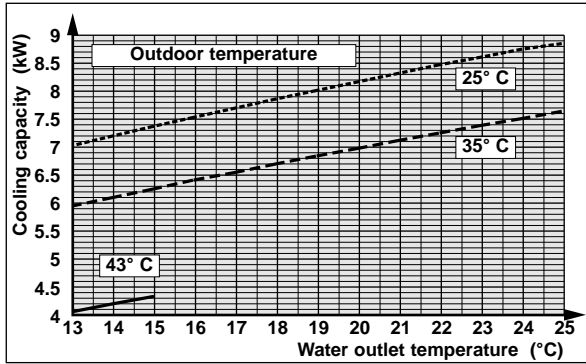

PHR 8

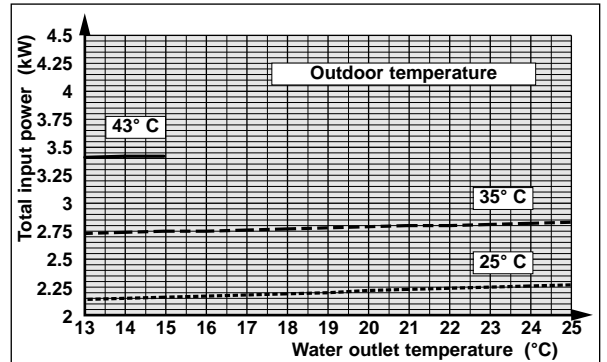
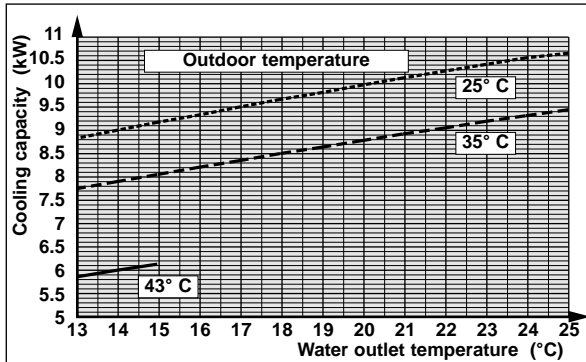

PHR 11

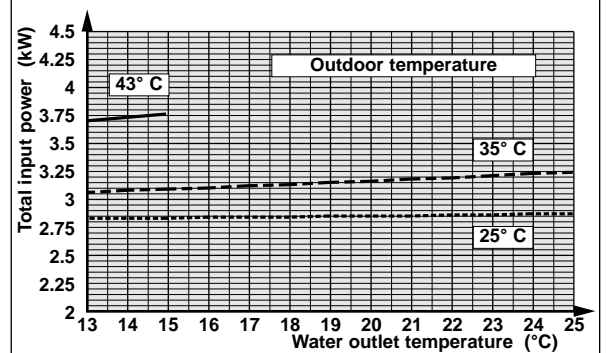
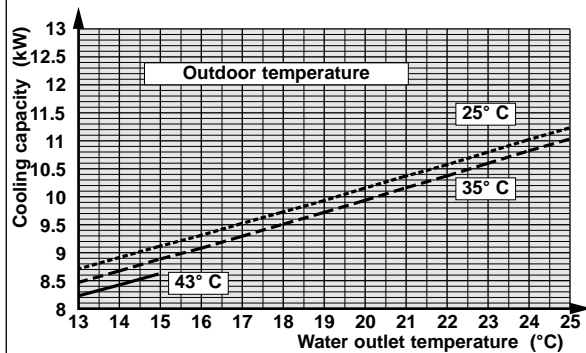

PHR 15

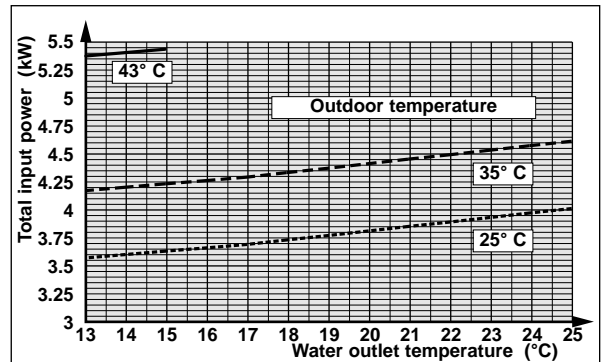
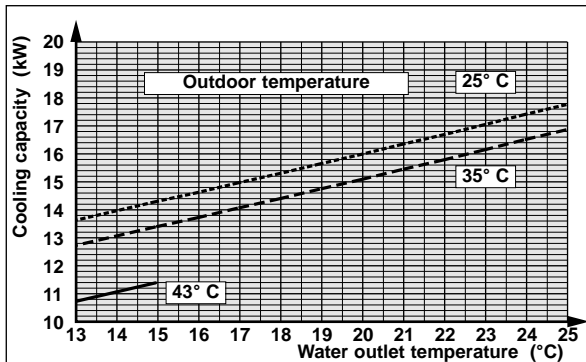

PHR 17

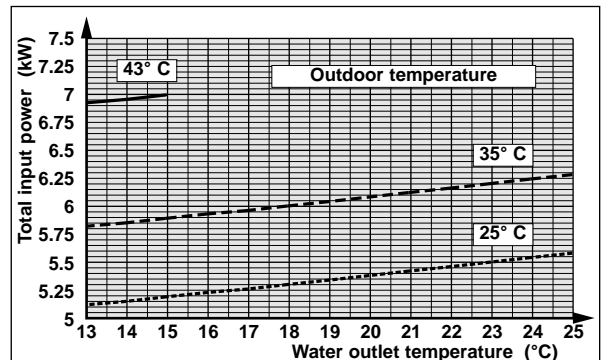
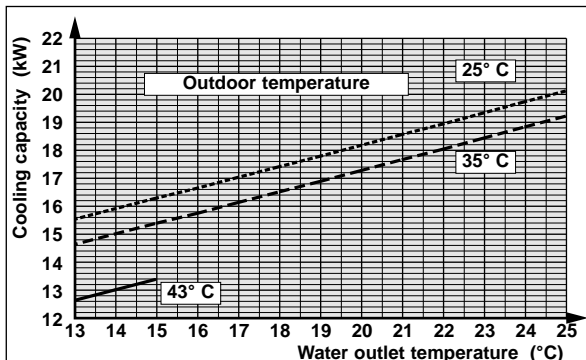

8 - CORRECTIONS TO BE MADE WHEN USING ANTI-FREEZE

(Cooling mode)

IMPORTANT:

Use monopropylene glycol.

A minimum rate of 15% to 20% is needed to avoid any risk of corrosion.

8.1 - PRINCIPLE OF USING THE CURVES

- Choose the percentage of glycol according to the minimum temperature to protect the hydraulic circuit against frost and determine the coefficients to be applied to the power, the water flow rate and the pressure drop.

8.2 - EXAMPLE

- Protection at an external temperature of -15°C, which gives 30% glycol ("Freezing points" curve).
- The "Reduction of cooling capacity" curve gives the coefficient to be applied to the refrigerating capacity (0.94).
- The "Water flow" curve gives the coefficient to be applied to the water flow rate (1.113).
- The "Pressure drop" curve gives the coefficient to be applied to the pressure drop (1.19).

Curves valid for temperature control on the water intake.

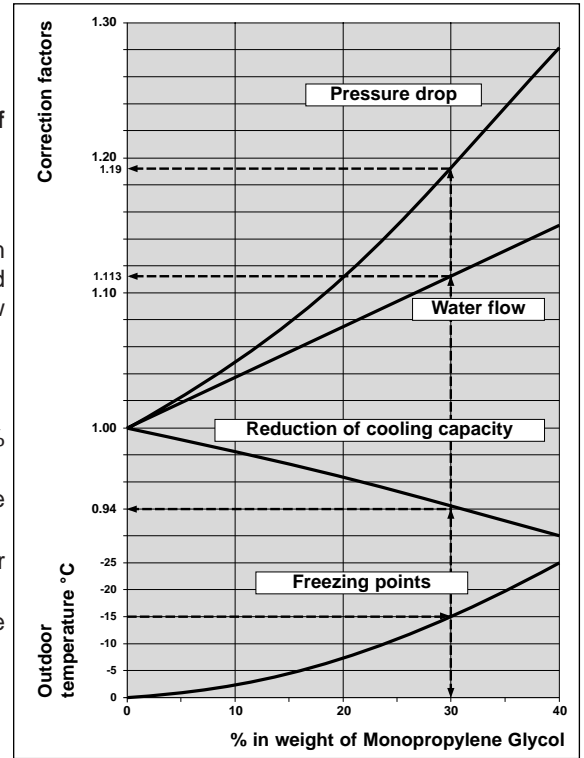

9 - CURVES OF AVAILABLE PRESSURES (on unit's outlet)

PHR 6
PHR 8

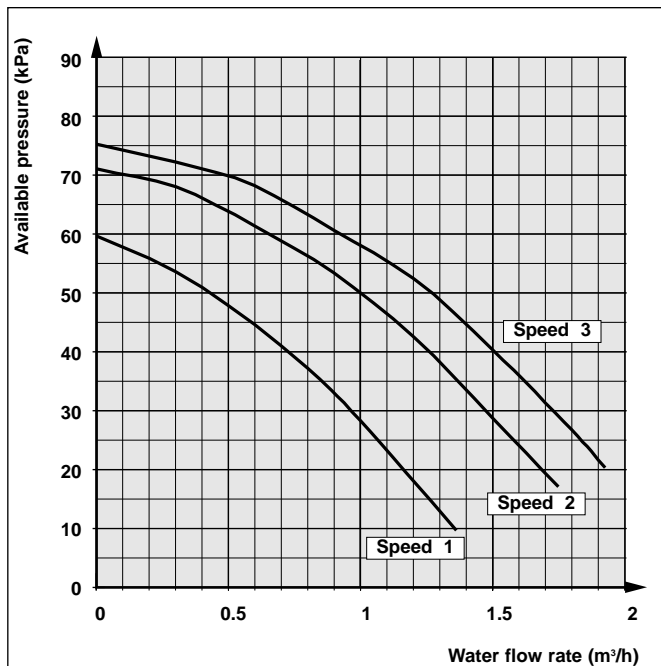

PHR 11

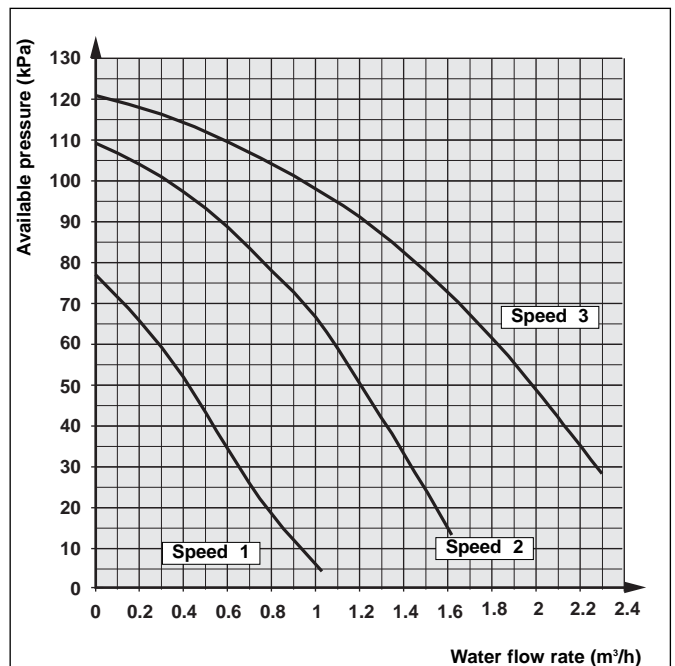

PHR 15

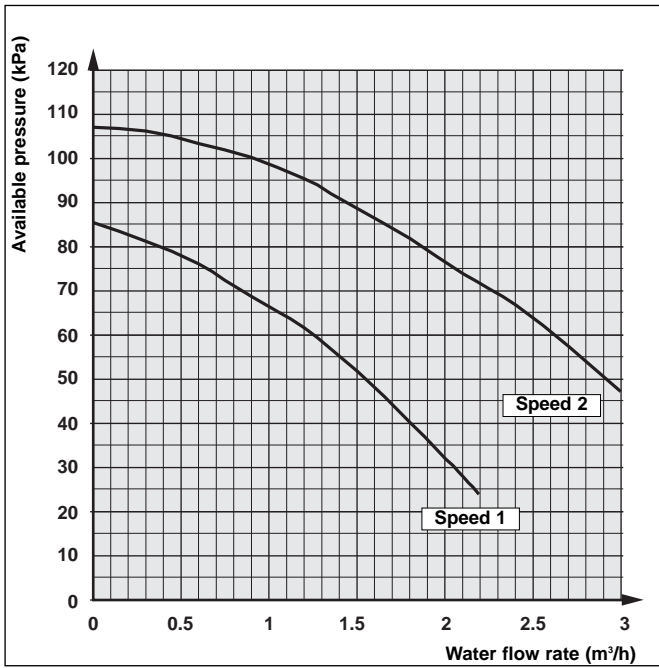

PHR 17

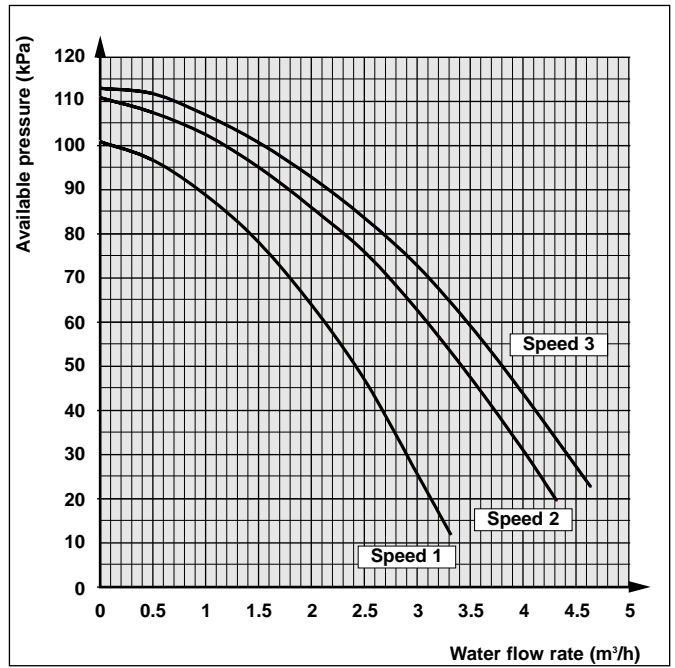

10 - SOUND LEVELS

Model	Powerlevel Lw (dBA)	Sound-pressure level Lp (dBA)
PHR 6	65	37
PHR 8	65	37
PHR 11	67	39
PHR 15	67	39
PHR 17	67	39

Sound-pressure level:

Unit installed outdoors (free field) on a reflective surface.
Measurement carried out at a distance of 10 m.



11 - ACCESSORIES

	PHR 6	PHR 8	PHR 11	PHR 15	PHR 17
Set of 2 flexible hoses	●	●	—	—	—
			●	●	●
	—	—	—	—	—
Condensate tank heating cord kit	●	●	●	●	●
Single start-up kit (for single-phase model)	●	●	●	—	—
Remote control	●	●	●	●	●
RS 485 communication interface (MODBUS protocol)	●	●	●	●	●

12 - "ECH" ELECTRONIC CONTROL

- Microprocessor control module, including:
 - chilled water temperature control (water return),
 - control of operating parameters,
 - self-adapting algorithm for water volume reduction,
 - circulating pump control (frost protection and anti-sticking function),
 - anti-short cycle system,
 - hour counter compressor and circulating pump,
 - alarm management,
 - anti-freeze security (water exchanger),
 - digital display of:
 - . water temperature,
 - . set-point,
 - . alarm code (HP, LP, water output, probes, anti-freeze...).
 - remote alarm reporting is possible via a potential-free contact,
 - integrated condensation pressure control,
 - heating cord control (accessory),
 - remote control with display unit (accessory),
 - serial communications port (RS 485 interface, accessory) - MODBUS Protocol.

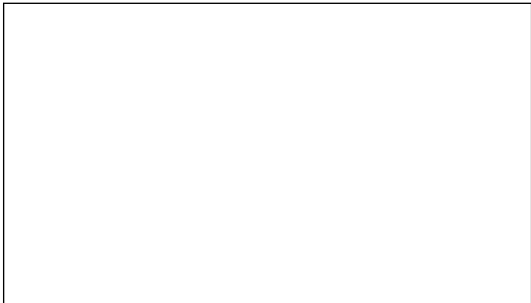

Due to our policy of continuous development, our products are liable to modification without notice.

Technibel

R.D. 28 Reyrieux BP 131 01601 Trévoux CEDEX France
Phone 33 4 74 00 92 92 - Fax 33 4 74 00 42 00
R.C.S. Bourg-en-Bresse B 759 200 728