

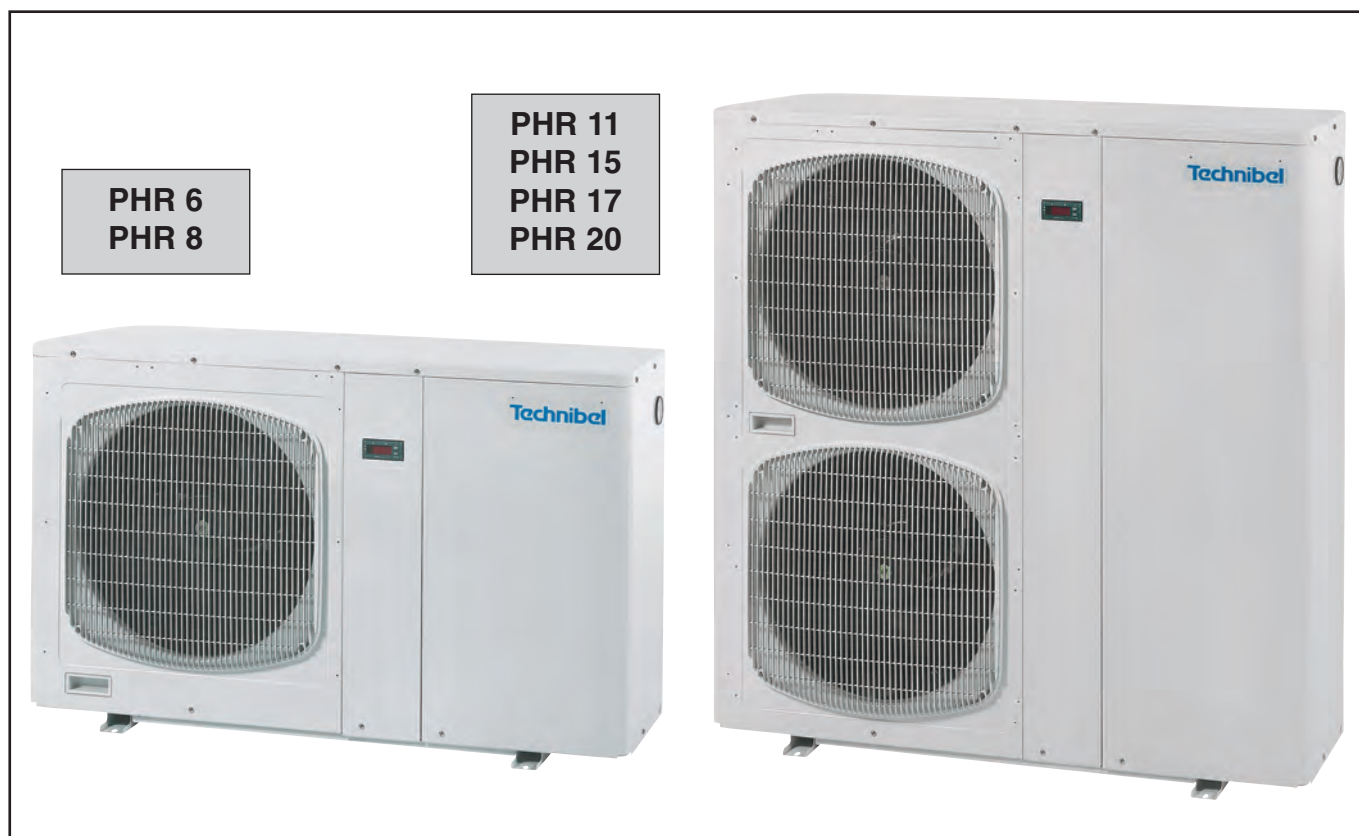

# PHR

## HEAT PUMP WITH HYDRAULIC EQUIPMENT AIR / WATER 6 to 20 KW



For underfloor application

	Heating	Cooling
PHR 6	6.80 kW	- 6.70 kW
PHR 8	8.65 kW / 8.60 kW *	- 8.70 kW / 8.50 kW *
PHR 11	11.25 kW / 11.20 kW *	- 9.45 kW / 9.50 kW *
PHR 15	14.40 kW	- 14.60 kW
PHR 17	17.00 kW	- 16.50 kW
PHR 20	20.50 kW	- 21.50 kW

\* single-phase / three-phase

## MARKING

This product marked  conforms to the essential requirements of the Directives:

- Low voltage no. 2006/95/EC.
- Electromagnetic Compatibility no. 89/336 EEC, modified 92/31 and 93/68 EEC.



## SUMMARY

1 - Application - Use	2
2 - Presentation	3
3 - Technical characteristics	4
4 - Physical characteristics	5
5 - Description	6
6 - Heating performances	7
7 - Cooling performances	8
8 - Corrections to be made when using anti-freeze	9
9 - Curves of available pressures	10
10 - Sound levels	11
11 - Accessories	11
12 - "ECH" electronic control	12

### APPLIANCES FILLED WITH R 410 A

#### R 410 A

- R 410 A is a high-pressure refrigerant (+ 50% in relation to R 22 and R 407 C).
- The compressors approved for operation with this fluid are filled beforehand with polyalcohol oil.  
Contrary to mineral oil, it is very hygroscopic: it absorbs the humidity of the ambient air very quickly. This can modify its lubricant properties and lead in time to the destruction of the compressor.

#### MAINTENANCE INSTRUCTIONS

- 1 - Never add oil to the appliance; the compressor is filled with polyalcohol oil, a special oil which cannot tolerate the presence of other oils.
- 2 - The instruments used for:
  - filling,
  - pressure measurements,
  - emptying under vacuum,
  - recovering the fluid,must be compatible and only used for the R 410 A fluid.  
Note: the pressure taps of the refrigerating circuit are 5/16 SAE (1/2 - 20 - UNF)

#### 3 - In the case of a new charge:

- the charge **must** be undertaken in liquid phase,
- use a balance and a dip pipe type R 410 A cylinder,
- charge the weight of R 410 A as per the value indicated on the unit's identification plate (for "split systems", refer to the installation instructions as the charge must consider the length of the connecting lines).

#### 4 - In case of leakage, do not complete the charge: recover the remaining refrigerant for recycling and perform a total charge.

Recovery, recycling or the destruction of the fluid must be done in compliance with the laws in force in the country concerned.

#### 5 - If the refrigerant circuit is opened, you must:

- avoid the entry of air into the circuit as much as possible,
- replace or install a drier,
- perform the "vacuum operation" at a minimum level of **0.3 mbar (static)**.

## 1 - APPLICATION - USE

- Chilled water or hot water generator for air conditioning or heating of rooms for the **floor heating / cooling** application.

**NOTE:** The electronic control parameterisation is factory set for a **floor** application.

## 2 - PRESENTATION

### 2.1 - DESCRIPTION

- |   |   |
|---|---|
| 1 - Sound-proofed hermetic compressor.            | 11 - Pressure gauge.                          |
| 2 - Plate water heat exchanger.                   | 12 - Water inlet connector.                   |
| 3 - "Plate-Fin" air heat exchanger.               | 13 - Water outlet connector.                  |
| 4 - Fan motor.                                    | 14 - Filling / drainage of the water circuit. |
| 5 - Fan protection grille.                        | 15 - Air vent.                                |
| 6 - Electrical box.                               | 16 - Hole for connecting cables.              |
| 7 - Microprocessor control unit display keyboard. |   |
| 8 - Circulating pump.                             |   |
| 9 - Expansion tank.                               |   |
| 10 - Safety valve.                                |   |

#### Materials:

- Copper piping.
- Painted sheet metal cabinet.
- Copper/aluminium air heat exchanger.
- Stainless steel water heat exchanger.
- Plastic grille.

PHR 6  
PHR 8

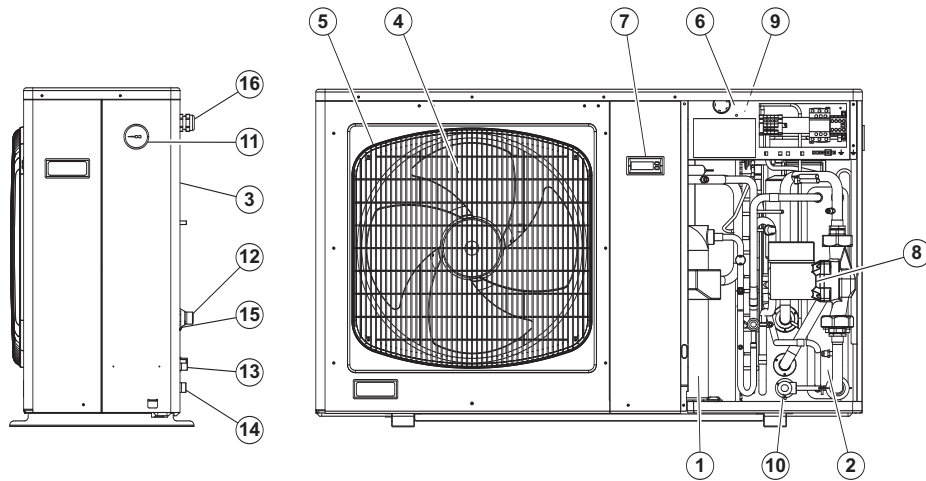

PHR 11  
PHR 15  
PHR 17  
PHR 20

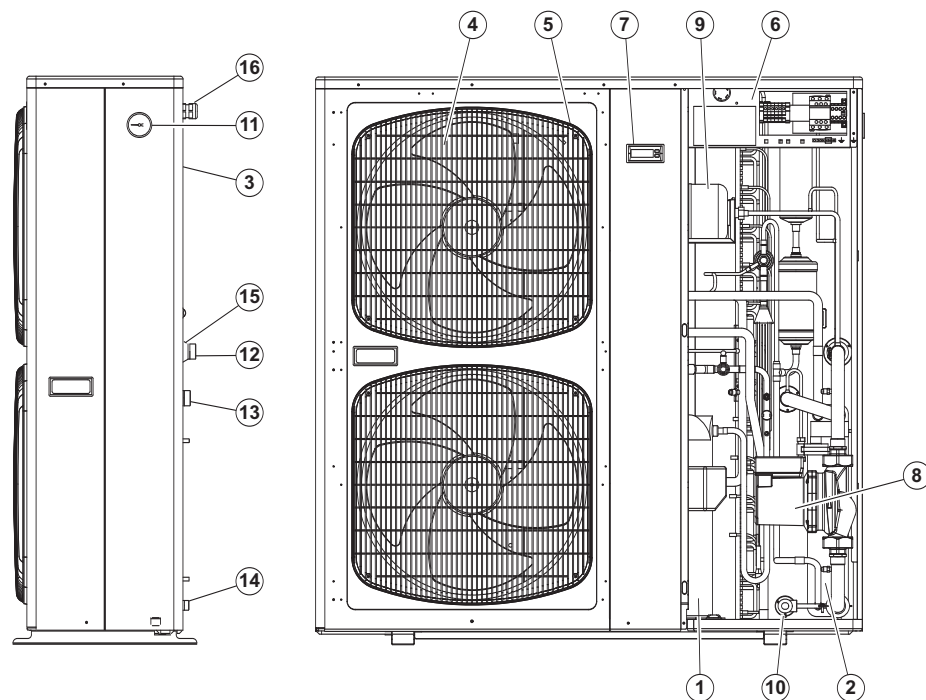

**NOTE:** The units are supplied with a water filter which is to be installed on the water intake.

### 2.2 - ELECTRICAL EQUIPMENT

- Per EN 60 335-2-40.
- "ECH" electronic control with fan speed control
- Pressure safety cutout.
- Water flow detector.
- Compressor starter with current limitation device (for single-phase units).

### 3 - TECHNICAL CHARACTERISTICS

Model		PHR 6	PHR 8	PHR 11	PHR 15	PHR 17	PHR 20
<b>HEATING</b>							
Heating capacity	<b>kW</b>	6.80	8.65 / 8.60	11.25 / 11.20	14.40	17.00	20.50
Nominal power consumption*	<b>kW</b>	1.76	2.20 / 2.10	2.70 / 2.56	3.54	4.47	5.39
Performance factor (COP)*		3.86	3.93 / 4.10	4.17 / 4.38	4.07	3.80	3.80
Total Max. power consumption	1-phase <b>kW</b>	2.80	3.90	4.85	—	—	—
	3-phase <b>kW</b>	—	3.65	4.40	6.50	7.70	9.20
Total Max. current consumption	1-phase <b>A</b>	12.70	18.00	23.00	—	—	—
	3-phase <b>A</b>	—	8.00	10.00	13.00	14.00	18.00
Nominal water flow	<b>m<sup>3</sup>/h</b>	1.19	1.44	1.91	2.48	2.81	3.56
	<b>10<sup>-4</sup> m<sup>3</sup>/s</b>	3.30	4.00	5.30	6.90	7.80	9.90
Available pressure	<b>kPa</b>	50.00	42.00	55.00	65.00	76.00	53.00
<b>COOLING</b>							
Cooling capacity	<b>kW</b>	6.70	8.70 / 8.50	9.45 / 9.50	14.60	16.50	21.50
Nominal power consumption* (EER)*	<b>kW</b>	2.08	2.94 / 2.77	3.33 / 3.13	4.37	6.00	7.41
		3.22	2.96 / 3.07	2.84 / 3.04	3.34	2.75	2.90
Total Max. power consumption	1-phase <b>kW</b>	2.80	3.9	4.85	—	—	—
	3-phase <b>kW</b>	—	3.65	4.40	6.50	7.70	9.20
Total Max. current consumption	1-phase <b>A</b>	12.70	18.00	23.00	—	—	—
	3-phase <b>A</b>	—	8.00	10.00	13.00	14.00	18.00
Nominal water flow	<b>m<sup>3</sup>/h</b>	1.15	1.48	1.62	2.48	2.74	3.71
	<b>10<sup>-4</sup> m<sup>3</sup>/s</b>	3.20	4.10	4.50	6.90	7.60	10.30
Available pressure	<b>kPa</b>	50.00	41.00	72.00	65.00	79.00	49.00

(\*) Gross value (without circulator)

Single-phase / three-phase

#### NOMINAL OPERATING CONDITIONS

<b>HEATING</b>	
Outside air temperature (dry)	+ 7° C
Outside air temperature (humid)	+ 6° C
Water outlet temperature	+35° C
<b>COOLING</b>	
Outside air temperature (dry)	+35° C
Water outlet temperature	+18° C

**NOTE:** Water system pressure: 1.5 to 3 bar.

#### OPERATING LIMITS (pure water) (\*)

	PHR 6	PHR 8	PHR 11	PHR 15	PHR 17	PHR 20
<b>HEATING</b>						
Max. outside air temperature (humid)	+ 19° C	+ 19° C	+ 19° C	+ 19° C	+ 19° C	+ 19° C
Min. outside air temperature for a max. water output temperature (40°C)	- 10° C	- 10° C	- 10° C	- 8° C	- 8° C	- 10° C
Min. outside air temperature for nominal water output temperature (35°C)	- 15° C	- 15° C	- 15° C	- 15° C	- 15° C	- 15° C
Min. water outlet temperature	+ 25° C	+ 25° C	+ 25° C	+ 25° C	+ 25° C	+ 25° C
<b>COOLING</b>						
Max. outside air temperature (dry)	+ 43° C (**)	+ 43° C (**)	+ 43° C (**)	+ 43° C (**)	+ 43° C (**)	+ 43° C (**)
Min. outside air temperature (dry)	0° C	0° C	0° C	- 3° C (***)	- 7° C	+ 10° C
Max. water outlet temperature	+ 25° C (**)	+ 25° C (**)	+ 25° C (**)	+ 25° C (**)	+ 25° C (**)	+ 25° C (**)
Min. water output temperature (Floor application control)	+ 13° C	+ 13° C	+ 13° C	+ 13° C	+ 13° C	+ 13° C
Min. water output temperature (with control parameter modification)	+ 5° C	+ 5° C	+ 5° C	+ 5° C	+ 5° C	+ 5° C

(\*) The limits indicated are those of the machine.

(\*\*) At 43° C outside air temperature, the max. temperature of the water outlet is limited to 18° C instead of 25° C.

(\*\*\*) At -3° C outside air temperature, the min. temperature of the water outlet is limited to 10° C instead of 5° C.

## 4 - PHYSICAL CHARACTERISTICS

Model			PHR 6	PHR 8	PHR 11	PHR 15	PHR 17	PHR 20
Dimensions	L	mm	1,190	1,190	1,190	1,190	1,190	1,190
	H	mm	735	735	1,235	1,235	1,235	1,235
	P	mm	340	340	340	340	340	340
	Weight	kg	82	90	113	127	131	138
Dimensions packaged	L	mm	1,270	1,270	1,270	1,270	1,270	1,270
	H	mm	920	920	1,420	1,420	1,420	1,420
	P	mm	420	420	420	420	420	420
	Weight	kg	94	102	126	140	144	151

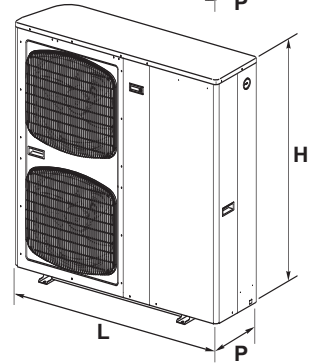
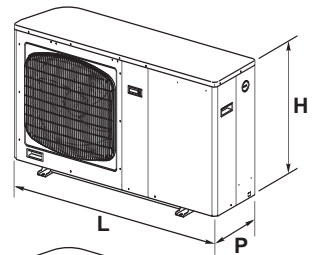
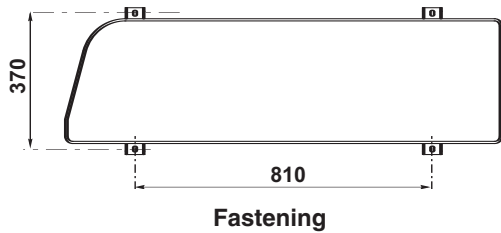

1	Water inlet connection (male) with air vent valve
2	Water outlet connection (male)
3	Water circuit fill/drain
4	Holes for electric cables

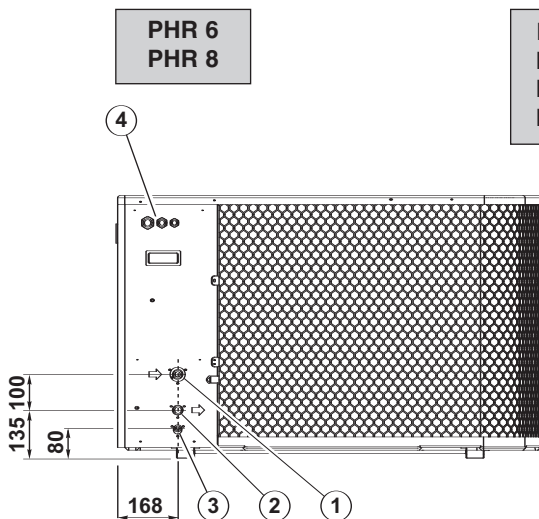

“Rear view”

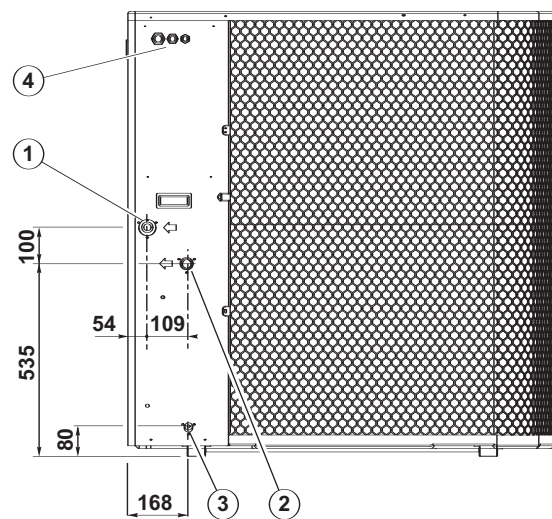

“Rear view”

## 5 - DESCRIPTION

Model		PHR 6	PHR 8	PHR 11	PHR 15	PHR 17	PHR 20
<b>Hermetic compressor</b>		<b>Rotary</b>	<b>Scroll</b>	<b>Scroll</b>	<b>Scroll</b>	<b>Scroll</b>	<b>Scroll</b>
with thermal protection							
Sound insulation cover		●	●	●	●	●	●
Power supply	<b>230V/1/50Hz</b>	●	●	●	—	—	—
	<b>400V/3N/50Hz</b>	—	●	●	●	●	●
Start-up current	<b>1-phase A</b>	29	32	36	—	—	—
	<b>3-phase A</b>	—	35	48	64	74	101
<b>Direct drive propeller fan motor</b>		1	1	2	2	2	2
with thermal protection, horizontal blowing							
Total air flow	<b>m³/h</b>	3,000	3,000	6,000	6,000	6,000	7,700
	<b>m³/s</b>	0.833	0.833	1.667	1.667	1.667	2.139
Propellor diameter	<b>mm</b>	460	460	460	460	460	460
Power supply	<b>230V/1/50Hz</b>	●	●	●	●	●	●
Rotation speed	<b>rpm</b>	770	770	770	770	770	1,090
Current	<b>A</b>	0.7	0.7	1.4	1.4	1.4	2.7
Power input	<b>kW</b>	0.14	0.14	0.28	0.28	0.28	0.62
<b>Air exchanger</b>		●	●	●	●	●	●
with louver fins and water-repellant treatment							
Expansion system (*)	<b>expansion valve</b>	●	●	●	●	●	●
<b>Water exchanger</b>	Plate-type stainless steel water treatment section	●	●	●	●	●	●
Water capacity	<b>liters</b>	0.56	0.7	0.84	1.05	1.26	1.61
Expansion system (*)	<b>expansion valve</b>	●	●	●	●	●	●
<b>Charged internal cooling system</b>		1	1	1	1	1	1
with HP and LP switch							
<b>R 410 A refrigerant</b>	Total charge	<b>kg</b>	1.7	1.8	3.2	3.4	3.5
<b>Circulating pump</b>		●	●	●	●	●	●
Current	<b>A</b>	0.8	0.8	1	1.3	1.6	1.6
Power input	<b>kW</b>	0.16	0.16	0.24	0.28	0.32	0.32
Power supply	<b>230V/1/50Hz</b>	●	●	●	●	●	●
<b>Expansion tank</b> (charge pressure 1.5 bar)		●	●	●	●	●	●
Capacity	<b>liters</b>	2	2	2	2	2	2
<b>Safety valve</b> (pressure 3 bar)		●	●	●	●	●	●
<b>Pressure gauge</b> (0 to 6 bar)		●	●	●	●	●	●
<b>Air vent valve</b>		●	●	●	●	●	●
<b>Hydraulic system</b>							
Male connections	<b>inlet</b>	3/4"	3/4"	1"	1"	1"	1"
	<b>outlet</b>	3/4"	3/4"	1"	1"	1"	1"
Water capacity of the unit	<b>liters</b>	2.1	2.2	2.6	2.8	3	3.4
Water flow rate detection pressure differential cut-out		●	●	●	●	●	●
Water filter supplied, uninstalled		●	●	●	●	●	●
<b>Water volume in system</b>							
Minimum water volume (**)	<b>liters</b>	45	30	40	50	60	60
Maximum water volume (***)							
Floor application	<b>liters</b>	200	200	200	200	200	200
<b>Mains power supply</b>							
Power supply	<b>230V/1/50Hz</b>	●	●	●	—	—	—
	<b>400V/3N/50Hz</b>	—	●	●	●	●	●
<b>Equipment protection index</b>		IP 24	IP 24	IP 24	IP 24	IP 24	IP 24

(\*) The PHR 6, 8, 11 and 15 units are equipped with a single bi-flow regulator used for both heating and cooling operation. The PHR 17 and 20 units are equipped with two regulators (one for heating and one for cooling).

(\*\*) If the water volume of the system is below the minimum, a buffer tank must be installed.

(\*\*\*) If the water volume of the system is above the maximum, an additional expansion tank is required.

# 6 - HEATING PERFORMANCES

PHR 6

HEATING CAPACITY

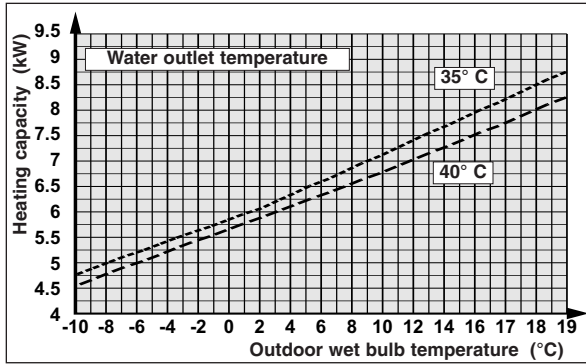

INPUT POWER

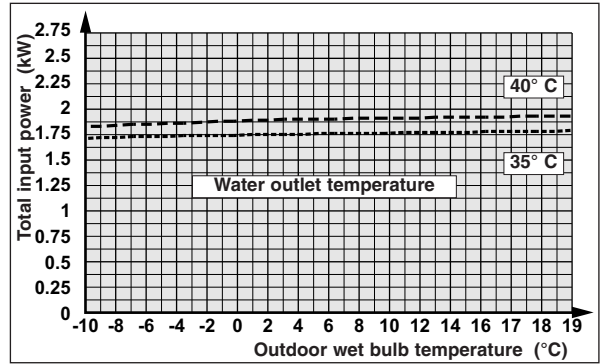

PHR 8

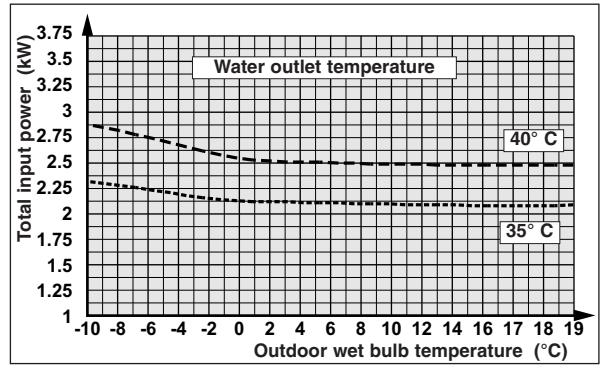
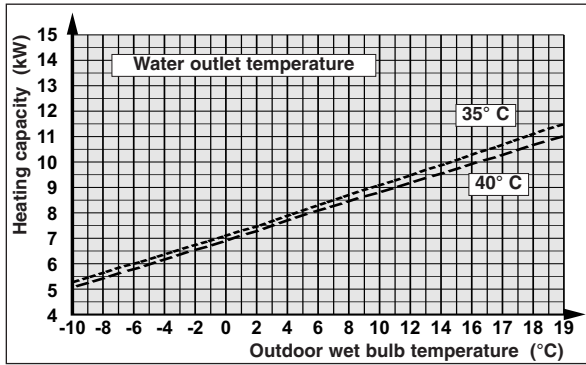

PHR 11

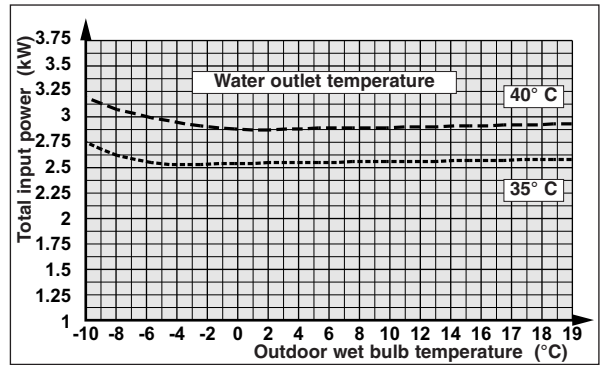
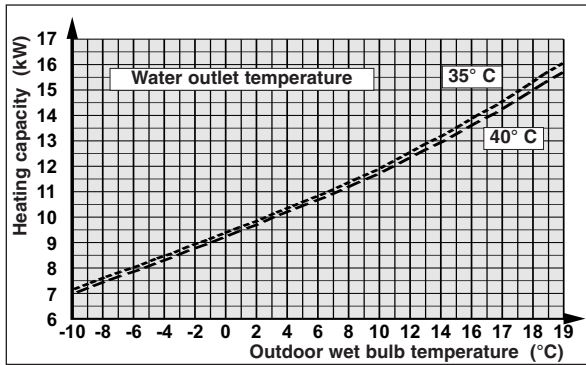

PHR 15

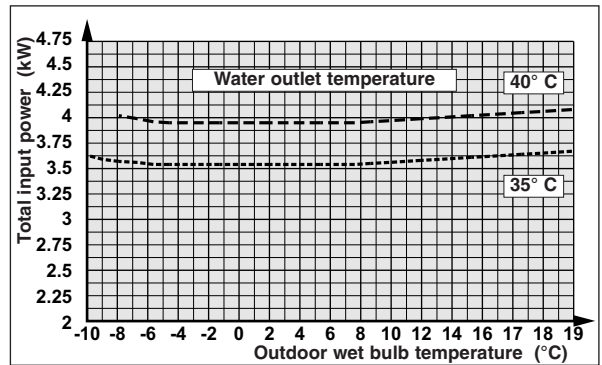
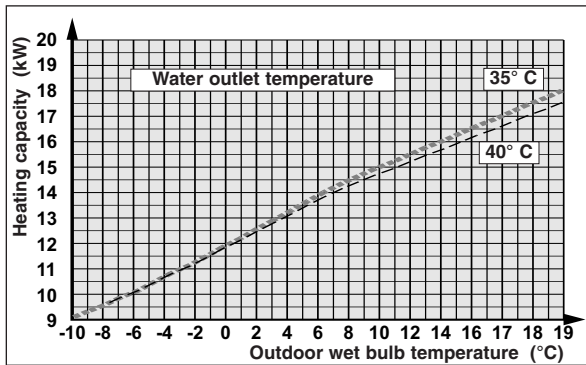

PHR 17

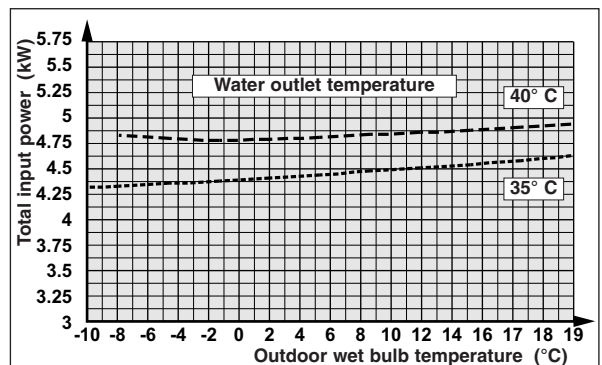
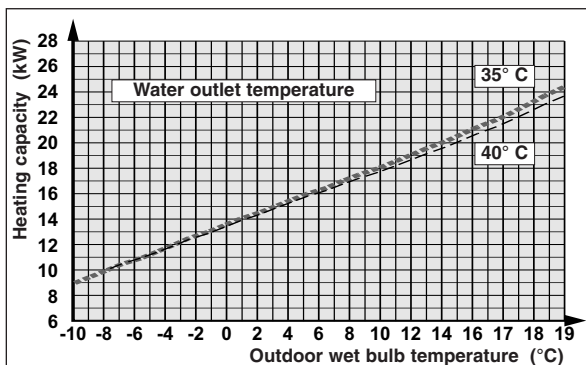

### HEATING CAPACITY

### INPUT POWER

PHR 20

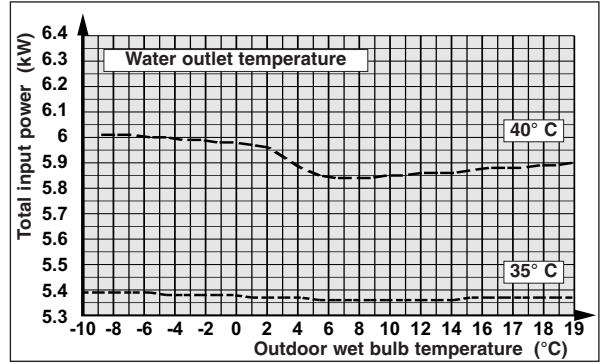
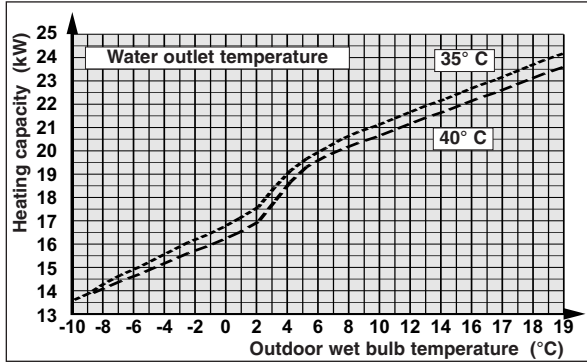

## 7 - COOLING PERFORMANCES

### COOLING CAPACITY

### INPUT POWER

PHR 6

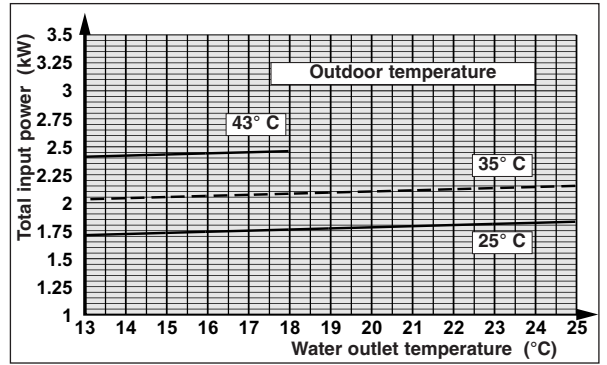
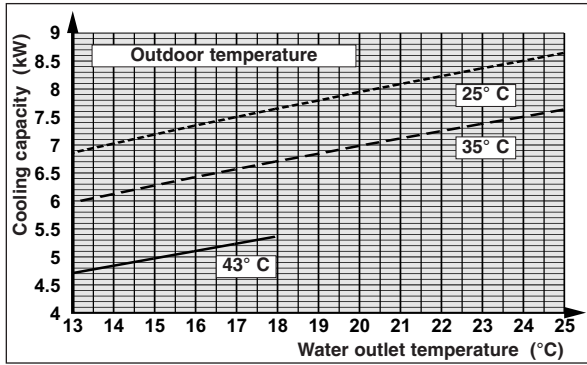

PHR 8

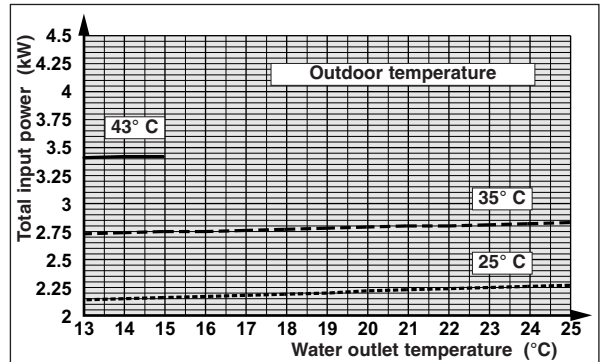
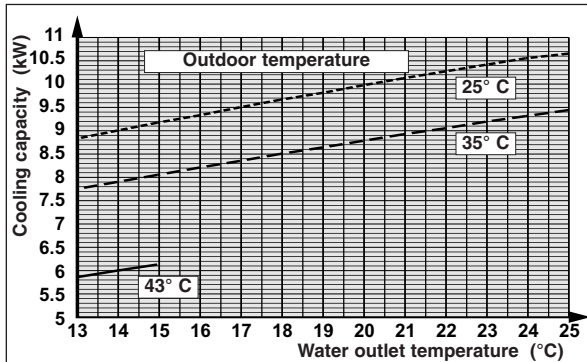

PHR 11

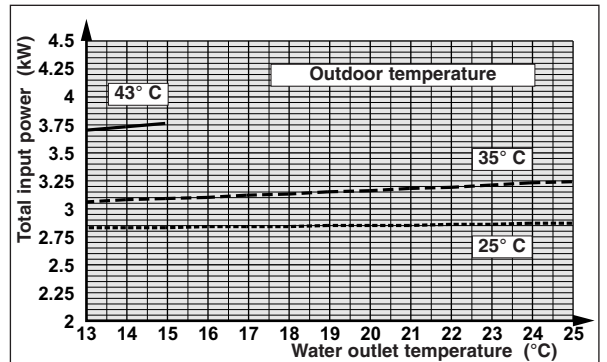
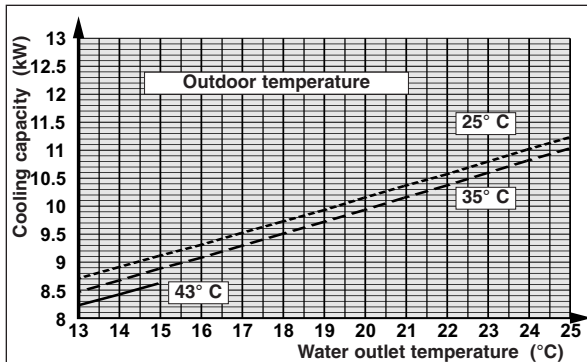

PHR 15

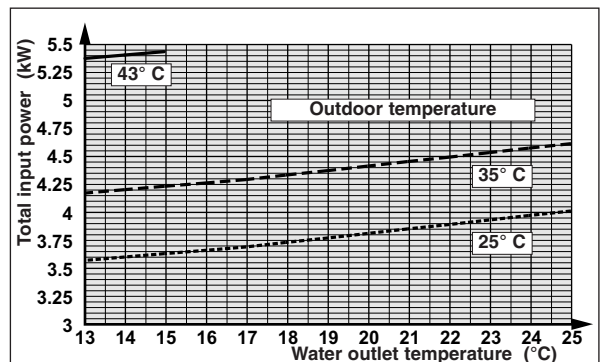
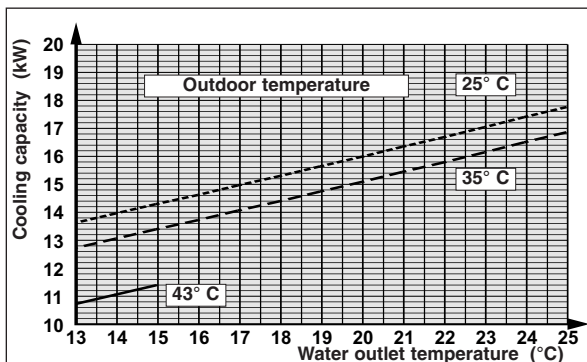

### COOLING CAPACITY

### INPUT POWER

PHR 17

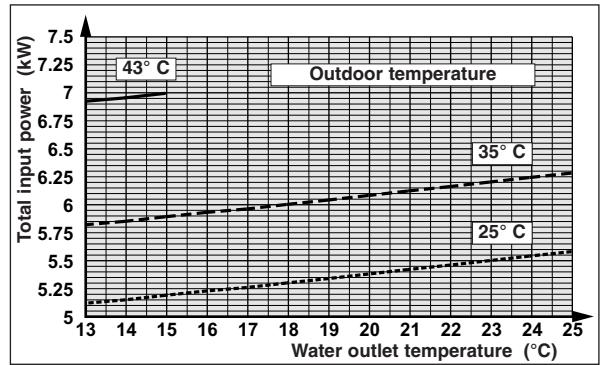
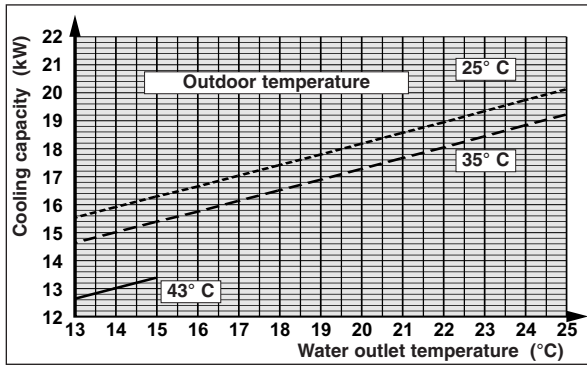

PHR 20

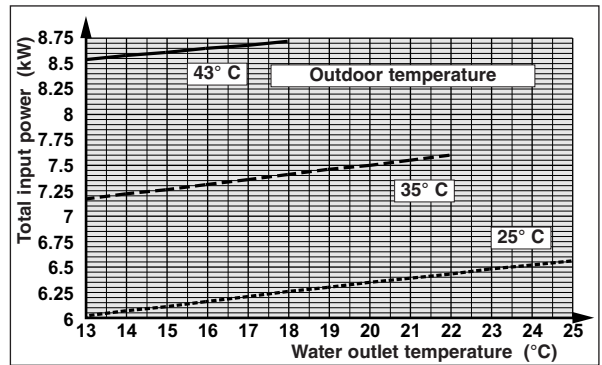
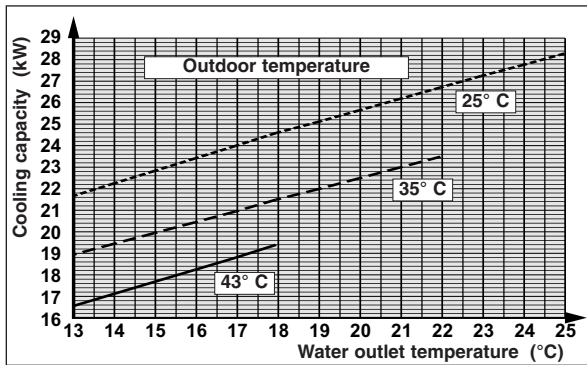

## 8 - CORRECTIONS TO BE MADE WHEN USING ANTI-FREEZE

### (Cooling mode)

#### IMPORTANT:

Use monopropylene glycol.

A minimum rate of 15% to 20% is needed to avoid any risk of corrosion.

### 8.1 - PRINCIPLE OF USING THE CURVES

- Choose the percentage of glycol according to the minimum temperature to protect the hydraulic circuit against frost and determine the coefficients to be applied to the power, the water flow rate and the pressure drop.

### 8.2 - EXAMPLE

- Protection at an external temperature of -15°C, which gives 30% glycol ("Freezing points" curve).
- The "Reduction of cooling capacity" curve gives the coefficient to be applied to the refrigerating capacity (0.94).
- The "Water flow" curve gives the coefficient to be applied to the water flow rate (1.113).
- The "Pressure drop" curve gives the coefficient to be applied to the pressure drop (1.19).

Curves valid for temperature control on the water intake.

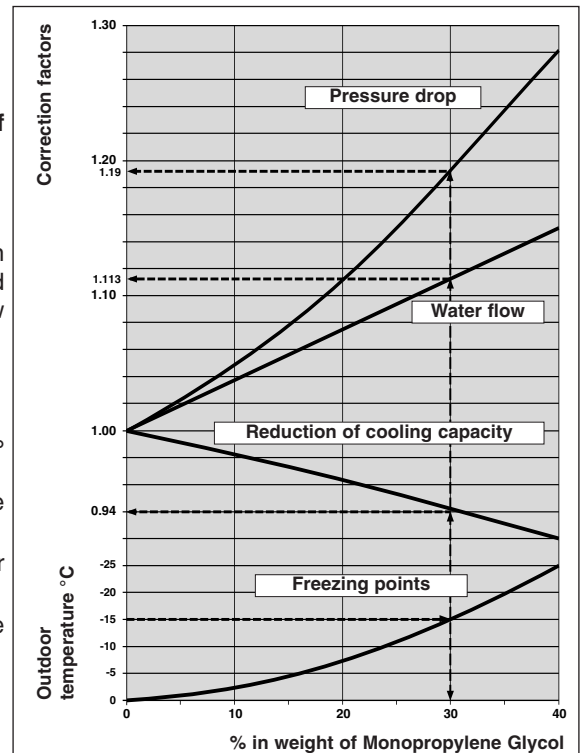

## 9 - CURVES OF AVAILABLE PRESSURES (on unit's outlet)

PHR 6  
PHR 8

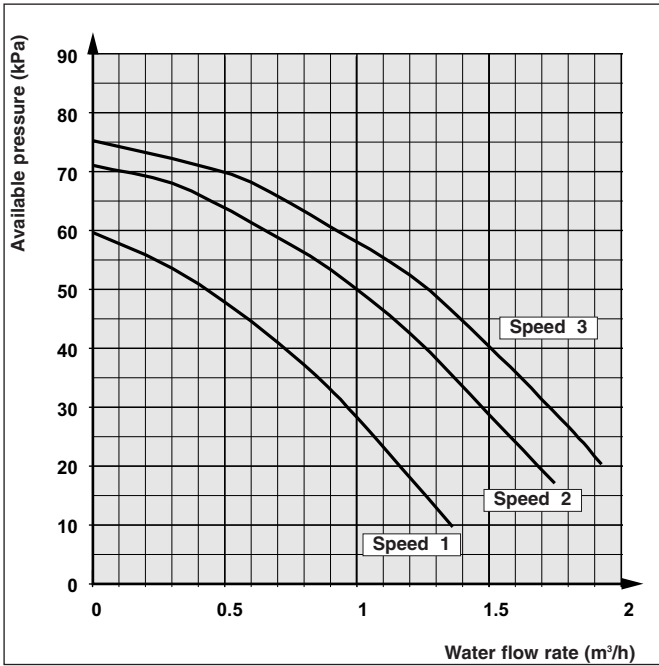

PHR 11

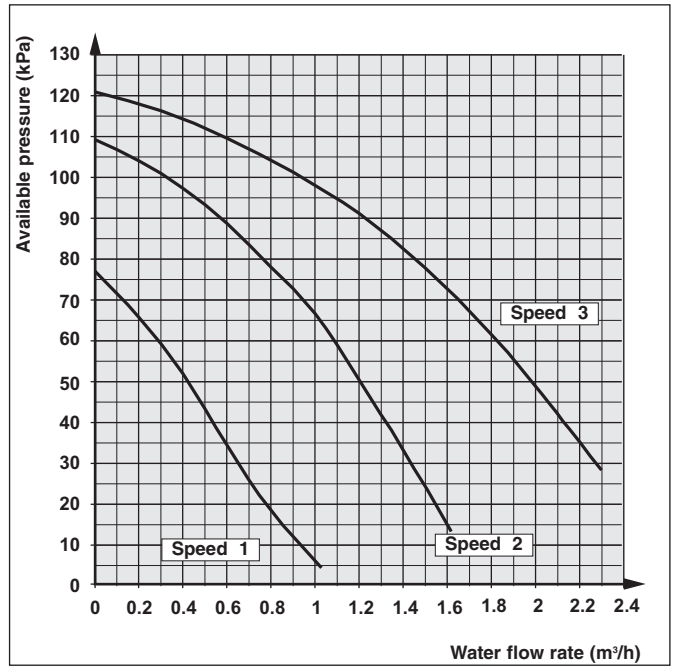

PHR 15

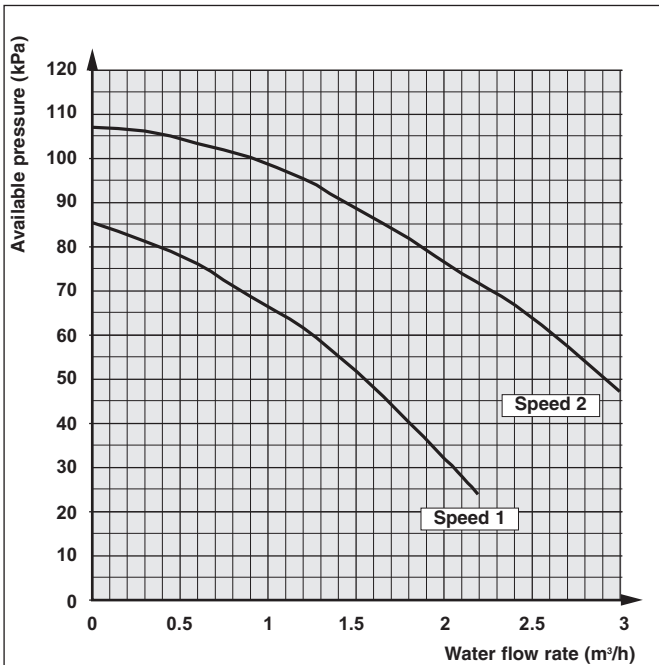

PHR 17

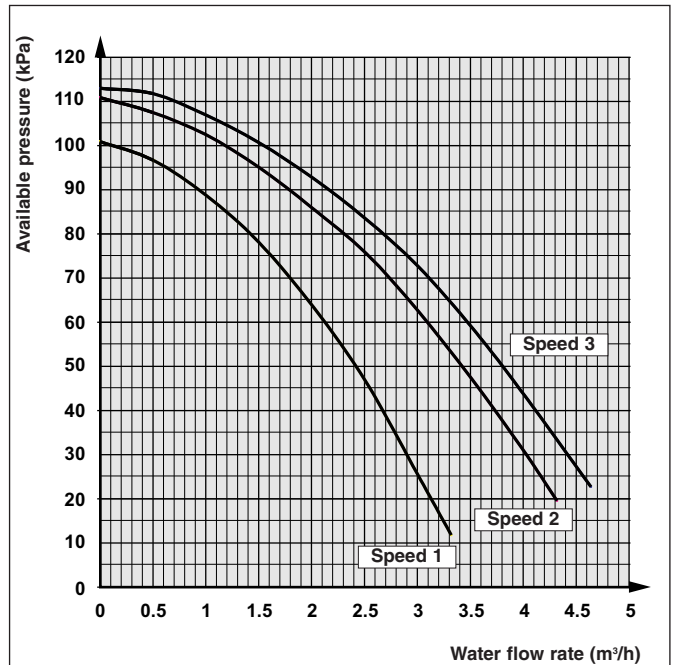

**PHR 20**

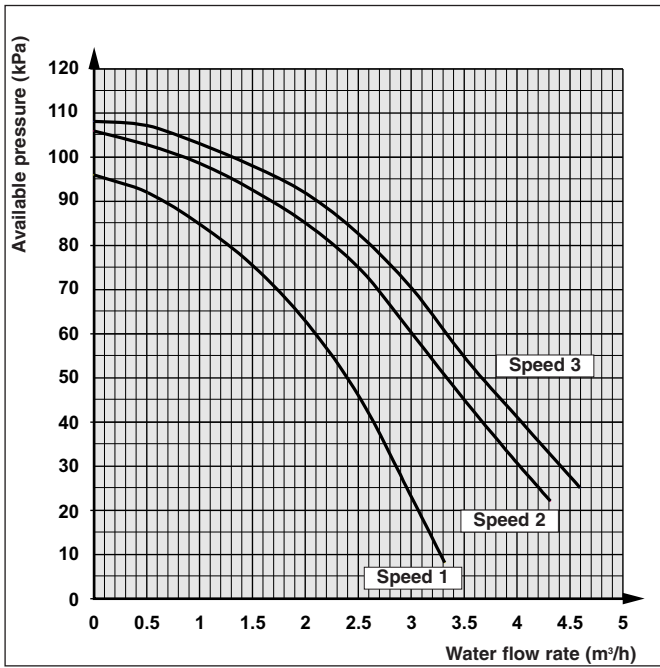

**10 - SOUND LEVELS**

Model	Powerlevel L <sub>w</sub> (dBA)	Sound-pressure level L <sub>p</sub> (dBA)
PHR 6	65	37
PHR 8	65	37
PHR 11	67	39
PHR 15	67	39
PHR 17	67	39
PHR 20	73	45

**Sound-pressure level:**

Unit installed outdoors (free field) on a reflective surface.  
Measurement carried out at a distance of 10 m.



**11 - ACCESSORIES**

	PHR 6	PHR 8	PHR 11	PHR 15	PHR 17	PHR 20
Set of 2 flexible hoses	●	●	—	—	—	—
Condensate tank heating cord kit	●	●	●	●	●	●
Remote control	●	●	●	●	●	●
RS 485 communication interface (MODBUS protocol)	●	●	●	●	●	●

## 12 - "ECH" ELECTRONIC CONTROL

- Microprocessor control module, including:
  - chilled water temperature control (water return),
  - control of operating parameters,
  - self-adapting algorithm for water volume reduction,
  - circulating pump control (frost protection and anti-sticking function),
  - anti-short cycle system,
  - hour counter compressor and circulating pump,
  - alarm management,
  - anti-freeze security (water exchanger),
  - digital display of:
    - . water temperature,
    - . set-point,
    - . alarm code (HP, LP, water output, probes, anti-freeze...).
  - remote alarm reporting is possible via a potential-free contact,
  - integrated condensation pressure control,
  - heating cord control (accessory),
  - remote control with display unit (accessory),
  - serial communications port (RS 485 interface, accessory) - MODBUS Protocol.

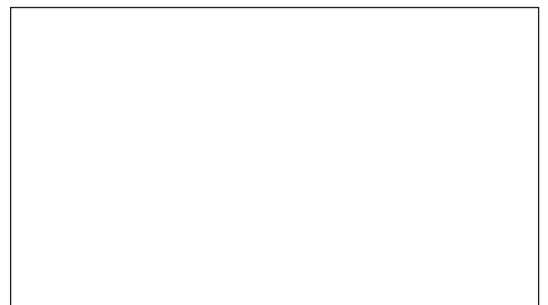

Due to our policy of continuous development, our products are liable to modification without notice.

**Technibel**

R.D. 28 Reyrieux BP 131 01601 Trévoux CEDEX France  
Phone 33 4 74 00 92 92 - Fax 33 4 74 00 42 00  
R.C.S. Bourg-en-Bresse B 759 200 728