



CHG

AIR COOLED WATER CHILLER WITH CONDENSATION BY HELICOIDAL AIR 8 to 17 kW



CHG 8	8.10 kW
CHG 11	11.00 kW
CHG 15	13.70 kW
CHG 17	16.30 kW

MARKING

This product marked  conforms to the essential requirements of the Directives:

- Low voltage no. 2006/95/EC.
- Electromagnetic Compatibility no. 89/336 EEC, modified 92/31 and 93/68 EEC.



SUMMARY

1 - Application - Use	2
2 - Presentation	3
3 - Technical characteristics	4
4 - Physical characteristics	4
5 - Description	5
6 - Cooling performances	6
7 - Corrections to be made when using anti-freeze	7
8 - Curves of available pressures	7
9 - Sound levels	8
10 - Accessories	8
11 - "ECH" electronic control	8

APPLIANCES FILLED WITH R 410 A

R 410 A

- R 410 A is a high-pressure refrigerant (+ 50% in relation to R 22 and R 407 C).
- The compressors approved for operation with this fluid are filled beforehand with polyalcohol oil.
Contrary to mineral oil, it is very hygroscopic: it absorbs the humidity of the ambient air very quickly. This can modify its lubricant properties and lead in time to the destruction of the compressor.

MAINTENANCE INSTRUCTIONS

- 1 - Never add oil to the appliance; the compressor is filled with polyalcohol oil, a special oil which cannot tolerate the presence of other oils.
- 2 - The instruments used for:
 - filling,
 - pressure measurements,
 - emptying under vacuum,
 - recovering the fluid,must be compatible and only used for the R 410 A fluid.
Note: the pressure taps of the refrigerating circuit are 5/16 SAE (1/2 - 20 - UNF)

- 3 - In the case of a new charge:
 - the charge **must** be undertaken in liquid phase,
 - use a balance and a dip pipe type R 410 A cylinder,
 - charge the weight of R 410 A as per the value indicated on the unit's identification plate (for "split systems", refer to the installation instructions as the charge must consider the length of the connecting lines).
- 4 - In case of leakage, do not complete the charge: recover the remaining refrigerant for recycling and perform a total charge.
Recovery, recycling or the destruction of the fluid must be done in compliance with the laws in force in the country concerned.
- 5 - If the refrigerant circuit is opened, you must:
 - avoid the entry of air into the circuit as much as possible,
 - replace or install a drier,
 - perform the "vacuum operation" at a minimum level of **0.3 mbar (static)**.

1 - APPLICATION - USE

- This appliance generates chilled water for the air-conditioning of premises, using terminal units.

2 - PRESENTATION

2.1 - DESCRIPTION

- 1 - Sound-proofed hermetic compressor.
- 2 - Plate water heat exchanger.
- 3 - "Plate-Fin" air heat exchanger.
- 4 - Fan motor.
- 5 - Fan protection grille.
- 6 - Electrical box.
- 7 - Microprocessor control unit display keyboard.
- 8 - Circulating pump.

- 9 - Expansion tank.
- 10 - Safety valve.
- 11 - Pressure gauge.
- 12 - Water inlet connector.
- 13 - Water outlet connector.
- 14 - Filling / drainage of the water circuit.
- 15 - Air vent.
- 16 - Hole for connecting cables.

Materials:

- Copper piping.
- Painted sheet metal cabinet.
- Copper/aluminium air heat exchanger.
- Stainless steel water heat exchanger.
- Plastic grille.

CHG 8

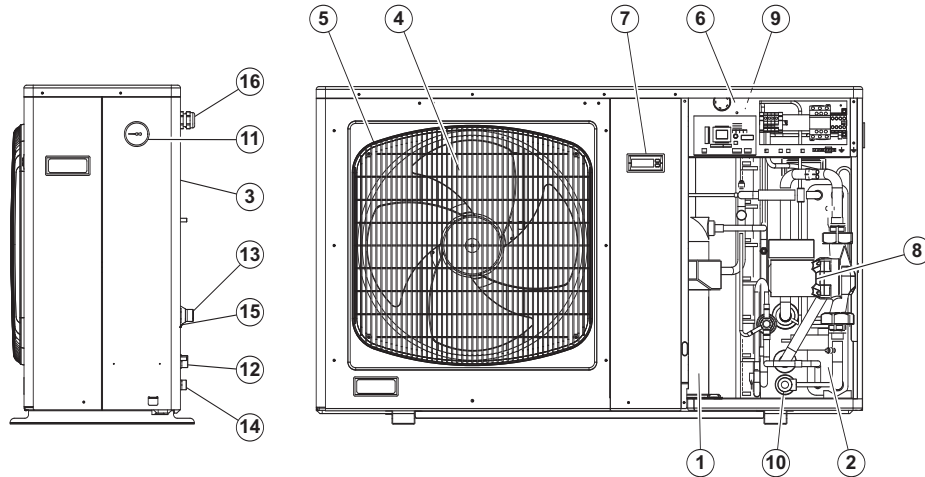

CHG 11
CHG 15
CHG 17

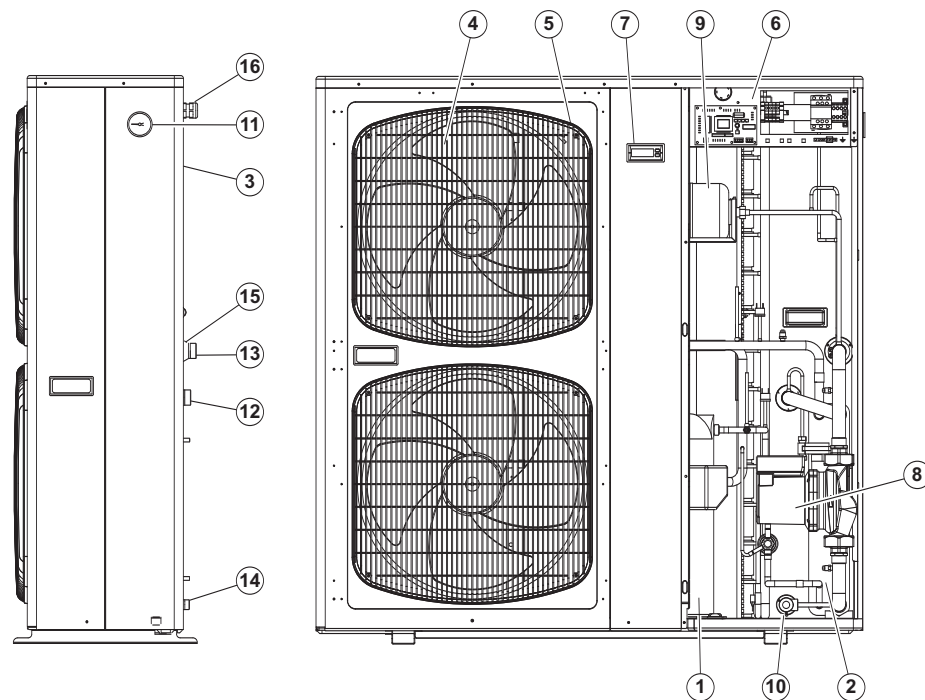

NOTE: The units are supplied with a water filter which is to be installed on the water intake.

2.2 - ELECTRICAL EQUIPMENT

- Per EN 60 335-2-40.
- "ECH" electronic control with fan speed control
- Pressure safety cutout.
- Water flow detector.

3 - TECHNICAL CHARACTERISTICS

Model		CHG 8	CHG 11	CHG 15	GHG 17	
Cooling capacity	kW	8.10	11.00	13.70	16.30	
Nominal power consumption*	kW	3.63 / 3.56	4.42	5.26	6.23	
EER*		2.23 / 2.28	2.49	2.60	2.62	
Total Max. power consumption	1-phase	kW	4.80	—	—	
	3-phase	kW	4.30	6.10	7.10	8.70
Total Max. current consumption	1-phase	A	23	—	—	
	3-phase	A	9	12	14	17
Nominal water flow		m ³ /h	1.40	1.91	2.34	2.81
		10 ⁻⁴ m ³ /s	3.90	5.30	6.50	7.80
Available pressure	kPa	42	55	68	75	

(*) Gross value (without circulator)

Single-phase / Three-phase

NOMINAL OPERATING CONDITIONS

- Outside air temperature (dry): + 35°C
- Water outlet temperature: + 7°C

NOTE: Water system pressure: 1.5 to 3 bar.

OPERATING LIMITS (pure water) (*)

- Max. outside air temperature (dry): + 43°C
- Min. outside air temperature (dry): - 10°C (CHG 8 and CHG 15); - 7°C (CHG 11); - 4°C (CHG 17)
- Max. water outlet temperature for 43°C external: + 15°C
- Max. water outlet temperature for 35°C external: + 18°C
- Min. water outlet temperature: + 5°C

(*) The limits indicated are those of the machine.

4 - PHYSICAL CHARACTERISTICS

Model		CHG 8	CHG 11	CHG 15	CHG 17	
Dimensions	L	mm	1,190	1,190	1,190	1,190
	H	mm	735	1,235	1,235	1,235
	P	mm	340	340	340	340
	Weight	kg	87	120	123	130
Dimensions packaged	L	mm	1,270	1,270	1,270	1,270
	H	mm	920	1,420	1,420	1,420
	P	mm	420	420	420	420
	Weight	kg	99	133	136	143

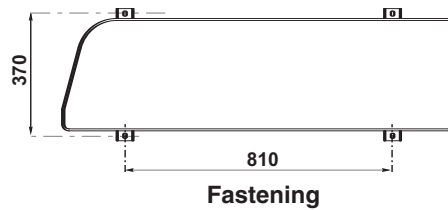
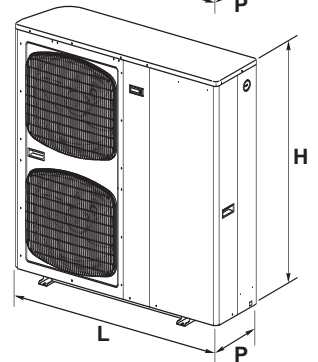
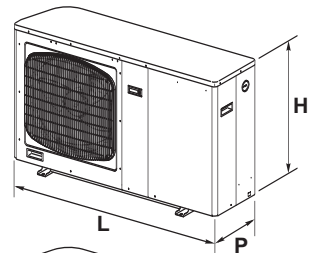

1	Water inlet connection (male)
2	Water outlet connection (male) with air vent valve
3	Water circuit fill/drain
4	Holes for electric cables

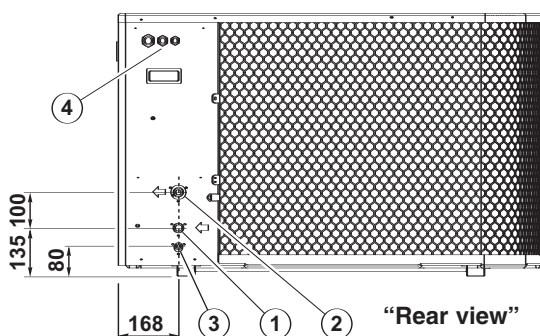

CHG 8

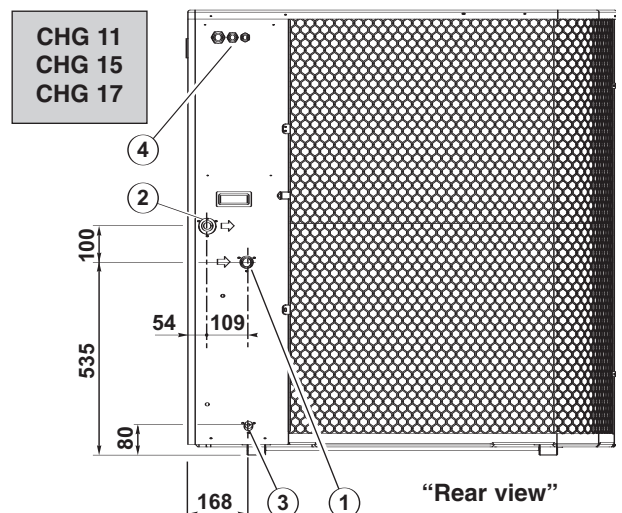

5 - DESCRIPTION

Model		CHG 8	CHG 11	CHG 15	CHG 17
Hermetic "SCROLL" compressor with thermal protection		●	●	●	●
Sound insulation cover		●	●	●	●
Power supply	230V/1/50Hz	●	—	—	—
	400V/3N/50Hz	●	●	●	●
Start-up current	1-phase A	97	—	—	—
	3-phase A	48	64	74	101
Start-up current with kit single-phase start-up (accessory)	A	44	—	—	—
Direct drive propeller fan motor with thermal protection, horizontal blowing		1	2	2	2
Total air flow	m³/h	3,000	6,000	6,000	6,000
	m³/s	0.833	1.667	1.667	1.667
Propellor diameter	mm	460	460	460	460
Power supply	230V/1/50Hz	●	●	●	●
Rotation speed	rpm	770	770	770	770
Current	A	0.7	1.4	1.4	1.4
Power input	kW	0.140	0.280	0.280	0.280
Air exchanger with louver fins		●	●	●	●
Water exchanger Plate-type stainless steel water treatment section		●	●	●	●
Water capacity	litres	0.7	0.84	1.05	1.40
Expansion system	expansion valve	●	●	●	●
Charged internal cooling system with HP and LP switch		1	1	1	1
R 410 A refrigerant Total charge	kg	1.8	3.6	3.3	2.8
Circulating pump		●	●	●	●
Current	A	0.8	1	1.3	1.6
Power input	kW	0.16	0.24	0.28	0.32
Power supply	230V/1/50Hz	●	●	●	●
Expansion tank (charge pressure 1.5 bar)		●	●	●	●
Capacity	litres	2	2	2	2
Safety valve (pressure 3 bar)		●	●	●	●
Pressure gauge (0 to 6 bar)		●	●	●	●
Air vent valve		●	●	●	●
Hydraulic system					
Male connections	inlet	3/4"	1"	1"	1"
	outlet	3/4"	1"	1"	1"
Water capacity of the unit	litres	2.2	2.6	2.8	3.2
Water flow rate detection pressure differential cut-out		●	●	●	●
Water filter supplied, uninstalled		●	●	●	●
Water volume in system					
Minimum water volume (*)	litres	30	40	50	60
Maximum water volume (**)	litres	400	400	400	400
Mains power supply					
Power supply	230V/1/50Hz	●	—	—	—
	400V/3N/50Hz	●	●	●	●
Equipment protection index		IP 24	IP 24	IP 24	IP 24

(*) If the water volume of the system is below the minimum, a buffer tank must be installed.

(**) If the water volume of the system is above the maximum, an additional expansion tank is required.

6 - COOLING PERFORMANCES

COOLING CAPACITY

INPUT POWER

CHG 8

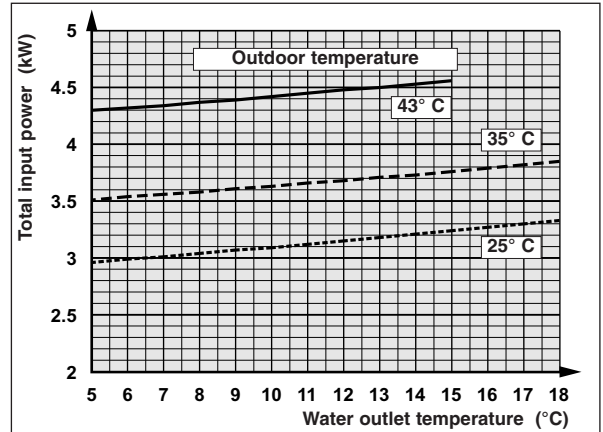
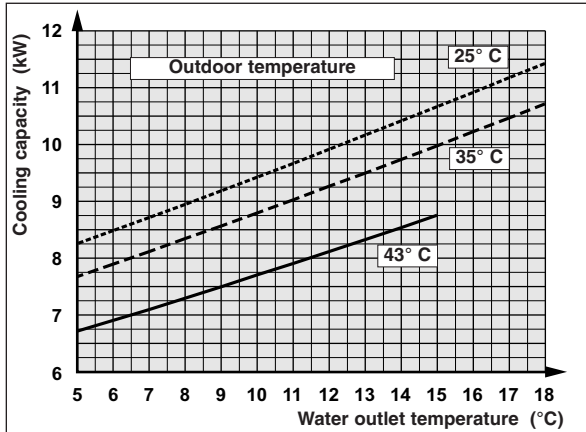

CHG 11

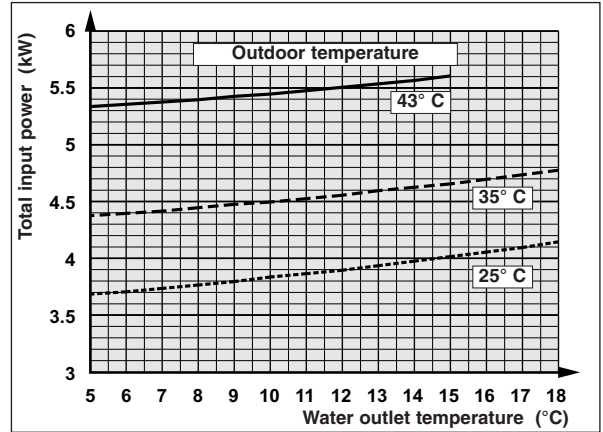
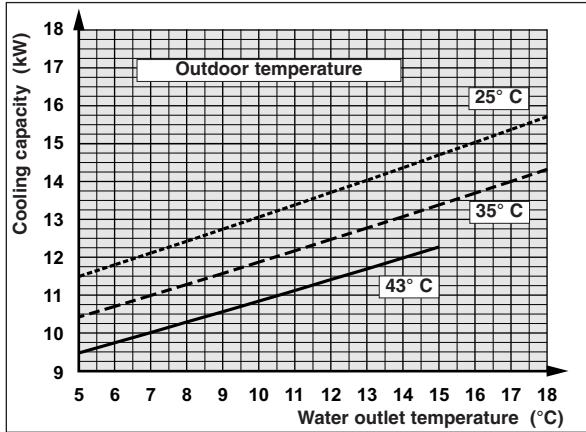

CHG 15

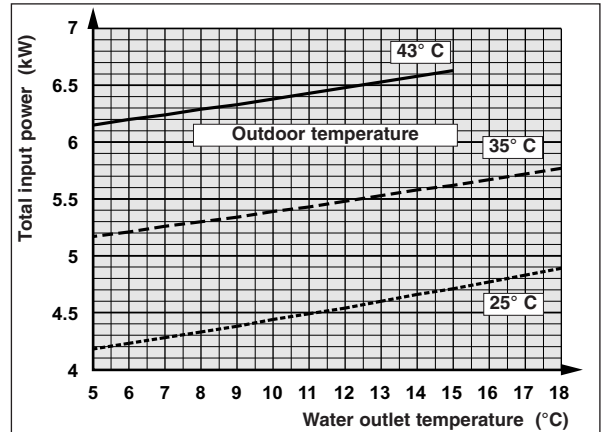
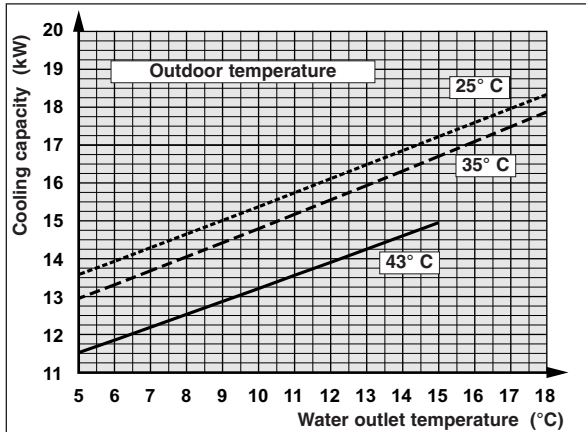

CHG 17

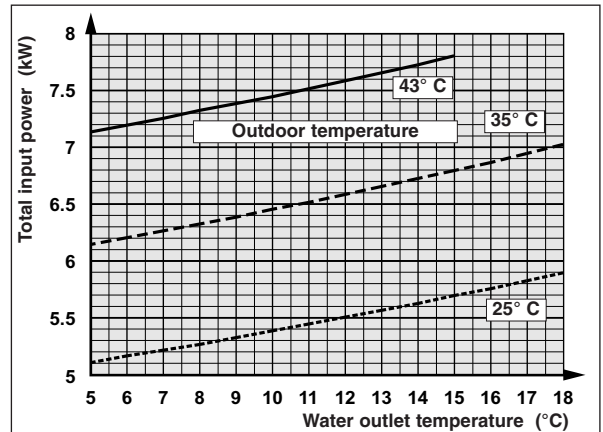
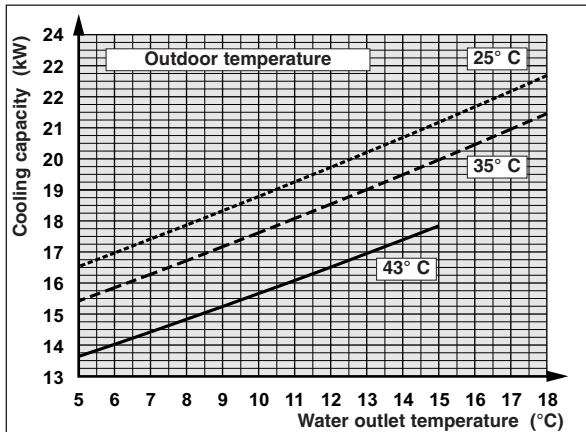

7 - CORRECTIONS TO BE MADE WHEN USING ANTI-FREEZE

(Cooling mode)

IMPORTANT :

Use monopropylene glycol.

A minimum rate of 15% to 20% is needed to avoid any risk of corrosion.

7.1 - PRINCIPLE OF USING THE CURVES

- Choose the percentage of monopropylene glycol according to the minimum temperature to protect the hydraulic circuit against frost and determine the coefficients to be applied to the power, the water flow rate and the pressure drop.

7.2 - EXAMPLE

- Protection at an external temperature of -15°C , which gives 30% glycol ("Freezing points" curve).
- The "Reduction of cooling capacity" curve gives the coefficient to be applied to the refrigerating capacity (0.94).
- The "Water flow" curve gives the coefficient to be applied to the water flow rate (1.113).
- The "Pressure drop" curve gives the coefficient to be applied to the pressure drop (1.19).

Curves valid for temperature control on the water intake.

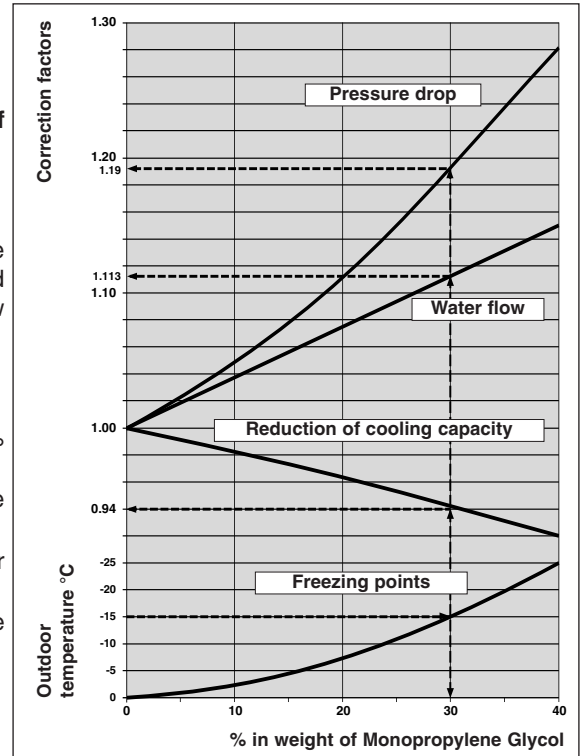

8 - CURVES OF AVAILABLE PRESSURES (on unit's outlet)

CHG 8

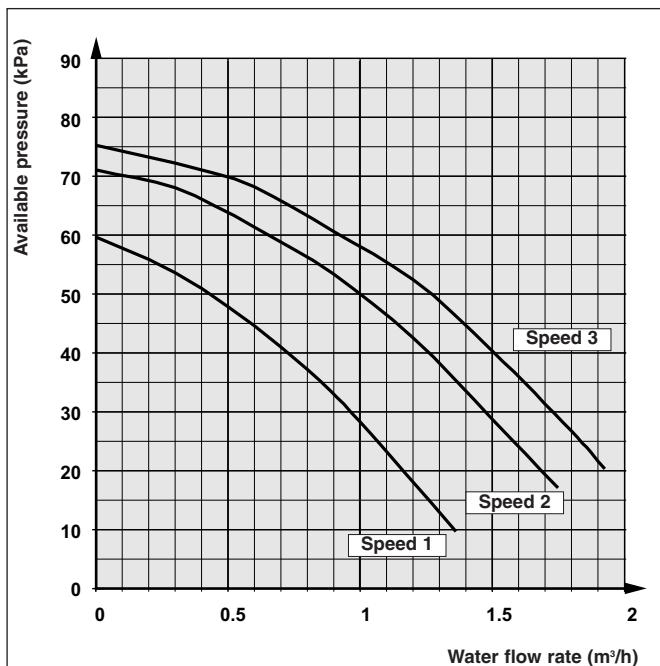

CHG 11

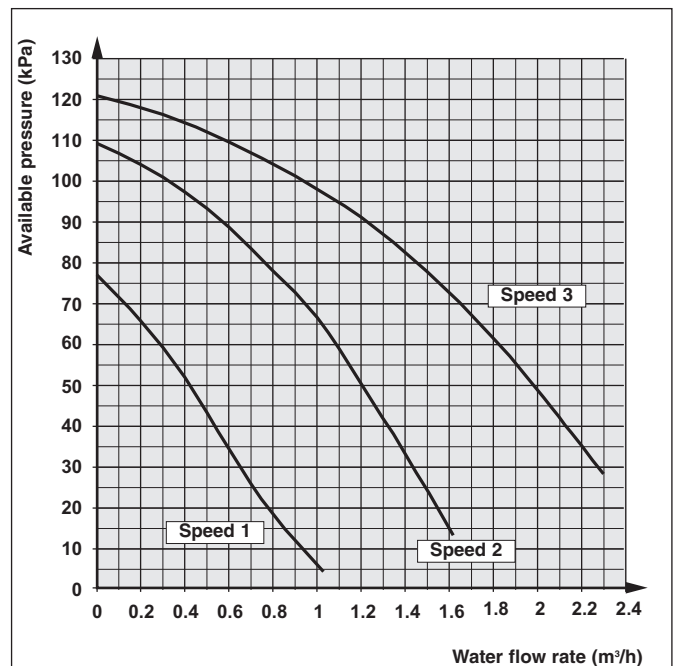

CHG 15

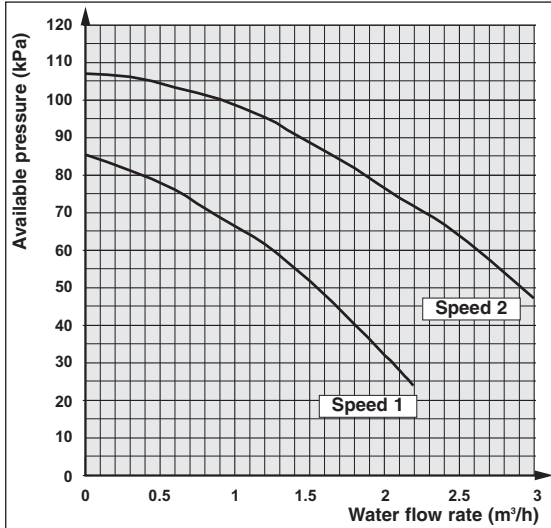

CHG 17

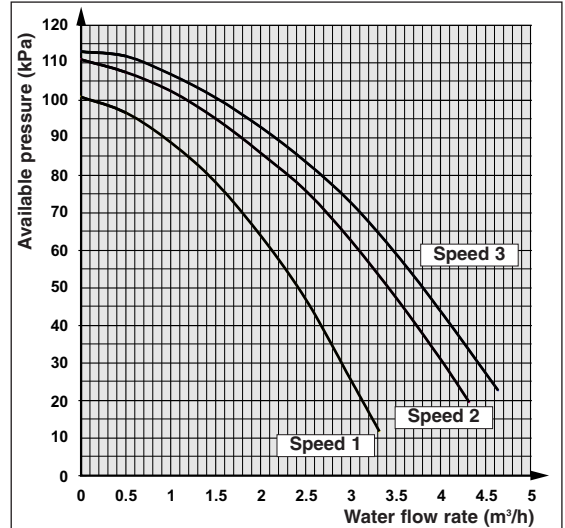

9 - SOUND LEVELS

Model	Powerlevel L _w (dBA)	Sound-pressure level L _p (dBA)
CHG 8	65	37
CHG 11	67	39
CHG 15	67	39
CHG 17	67	39

Sound-pressure level:

Unit installed outdoors (free field) on a reflective surface.
Measurement carried out at a distance of 10 m.



10 - ACCESSORIES

	CHG 8	CHG 11	CHG 15	CHG 17
Set of 2 flexible hoses	length 1 m Ø 3/4"	●	—	—
	length 1 m Ø 1"	—	●	●
Insulated tank 35 liters	●	●	●	●
Single start-up kit (for single-phase model)	●	—	—	—
Remote control	●	●	●	●
RS 485 communication interface (MODBUS protocol)	●	●	●	●

11 - "ECH" ELECTRONIC CONTROL

- Microprocessor control module, including:
 - chilled water temperature control (water return),
 - control of operating parameters,
 - self-adapting algorithm for water volume reduction,
 - circulating pump control (frost protection and anti-sticking function),
 - dynamic setpoints are possible according to the outside temperature (to be activated at the time of installation by means of special parameterization),
 - anti-short cycle system,
 - hour counter compressor and circulating pump,
 - alarm management,
 - anti-freeze security (water exchanger),
 - digital display of :
 - . water temperature,
 - . set-point,
 - . alarm code (HP, LP, water output, probes, anti-freeze...).
 - remote alarm reporting is possible via a potential-free contact,
 - integrated condensation pressure control,
 - remote control with display unit (accessory),
 - serial communications port (RS 485 interface, accessory).

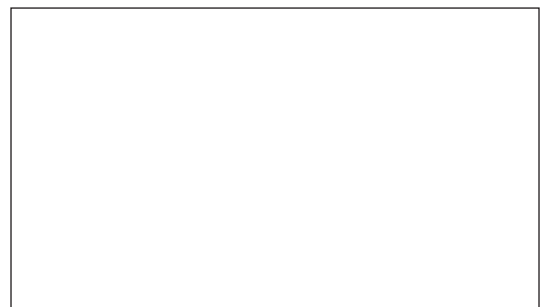

Due to our policy of continuous development, our products are liable to modification without notice.

Technibel

R.D. 28 Reyrieux BP 131 01601 Trévoux CEDEX France
Phone 33 4 74 00 92 92 - Fax 33 4 74 00 42 00
R.C.S. Bourg-en-Bresse B 759 200 728