

# H.I.D. lamps

# LP Sodium SOX(-E)

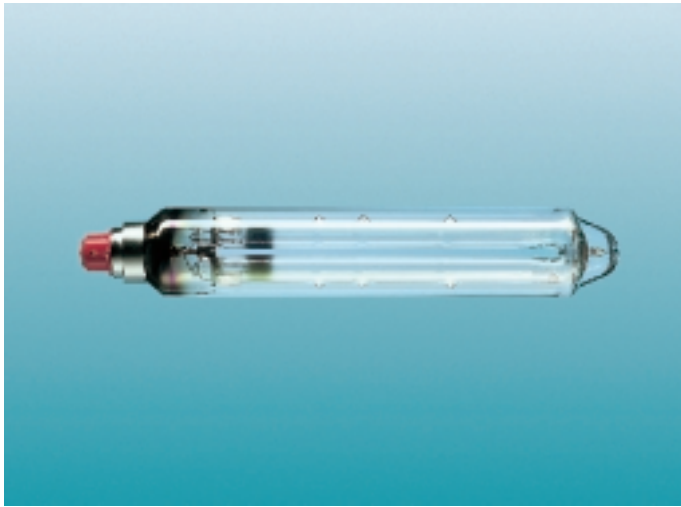

SOX



SOX-E

SOX(-E) low-pressure sodium vapour lamps have a U-shaped discharge tube, containing sodium, enclosed in an evacuated clear tubular outer bulb.

With their extremely high luminous efficacy they are the most efficient light sources for road lighting, security and tunnel lighting.

### SOX-E

Compared with SOX lamps, the SOX-E lamps have reduced heat losses and hence an even higher lamp efficacy.

### Unique dimples

The U-shaped discharge tube of SOX(-E) low-pressure sodium lamps is made of a special sodium-resistant glass with dimples to collect the sodium in the cooling stage. Thus, a uniform distribution of sodium along the discharge tube is achieved, which means a more stable discharge, a higher efficacy and a better lumen maintenance and lamp life.

A neon-argon mixture is added to facilitate starting.

The colour is monochromatic yellow, with colour rendering non-existent.

SOX(-E) lamps employ a ballast and an ignitor or a leak-transformer.

### SOX(-E) and HF electronic gear

An even further improvement of the efficacy of SOX(-E) lamps can now be reached by operating these lamps on HF electronic gear: a nearly equal amount of light for 10 to 40% less energy. Next to that HF gear provides a zero influence from mains voltage variations on lamp parameters.

### Burning positions

The burning position of the SOX 35 and 55 W and the SOX-E 18, 26 and 36 W types is vertical, base up with a tolerance of +/-110 degrees (when luminaires are installed in shock-free positions: universal burning position).

The SOX 90, 135 and 180 W and the SOX-E 66, 91 and 131 W have a horizontal burning position with a tolerance of +/-20 degs.

### Applications

- Road lighting, marshalling yards, railway crossings, airports, harbours and docks, quarries, foundries and rolling mills.
- Security and orientation lighting.

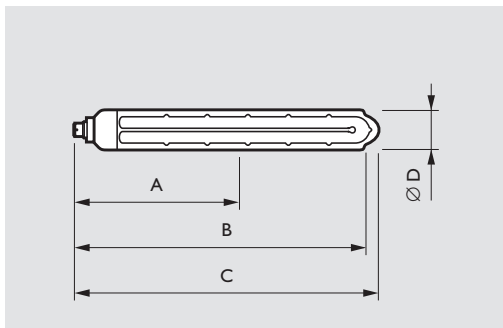

Dimensions in mm

Type	A max.	B max.	C max.	D max.
SOX 35W	183	279	311	52
SOX 55W	240	393	425	52
SOX 90W	291	485	528	68
SOX 135W	412	732	775	68
SOX 180W	580	1089	1120	68
SOX-E 18	140	84	216	52
SOX-E 26	183	279	311	52
SOX-E 36	240	393	425	52
SOX-E 66	291	485	528	68
SOX-E 91	412	732	775	68
SOX-E 131	580	1089	1120	68

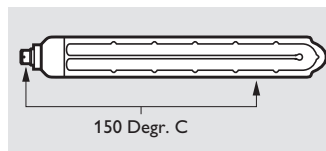

Max. permissible temperatures

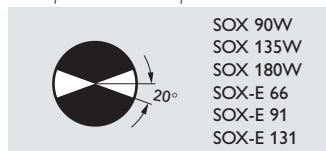

Burning positions

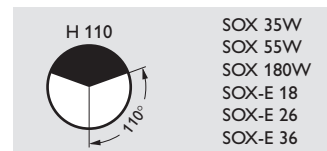

Type	Lamp wattage W	Lamp voltage V	Lumen output lm	Efficacy source lm/W	Average system power W <sup>1)</sup>	Average system efficacy lm/W <sup>1)</sup>	Nett weight g	Ordering number	EOC
<b>SOX on Philips hybride gear</b>									
SOX 35W BY22D	37	70	4550	123	46	100	222	9281 455 00000	179739
SOX 55W BY22D	56	109	7800	140	77	102	308	9281 460 00000	179753
SOX 90W BY22D	89	112	13000	146	101	129	493	9281 465 00000	179777
SOX 135W BY22D	129	164	20800	161	155	134	717	9281 470 00000	179791
SOX 180W BY22D	180	240	32500	179	211	154	1044	9281 475 00000	179814
<b>SOX on Philips autoleak ballast</b>									
SOX 35W BY22D	37	70	4550	130	57	84	222	9281 455 00000	179739
SOX 55W BY22D	55	109	7800	147	76	105	308	9281 460 00000	179753
SOX 90W BY22D	91	112	14000	154	119	113	493	9281 465 00000	179777
SOX 135W BY22D	135	164	22600	167	165	136	717	9281 470 00000	179791
SOX 180W BY22D	181	240	32000	176	216	153	1044	9281 475 00000	179814
<b>SOX-E on Philips optimal hybride gear</b>									
SOX-E 18 BY22D	18	55	1770	99	26	69	150	9281 452 00000	192806
SOX-E 26 BY22D	27	81	3700	137	33	112	222	9281 457 00000	179746
SOX-E 36 BY22D	38	120	6160	160	48	122	308	9281 458 00000	179760
SOX-E 66 BY22D	65	110	10700	165	81	133	493	9281 459 00000	179784
SOX-E 91 BY22D	90	165	17000	189	108	158	717	9281 461 00000	179807
SOX-E 131 BY22D	128	235	26000	203	150	173	1044	9281 451 00000	179821
<b>SOX-E on Philips hybrid gear for SOX</b>									
SOX-E 26 BY22D	28	81	3500	125	40	88	222	9281 457 00000	179746
SOX-E 36 BY22D	37	120	5800	157	57	102	308	9281 458 00000	179760
SOX-E 66 BY22D	71	110	10500	148	92	114	493	9281 459 00000	179784
SOX-E 91 BY22D	96	165	16000	167	127	126	717	9281 461 00000	179807
SOX-E 131 BY22D	131	235	26000	198	167	156	1044	9281 451 00000	179821
<b>SOX-E on Philips autoleak ballast for SOX</b>									
SOX-E 26 BY22D	27	81	3600	133	49	73	222	9281 457 00000	179746
SOX-E 36 BY22D	39	120	6000	154	59	102	308	9281 458 00000	179760
SOX-E 66 BY22D	67	110	10500	157	104	106	493	9281 459 00000	179784
SOX-E 91 BY22D	101	165	18200	180	139	131	717	9281 461 00000	179807
SOX-E 131 BY22D	140	235	27000	193	179	151	1044	9281 451 00000	179821
<b>SOX on Philips HF Electronic gear</b>									
SOX 35W BY22D	33	-	4300	129	-	-	-	9281 455 00000	179739
SOX 55W BY22D	51	-	7500	147	57	137	308	9281 460 00000	179753
<b>SOX-E on Philips HF Electronic gear</b>									
SOX-E 36 BY22D	35	-	5800	166	38	153	308	9281 458 00000	179760
SOX-E 66 BY22D	63	-	10700	170	68	157	493	9281 459 00000	179784

<sup>1)</sup> After 100 burning hours.

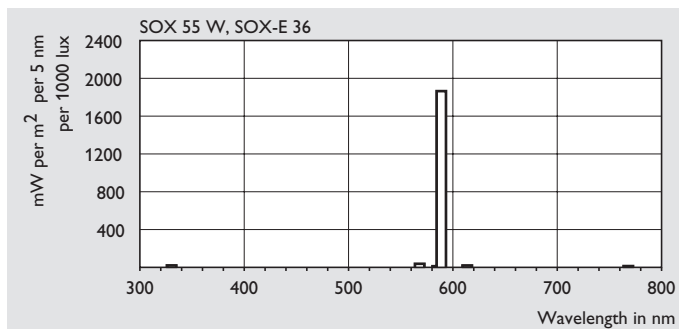

Spectral power distribution

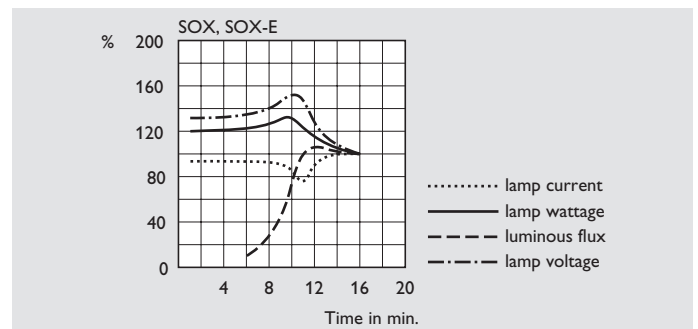

Lamp performance during run-up

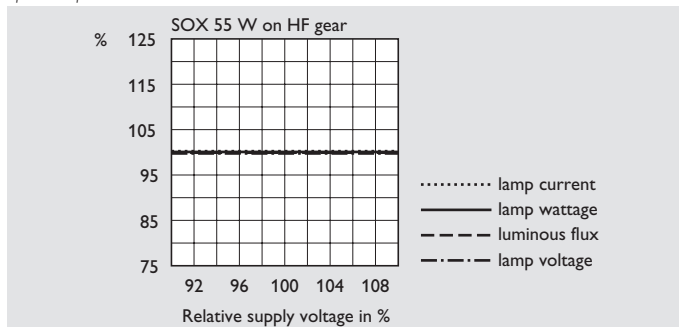

Effects of mains voltage variations

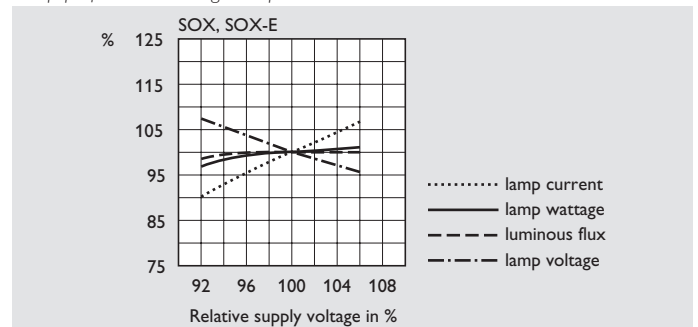

Effects of mains voltage variations

