

# Compact fluorescent lamps non-integrated

## MASTER PL-C 4-pin

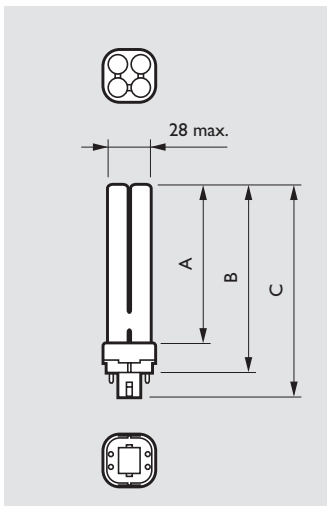

Dimensions in mm

Type	A max.	B max.	C max.
PL-C 10W/4P	77	95	110
PL-C 13W/4P	99	117	132
PL-C 18W/4P	111	129	144
PL-C 26W/4P	132	150	165

The MASTER PL-C 4-pin range of lamps forms part of the compact fluorescent non-integrated family of lamps. Compact long-arc low-pressure mercury discharge lamp with a clear glass envelope consisting of four parallel narrow fluorescent tubes welded together at the bottom and near the ends. It has a four-pin base without the starter and capacitor. It is equipped with two pre-heated tungsten electrodes and filled with a mixture of saturated mercury vapour and an inert buffer gas.

Well adapted to be used in combination with electronic gear, offering the possibility of controllable light output, HF operation and independence from the supply system. It is for instance, possible to use AC and DC supply and a wide range of supply voltages.

Dimming is possible. The lamp characteristics are influenced by operating conditions and control gear used. The lamp performance is strongly governed by the temperature of the coolest spot, which is influenced by the lamp position.

MASTER PL-C is a breakthrough in compact fluorescent lighting. By making use of the unique Philips-invented bridge technology, light output has been optimised for the relatively high temperatures inside the luminaire, providing up to 6% higher system light output. Furthermore the advanced coating technologies result in 12% lumen maintenance improvement at average rated life. MASTER PL-C lamps contain only 3 mg of mercury.

### Applications

- General or supplementary lighting in professional environments or the home.
- Recessed or surface-mounted downlighters, wall units, pendant lamps and table lamps.

Type	Cap/ base	Lamp voltage	Lamp current	Lumen output	Efficacy	Corr. colour temp.	Chromaticity coordinates		Colour designation	Lumen maint. 2000hrs	Lumen maint. 5000hrs	Nett weight	Ordering number	EOC
		V	mA	lm	lm/W	K	x	y		%	%	g		
<b>/827</b>														
MASTER PL-C 10W/827/4P	G24q-1	51	190	600	63	2700	455	415	INCAND.LIGHT	92	87	53	9279 037 08200	623256
MASTER PL-C 13W/827/4P	G24q-1	77	165	900	72	2700	455	415	INCAND.LIGHT	92	87	63	9279 052 08200	623263
MASTER PL-C 18W/827/4P	G24q-2	80	210	1200	73	2700	455	415	INCAND.LIGHT	92	87	68	9279 056 08200	623270
MASTER PL-C 26W/827/4P	G24q-3	80	300	1800	75	2700	455	415	INCAND.LIGHT	92	87	79	9279 060 08200	623287
<b>/830</b>														
MASTER PL-C 10W/830/4P	G24q-1	51	190	600	63	3000	435	400	WARM WHITE	92	87	53	9279 037 08300	623294
MASTER PL-C 13W/830/4P	G24q-1	77	165	900	72	3000	435	400	WARM WHITE	92	87	63	9279 052 08300	623317
MASTER PL-C 18W/830/4P	G24q-2	80	210	1200	73	3000	435	400	WARM WHITE	92	87	68	9279 056 08300	623331
MASTER PL-C 26W/830/4P	G24q-3	80	300	1800	75	3000	435	400	WARM WHITE	92	87	79	9279 060 08300	623355
<b>/835</b>														
MASTER PL-C 26W/835/4P	G24q-3	80	300	1800	75	3500	400	410	WHITE	92	87	79	9279 060 83500	866530
<b>/840</b>														
MASTER PL-C 10W/840/4P	G24q-1	51	190	600	63	4000	380	380	COOL WHITE	92	87	53	9279 037 08400	623300
MASTER PL-C 13W/840/4P	G24q-1	77	165	900	72	4000	380	380	COOL WHITE	92	87	63	9279 052 08400	623324
MASTER PL-C 18W/840/4P	G24q-2	80	210	1200	73	4000	380	380	COOL WHITE	92	87	68	9279 056 08400	623348
MASTER PL-C 26W/840/4P	G24q-3	80	300	1800	75	4000	380	380	COOL WHITE	92	87	79	9279 060 08400	623362



# Compact fluorescent lamps non-integrated

MASTER PL-C 4-pin

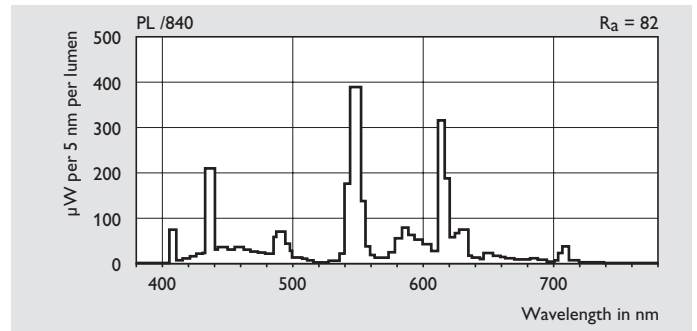
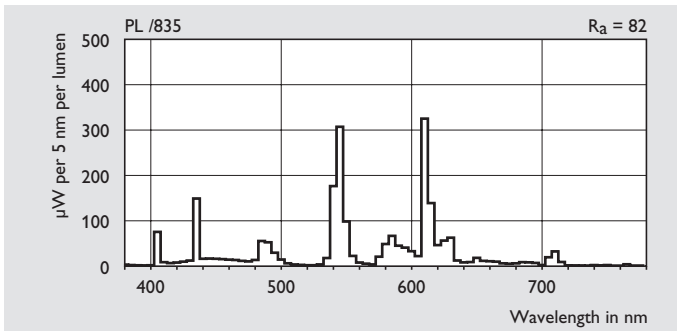
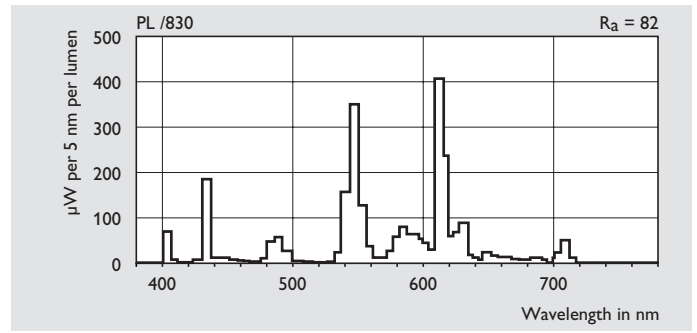
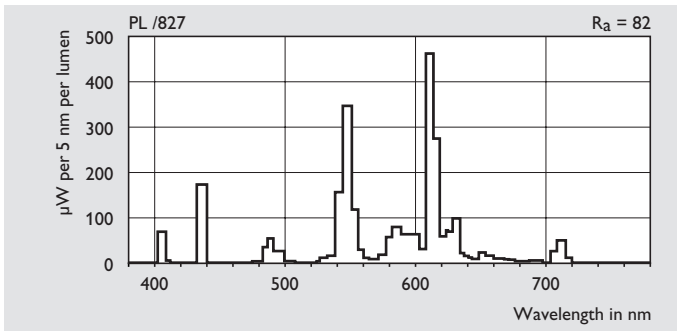

Spectral power distributions

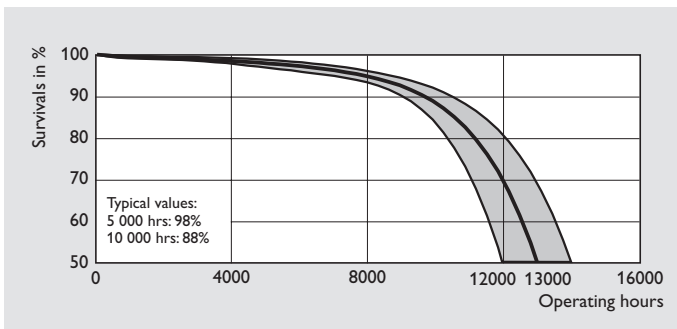

Life expectancy  
2

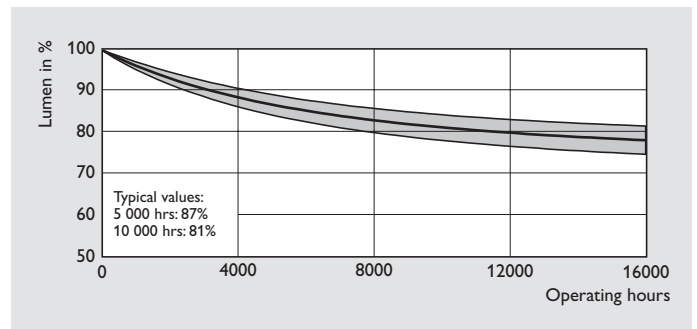

Lumen maintenance



**PHILIPS**