

P130431

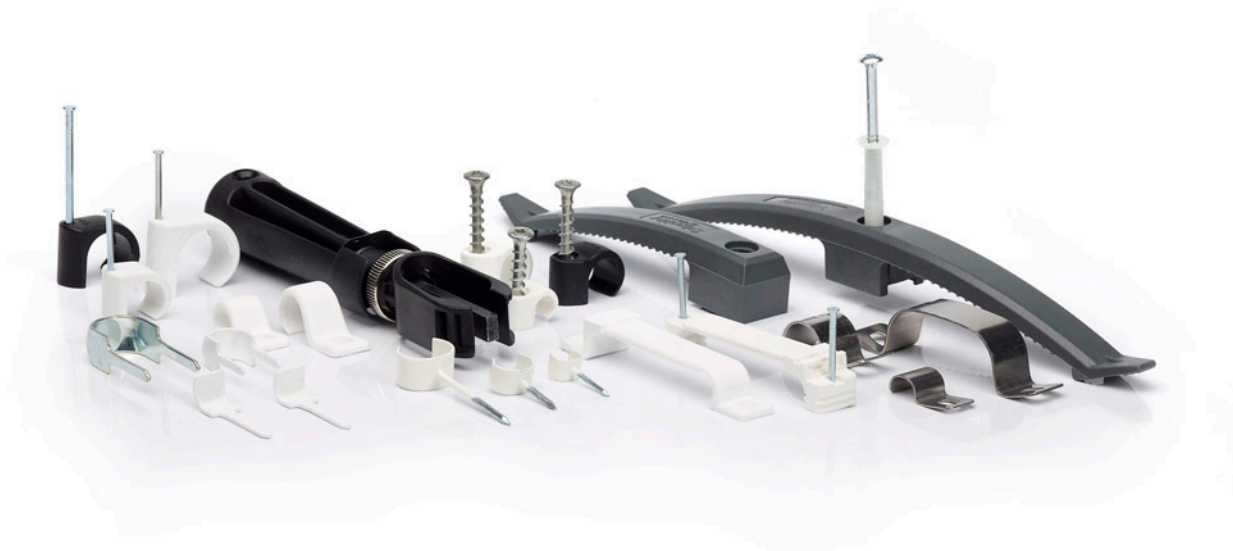

Thorsman TC™ Nail clips	Page 2
Thorsman TCS™ Screw clips	Page 6
Thorsman KLEMMI™ TKK/APK Metal clamps & Mounting tools ...	Page 8
Thorsman FASTIS™ TFK Metal clamps	Page 11
Thorsman TK Plastic clamps	Page 13
Thorsman TSK & PFSK Adjustable plastic clamps	Page 14
Thorsman Cable wings	Page 15
Thorsman TKS Stainless steel clamps	Page 16



Description

The Thorsman TC clip range includes a wide range of clips in various designs and dimensions, colours, nails and packages, intended for the installation of round and flat cables. The packages of the clips are provided with colour pictures of the correct product.

Clips in corrosivity category TC-C5M have a nail of acid-resistant stainless steel and can be used in extra tough environments.

The TCD type is intended for the installation of two flat cables side by side.

The clips are made of impact-resistant, UV-stabilized polypropylene.

Cable capacity

Cable dimensions according to each type name respectively. A minus (-) in the name states clips for round cables, (x) states clips for flat cables.

Material data

Material	Clip: impact resistant, UV-stabilized PP (polypropylene), halogen-free.	
	Nails:	
	• Hardened and electroplated steel, zinc coating (5 µm).	
	• Acid-proof stainless steel acc. to AISI 316, corrosivity category C5M.	

Colours	Colour	NCS-No.
	White	0500
	Grey	5402-Y
	Light grey	2502-Y
	Black	9500
	Brown	9005-Y20R
	Red	1090-Y90R

Operative data

Temperature range	-40°C to +80°C.	
Temperature range	Installation:	-20°C / +50°C
	In operation:	-40°C / +80°C

Standards and certificates

Standards and regulations	<ul style="list-style-type: none"> • Building regulations issued by National Board of Housing, Building and Planning (BBR) • Nail of acid-proof stainless steel: AISI 316
---------------------------	---

Mounting instruction

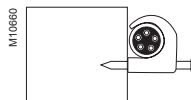

Wood and compressed board:
Nail in.
Thick nails in brick joints.

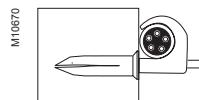

Concrete, low-density materials, brick, etc: Use TCP clip plugs. Hammer the clip plug into low-density concrete without predrilling. Not for thick nails.

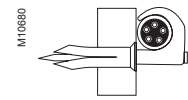

Plasterboard: Use TCP clip plugs. Make a hole in single plasterboard sheets with an awl. The start of a hole is sufficient in double plasterboard sheets.

Range Round clips

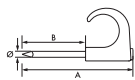

Type	Colour	Dimensions Nail Ø/A/B (mm)	Qty per package	EAN code	Ref. No.
Plastic clip including nail, for installations of round cables, mainly for indoor use. Material: Clip of PP, nail of hardened and electroplated steel.					
TC 2-3					
TC 2-3	Clear	1.4/15/11	100	7315882001001	2001008
TC 3-5					
TC 3-5	Clear White Grey Black	1.2/20/15	100	7315882011000 7315882011017 7315882011024 7315882011031	2011005 2011017 2011021 2011030
TC 4-6					
TC 4-6	Clear White Grey	1.4/20/14	100	7315882015107 7315882015114 7315882015121	2015105 2015110 2015121
TC 5-7					
TC 5-7	Clear White Grey Black Light grey	1.2/20/12	100	7315882021009 7315882021016 7315882021023 7315882021047 7332418021227	2021004 2021012 2021020 2021046 2021995
TC 5-7	Clear White Black Grey Light grey	2.0/25/17	100	7315880032267 7315882022013 7315880030577 7315882022037 3606480376023	2022009 2022010 2022029 2022030 IMT49000
TC 7-10					
TC 7-10	White Grey Light grey Black Brown	1.6/25/16	100	7315882032012 7315882032029 7315882032036 7315882032043 7315882032104	2032019 2032027 2032035 2032043 2032100
TC 7-10	White Light grey	1.6/30/21	100	7315882033019 7315882033033	2033017 2033033
TC 7-10	White Black Red Brown Light grey	2.0/25/16	100	7315880029014 7315880029113 7315880029137 7315882032098 3606480376030	2032011 2032041 2032061 2032091 IMT49001
TC 8-12					
TC 8-12	White Light grey Black Grey Brown	2.0/30/19	100	7315882041205 7315882041212 7315882041243 7315882041250 7315882041267	2041200 2041218 2041240 2041259 2041267
TC 8-12	Light grey	2.0/35/24	100	7315882041274	2041274
TC 8-12	White	2.0/45/34	100	7315882041281	2041283
TC 10-14					
TC 10-14	White Grey Light grey Black	2.0/30/17	100	7315882042011 7315882042028 7315882042035 7315882042042	2042018 2042026 2042034 2042042
TC 10-14	White Light grey	2.0/35/22	100	7315882043018 7315882043032	2043016 2043032
TC 10-14	White	2.0/45/32	100	7315882045012	2045012
TC 10-14	White Grey Black	2.5/30/17	100	7315880029021 7315880029151 7315880029168	2042011 2042021 2042041
TC 14-20					
TC 14-20	White Grey Light grey	2.0/35/18	100	7315882052010 7315882052027 7315882052034	2052017 2052025 2052033
TC 14-20	Black White Light grey	2.0/45/28	100	7315882052058 7315882053017 7315882053031	2052058 2053015 2053031
TC 14-20	White Black Light grey	2.5/35/18	100	7315880029038 7315880029212 3606480376047	2052011 2052051 IMT49002
TC 18-22					
TC 18-22	White Light grey Black	2.5/45/25	50	7315882060008 7315882060022 7315882060138	2060002 2060028 2060135
TC 18-22	Black	2.5/55/35	50	7315882060145	2060143

P79667



P79670



P79656



P79655
P79651



P79658



Range Round clips

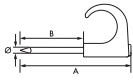

Type	Colour	Dimensions Nail Ø/A/B (mm)	Qty per package	EAN code	Ref. No.
------	--------	-------------------------------	--------------------	----------	----------

Plastic clip including nail, for installations of round cables, mainly for indoor use.
Material: Clip of PP, nail of hardened and electroplated steel.

TC 22-26

TC 22-26	White	2.5/45/21	50	7315882070007	2070001
	Light grey			7315882070021	2070027
	Black			7315882070137	2070134
TC 22-26	Black	2.5/55/31	50	7315882070144	2070142
	White			7315882070205	2070209
	Light grey			7315882070212	2070217

Round clips in corrosivity category C5M

Plastic clip including nail, for installations of round cables, for indoor or outdoor use. Corrosivity category C5M. Especially suited for tough environments.

Material: Clip of PP, nail of acid-proof stainless steel.

TC-C5M 5-7	Black	1.2/20/12	100	7315882240035	2240030
TC-C5M 7-10	White	1.6/25/16	100	7315882240042	2240045
	Black			7315882240059	2240050
TC-C5M 8-12	White	2.0/30/19	100	7315882240066	2240065
TC-C5M 10-14	White	2.0/30/17	100	7315882240080	2240085
	Black			7315882240097	2240090
TC-C5M 14-20	White	2.0/35/18	100	7315882240103	2240105
	Black			7315882240110	2240115
TC-C5M 14-20	Light grey	2.0/45/28	100	7332418016643	2240120
TC-C5M 18-22	Grey	2.5/45/25	50	7315882240158	2240150
TC-C5M 22-26	Grey	2.5/45/21	50	7315882240189	2240180

Range Flat clips

Plastic clip including nail, for installations of flat cables, mainly for indoor use.
Material: Clip of PP and nail of hardened and electroplated steel.

TC 2x4

TC 2x4	Clear	1.4/15/11	100	7315882101008	2101004
--------	-------	-----------	-----	---------------	---------

TC 3x5

TC 3x5	Clear	1.2/20/15	100	7315882106003	2106003
--------	-------	-----------	-----	---------------	---------

TC 4x6

TC 4x6	Clear	1.4/20/14	100	7315882111007	2111003
--------	-------	-----------	-----	---------------	---------

TC 5x8

TC 5x8	White	2.0/25/18	100	7315882116026	2116010
	Grey			7315882116019	2116028

TC 6x10

TC 6x10	White	2.0/25/17	100	7315882126018	2126019
	Grey			7315882126025	2126027

TC 7x14

TC 7x14	White	2.0/25/16	100	7315880042075	2131010
TC 7x14	White	2.5/25/16	100	7315882131012	2131019
	Grey			7315882131029	2131027
	Light grey			7315882131036	2131036

TC 9x18

TC 9x18	White	2.0/30/18	100	7315880042082	2136010
TC 9x18	White	2.5/30/18	100	7315882136017	2136018
	Grey			7315882136024	2136026

TC 11x22

TC 11x22	White	2.5/35/20	50	7315882137014	2137014
----------	-------	-----------	----	---------------	---------

Flat clips in corrosivity category C5M

Plastic clip including nail, for installations of flat cables, for indoor or outdoor use. Corrosivity category C5M. Especially suited for tough environments.

Material: Clip of PP, nail of hardened and Fe/Zn electroplated steel.

TC-C5M 6x9	White	1.6/25/17	100	7332418016650	2230972
------------	-------	-----------	-----	---------------	---------

Flat clips for two cables

Plastic clip including nail. For installations of two flat cables, mainly for indoor use.
Material: Clip of PP and nail of hardened and electroplated steel.

TCD 5x8

TCD 5x8	Grey	2.5/25/18	100	7315882141028	2141026
---------	------	-----------	-----	---------------	---------

TCD 6x10

TCD 6x10	Grey	2.5/25/18	100	7315882146603	2146025
----------	------	-----------	-----	---------------	---------

Range Round clips, bulk

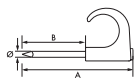

Type	Colour	Dimensions Nail Ø/A/B (mm)	Qty per package	EAN code	Ref. No.
Plastic clip including nail, for installation of round cables in indoor use. In bulk package. Material: Clip of PP, nail of hardened and electroplated steel.					
TC 3-5					
TC 3-5	White	1.2/20/15	2000	7315882201098	2201090
	Clear		5000	7315882011208	2011208
TC 5-7					
TC 5-7	White	1.2/20/12	2500	7315882021085	2021087
	Clear		2500	7315882021702	2021706
	Black		2500	7332418021159	2021710
TC 7-10					
TC 7-10	White	1.6/25/16	2500	7315882032715	2032712
	Black		2500	7332418021234	2032740
TC 7-10	White	1.6/30/21	2000	7332418021166	2203080
TC 8-12					
TC 8-12	White	2.0/30/19	1000	7315882041700	2041700
TC 10-14					
TC 10-14	Light grey	2.0/30/17	1250	7315882042080	2042083
	White		1000	7315882042714	2042711
TC 10-14	White	2.0/35/22	1000	7332418021180	2205080
TC 10-14	White	2.0/45/32	1000	7332418021173	2205070
TC 14-20					
TC 14-20	Light grey	2.0/35/18	400	7315882052065	2052066
TC 14-20	White	2.0/35/18	500	7315882206093	2206090
TC 14-20	White	2.0/45/28	500	7332418021197	2206080

Range Flat clips, bulk

Plastic clip including nail, for installation of flat cables in indoor use. In bulk package.
Material: Clip of PP and nail of hardened and electroplated steel.

TC 2x4					
TC 2x4	Clear	1.4/15/11	5000	7315882101015	2101015
TC 3x5					
TC 3x5	Clear	1.2/20/15	5000	7315882106706	2106706
TC 3x5	Bronze	1.2/20/15	5000	7315882106720	2106720
TC 3x5	Black	1.2/20/15	5000	7332418021241	2106994
TC 3x5	White	1.2/20/15	5000	7332418021258	2106995
TC 4x6					
TC 4x6	Clear	1.4/20/14	25000	7315882111014	2111011
TC 5x8					
TC 5x8	White	2.0/25/18	30000	7315882116194	2116192
TC 6x10					
TC 6x10	White	2.0/25/17	2000	7315882126711	2126711

Plastic clip including nail, for installation of flat cables in indoor or outdoor use. Especially suited for tough environments. In bulk package.
Material: Clip of PP and nail of acid-proof stainless steel.

TC 6x9					
TC-C5M 6x9	White	1.6/25/17	2000	7332418018364	2121204



Description

The screw fixing clips TCS-C3 and TCS-C5M can be used both for indoor and outdoor applications. TCS-C5M is the obvious choice in harsh environments.

Both TCS-C3 and TCS-C5M consist of a clip in impact-resistant polypropylene with high UV-resistance. C3 is provided with an electroplated steel screw, whereas C5M is provided with an acid-proof stainless steel screw. The screw has a high pitch for quick installation and a sharp point, and the head is cross-slotted of either type Phillips 2 or of type T20. It penetrates directly into most materials. In concrete and bricks it only needs a 4 mm hole.

The C3 T20 screw is specially suited for high torque applications like hard wood and concrete.

Applications

The clip can be fitted without drilling in double and single plasterboard, wood, board materials and low-density concrete with high density. It is also suitable for hard materials like concrete or bricks.

Benefits

- Type-approved
- Corrosion-classified screws
- High UV-resistance
- Can withstand high impact together with extremes of heat, cold and acids. C5M suitable for extra harsh environments.
- Documented quality
- Pre-mounted screw with high pitch and Phillips PH2 or T20 head for quick and secure installation with cordless driver
- Direct fixing in suitable materials without the use of wall plugs.
- Excellent function when installing cables or conduits on plasterboard with an underlying sheet steel frame
- Excellent function when installing rigid cables bent at small bending radii, for example around external corners.
- The screw length of TCS 14-18, 18-22 and 22-26 is adapted so as not to pass through a double 13 mm plasterboard (not C5M)
- Wide range of clips in several colours
- Flexible design – one size fits multiple cable dimensions
- Durable and recyclable packaging

Application examples

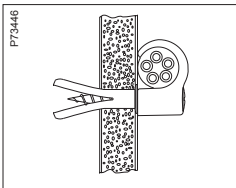

Mounting in single 13 mm plasterboard. Use plastic plug TP1 yellow.

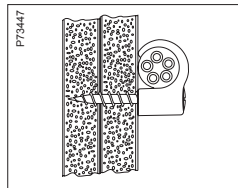

Mounting in double 13 mm plasterboard. The length of the screw of TCS-C3 14-18, 18-22 and 22-26 is adjusted so as not to pass through both boards, in order to facilitate the mounting of conduits from the inside of the wall.

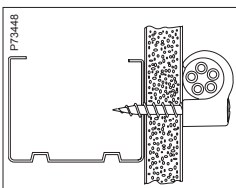

Mounting in a single 13 mm plasterboard with a metal bar behind, metal thickness 0.56 mm.

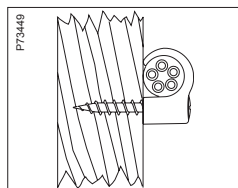

Mounting in wood, wood board materials, plywood.

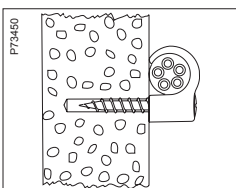

Mounting in concrete and bricks. Drill a \varnothing 4 mm hole, approx. 30 mm deep. Drive the screw direct in the drilled hole.

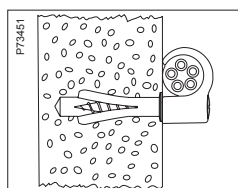

Mounting in low-density concrete. Use plastic plug TP1 yellow. In low-density concrete of higher density than 600, no pre-drilling or plugs are needed.

Material data

Clip	Material: Impact resistant, UV-stabilized PP (polypropylene)
	Colours: White NCS S 0500-N Black NCS S 9000-N Grey NCS S 4502-Y Light grey NCS S 2502-Y
Screw	Material: TCS-C3 Electroplated steel (Fe/Zn), corrosivity category C3 TCS-C5M Acid-proof stainless steel, corrosivity category C5M

Operative data

Temperature range	Installation: -20°C / $+50^{\circ}\text{C}$
	In operation: -40°C / $+80^{\circ}\text{C}$

Range



Type	Colour	Dimensions A/B/Ø (mm)	Qty per package	EAN code	Ref. No.
------	--------	-----------------------	-----------------	----------	----------

Screw C3 with PH head

Plastic clip with screw, intended for indoor or outdoor installations in walls and ceilings, with or without wall plug. Screw with surface treatment acc. to corrosivity class C3 and cross-slotted head type Phillips 2. For round cables. Material: PP/Steel.

TCS-C3 7-10 For 7-10 mm cables	White	32/23/5	100	7315880109945	2190001
	Light grey			7315880109938	2190003
	Grey			7315882190002	2190004
TCS-C3 8-12 For 8-12 mm cables	White	32/21/5	100	7332418015875	2190013
	Black			7332418015929	2190015
	Light grey			7332418015851	2190009
	Grey			7332418015868	2190011
TCS-C3 10-14 For 10-14 mm cables	White	38/26/5	100	7315880109839	2190021
	Black			7315882190026	2190022
	Light grey			7315880109822	2190023
	Grey			7315880109815	2190024
TCS-C3 14-18 For 14-18 mm cables	White	38/23/5	100	7315880109860	2190031
	Black			7315882190033	2190032
	Light grey			7315880109853	2190033
	Grey			7315880109846	2190034
TCS-C3 18-22 For 18-22 mm cables	White	41/23/5	50	7315880109891	2190041
	Black			7315882190040	2190042
	Light grey			7315880109884	2190043
	Grey			7315880109877	2190044
TCS-C3 22-26 For 22-26 mm cables	White	45/23/5	50	7315880109921	2190051
	Black			7315882190057	2190052
	Light grey			7315880109914	2190053
	Grey			7315880109907	2190054

Screw C3 with T20 head

Plastic clip with screw, intended for indoor or outdoor installations in walls and ceilings, with or without wall plug. Screw with surface treatment acc. to corrosivity class C3 and cross-slotted head type T20. For round cables. Material: PP/Steel.

TCS-X-C3 7-10 For 7-10 mm cables	White	32/23/5	100	7332418019507	2191000
	Light grey			7332418019491	2191005
TCS-X-C3 8-12 For 8-12 mm cables	White	32/21/5	100	7332418019538	2191010
	Black			7332418019514	2191015
	Light grey			7332418019521	2191020
TCS-X-C3 10-14 For 10-14 mm cables	White	38/26/5	100	7332418019392	2191025
	Black			7332418019378	2191030
	Light grey			7332418019385	2191035
TCS-X-C3 14-18 For 14-18 mm cables	White	38/23/5	100	7332418019422	2191040
	Black			7332418019408	2191045
	Light grey			7332418019415	2191050
TCS-X-C3 18-22 For 18-22 mm cables	White	41/23/5	50	7332418019453	2191055
	Black			7332418019439	2191060
	Light grey			7332418019446	2191065
TCS-X-C3 22-26 For 22-26 mm cables	White	45/23/5	50	7332418019484	2191070
	Black			7332418019460	2191075
	Light grey			7332418019477	2191080

Screw C5M with PH head

Plastic clip with screw, intended for indoor or outdoor installations in walls and ceilings, with or without wall plug. Acid-proof stainless steel screw acc. to corrosivity class C5M and cross-slotted head type Phillips 2. For round cables. Material: PP/Steel (acid-proof, stainless).

TCS-C5M 7-10 For 7-10 mm cables	White	32/24/5	100	7332418020732	2191509
	Light grey				
TCS-C5M 8-12 For 8-12 mm cables	Light grey	32/21/5	100	7332418020688	2191504
	White			7332418020749	2191510
TCS-C5M 10-14 For 10-14 mm cables	Black	32/21/5	100	7332418020640	2191500
	Light grey			7332418020695	2191505
	White			7332418020756	2191511
TCS-C5M 14-18 For 14-18 mm cables	Black	41/26/5	100	7332418020657	2191501
	Light grey			7332418020701	2191506
	White			7332418020763	2191512
TCS-C5M 18-22 For 18-22 mm cables	Black	41/23/5	50	7332418020664	2191502
	Light grey			7332418020718	2191507
	White			7332418020770	2191513
TCS-C5M 22-26 For 22-26 mm cables	Black	41/20/5	50	7332418020671	2191503
	Light grey			7332418020725	2191508
	White			7332418020787	2191514

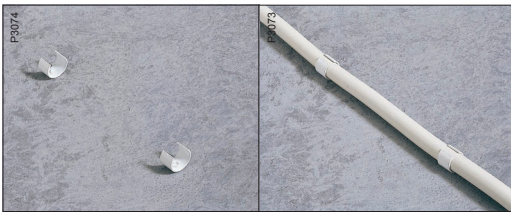

Description clamps

TKK/APK powder-coated metal clamps are intended for surface mounted installations of round and flat electric cables.

The powder coating provides very good resistance to corrosion and mechanical influence, and good resistance to heat and sunlight.

For some cable dimensions the clamp is available with various lengths of nail and with a thicker screw-nail.

The clamps are packed in cartons provided with a clear colour coding system.

Plugs of type TCP can be used together with the clamps.

Benefits

- Excellent outdoor durability thanks to very good resistance to heat and sunlight
- Good resistance to corrosion and mechanical influence
- Flexible, thin material, powder coated in the colour of the cable, giving a very neat installation without projecting parts

Material data

Strap	Steel SIS 1151 Z200, electroplated (Fe/Zn 10)
Surface	Powder coated with polyester varnish, layer thickness 120–160 µm
Colour	White NCS 0502-Y
Nail, screw	Steel SIS 1151 Z275, electroplated (Fe/Zn 7)
Plug	PEHD (polythene)

Operative data

Temperature range	From -40° to +250°C
Suitable outdoors	Yes. Excellent outdoor durability thanks to very good resistance to heat and sunlight.

Description tools

Mounting tools for Klemmi clamps TKK/APK.

Handles with exchangeable heads

- TKK-MD, ergonomic handle with optional adjustment of the angle of the head to the handle. Supplied with three exchangeable heads.
- TKK-N, simple straight handle providing easy accessibility where space is limited. Supplied with three exchangeable heads.

For both handles there are four easily exchangeable heads covering our whole range of TKK/APK clamps.

The head gives a very good control of the clamp. On the side of the head there is a clear marking to show which clamp size the head is intended for.

Handle for round clamps

TKK-S, the same handle as TKK-N but in black colour. Supplied with one mounting head for round cables.

Nailing tools

- TKK-E is a simple tool for the nailing of clamp sizes 6x9, 7–10 and 10–14. The narrow end of the tool is suitable for 6x9 and 7–10 and the thicker end for 10–14.
- TKK-Y has a clamp holder with spring action, shaped as pincers, and an adjustable mandrel. TKK-Y can handle all dimensions in the TKK/APK range.

Material data

TKK-Y	Handle	Black PA6 (polyamide) with 30% glass-fibre
	Pincers	Black acetaldehyde resin (POM)
	Impact mandrel	Hardened steel
TKK-E	Nut	Electroplated brass
	Material	PA6 (polyamide)
TKK-N, -MD, -NT and -S	Colour	Red NCS 2080 R
	Handle	PA, glass-fibre reinforced
	Head	Die-cast zinc
	Mandrels, springs and sleeves	Steel
	Colour	• Blue NCS 6040-R80B (TKK-N, -MD, -NT) • Black (TKK-S)

Installation

Install by hand with nailing tool TKK-Y or -E or with mounting tools TKK-S, -N, -MD or -NT.

Concrete, low-density concrete, brick, etc.: use TCP clip plug. In low density concrete, drive the TCP plug in without pilot drilling.

Plasterboard: use TCP clip plug. In single board, make a hole with an awl. In double board sheets it is sufficient to start a hole.

Mounting instruction

For TKK-MD and TKK-N, printed on the package.







Range Clamps

Type	Nail ØxL	Dimensions A/B (mm)	Qty per package	EAN code	Ref. No.		
Clamps for indoor and outdoor installations of round and flat electric cables. Material: Powder coated, electroplated sheet steel. Colour: White.							
Clamps for round cables							
P126000		TKK/APK 4-6 18	1.6x18	6/7	100	7315882366100	2366102
P126002		TKK/APK 5-7 18	1.6x18	7.5/7	100	7315882366209	2366209
P126003		TKK/APK 5-7 25	1.6x25	7.5/7	100	7315882366230	2366230
P126016		TKK/APK 7-10 18	2.1x18	10/8	100	7315882367015	2367019
		TKK/APK 7-10 18 bulk	2.1x18	10/8	5000	7315880061588	2367020
		TKK/APK 7-10 25	2.1x25	10/8	100	7315882369019	2369015
		TKK/APK 7-10 25 bulk	2.1x25	10/8	5000	7315882369002	2369000
		TKK/APK 7-10 screw 25 TKK/ APK 7-10 40	2.7x25 2.1x40	10/8 10/8	100 100	7315882375010 7315882369026	2375012 2369020
P126009		TKK/APK 8-12 18	2.1x18	11/9	100	7315882369200	2369200
		TKK/APK 8-12 25	2.1x25	11/9	100	7315882369231	2369231
		TKK/APK 8-12 40	2.1x40	11/9	100	7315882369262	2369262
		TKK/APK 8-12 screw 25	2.7x25	11/9	100	7315882369316	2369310
P126012		TKK/APK 10-14 25	2.1x25	13/10	100	7315882371012	2371011
		TKK/APK 10-14 screw 25 TKK/ APK 10-14 40	2.7x25 2.1x40	13/10 13/10	100 50	7315882377014 7315880101574	2377018 2371013
P126018		TKK/APK 14-20 25	2.1x25	17/12	50	7315882373016	2373017
		TKK/APK 14-20 screw 25 TKK/ APK 14-20 40	2.7x25 2.1x40	17/12 17/12	50 50	7315882379018 7315882373023	2379014 2373020
Clamps for flat cables							
P126021		TKK/APK 6x9 18	2.1x18	9/8	100	7315882380007	2380004
P126022		TKK/APK 6x9 18 bulk	2.1x18	9/8	5000	7315882380014	2380010
P126023		TKK/APK 6x9 25	2.1x25	9/8	100	7315882380052	2380053
		TKK/APK 6x9 25 bulk	2.1x25	9/8	5000	7315882380069	2380060
		TKK/APK 6x9 screw 25	2.7x25	9/8	100	7315882380113	2380110
P126024		TKK/APK 6x12 25	2.1x25	10/10	100	7315882380151	2380152

Range Tools

Type	Colour	Dimensions A/B/C (mm)	Qty per package	EAN code	Ref. No.		
Mounting tools							
Mounting tool kit including handle and exchangeable heads. TKK-N and TKK-MD include three exchangeable heads, whereas TKK-S includes one head for the clamp dimensions 7-10, 8-12, 10-14 and 14-20. The head of TKK-MD can be angled to the handle. TKK-NT is supplied without mounting heads. Material: PA, die-cast zinc, steel.							
P80851		TKK-N	Blue	30/27/135	1	7315882360030	2360030
P80825		TKK-S	Black	30/27/135	1	7315880084808	2360018
P80850		TKK-MD	Blue	68/30/165	1	7315880052555	2360035
P80855		TKK-NT	Blue	28/28/135	1	7315882360023	2360025

Range Tools

Type	Colour	Dimensions A/B/C (mm)	Qty per package	EAN code	Ref. No.
Exchangeable heads					
Exchangeable head for TKK mounting tools, suitable for TKK-N, TKK-MD and various sizes of clamps, see below. Material: Die-cast zinc, steel.					
P80846 	—	14/10/50	1	7315880052562	2360040
P80854 	—	16/13/52	1	7315880052579	2360041
P80853 	—	18/15/52	1	7315880052586	2360042
P80852 	—	20/16/52	1	7315880052593	2360043
Nailing tools					
Tool with spring-action clamp holder and adjustable mandrel. Suitable for all dimensions in the TKK/APK range. Material: PA6, POM, steel, brass.					
P80849 	Black	Ø28/—/140	1	7315882360009	2360009
Simple tool for nailing of TKK/APK clamps. Suitable for TKK/APK 7-10, 10-14 and 6x9. Material: PA6.					
P80847 	Red	12/13/66	1000	7315880036203	2360020



Description

The metal clamp range FASTIS TFK is intended for use when fixing cables and conduits.

The clamp has a bent part to hold the cable/conduit and one or two integrated nails to fix it.

TFK clamps are available with white plastic-coating or in electroplated steel, in the latter case only in the bigger sizes Ø16 and Ø20 mm. The plastic-coated clamps are in corrosivity category C4, whereas the electroplated steel clamps are in category C2.

The one-nailed clamps need specially adapted mounting tools to hold the clamp and the cable in position when driving the clamp in, the two-nailed clamps only need a hammer.

Applications

The clamps are suitable for stationary installations of cables and conduits in wood or wood-based materials, indoors as well as outdoors. Typical are visible installations in houses and flats. The long-nailed clamps are used when nailing through board materials and thin panels into the underlying wooden framework.

The one-nail clamps are mainly to be used in corners and transitions between floor and wall, wall and ceiling, wall and wall, and on skirting-boards. The clamps with two nails are used on walls and ceilings without support from a corner. In solid wood material, only clamps with short nails should be used.

The clamps are mainly intended for cables of EKRK type for the Swedish market, and of PR type for the Norwegian market. The two-nail clamp sizes 16 and 20 mm are specially suited for flexible or rigid conduits, often in concealed installations.

Benefits

- Neat and slim installations.
- Impact-resistant polyamide (Rilsan®) plastic-coating.
- White plastic-coating well suited to the colour of the cable.
- Plastic-coated clamps in corrosivity category C4.
- Electroplated steel clamps in corrosivity category C2.

Standards and regulations

- Corrosivity category C2 in accordance with ISO 4042.
- Corrosivity category C4 in accordance with SS-EN ISO 12944-2.

Certificates

C4 classified clamps SITAC¹⁾ Technical Approval of corrosion protection, No. 0035/04

¹⁾Swedish Institute for Technical Approval in Construction

Material and Operative data

Clamp	Material	Hardened steel
	Surface treatment:	Plastic-coating MaxiCoat Rilsan® PA11
	Colour	White
Clamp Ø16 and 20	Material	Hardened and electroplated steel
Mounting tool	Material	PP and electroplated steel
Temperature range		From -40°C to +150°C

Installation

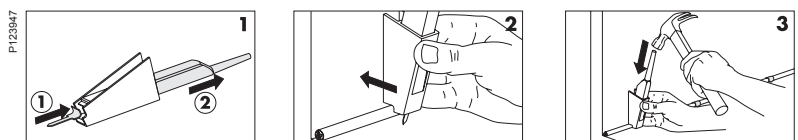

Range Clamps, plastic-coated

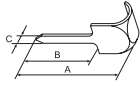

P125909
P125900



Type	Colour	Dimensions A/B/C (mm)	Qty per package	EAN code	Ref. No.
Clamp with one nail for round cables					
Clamp with one nail, intended for use in stationary installations of round cables. Mounted with mounting tool TFK-F1 (TFK-C4 8-9) or TFK-F2 (TFK-C4 10-11) and a hammer. The steel clamp is plastic-coated for corrosion resistance and impact protection. In solid wood, use only clamps with 16 mm nail. Corrosivity category C4. Material: Hardened steel, plastic-coated.					
TFK-C4 8-9 16 mm nail	White	25/16/3	100	7332418016834	2150010
TFK-C4 8-9 25 mm nail	White	34/25/3.5	100	7332418016841	2150015
TFK-C4 10-11 16 mm nail	White	27/16/3	100	7332418016728	2150020
TFK-C4 10-11 25 mm nail	White	36/25/3.5	100	7332418016735	2150025

P125903



Clamp with two nails for round cables					
Clamp with two nails, intended for use in stationary installations of round cables. Mounted with a hammer. The steel clamp is plastic-coated for corrosion resistance and impact protection. Corrosivity category C4. Material: Hardened steel, plastic-coated.					
TFK-C4 8-9 16 mm nail	White	26/16/3	100	7332418016827	2150030
TFK-C4 10-11 16 mm nail	White	27/16/3	100	7332418016711	2150035

P125909
P125910



Clamp with one nail for flat cables					
Clamp with one nail, intended for use in stationary installations of flat cables. Mounted with mounting tool TFK-F3 and a hammer. The steel clamp is plastic-coated for corrosion resistance and impact protection. In solid wood, use only the clamp with 16 mm nail. Corrosivity category C4. Material: Hardened steel, plastic-coated.					
TFK-C4 6x9/10 16 mm nail	White	23/16/3	100	7332418016803	2150085
TFK-C4 6x9/10 25 mm nail	White	32/25/3.5	100	7332418016810	2150090

P125911



Clamp with two nails for flat cables					
Clamp with two nails, intended for use in stationary installations of flat cables. Mounted with a hammer. The steel clamp is plastic-coated for corrosion resistance and impact protection. Corrosivity category C4. Material: Hardened steel, plastic-coated.					
TFK-C4 6x9 16 mm nail	White	23/16/3	100	7332418016797	2150095
TFK-C4 6x10 16 mm nail	White	23/16/3	100	7332418016780	2150110

P99606



Mounting tool					
Mounting tool marked with one groove, for TFK-C4 8-9 clamps with one nail for round cables. A strong magnet holds the clamp in a steady position. To be used together with a hammer. Material: PP/Electroplated steel.					
TFK-F1	Green/black	120/18/36	1	7332418021203	2150126

P124810



Mounting tool marked with two grooves, for TFK-C4 10-11 clamps with one nail for round cables. A strong magnet holds the clamp in a steady position. To be used together with a hammer. Material: PP/Electroplated steel.					
TFK-F2	Green/bright	120/18/36	1	7332418021210	2150127

P126999



Mounting tool marked with three grooves, for TFK-C4 6x9/10 clamps with one nail for flat cables. A strong magnet holds the clamp in a steady position. To be used together with a hammer. Material: PP/Electroplated steel.					
TFK-F3	Green/black	120/18/36	1	7332418021579	2150128

Range Clamps, electroplated

P126907
P126908



Clamp with two nails for round cables or conduits					
Clamp with two nails, intended for use in stationary installations of round cables or conduits. Mounted with a hammer. The steel clamp is electroplated. In solid wood, use only the clamps with 16 mm and 20 mm nails. Corrosivity category C2. Material: Hardened steel, electroplated.					
TFK 16 16 mm nail	—	33/16/3	50	7332418016865	2150060
TFK 16 25 mm nail	—	42/25/3	50	7332418016872	2150065
TFK 20 20 mm nail	—	41/20/3	50	7332418016889	2150070
TFK 20 28 mm nail	—	49/28/3	50	7332418016896	2150075



Description

Plastic clamps for round and flat cables/conduits.

Applications

Installations in wood is done by using wood screw. For installations in concrete, brick, plasterboard, etc., use TP plugs and wood screws, or TPS nail plugs.

Benefits

- Flexible – each size can be used for several cable/conduit sizes
- Can withstand high impact, together with extremes of heat, cold and acid
- Broad range

Material data

Material	Impact resistant polypropylene (PP)
Temperature range	From -40° to +80°C

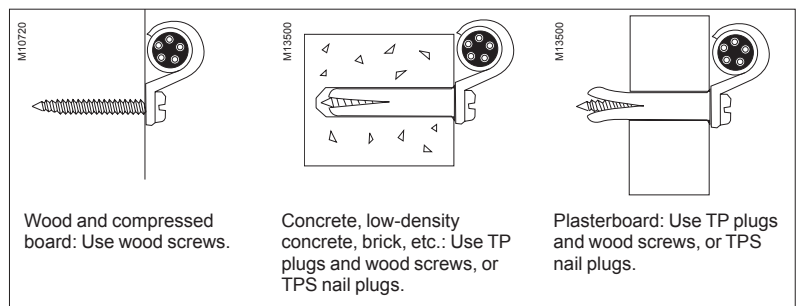

Technical data

Type	Required screw No.	Suitable plug Plug	Nail plug
TK 3-5	6	TP0, TP1, TP2	TPS-4
TK 5-7	6	TP0, TP1, TP2	TPS-4
TK 7-10	6	TP0, TP1, TP2	TPS-4
TK 10-14	6-8	TP0, TP1, TP2	TPS-4
TK 14-20	8-10	TP0, TP1, TP2	TPS-5
TK 20-26	8-10	TP0, TP1, TP2	TPS-5
TK 6x9	6	TP0, TP1, TP2	TPS-4

Range

P60821



Type	Colour	Dimensions A/B/C (mm)	Qty per package	EAN code	Ref. No.
Plastic clamp for round and flat cables or conduits. Installation in wood is done by using wood screws. For installations in concrete, brick, plasterboard, etc., use TP plugs and wood screws, or TPS nail plugs. Material: PP(polypropylene).					
TK 3-5	White	6/15/9	100	7315882300012	2300010
TK 5-7	White	8/18/9	100	7315882301019	2301018
TK 7-10	White	11/20/9	100	7315882302016	2302016
	Grey			7315882302023	2302024
TK 10-14	White	14/27/13	100	7315882303013	2303014
	Grey			7315882303020	2303022
TK 14-20	White	19/35/14	100	7315882304010	2304012
	Grey			7315882304027	2304020
TK 20-26	White	25/47/15	50	7315882305017	2305019
TK 6x9	White	19.5/9/7	100	7315882310103	2310100

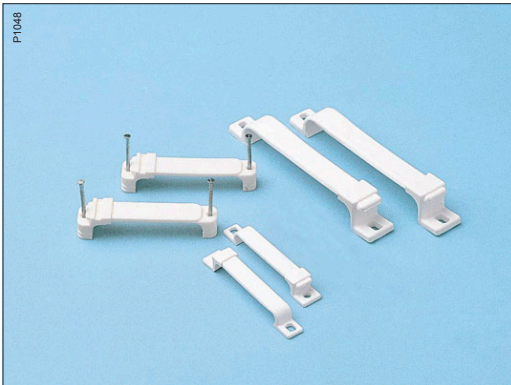

Description

Adjustable plastic clamps for banks of electric cables.

Applications

Intended to secure banks of electric cables. Installations in wood is done by using wood screws. For installations in concrete, brick, plasterboard, etc., use TP plugs and wood screws, or TPS nail plugs.

Benefits

- Flexible – each size can be used for several cables of the same size
- One clamp can take 2-5 parallel cables
- Quick and easy to install
- Can withstand high impact, together with extremes of heat, cold and acid

Material data

Material	TSK:	Polypropylene (PP)
	PFSK:	Polyamide (PA)
	Nail:	Hardened zinc plated steel
Temperature range	From -40° to +80°C	

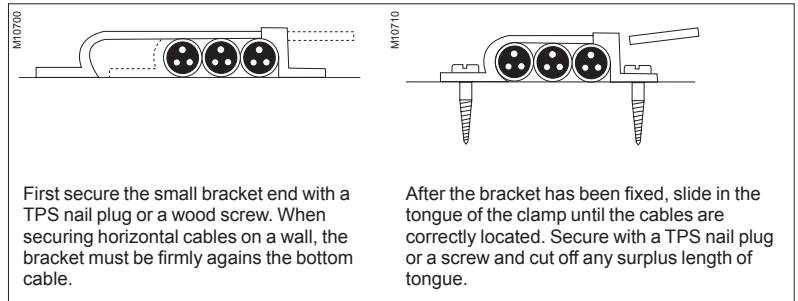

Technical data

Type	No. of cables	Required screw No.	Suitable plug Plug	Nail plug
TSK 7-10	2-5	6	TP0, TP1, TP2	TPS-4
TSK 10-14	2-5	6-8	TP0, TP1, TP2	TPS-5
TSK 14-20	2-5	8-10	TP0, TP1, TP2	TPS-5
PFSK 10-14	2-5	—	TCP0	—

Range

P80831



P80832



Type	Colour	Dimensions A/B/C (mm)	Qty per package	EAN code	Ref. No.
Clamp for screw installation					
Adjustable plastic clamp intended to secure banks of electric cables. For screw mounting. Material: PP (polypropylene).					
TSK 7-10	White	10/11/65	100	7315882330019	2330017
TSK 10-14	White	14/16/85	50	7315882332013	2332013
TSK 14-20	White	17/20/120	50	7315882334017	2334019
Clamp for nail installation					
Adjustable plastic clamp intended to secure banks of electric cables. For nail mounting, including nail. Material: PA(polyamide), steel.					
PFSK 10-14	White	16/31/72	50	7315882333430	2333433

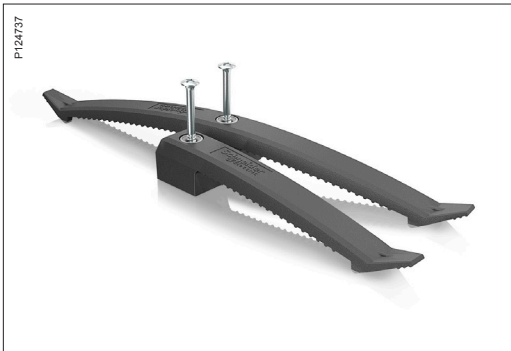

Description

The Cable Wing fixing clip can be used both for indoor and outdoor applications.

The Cable Wing is available both as a single clip for cable installation on one side only and as a double clip for cable/conduit installation on both sides.

Both types are made of polyamide with high UV-resistance and durability.

The Cable Wing is either provided with a nail-plug for quick installation in concrete/brick or is supplied without plug if for example a screw installation is preferred.

Benefits

- Fast installation with a hammer when using the nail plug
- Installs directly in suitable materials. In concrete and brick it is recommended to use a nail-plug.
- Nail plug installation means that the Cable Wing can be adjusted or even removed and re-used
- High UV-resistance
- Halogen-free
- Can withstand high impact together with extremes of heat and cold
- Documented quality
- Can be installed before adding cables, i.e. cables can easily be fixed or removed after installation of the clip
- Flexible design – one size fits multiple cable/conduit dimensions
- Recyclable packaging

Technical and Material data

Material	Cable wing, nail plug: PA (polyamide) Screw nail: Steel with electro-plated zinc surface treatment
Cable capacity	Maximum diameter 12 mm. Maximum capacity 6 cables per side.
Colour	Dark grey
Temperature range	From -20 to + 60°C
Recommended load	30 N

Range

Type	Colour	Dimensions A/B/C (mm)	Qty per package	EAN code	Ref. No.
Cable wing, double					
Cable wing, double. Intended for cable/conduit installation on both sides. Available with or without nail-plug. Material: PA.					
With nail-plug	Dark grey	23/20/230	25	3606480217227	IMT39080
Without nail-plug	Dark grey	23/20/230	10	3606480217210	IMT39079
Cable wing, single					
Cable wing, single. Intended for cable installation on one side. Available with or without nail plug. Material: PA.					
With nail-plug	Dark grey	20/20/130	25	3606480217203	IMT39078
Without nail-plug	Dark grey	20/20/130	10	3606480217197	IMT39077

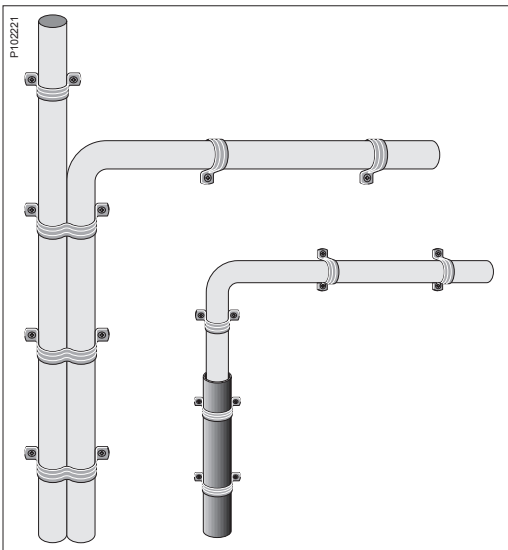

Description

The TKS range includes screw clamps intended for use in installations of cables and pipes/conduits. The range is available either in stainless steel in corrosivity category C4, or in acid-proof stainless steel in category C5M (a selected range). The products in the C5M range are marked TKS.

The screw clamp is available in four different designs:

- TKS-ER with two fixing holes, for mounting of one pipe or cable, both C4 and C5M.
- TKS-DR with two fixing holes, for mounting of two parallel cables or pipes of the same diameter, both C4 and C5M.
- TKS-KR with one fixing hole, for mounting of one pipe or cable, both C4 and C5M.
- TKS-MR with one fixing hole, for mounting of one pipe or cable, only C4. Made of extra thick material.

Benefits





- Long lasting installations
- Broad range
- Not influenced by UV light
- Clamps with two mounting holes for heavy installations
- C5M range for harsh environments
- Type approval for C5M range

Material and Operative data

Material data	Material:	Stainless steel AISI 304 (C4) and AISI 316 (C5M)
Operative data	Temperature range:	From -40°C to +250°C
	Suitable outdoors:	Yes
Approval	Swedish Technical Approval 0007/03 for C5M range	

Range, category C4

Type	Dimensions A/B/C (mm)		Qty per package	EAN code	Ref. No.
Screw clamps for one cable, two fixing holes					
Steel clamp, single, for installation of one pipe or cable. With two oval 8x5 mm fixing holes. Corrosivity category C4. Material: Stainless steel.					
TKS-ER 16	16/47/15		100	7315882390402	2390400
TKS-ER 20	20/58/15		100	7315880108092	2390405
TKS-ER 22	22/58/15		100	7315882390419	2390410
TKS-ER 25	25/64/15		100	7315880107941	2390415
TKS-ER 30	30/69/15		100	7315882390426	2390420
TKS-ER 32	32/73/15		50	7315880107958	2390425
TKS-ER 40	40/76/15		50	7315882390433	2390430
TKS-ER 50	50/85/15		50	7315880107965	2390435
Screw clamps for one cable, one fixing hole					
Steel clamp, single, for installation of one pipe or cable. With one 8x5 mm oval fixing hole. Corrosivity category C4. Material: Stainless steel.					
TKS-KR 8	8/25/12		100	7315882390501	2390500
TKS-KR 9	9/26/12		100	7315880107989	2390505
TKS-KR 10	10/26/15		100	7315882390518	2390510
TKS-KR 11	11/28/15		100	7315880107996	2390515
TKS-KR 12	12/30/15		100	7315882390525	2390520
TKS-KR 14	14/31/15		100	7315880108009	2390525
TKS-KR 16	16/34/15		100	7315882390532	2390530
TKS-KR 18	18/36/15		100	7315880108016	2390535
TKS-KR 20	20/39/15		100	7315882390549	2390540
TKS-KR 6x9	6/26/15		100	7315880108023	2390545
TKS-KR 6x10	6/22/15		100	7315882390556	2390550
Steel clamp, single, for installation of one pipe or cable. With one \varnothing 7 mm fixing hole. Made of extra thick material, suitable for heavy-duty installations. Corrosivity category C4. Material: Stainless steel.					
TKS-MR 6	6/23/15		100	7315882390594	2390595
TKS-MR 7	7/23/15		100	7315882390600	2390600
TKS-MR 8	8/25/12		100	7315880108030	2390605
TKS-MR 9	9/25/12		100	7315882390617	2390610
TKS-MR 10	10/27/15		100	7315880108047	2390615
TKS-MR 11	11/28/15		100	7315882390624	2390620
TKS-MR 12	12/29/15		100	7315880108054	2390625
TKS-MR 13	13/30/15		100	7315882390631	2390630
TKS-MR 14	14/31/15		100	7315880108061	2390635
TKS-MR 16	16/33/15		100	7315882390648	2390640
TKS-MR 18	18/36/15		100	7315880108078	2390645
TKS-MR 20	20/38/15		100	7315882390655	2390650
TKS-MR 22	22/39/15		100	7315880108085	2390655
TKS-MR 24	24/44/20		100	7315882390662	2390660
Screw clamps for two cables					
Steel clamp, double, for installation of two parallel pipes or cables of the same diameter. With two oval 8x5 mm fixing holes. Corrosivity category C4. Material: Stainless steel.					
TKS-DR 10	10/51/15		100	7315882390471	2390475
TKS-DR 12	12/53/15		100	7315882390488	2390480
TKS-DR 16	16/64/15		100	7315880107972	2390485
TKS-DR 20	20/71/15		100	7315882390495	2390490

Range, category C5M					
Type	Dimensions A/B/C (mm)		Qty per package	EAN code	Ref. No.
Screw clamps for one cable, two fixing holes					
Steel clamp, single, for installation of one pipe or cable. With two oval 8x5 mm fixing holes. Suitable for marine applications. Corrosivity category C5M. Material: Stainless steel, acid-proof.					
 P102712	TKS-ER-C5M 16	16/47/15	100	7332418018944	2390401
	TKS-ER-C5M 20	20/58/15	100	7332418018951	2390406
	TKS-ER-C5M 25	25/64/15	50	7332418018968	2390416
	TKS-ER-C5M 32	32/73/15	50	7332418018975	2390426
Screw clamps for one cable, one fixing hole					
Steel clamp, single, for installation of one pipe or cable. With one 8x5 mm oval fixing hole. Suitable for marine applications. Corrosivity category C5M. Material: Stainless steel, acid-proof.					
 P101913	TKS-KR-C5M 9	9/26/12	100	7332418019026	2390570
	TKS-KR-C5M 10	10/26/15	100	7332418018982	2390511
	TKS-KR-C5M 12	12/30/15	100	7332418018999	2390521
	TKS-KR-C5M 16	16/34/15	100	7332418019002	2390531
	TKS-KR-C5M 20	20/39/15	100	7332418019019	2390541
Screw clamps for two cables					
Steel clamp, double, for installation of two parallel pipes or cables of the same diameter. With two oval 8x5 mm fixing holes. Suitable for marine applications. Corrosivity category C5M. Material: Stainless steel, acid-proof.					
 P102713	TKS-DR-C5M 10	10/51/15	100	7332418018913	2390476
	TKS-DR-C5M 12	12/53/15	100	7332418018920	2390481
	TKS-DR-C5M 16	16/64/15	100	7332418018937	2390486
Installation screw					
Screw with large thin head and Phillips cross recess. Sharp point, twin steep-pitch thread. Fully threaded. Works in most materials — metal studwork, cabinets, wood, plugs. Fastened with Phillips screw-driver or power driver. Suitable for marine applications. Corrosivity category C5M. Material: Stainless steel, acid-proof.					
 P81316	TSC-C5M	4.2x25	100	7315883782268	3782260
		4.2x32	100	7315880115137	3782265