Thermostats type KP

Introduction

KP thermostats are temperature-controlled electrical switches. A KP thermostat has a single pole (SPDT) changeover switch.

The position of the switch depends on the thermostat setting and the bulb temperature.

A KP thermostat can be directly connected to single-phase a.c. motors of up to about 2 kW, or installed in the control current circuit of d.c. motors and large a.c. motors.



Features

- *Wide regulating range*
- *Can be used for deep freeze, refrigeration and air conditioning plant*
- *Welded bellows elements mean increased reliability*
- *Small dimensions*
Easy to install in refrigerated counters or cold rooms.
- *Ultra-short bounce times*
Long operating life.
Unnecessary cut-in and cut-out of control equipment is avoided.
- *Standard versions with changeover switch*
Possible to obtain opposite switch function or to connect a signal.
- *Electrical connection at the front of the unit*
Facilitates rack mounting.
Saves space.
- *Suitable for alternating and direct current*
- *Cable entry of soft thermoplastics for cables from 6 to 14 mm diameter.*
- *Extensive and wide range*

Approvals

- Ⓓ DEMKO, Denmark
- Ⓝ NEMKO, Norway
- Ⓕ FIMKO, Finland
- Ⓒ Germanischer Lloyd, Germany
- DSRK, Deutsche-Schiffs-Revision und -Klassifikation, Germany
- Ⓟ Polski Rejestr Statków, Poland
- DnV, Det norske Veritas, Norway

RINA, Registro Italiano Navale, Italy
BV, France
LR, UK
MRS, Maritime Register of Shipping, Russia
EZU, Czech Republic / Slovak Republic
CE according to EN 60730-2-1 to -9

Versions with UL and CSA approvals can be supplied to special order.

Thermostats, type KP

Regulating range

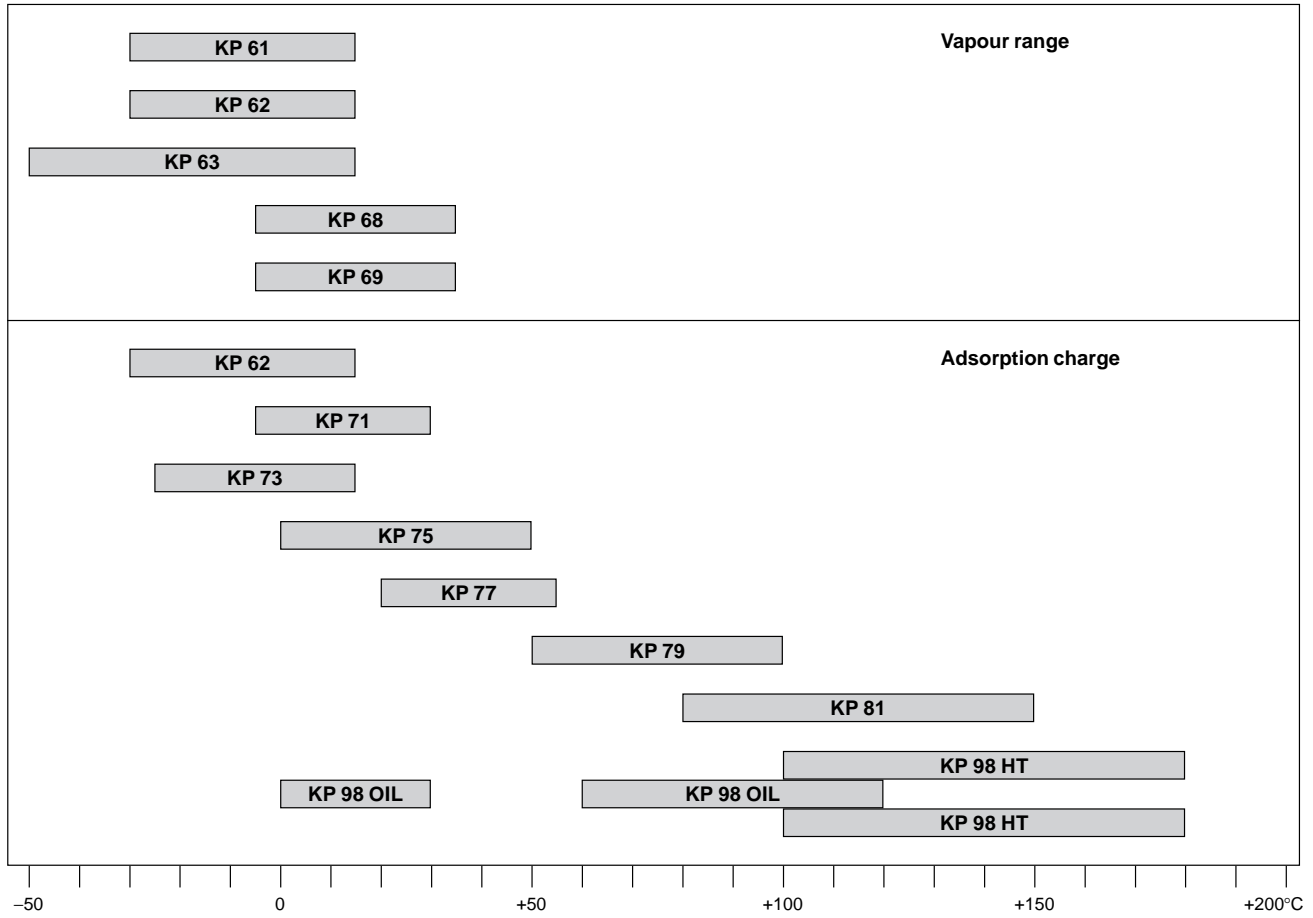

Technical data

Ambient temperature
 -40 → +65°C (+80°C for max. 2 hours).

Switch
 Single pole changeover switch (SPDT).

Contact load
 Alternating current:
 AC1: 16 A, 400 V
 AC3: 16 A, 400 V
 AC15: 10 A, 400 V
 Max. starting current (L.R.): 112 A, 400 V
 Direct current:
 DC13: 12 W, 220V control current

Cable connection
 Cable entry for cables 6 → 14 mm dia.
 A Pg 13.5 screwed cable entry can be used for 6 → 14 mm dia. cables.
 With 8 → 16 mm cables a standard Pg 16 screwed cable entry can be used.

Enclosure
 IP 33 to IEC 529
 This grade of enclosure is obtained when the unit is mounted on a flat surface or bracket.
 The bracket must be fixed so that all unused holes are covered.
 IP 44 for single and dual versions with separate top cover (accessories, must be ordered separately, see KP pressure controls).

Contact systems

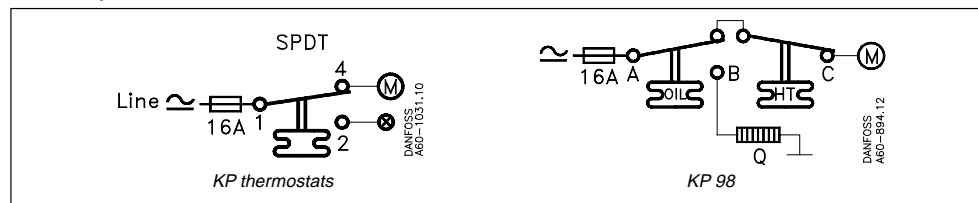

Thermostats, type KP

Ordering

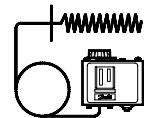
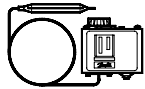

Charge	Type	Bulb type	Setting range °C	Differential at		Reset	Max. bulb temp. °C	Capillary-tube length m	Code no.
				Lowest temperature °C	Highest temperature °C				
Vapour ¹⁾	KP 61	A	-30 → 15	5.5 → 23	1.5 → 7	Aut.	120	2	60L1100
	KP 61	A	-30 → 15	5.5 → 23	1.5 → 7	Aut.	120	5	60L1101
	KP 61	B	-30 → 13	4.5 → 23	1.2 → 7	Aut.	120	2	60L1102
	KP 61	B	-30 → 15	5.5 → 23	1.5 → 7	Aut.	120	2	60L1103³⁾
	KP 61	B	-30 → 15	5.5 → 23	1.5 → 7	Aut.	120	2	60L1128³⁾ 4)
	KP 61	A	-30 → 15	Fixed 6	Fixed 2	Min.	120	5	60L1104
	KP 61	B	-30 → 15	Fixed 6	Fixed 2	Min.	120	2	60L1105
	KP 61	B	-30 → 13	4.5 → 23	1.2 → 7	Aut.	120	2	60L1177⁵⁾
	KP 61	B	-30 → 13	4.5 → 23	1.2 → 7	Aut.	120	3	60L1180
	KP 62	C 1	-30 → 15	6.0 → 23	1.5 → 7	Aut.	120		60L1106
	KP 63	A	-50 → -10	10.0 → 70	2.7 → 8	Aut.	120	2	60L1107
	KP 63	B	-50 → -10	10.0 → 70	2.7 → 8	Aut.	120	2	60L1108
	KP 68	C 1	-5 → 35	4.5 → 25	1.8 → 7	Aut.	120		60L1111
	KP 69	B	-5 → 35	4.5 → 25	1.8 → 7	Aut.	120	2	60L1112
KP 69	B	-5 → 35	4.5 → 25	1.8 → 7	Aut.	120	5	60L1165	
Adsorption ²⁾	KP 62	C 2	-30 → 15	5.0 → 20	2.0 → 8	Aut.	80		60L1110³⁾ 4)
	KP 62	C 2	-30 → 15	5.0 → 20	2.0 → 8	Aut.	80		60L1178³⁾ 5)
	KP 71	E 2	-5 → 20	3.0 → 10	2.2 → 9	Aut.	80	2	60L1113
	KP 71	E 2	-5 → 20	Fixed 3	Fixed 3	Min.	80	2	60L1115
	KP 73	E 1	-25 → 15	12.0 → 70	8.0 → 25	Aut.	80	2	60L1117
	KP 73	D 1	-25 → 15	4.0 → 10	3.5 → 9	Aut.	80	2	60L1118³⁾
	KP 73	E 2	-25 → 15	3.5 → 10	3.0 → 9	Aut.	80	5	60L1130
	KP 73	D 1	-25 → 15	Fixed 3.5	Fixed 3.5	Min.	80	2	60L1138
	KP 73	E 1	-25 → 15	12.0 → 70	8.0 → 25	Aut.	80	5	60L1139
	KP 73	D 2	-20 → 15	4.0 → 15	2.0 → 13	Aut.	55	3	60L1140
	KP 73	D 1	-30 → 10	Fixed 3.5	Fixed 3.5	Min.	80	5	60L1141
	KP 73	D 1	-30 → 15	3.5 → 20	3.25 → 18	Aut.	80	2	60L1143
	KP 75	F	0 → 35	3.5 → 16	2.5 → 12	Aut.	110	2	60L1120
	KP 75	E 2	0 → 35	3.5 → 16	2.5 → 12	Aut.	110	2	60L1137
	KP 77	E 3	20 → 60	3.5 → 10	3.5 → 10	Aut.	130	2	60L1121
	KP 77	E 3	20 → 60	3.5 → 10	3.5 → 10	Aut.	130	3	60L1122
	KP 77	E 2	20 → 60	3.5 → 10	3.5 → 10	Aut.	130	5	60L1168
	KP 77	E 3	20 → 60	3.5 → 10	3.5 → 10	Aut.	130	2	60L1189
	KP 79	E 3	50 → 100	5.0 → 15	5.0 → 15	Aut.	150	2	60L1126
	KP 81	E 3	80 → 150	7.0 → 20	7.0 → 20	Aut.	200	2	60L1125
KP 81	E 3	80 → 150	Fixed 8	Fixed 8	Max.	200	2	60L1155	
KP 98	E 2	OIL: 60 → 120	OIL: fixed 14	OIL: fixed 14	Max.	150	1	60L1131	
	E 2	HT: 100 → 180	HT: fixed 25	HT: fixed 25	Max.	250	2		
KP 98	E 2	OIL: 0 → 30	OIL: fixed 12	OIL: fixed 12	Aut.	100	1	60L1132	
	E 2	HT: 100 → 180	HT: fixed 25	HT: fixed 25	Max.	250	2		

¹⁾ Bulb must always be placed colder than the thermostat housing and capillary tube. The thermostat will then regulate independent of ambient temperature.

²⁾ Bulb can be placed warmer or colder than thermostat housing and capillary tube, but variations from +20°C ambient temperature will influence the scale accuracy.

³⁾ With manual switch, not isolating switch.





⁴⁾ Panel mounting model with top plate.

⁵⁾ Thermostats with gold-plated contacts.

Thermostats, type KP

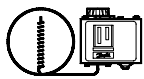
Ordering (continued)

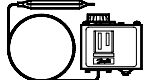
Thermostat bulb types

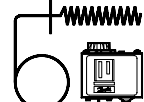
A		Straight capillary tube
B		Ø 9.5 × 70 mm remote air coil
C		C1: Ø 40 × 25 mm air coil C2: Ø 25 × 67 mm air coil (integral with thermostat)
D		D1: Ø 10 × 85 mm double contact remote bulb D2: Ø 16 × 170 mm double contact remote bulb Note! Cannot be used in sensor (bulb) pocket
E		E1: Ø 6.4 × 95 mm remote bulb E2: Ø 9.5 × 115 mm remote bulb E3: Ø 9.5 × 85 mm remote bulb
F		Ø 25 × 125 mm remote duct coil

Thermostats, type KP

Design Function

1. Temperature setting spindle
2. Differential setting spindle
3. Main arm
7. Main spring
8. Differential spring
9. Bellows
12. Switch
13. Terminals
14. Earth terminal
15. Cable entry
16. Tumbler
17. Sensor

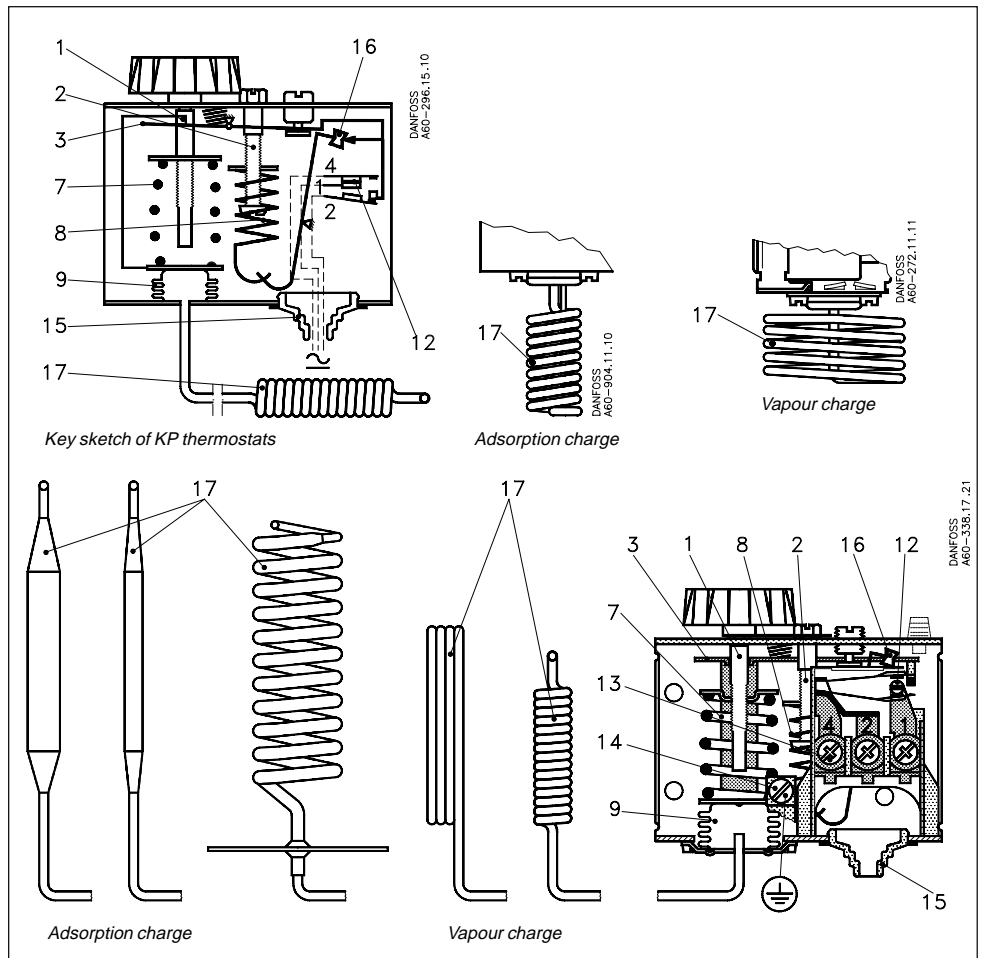

The switch in the KP has a snap-action function and the bellows move only when the cut-in or cut-out value is reached.

The design of the KP thermostat affords the following advantages:

- high contact load
- ultra-short bounce time
- vibration resistance up to 4 g in the range 0-1000 Hz
- long mechanical and electrical life.

**Design
Function**
(continued)

- 1. Temperature setting spindle, OIL
- 3. Main arm
- 5. Temperature setting spindle, HT
- 7. Main spring
- 9. Bellows
- 10. Capillary tube, OIL
- 11. Capillary tube, HT
- 12. Switch
- 13. Terminals
- 14. Earth terminal
- 15. Cable entry
- 16. Tumbler
- 17. Sensor (bulb)
- 18. Locking plate

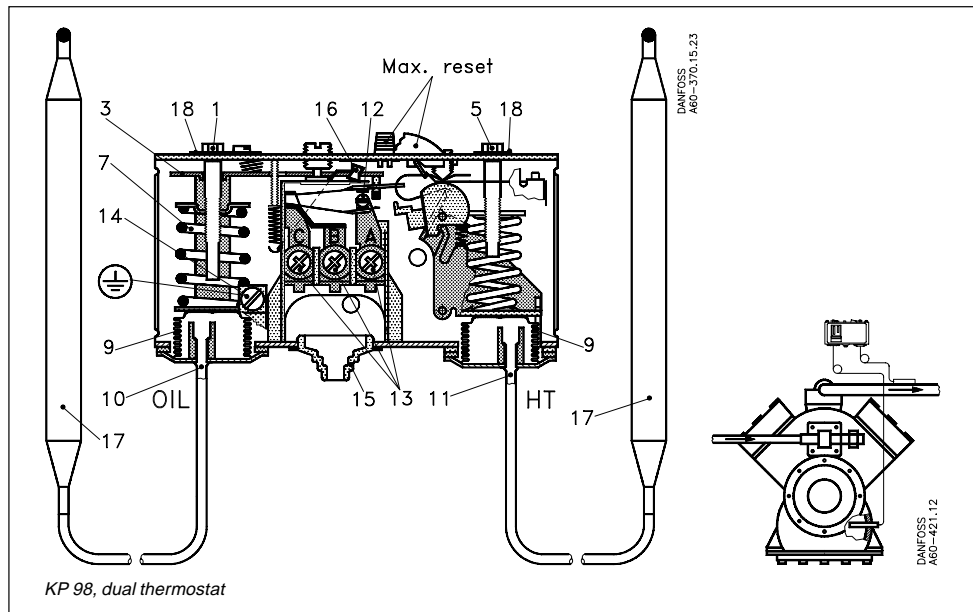

Dual thermostat KP 98 is used as a protection against too high a discharge gas temperature and to ensure a suitable oil temperature in the compressor.

To avoid the temperature of the hot gas exceeding the maximum permissible value during extreme operating conditions (low evaporating pressure, high condensing pressure, high suction vapour superheat) a KP 98 thermostat can be used on the high temperature side (HT). If the temperature of the hot gas becomes too high the refrigerant will break down and the compressor discharge valve will become damaged.

The risk is greatest in refrigeration systems that operate on a high compression ratio (e.g. in systems with NH₃ or R 22) and in applications with hot gas bypass.

This unit has two separate thermostat functions. The HT sensor that controls the discharge gas temperature is fitted on the discharge tube immediately after the compressor.

For larger compressors, the sensor can be built into the discharge tube.

The OIL sensor that controls the oil temperature is located in the compressor oil sump.

KP 98 is available in two versions:

A. Protection against low oil temperature
Compressor manufacturers recommend fitting a heating element in the crankcase to prevent refrigerant boiling out of the oil during start.

KP 98 is the correct thermostat for controlling this heating element.

Why a heating element?

During standstill, refrigerant is dissolved in the crankcase oil. If the oil is cold and the standstill period long a large amount of refrigerant can become dissolved. This leads to two problems:

1. When the compressor is started, the refrigerant will boil off. There is a high risk of liquid hammer and consequent compressor damage.
2. The oil loses its lubricating capability when it is thinned with refrigerant.

To avoid these problems a heating element controlled by a KP 98, **60L1132**, should be fitted in the crankcase to keep the oil warm. This then prevents dangerous amounts of refrigerant being dissolved in the oil.

B. Protection against high oil temperature

Compressor manufacturers recommend that compressors used in connection with industrial heat pumps or refrigerating systems be equipped with a thermostat to give protection against too high an oil temperature in the crankcase.

In periods of peak load, too high an oil temperature leads to insufficient lubrication of the compressor, with the risk of compressor damage. KP 98, **60L1131**, monitors the oil temperature so that it cannot become too high.

Terminology

Differential

The differential is the difference between the make and break temperatures. A differential is necessary for satisfactory automatic operation of the plant.

Mechanical differential (intrinsic differential)

The mechanical differential is the differential set by the differential spindle.

Operating differential (thermal differential)

The operating differential is the differential the plant operates on. Operating differential is the sum of the mechanical differential and the differential produced by the time constant.

Reset

1. Manual reset:

Units with manual reset can only be restarted after the reset button has been activated. On min. reset units the set value is equal to the cut-out value for falling temperature. On max. reset units the set value is equal to the cut-out value for rising temperature.

2. Automatic reset:

These units are automatically reset after operational stop.

Thermostats, type KP

Setting

Thermostats with automatic reset

Set the upper activating temperature on the range scale.

Set the differential on the "DIFF" scale.

The temperature setting on the range scale will then correspond to the temperature at which the refrigeration compressor will be started on rising temperature. The compressor will be stopped when the temperature has fallen in relation to the differential setting.

Please note that the differential depends on the range setting. Therefore, the differential scale must only be used as guideline.

If with low stop temperature settings the compressor will not stop, check whether the differential is set at too high a value!

Thermostats with minimum reset

Set the stop temperature on the range scale. The differential is a fixed setting.

The compressor can be restarted by pressing the "Reset button" after the temperature on the thermostat sensor has risen by a value equal to the fixed differential setting.

Thermostats with maximum reset

Set the stop temperature on the range scale. The differential is a fixed setting.

The compressor can be restarted by pressing the "Reset button" after the temperature on the thermostat sensor has fallen to a value equal to the fixed differential setting.

Charges

1. Vapour charge

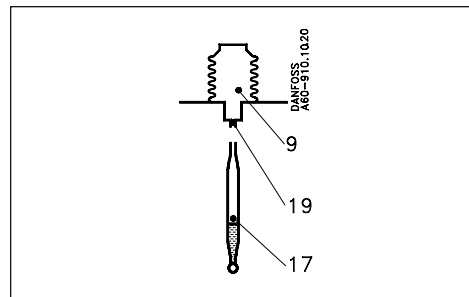

- 9. Bellows element
- 17. Sensor (bulb)
- 19. Capillary tube

Here the interdependence between the pressure and temperature of saturated vapour is utilized, i.e. the element is charged with saturated vapour plus a small amount of liquid.

The charge is pressure-limited; a further increase in pressure after evaporation of all the liquid in the sensor (17) will only result in a small pressure increase in the element.

This principle can be utilized in thermostats for low temperature, etc. where evaporation must be able to take place from the free liquid surface in the sensor (within the operating range of the thermostat), and where at the same time, the bellows must be protected against deformation when kept at normal ambient temperatures. Since the pressure in the element depends on the temperature at the free liquid surface, the thermostat must always be placed so that the sensor is colder than the rest of the thermostatic element.

The evaporated liquid will recondense at the coldest point, i.e. the sensor. Thus, as intended, the sensor becomes the temperature-controlling part of the system.

Note: When the sensor is coldest, the ambient temperature has no effect on regulating accuracy.

2. Adsorption charge

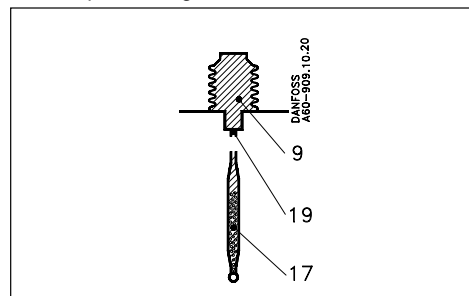

- 9. Bellows element
- 17. Sensor (bulb)
- 19. Capillary tube

In this case the charge consists partly of a superheated gas and partly of a solid having a large adsorption surface.

The solid is concentrated in the sensor (17) and it is therefore always the sensor that is the temperature-controlling part of the thermostatic element.

The sensor can be placed warmer or colder than thermostat housing and capillary tube, but variations from +20°C ambient temperature will influence the scale accuracy.

Dimensions and weights

