



Electronic controller

EKC 201 and EKC 301

Introduction



EKC 201 (for panel mounting) and EKC 301 (for DIN-rail mounting) have been specially developed for control duties in refrigeration plant so that operation, setting and programming are optimised and simplified as much as possible.

All controllers are designed for room temperature control via pump down or compressor start/stop and have been grouped into four main applications dependent on the type of defrost and its control. See "*Controller application overview*".

EKC 201 and 301 are used for

- *temperature control*
- *compressor control*
- *fan motor control*
- *defrost control*
- *alarm signalling*

With only two keys, all functions can be set and programmed.

The display shows the actual room temperature, but by activating the keys the display changes to the set or the actual temperature of the defrost sensor.

Fitting the EKC controller with a plug-in module for communication via a standard data bus (Echelon) gives access to all parameters of the controller.

The digital input can be programmed to

- receive alarm signals from an external signal source (door alarm)
- start defrost from an external clock
- transmit random alarm signals to the bus system.

Features

- One electronic controller is able to replace several traditional controllers and defrost clocks.
- Can be supplied for panel as well as DIN-rail mounting.
- Temperatures, times, operating conditions, parameter codes and alarm and fault codes can be read from the display.
- Three LEDs indicate the actual condition of the system:
 - refrigeration
 - defrost
 - fan running.
- Easy to re-establish factory setting.
- In the event of error function, the actual parameter code can be displayed.
- All alarms are indicated by the three LEDs flashing at once.
- Danfoss Pt 1000 sensors are supplied with the controller:
 - calibration of sensor circuit not necessary
 - controller-sensor system can be used direct for data logging.
- Facility for bus communication with SCADA systems
- Real time clock (battery driven) can be fitted.

Controller application overview

Function	Application no.			
	1	2	3	4
Room temperature control by pump down or compressor start/stop				
Natural defrost				
Temperature-controlled defrost with electricity or hot gas				
Time-controlled defrost with electricity or hot gas				
Fan motor control				

Controller for application number 3 satisfies requirement for

- 1) room temperature control (thermostat) by pump down or compressor start/stop
- 2) time controlled defrost using hot gas or electricity
- 3) fan motor control.

Application no. 1

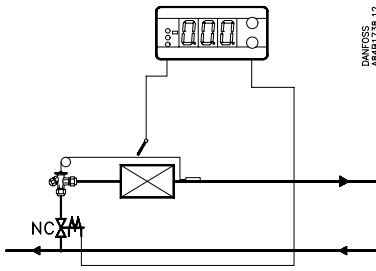

Room temperature control by pump down.
Natural defrost on pump down.

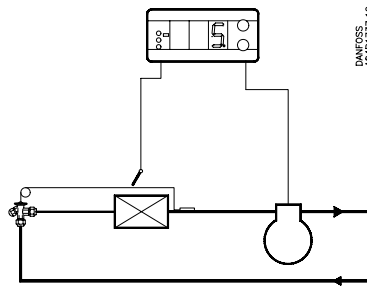

Room temperature control by compressor start/stop.
Natural defrost on compressor stop.

Application no. 2

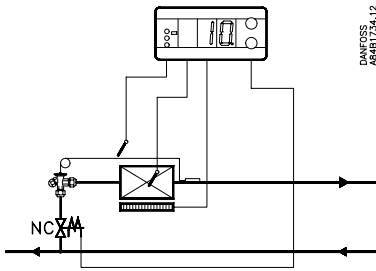

Room temperature control by pump down.
Temperature-controlled electric defrost.

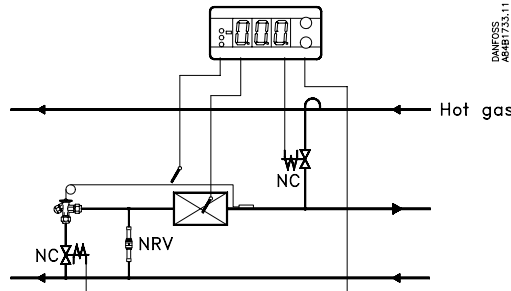

Room temperature control by pump down.
Temperature-controlled hot gas defrost.

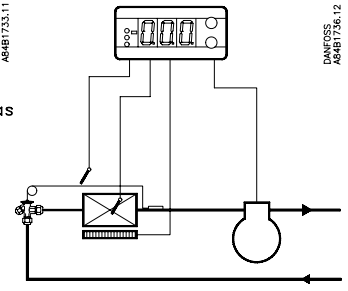

Room temperature control by compressor start/stop.
Temperature-controlled electric defrost.

Application no. 3

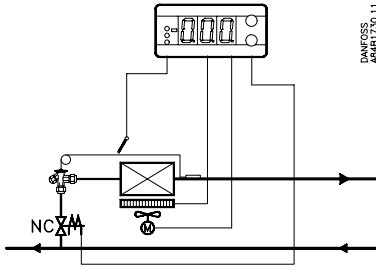

Room temperature control by pump down.
Time-controlled electric defrost.

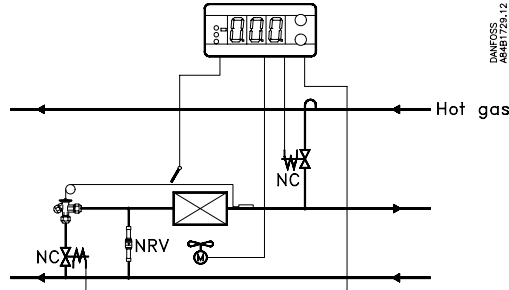

Room temperature control by pump down.
Time-controlled hot gas defrost.

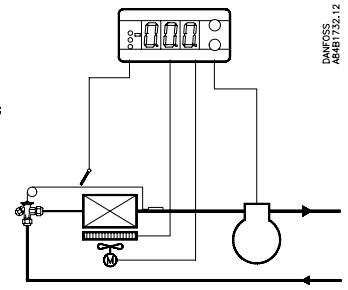

Room temperature control by compressor start/stop.
Time-controlled electric defrost.

Application no. 4

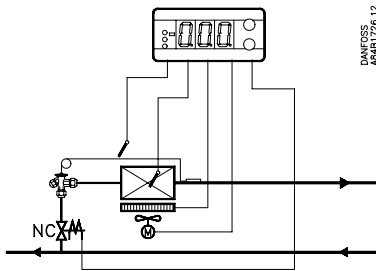

Room temperature control by pump down.
Temperature-controlled electric defrost.

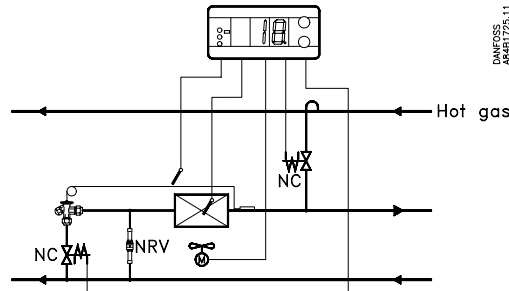

Room temperature control by pump down.
Temperature-controlled hot gas defrost.

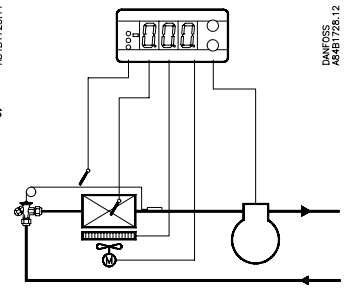

Room temperature control by compressor start/stop.
Temperature-controlled electric defrost.

Technical data

Supply voltage

Panel version	12 V a.c./d.c. +15/-15 % 230 V a.c. +10/-15 % (certain versions)
DIN version	230 V a.c. +10/-15 %

Power consumption

Panel version	2.5 VA
DIN-rail version	5.0 VA

Transformer

12 V controllers must be connected to separate transformer of min. 3 VA

Sensors

Type	Pt 1000 PTC (R ₂₅ = 1000 ohm)
------	---

Controller-sensor system

Measuring range	-60 → +50°C
Accuracy	±0.5°C for sensor temperature -35 → +25°C; ±1°C for sensor temperature -60 → -35°C and +25 → +50°C

Display

LED, three digits
0.1°C read-off accuracy in measuring range

External alarm contact

Standard SPST contact (door alarm)

Electrical connection cable

Panel version	1.5 mm ² multi-core cable
DIN version	2.5 mm ² multi-core cable

Relays

Controller relay	SPST NO, I _{max} = 6 A ohmic/3 A AC 15* inductive
Defrost relay	SPST NO, I _{max} = 6 A ohmic/3 A AC 15* inductive
Fan motor relay	SPDT NO, I _{max} = 6 A ohmic/3 A AC 15* inductive
Alarm relay	SPST NC, I _{max} = 4 A ohmic/1 A AC 15* inductive I _{min} = 1 mA on 100 mV**

* AC 15 load to EN 60947-5-1

** Gold plating ensures make function with small contact loads

Ambient temperature

Operation	0 → +55 °C
Transport	-40 → +70 °C

Enclosure

Panel version	IP 54
DIN version	IP 20

Approvals

EU low-voltage directive and EMC stipulations on CE marking are complied with. LVD-tested to EN 60730-1 and EN 60730-2-9. EMC-tested to EN 50081-1 and EN 50082-1

Ordering

EKC 201, Controllers for panel mounting

Application no.	Code no. (Controller + Pt 1000 ohm sensor(s))			
	12 V a.c./d.c.		230 V a.c.	
	Without alarm relay	With alarm relay	Without alarm relay	With alarm relay
1	084B7025	084B7028	084B7031	084B7032
2	084B7026	084B7029		
3	084B7027	084B7030		
4	084B7027	084B7030		

EKC 301, Controllers for DIN-rail mounting

	Code no. (controller + Pt 1000 ohm sensor(s))	
	230 V a.c.	
	Without alarm relay	With alarm relay
	084B7033	084B7036
	084B7034	084B7037
	084B7035	084B7038
	084B7035	084B7038

Accessories

Plug-in modules

Description	Code no.	
	EKC 201	EKC 301
Real time clock	084B7070	084B7071
Bus communication card FTT	084B7072	084B7073
Bus communication card RS 485	084B7074	084B7075

Transformer, 230/12 V

Code no.. 084B7090 (one per controller)

Dimensions and weights

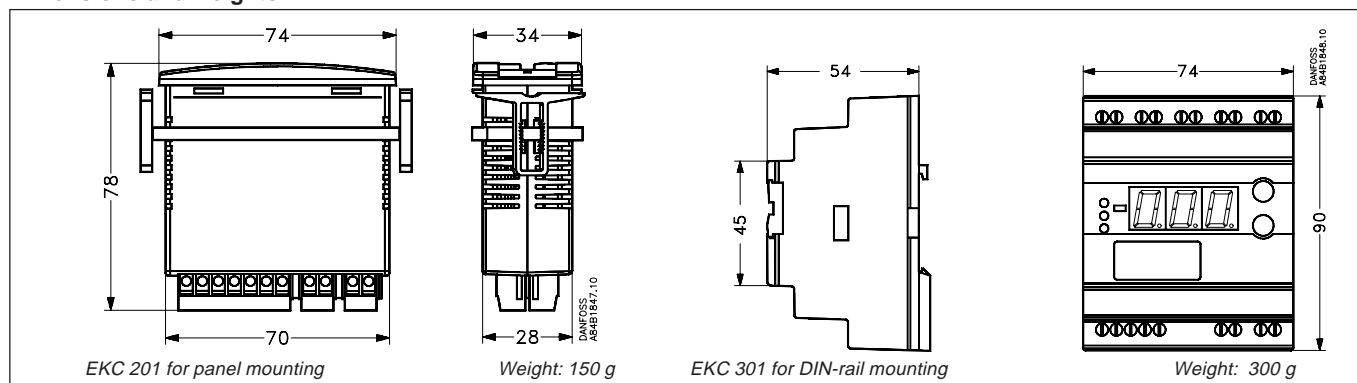

Controller application setting parameters

Setting and read-off parameters	Parameter codes	Controller application no.				Min. value	Max. value	Factory setting	Actual setting
		1	2	3	4				
Temperature controller, Temperature						-60°C	50°C	3°C	
Thermostat									
Differential ¹⁾	r01					0.1 K	20 K	2 K	
Max. limitation of set temperature	r02					-59°C	50°C	50°C	
Min. limitation of set temperature	r03					-60°C	49°C	-60°C	
Adjustment of temperature indication	r04					20 K	20 K	0.0 K	
Temperature unit (°C/°F)	r05							°C	
Alarm									
Upper deviation (above temp. setting + differential ²⁾)	A01					0 K	50 K	10 K	
Lower deviation (below temp. setting ²⁾)	A02					50 K	0 K	10 K	
Temperature alarm delay	A03					0 min	90 min	30 min	
Door alarm delay	A04					0 min	90 min	60 min	
Compressor									
Min. ON-time	c01					0 min	15 min	0 min	
Min. OFF-time	c02					0 min	15 min	0 min	
Cut-in frequency on sensor fault ³⁾	c03					0 %	100 %	0 %	
Compressor stop at open door (yes/no)	c04							no	
Defrost									
Defrost method (EL/GAS)	d01							EL	
Defrost stop temperature	d02					0°C	25°C	6°C	
Interval between defrost starts	d03					OFF	48 hour	8 hour	
Max. defrost duration	d04					0 min	180 min	45 min	
Defrost time delay (after power up)	d05					0 min	60 min	0 min	
Drip-off time	d06					0 min	20 min	0 min	
Fan start delay after defrost	d07					0 min	20 min	1 min	
Fan start temperature	d08					-15°C	0°C	-5°C	
Fan cut-in during defrost (yes/no)	d09							no	
Defrost sensor (yes/no)	d10							yes	
Temperature alarm delay after defrost	d11					0 min	199 min	90 min	
Delay of display view after defrost stop	d12					0 min	15 min	1 min	
Fan									
Fan stop on compressor cut-out (yes/no)	F01							no	
Fan stop delay	F02					0 min	30 min	0 min	
Fan stop at open door (yes/no)	F03							yes	
Miscellaneous									
Delay of output signal after start-up	o01					0 s	600 s	5 s	
Digital input signals ⁴⁾ (0 = not used, 1 = door alarm, 2 = defrost, 3 = bus)	o02							0	
Access code	o05					OFF	100	OFF	
Used sensor type (Pt / PTC)	o06							Pt	
Real time clock (if fitted)									
Six start times for defrost All can be cut out by setting on OFF	t01 → t06					0	23	OFF	
Hour setting	t07					0 hour	23 hour	0 hour	
Minute setting	t08					0 min	59 min	0 min	

Fault code display		Alarm code display		Status code display	
E 1	Fault in controller	A 1	High temperature alarm	S 2	ON-time
E 2	Disconnected room sensor	A 2	Low temperature alarm	S 3	OFF-time
E 3	Short-circuited room sensor	A 4	Door alarm	S 4	Drip-off time
E 4	Disconnected defrost sensor				
E 5	Short-circuited defrost sensor				
E 6	Change battery				

¹⁾ The compressor relay closes when the room temperature exceeds the setting value and differential.

²⁾ Alarm is released and sensor failure is indicated, if the room temperature reaches 5°C or more outside the setting range -60° to +50°C.

³⁾ The frequency is measured after approx. three days and nights operation after start of the plant (72 cyclings) otherwise:
ON-time = c03 × 20: 100 minutes
OFF-time interval 20 minus ON-time per minute

⁴⁾ Function possibilities with SPST contact, connected to the terminals 3 and 4 are the following:

Door alarm: If SPST is cut out, alarm signalling starts and the fan is stopped, cf. A04 or F02.

Defrost: If SPST is cut in, defrost starts. (However, if d03 is not OFF, defrost will during contact break down start with the programmed time intervals).

Bus: With installed communication card, the position of the SPST contacts will be registered in the BUS system.

Electrical connection

Application 1
without alarm relay

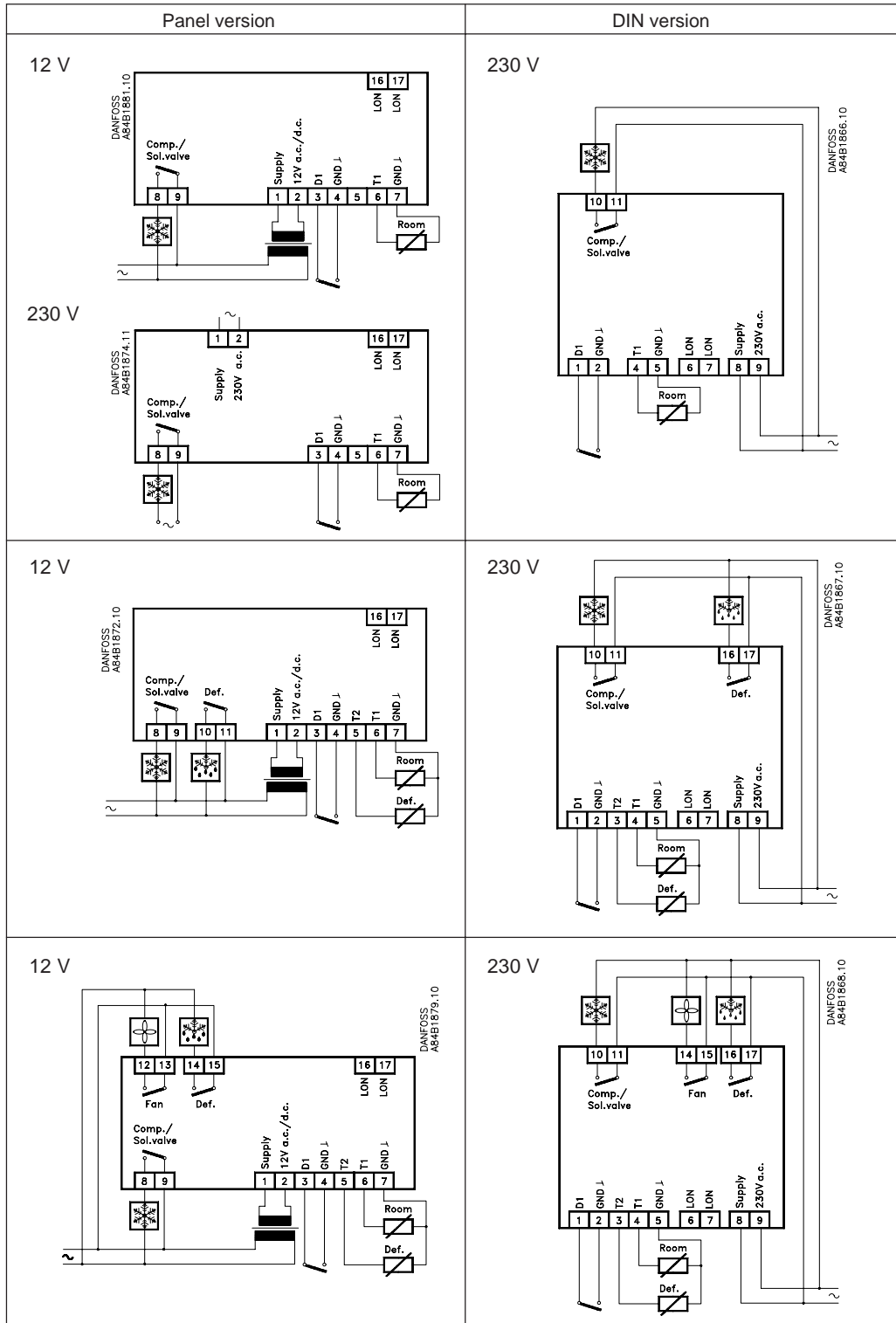

Application 1
with alarm relay

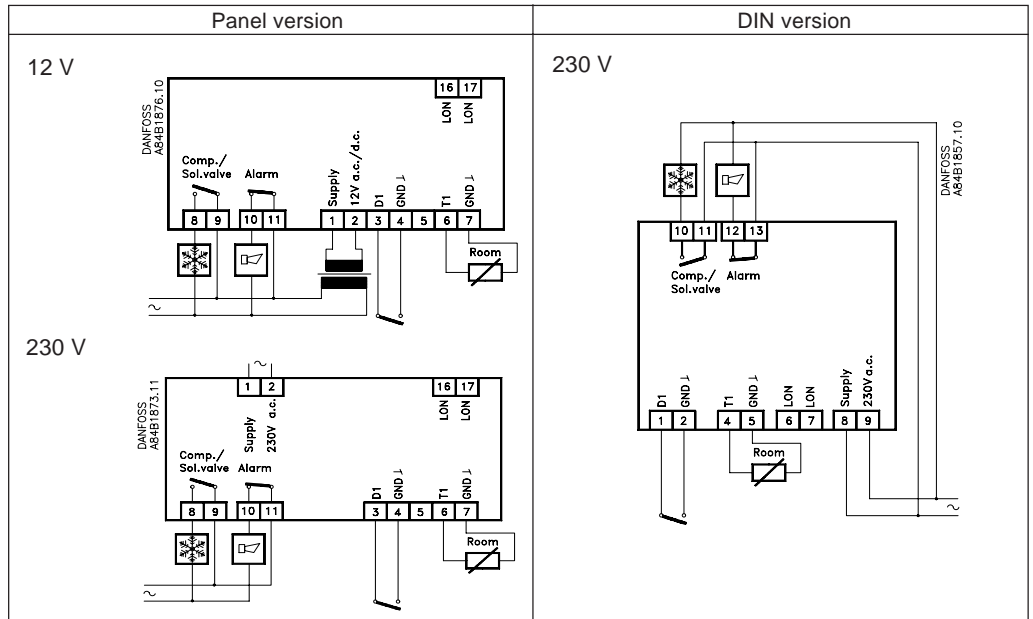

Application 2
with alarm relay

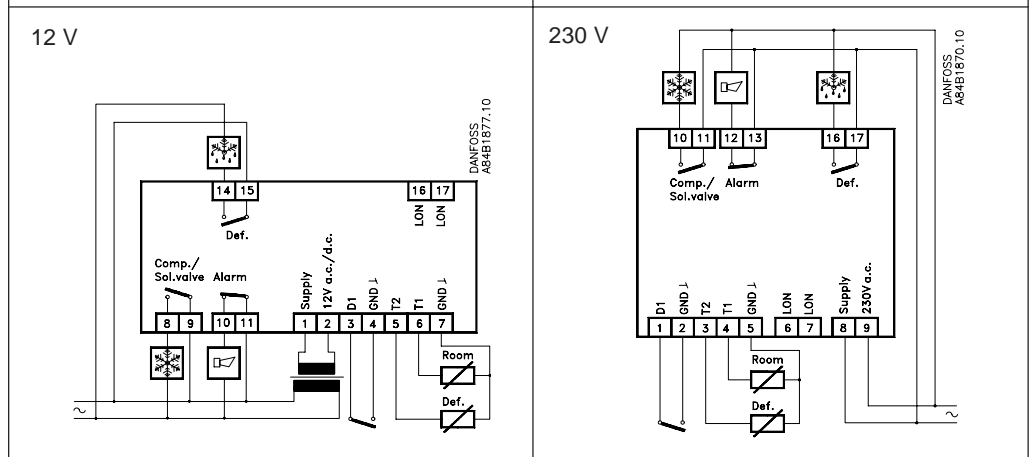

Application 3 and 4
with alarm relay

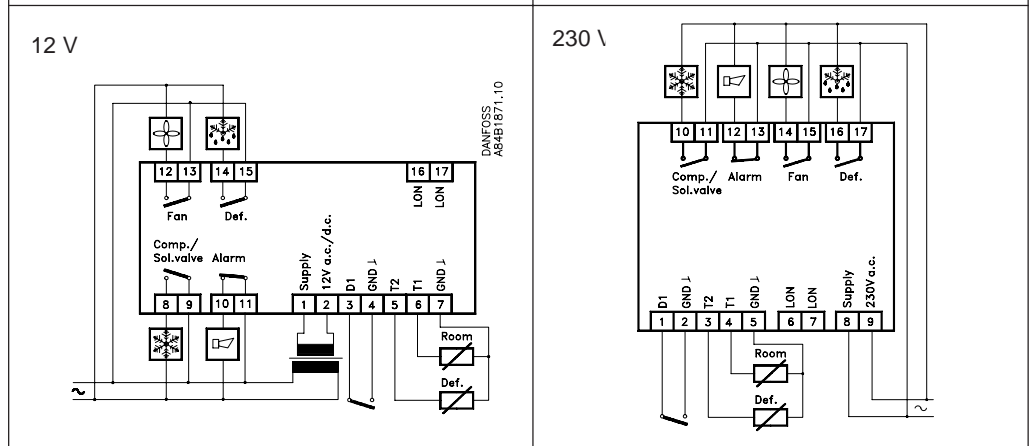

Danfoss can accept no responsibility for possible errors in catalogues, brochures and other printed material.
Danfoss reserves the right to alter its products without notice. This also applies to products already on order provided that such alternations can be made without subsequential changes being necessary in specifications already agreed.
