

# INSTRUCTIONS

060R9748

060R9748

## Pressure Controls KP 61 → 81

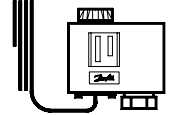

KP 61, 62, 63, 68, 69 vapor charge  
KP 71, 73, 75, 77, 79, 81 adsorption charge (cross ambient)

### Types

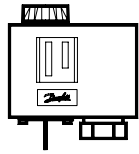

Auto reset

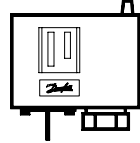

Manual reset  
(w/o hand knob)

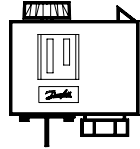

Auto reset  
w/ hand switch

### Bulb types

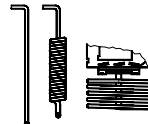

Vapor charge

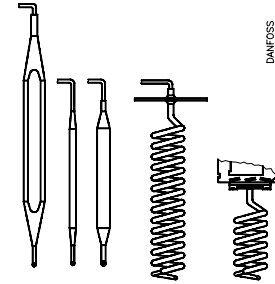

Adsorption charge

DANFOSS  
A60-355.13

### Mounting requirement

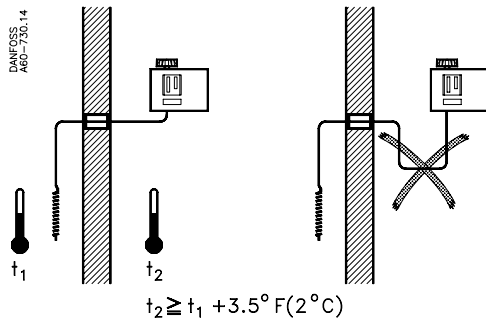

Vapor charge

### Max. bulb temperature

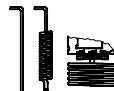

Vapor charge

KP 61, 62, 63 Max.  
68, 69 :250°F (120°C)

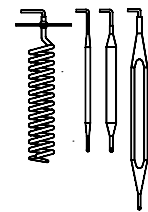

Adsorption charge

Max.  
KP 71, 73:175°F (80°C)  
KP 75 :230°F (110°C)  
KP 77 :270°F (140°C)  
KP 79 :300°F (150°C)  
KP 81 :390°F (200°C)

DANFOSS  
A60-732.11

### Ambient temperatures

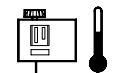

DANFOSS  
A60-732.11

min. -40°F (-40°C)  
max. 150°F (65°C)

### Enclosure

DANFOSS  
A60-735.11

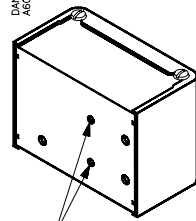

10-32 UNC

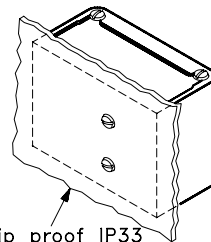

Drip proof IP33  
(IEC 529)

max. 1/8 in  
(3mm)

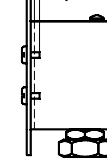

CAUTION: The mounting panel must be plane to avoid damage of control.

### Cable entry

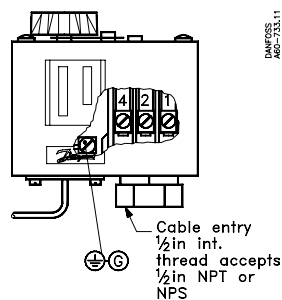

DANFOSS  
A60-733.11

### Required cap. tube length on evaporator

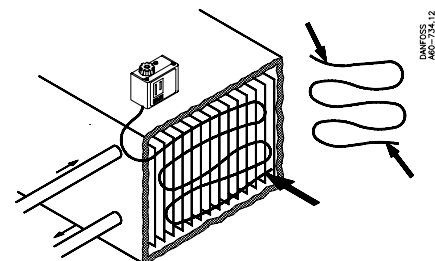

DANFOSS  
A60-354.12

80 in. cap. tube: min. 16 in.  
196 in. cap. tube: min. 22 in.

## Wiring

CAUTION: Disconnect power supply before wiring connections are made to avoid possible electrical shock or damage to equipment.

All wiring should conform to the National Electrical Code and local regulations.

Terminal block

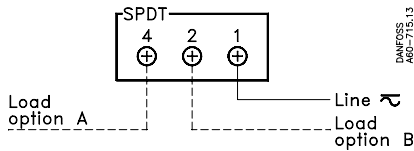

CAUTION: Use terminal screws furnished in the contact block.

Use tightening torque 20 lb. in. (2.3 Nm).

Use copper wire only.

Contact load ratings

120 V a.c.	16 FLA, 96 LRA
240 V a.c.	8 FLA, 48 LRA
240 V .c.	12 W pilot duty

## Load Option A

CUT-OUT on temperature drop

Wire terminals 1-4:

CUT-IN = High Set Point (HSP)  
see "Setting"

CUT-OUT = Low Set Point (LSP)  
see "Setting"

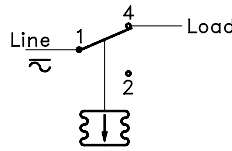

Terms 1-4 close on temperature rise  
Terms 1-4 open on temperature drop

Example: CUT-IN = +50°F (+10°C)  
CUT-OUT = +40°C (+4.5°C)

This means  
CUT-IN = HSP = +50°F (+10°C)  
and  
CUT-OUT = LSP = +40°F (+4.5°C)

Note:  
↑ = Bellows movement on pressure rise  
↓ = Bellows movement on pressure drop  
The free terminal can be used for signal purpose.

## Load Option B

CUT-OUT on temperature rise

Wire terminals 1-2:

CUT-IN = Low Set Point (LSP)  
see "Setting"

CUT-OUT = High Set Point (HSP)  
see "Setting"

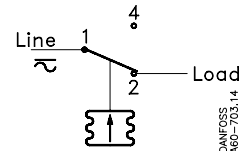

Terms 1-2 close on temperature drop  
Terms 1-2 open on temperature rise

Example: CUT-IN = +32°F (+0°C)  
CUT-OUT = +50°F (+10°C)

This means  
CUT-IN = LSP = +32°F (+0°C)  
and  
CUT-OUT = HSP = +50°F (+10°C)

## Manual tripping

(Electrical contacts/wiring test)

Note:  
use FINGERS ONLY!  
(Do NOT use screwdriver)

Up  
Down  
Main lever  
KP w/ auto reset

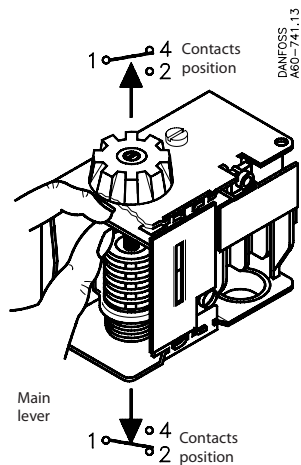

Note:  
use FINGERS ONLY!  
(Do NOT use screwdriver)

Up  
Down  
Main lever  
KP w/ manual reset

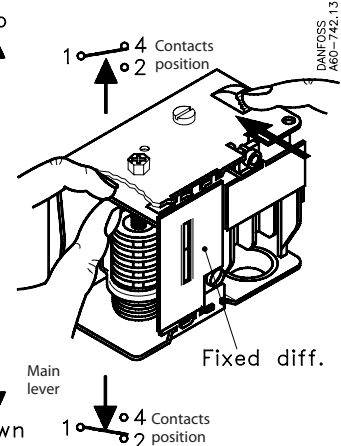

Note:  
Push manual reset knob during manual tripping.

## Manual reset

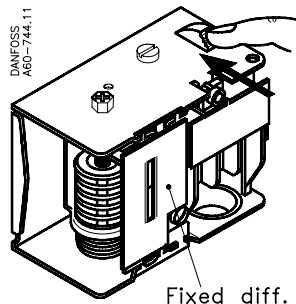

To resume control operation after safety cut-out, push reset knob as indicated.

Note:  
Man. reset is possible only after a temperature rise of fixed differential (example 5.4°F)

## Adjustment spindles location

### Note!

Remove lockplate before thermostat adjustment. Replace lockplate after adjustment (if desired).

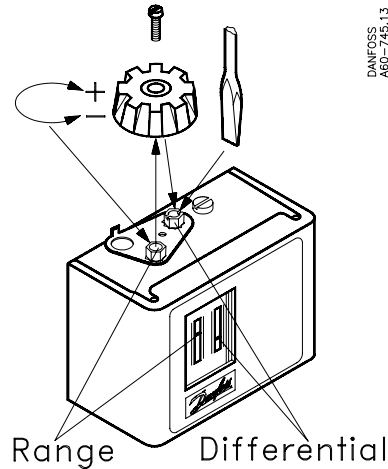

### RANGE

See printed instruction on top of control



increase temp. (warmer): turn CW



decrease temp. (colder): turn CCW

(use adjustment knob)

### DIFFERENTIAL

See printed instruction on top of control



Increase: turn CW



decrease: turn CCW

(use adjustment knob or screwdriver)

## Determination of differential

For KP w/ vapor charge and auto. reset (KP 61, KP 62, KP 63, KP 68, KP 69): Use graphs to determine correct differential

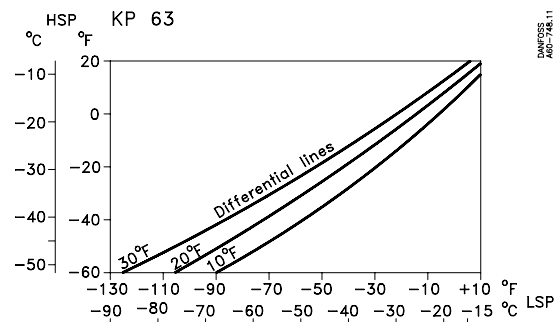
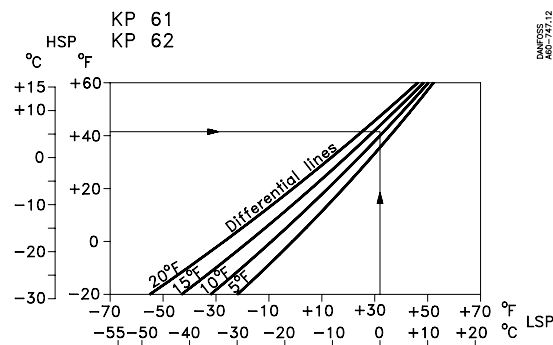

### Example:

HSP = +45°F (+5.6°C)    =>    DIFF (from graph):  
 LSP = +32°F (0°C)            13°F (7.2°C) (value which has to be  
    set on diff. scale).

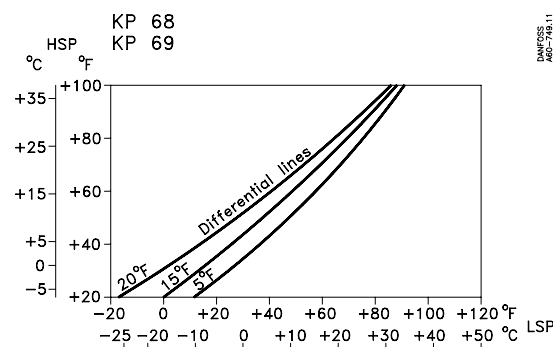

For KP w/ adsorption charge (KP 71, KP 73, KP 75, KP 77, KP 79, KP 81):  
 The differential will be HSP less LSP

Example:            HSP - LSP = DIFF.  
                          45°F - 35°F = 10°F  
                          (7°C)    (5°C)    (2°C)

### Note:

(Load Option A)            (Load Option B)  
 CUT-IN = HSP    or    CUT-IN = LSP  
 CUT-OUT = LSP    CUT-OUT = HSP  
 See "Wiring"

## Setting

For KP 61, 62, 63, 68, 69, 71, 73, 75, 77, 79 and 81 w/ AUTO RESET

1. Adjust range spindle to desired HIGH SET POINT (use hand knob)
2. Adjust differential spindle to desired DIFFERENTIAL

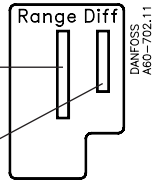

KP 61 and KP 71 w/ MAN. RESET

1. Adjust range spindle to desired LOW SET POINT
2. DIFFERENTIAL is fixed. Value printed on scale plate

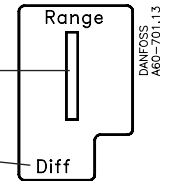

Note:

To find correct differential, see "Determination of differential"

HIGH SET POINT minus DIFFERENTIAL equals LOW SET POINT

Example:

$$\begin{array}{rclcl} \text{HSP} & - & \text{DIFF.} & = & \text{LSP} \\ 45^{\circ}\text{F} & - & 10^{\circ}\text{F} & = & 35^{\circ}\text{F} \\ (7^{\circ}\text{C}) & & (5^{\circ}\text{C}) & & (2^{\circ}\text{C}) \end{array}$$

HIGH SET POINT minus DIFFERENTIAL equals LOW SET POINT

Example:

$$\begin{array}{rclcl} \text{HSP} & - & \text{DIFF.} & = & \text{LSP} \\ 37.4^{\circ}\text{F} & - & 5.4^{\circ}\text{F} & = & 32^{\circ}\text{F} \\ (3^{\circ}\text{C}) & & (3^{\circ}\text{C}) & & (0^{\circ}\text{C}) \end{array}$$

## KP w/ hand switch

CAUTION:

- Hand switch breaks circuit by micro contact gap.
- Use hand switch for service on refrigeration parts only
- Cut out main switch before service on electrical parts

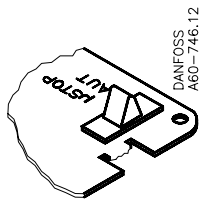

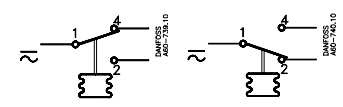
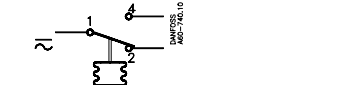
Switch position	Contacts position
Aut.	Automatic control operation 
μ Stop	1 and 2 are closed 

KP 61	060L2003	Vapor charge
KP 73	060L2014	Adsorption charge