

Televes®

COAXDATA

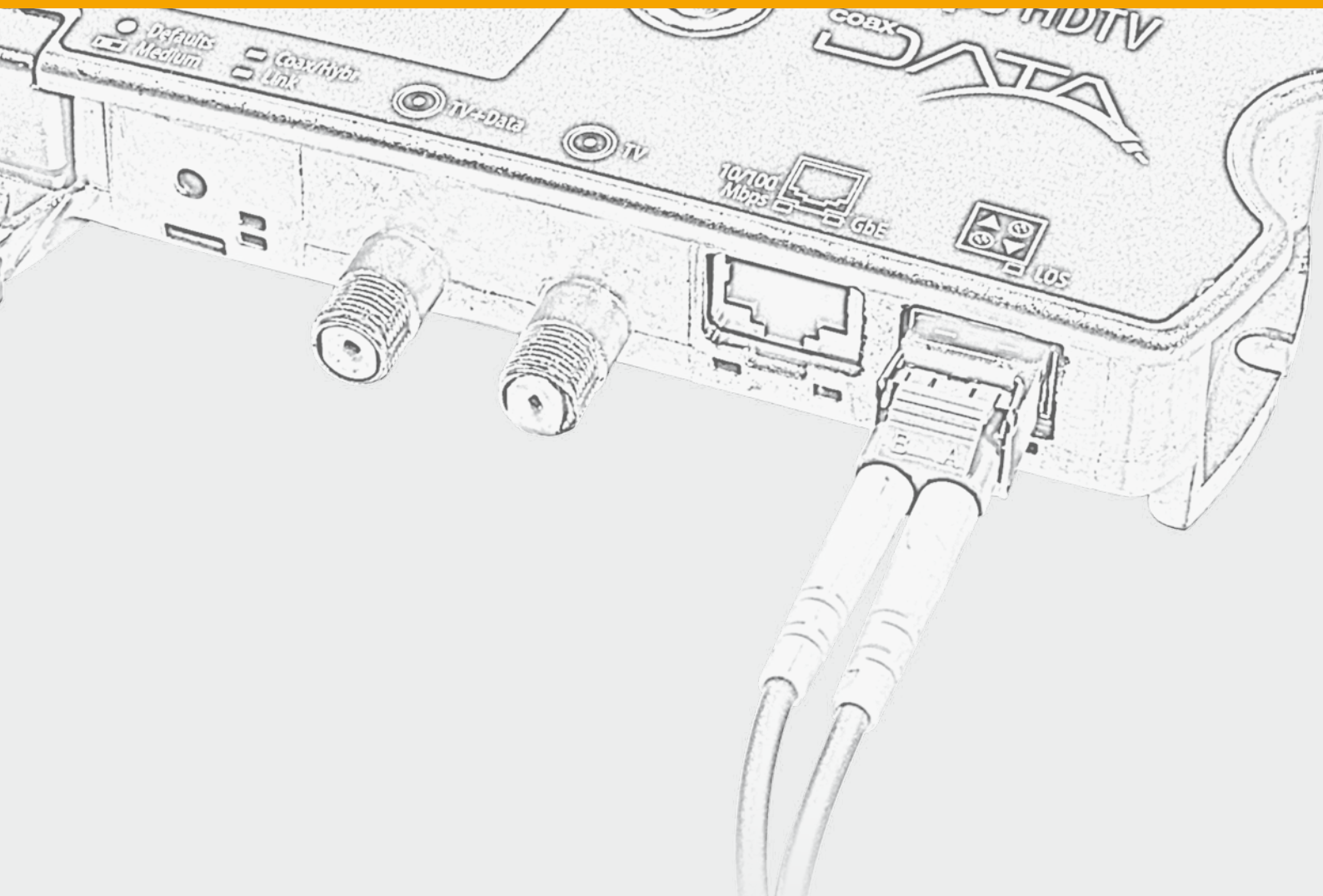

ETHERNET COAXIAL ADAPTER

Coaxdata: HomePlug AV and Gigabit (HomePlug AV IEEE1901)



The bandwidth of the coaxial cable allows to multiplex a number of services other than television.

Coaxdata is a state-of-art system that converts a television coaxial network into a high speed local network. By means of Coaxdata, sharing resources (computers, printers, an internet connection, etc) does not need any additional cable.

This system allows its integration in coaxial networks and the data electric power distribution (PLC) and includes features which allows its deployment in optical fiber networks.

- ▶ **High throughput** for applications such as VoIP, video streaming, video on demand, internet access, etc.
- ▶ **Integrated QoS (Quality of Service). 128bit AES Encryption.**
- ▶ **Flexible and upgradable solution** for the construction of segments of **up to 253 devices**.
- ▶ **No changes are necessary in the topology of the coaxial network** to coexist with existing TV services. Coaxial cable high attenuations (~85dB) are supported.
- ▶ **Remote management is possible** by means of the **CoaxManager Software and Control Access Software**.

200 Mbps



▲ 7689



▲ 768973

1 Gbps



▲ 769201



▲ 769203



▲ 769202

REF.	DESCRIPTION
Coaxdata Homeplug 200Mbps units	
7689	CoaxData 200 Mbps coaxial + PLC, 2 ETH connectors
768973	CoaxData 200 Mbps coaxial, 1 ETH connector
Coaxdata Gigabit 1 Gbps units	
769201	CoaxData 1Gbps-HDTV coaxial + PLC, 2 ETH connectors
769203	CoaxData 1Gbps-HDTV coaxial, 1 ETH connector
769202	CoaxData 1Gbps-HDTV coaxial + PLC, 1 ETH connector and 1 SFP connector

ETHERNET COAXIAL ADAPTER

Type of installation

► Home Networking

Local network between users.

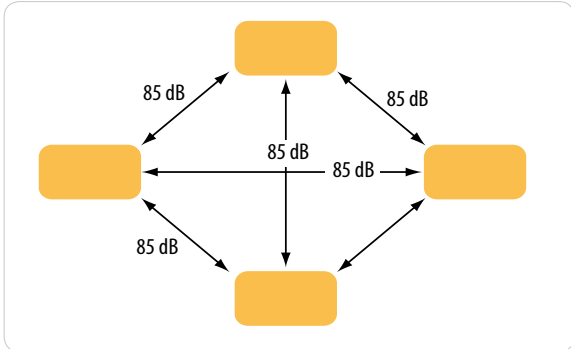

Multipoint-to-Multipoint

Local network with connection between all the devices.

► MDU/MTU (MXU)

Shared access to internet.

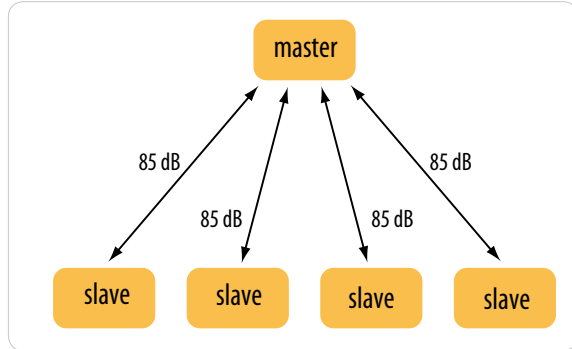

Point-to-Multipoint

Local network with no communication between slaves.

TV - Data diplexer filters



QR-A00100

REF.	DESCRIPTION
7654	Filter 1-40 / 47-2150MHz for Coaxdata 200 Mbps
769220	Filter 1-68 / 87-2150MHz for Coaxdata 1 Gbps



BLOCK DIAGRAM

► 7654

Reference		7654		769220	
Bandwidth	MHz	1-40	47-2150	1-70	88-2150
Throughloss IN - FPA_OUT		35	2	35	2
Throughloss IN - FPB_OUT	dB	2	25	2	30
Isolation between inputs		37		40	

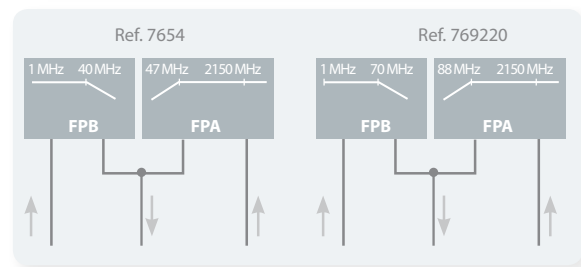

SFP Module



QR-A00172

REF.	DESCRIPTION
Optical SFM Modules for Coaxdata	
769211	SFP EPON 1F.O.
769210	SFP 1000 Base-X 2 F.O.

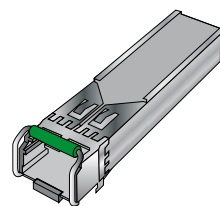

► 769211

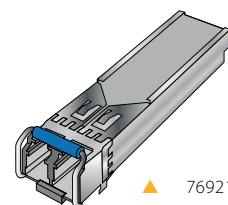

► 769210

ETHERNET COAXIAL ADAPTER

PRODUCT DESCRIPTION

Coaxdata Homeplug

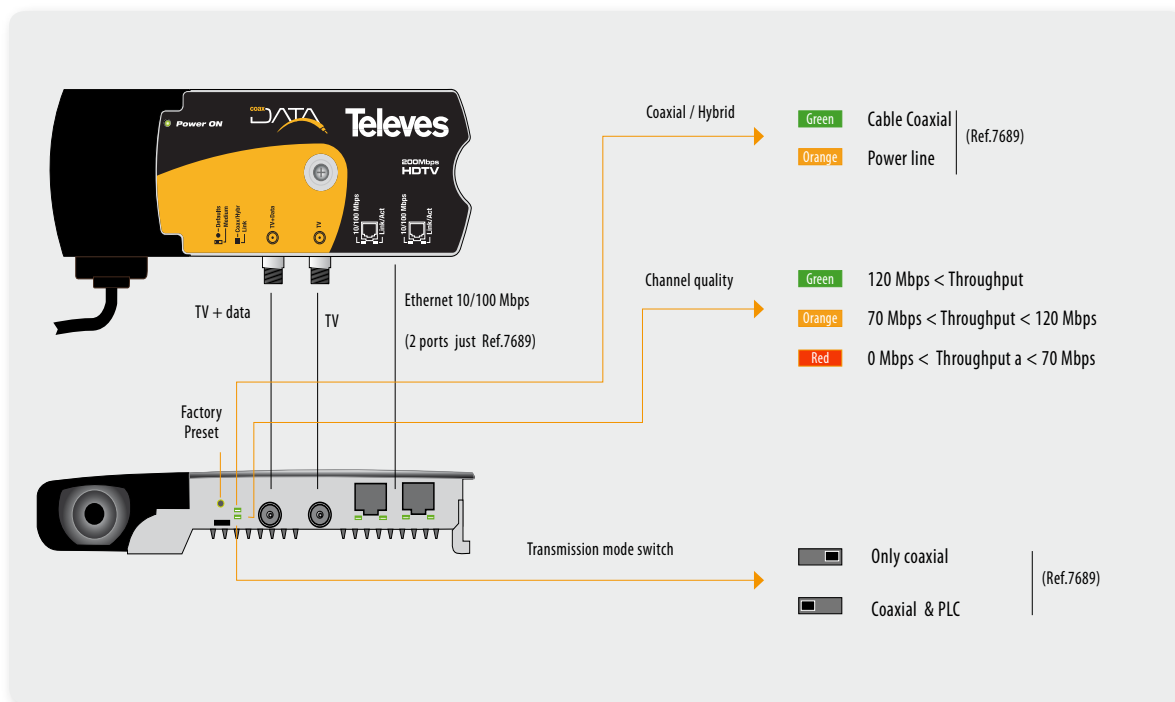

Coaxdata Gigabit

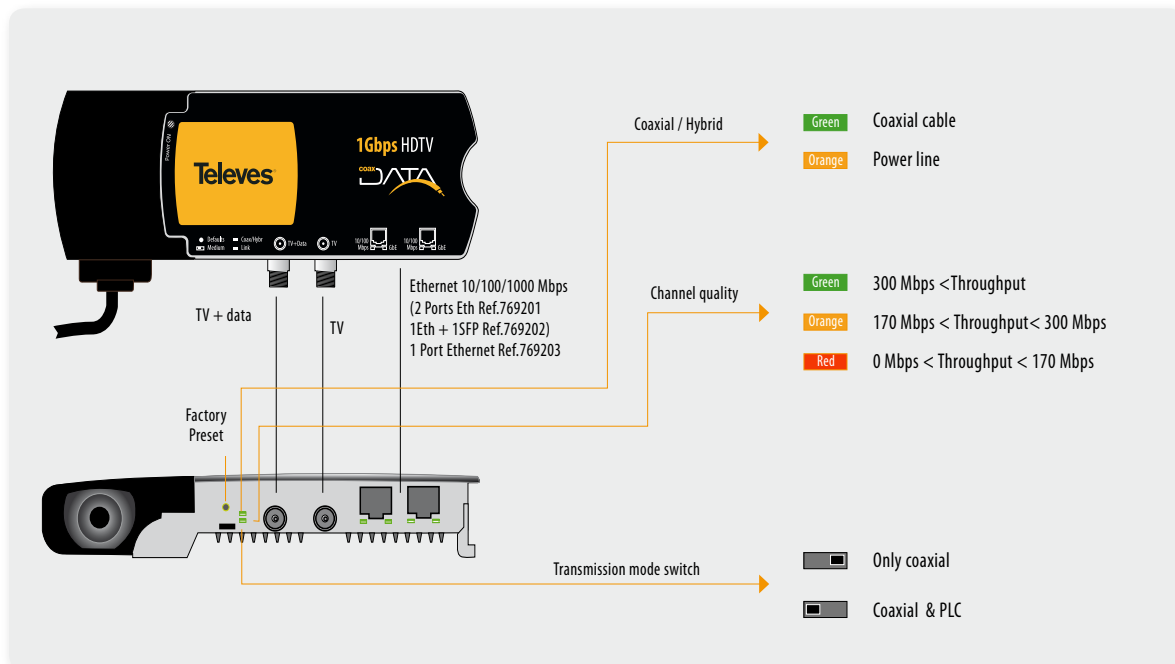

ETHERNET COAXIAL ADAPTER

Reference		7689 / 768973	769201 / 769202 / 769203
Technology		HomePlug AV	Gigabit (HomePlug AV IEEE1901)
Connection			
Data interface		2xRJ45 / 1xRJ45	2xRJ45 / 1xRJ45 + 1xSFP / 1xRJ45
Ethernet ports	Mbps	10/100	10/100/1000
Coaxial interface		2 x F (TV + data)	
Coaxial data interface			
Bandwidth	MHz	2 - 30	2 - 67,5
Output level	dB μ V	130	
Output impedance	Ω	75	
Max. attenuation	dB	85	
Coaxial TV interface			
Bandwidth	MHz	57 ... 2150	87 ... 2150
Insertion loss		2	
Return loss	dB	> 10	
Output impedance	Ω	75	
Power supply / Temperature			
Voltage (50/60 Hz)	Vac	100 - 264	108 - 254
Max. consumption	W	5	6 (1,8 by low consumption mode)
Working temperature	$^{\circ}$ C	-10 a +45	
Firmware			
Number of supported slaves	no.	253 (1012 with 4 masters)	
Maximum length of coaxial network	m	800	1200

Home Networking

Coaxial option

One of the most typical applications of the CoaxData-200Mbps-HDTV modem, is used to share the services of your Internet provider at home.

Using the modem, you will get access to the services provided by your ISP such as the Internet access, video streaming or VoIP throughout the home without requiring additional infrastructure.

The following diagram shows a prototype facility in which a user can access the different services provided by the Internet, anywhere in the house.

You can also share printers and media servers located in other rooms of the same.

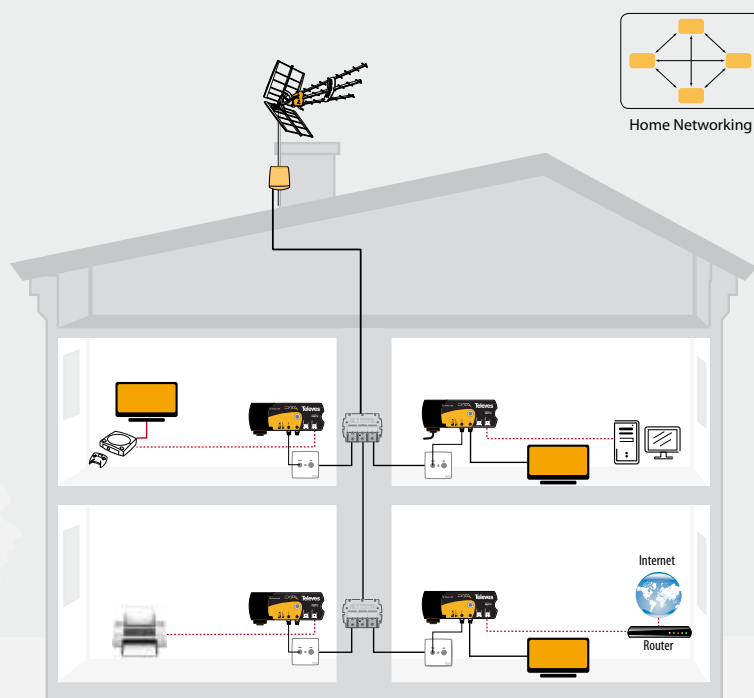

Share printer, NAS Media Server, the Internet, ... on the same network

Home Networking

PLC Mode

The Coax Data 200Mbps-HDTV adapter is factory configured to be able to perform a Home Networking plug-and-play installation. This allows for the creation of a LAN, where all the devices communicate with each other (peer-to-peer).

In this application it is used the electric network infrastructure of the house for data transmission (PLC).

The main benefit of this application is based on the fact that the electrical network reaches every corner of the home.

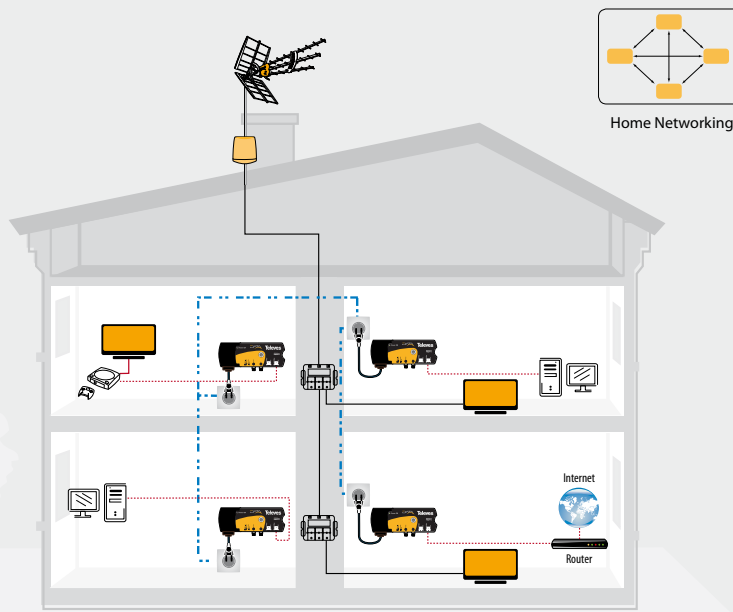

Hybrid Mode

The Coax Data 200Mbps-HDTV adapter is factory configured to be able to perform a Home Networking plug-and-play installation. This allows for the creation of a LAN, where all the devices communicate with each other (peer-to-peer).

In this application it is used both coaxial cable and electric infrastructures of the house for data transmission (COAX + PLC).

In other words, whichever electric or coaxial outlet can be a LAN point.

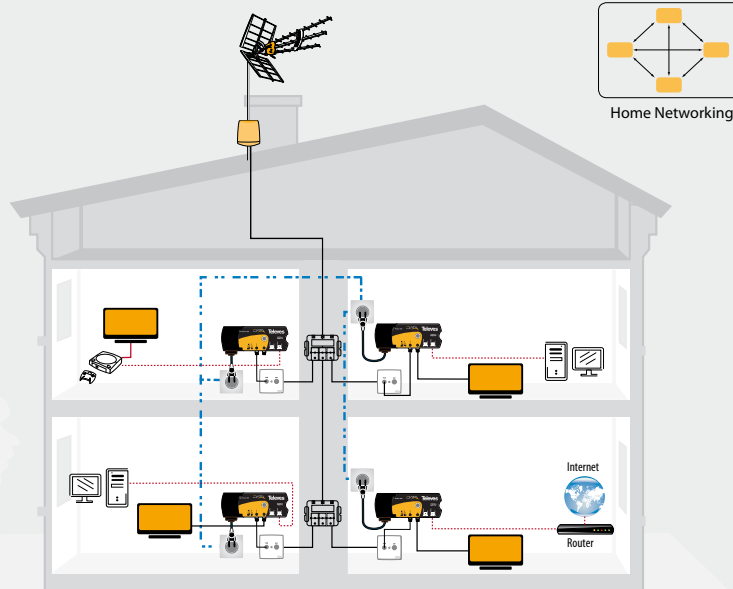

MXU MODE

Coaxial distribution

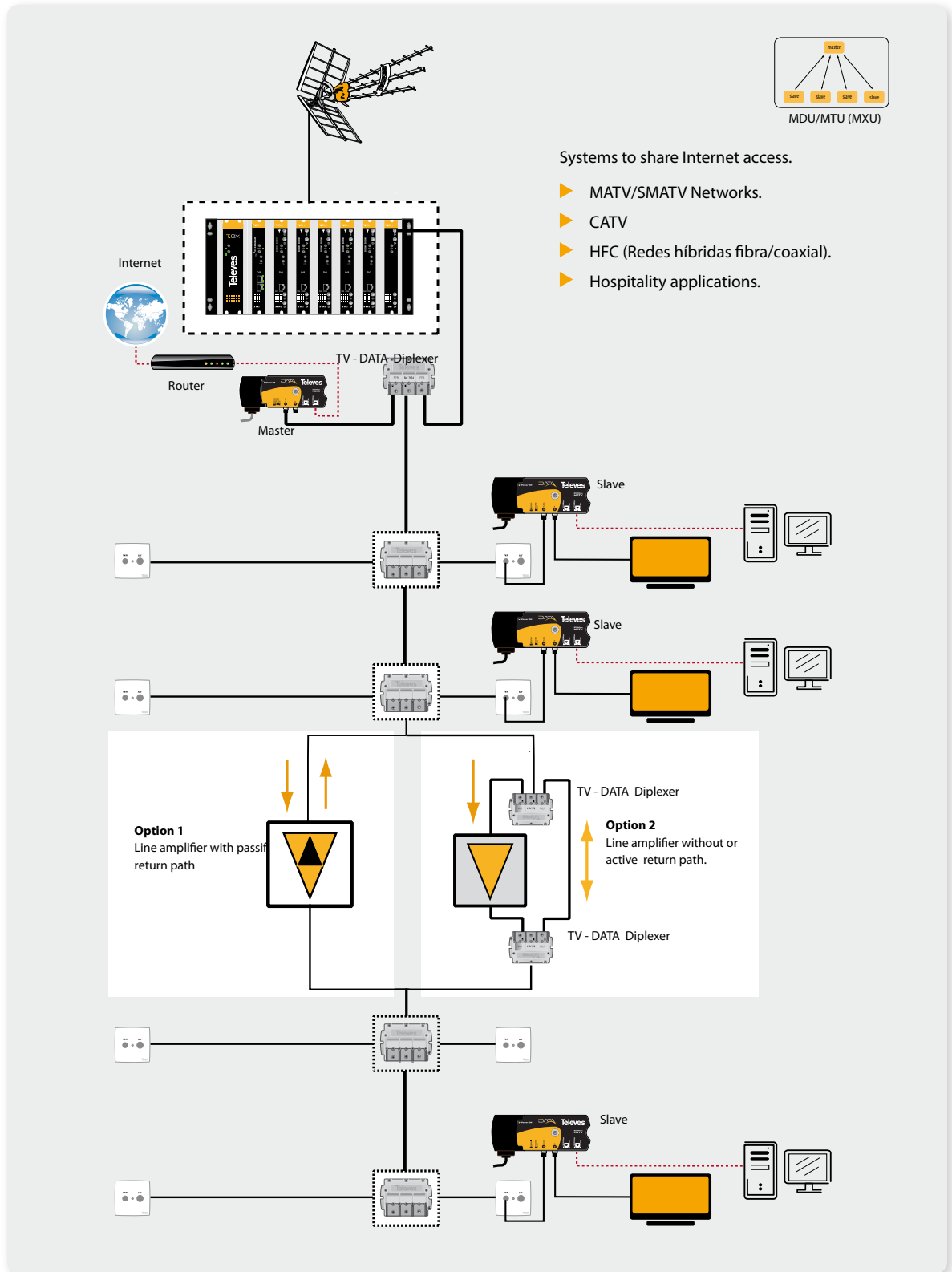

P2P Solution : Ethernet over fiber 1000Base-X

Using Ethernet adapter ref.769202

By means of an SFP module the Gigabit Coaxdata allows the connection with the optical network of a provider.

In the following application it can be seen an example of a system with 8 branches using three fibers each. Two fibers for the data communications and a third for RF Overlay. The last part of the network is distributed through the coaxial network.

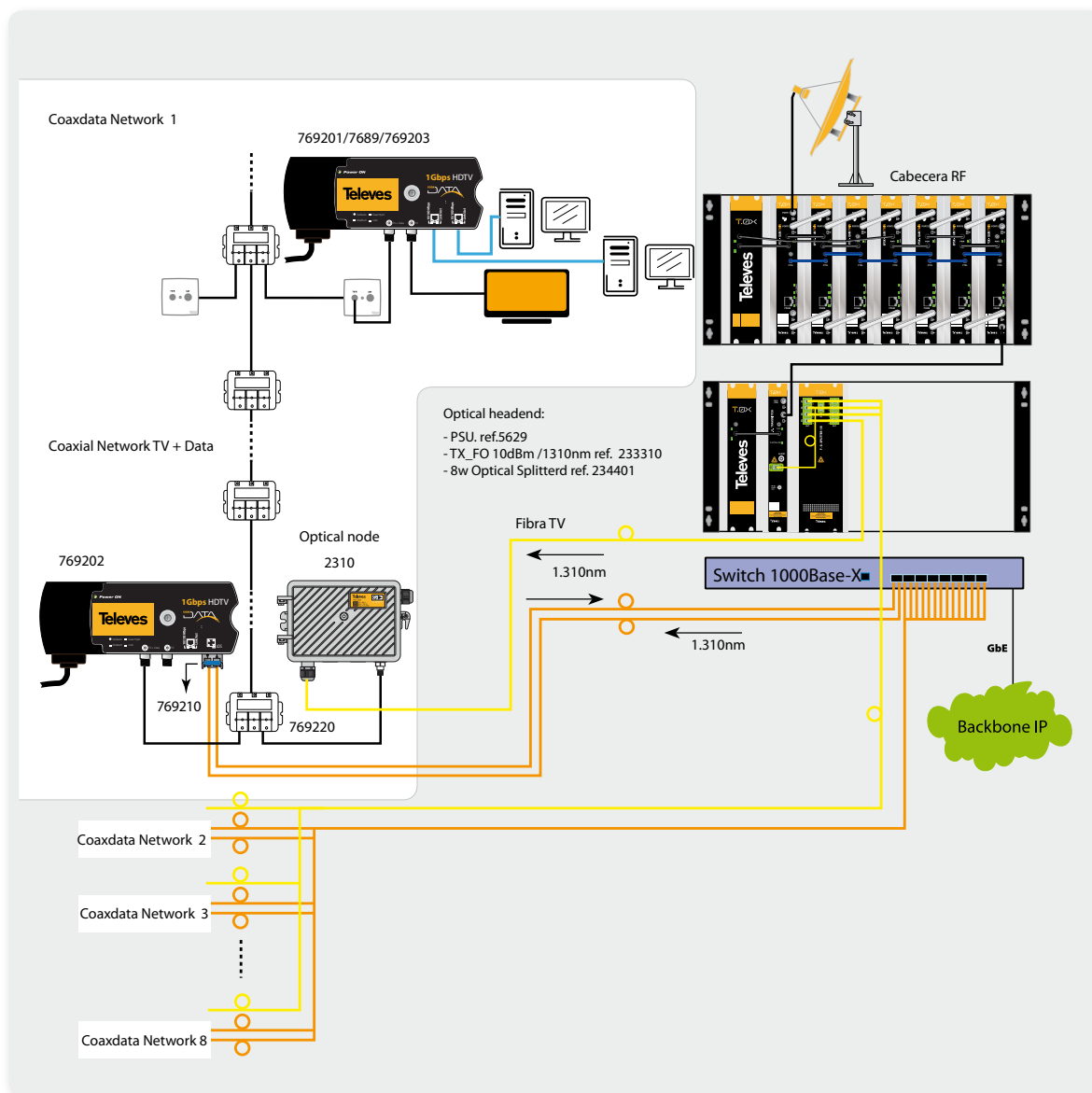

OPTICAL NETWORK

EPON Solution

Using adapter ref.769202

Three optical windows are multiplexed to be able to distribute data download, upload and TV RF Overlay. For data transmission lamdas 1490/1310nm are implemented. For RF distribution (RFOG) 1550nm is used. This configuration allows the distribution through an Passive Optical Network (PON).

The SFP Module used has to be compatible with the OLT deployed in the headend. A WDM has to be used both at the headend and at the optical nodes.

In the example its shown an application with 64 EPON lines, each of them feeding a coaxial network.

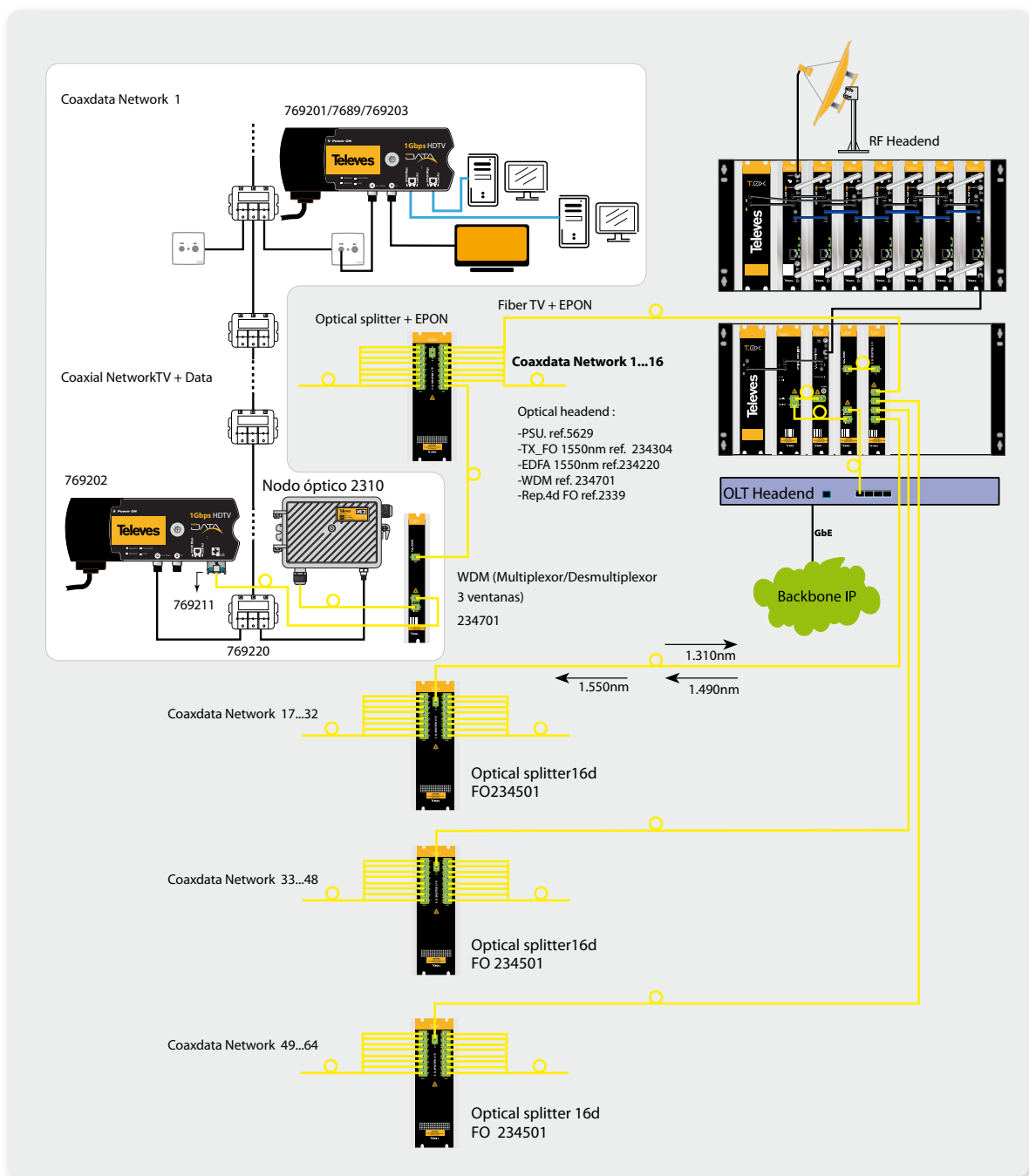

CoaxManager Software

This tool allows the configuration of the working mode and parameters of the system. As well as an evaluation of the transmission channel of each device.

- ▶ Configuration of the working mode Home Networking or MXU.
- ▶ Establishment of private networks (Encryption).
- ▶ QoS configuration.
- ▶ Limit of number of MAC Adresses per slave.
- ▶ IGMP (Internet Group Management Protocol) configuration.
- ▶ Detailed información of the SNR, attenuation, tone map which allows to evaluate the performance of the system.
- ▶ Firmware update.

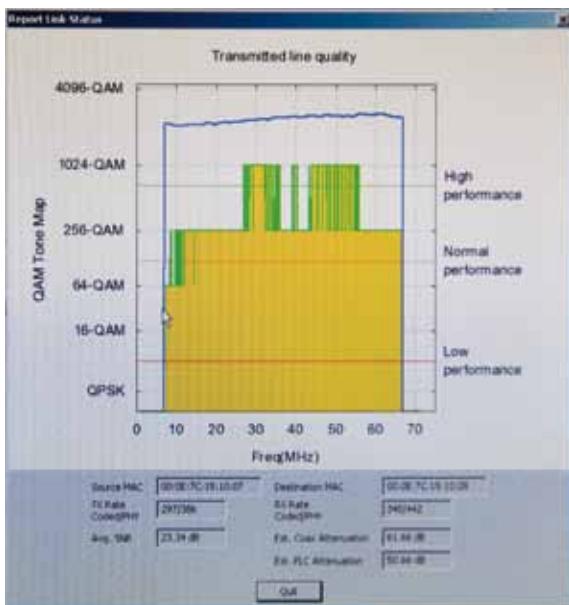

Channel evaluation window for the Gigabit Coaxdata

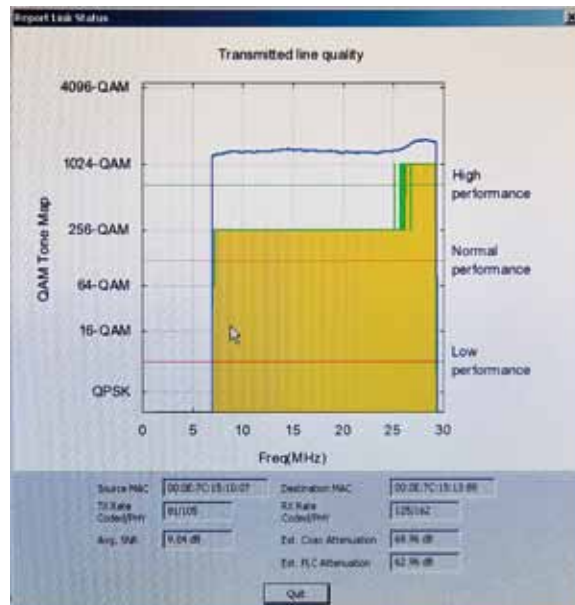

Channel evaluation window for the Homeplug Coaxdata

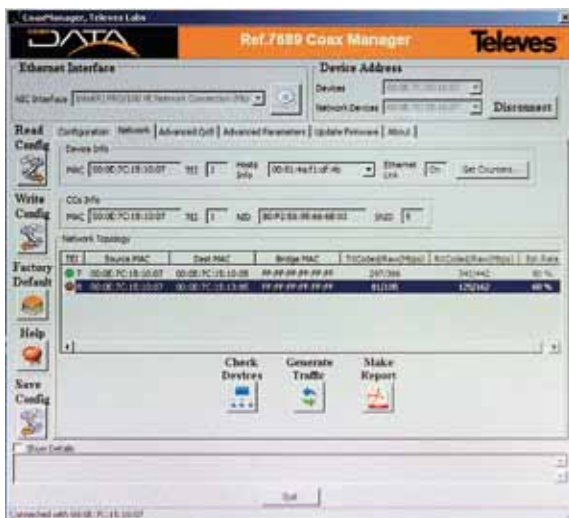

Network parameters window



Configuration window