

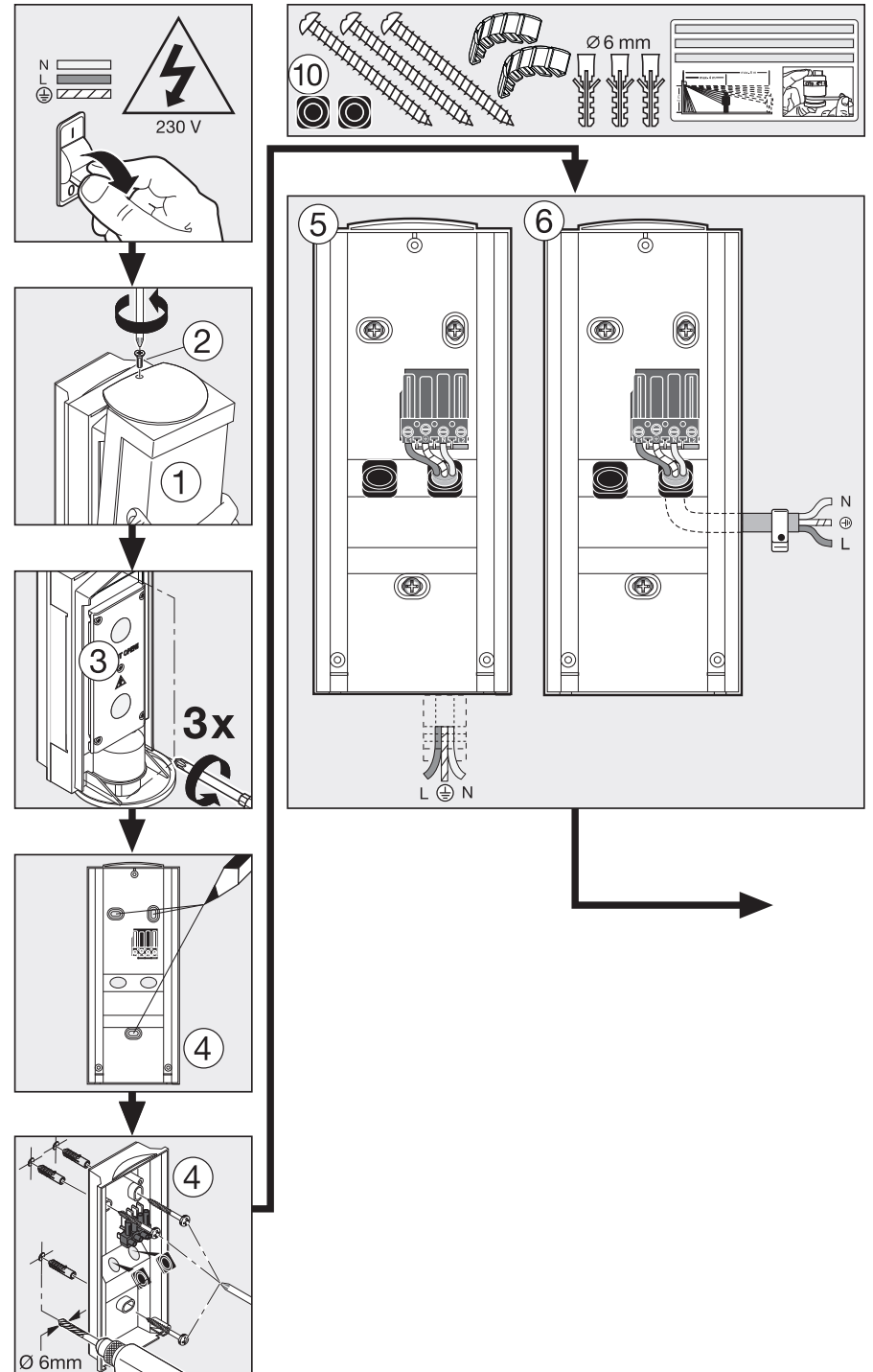

**FI Oy Hedtec Ab**  
Lauttasaarentie 50  
FI-00200 Helsinki  
Tel.: +358/207 638 000  
Fax: +358/9/673 813  
lighting@hedtec.fi  
www.hedtec.fi/valaistus

11020876 08/2016\_J Technische Änderungen vorbehalten. / Subject to technical modification without notice.

Information  
**L 665 LED / L 666 LED**

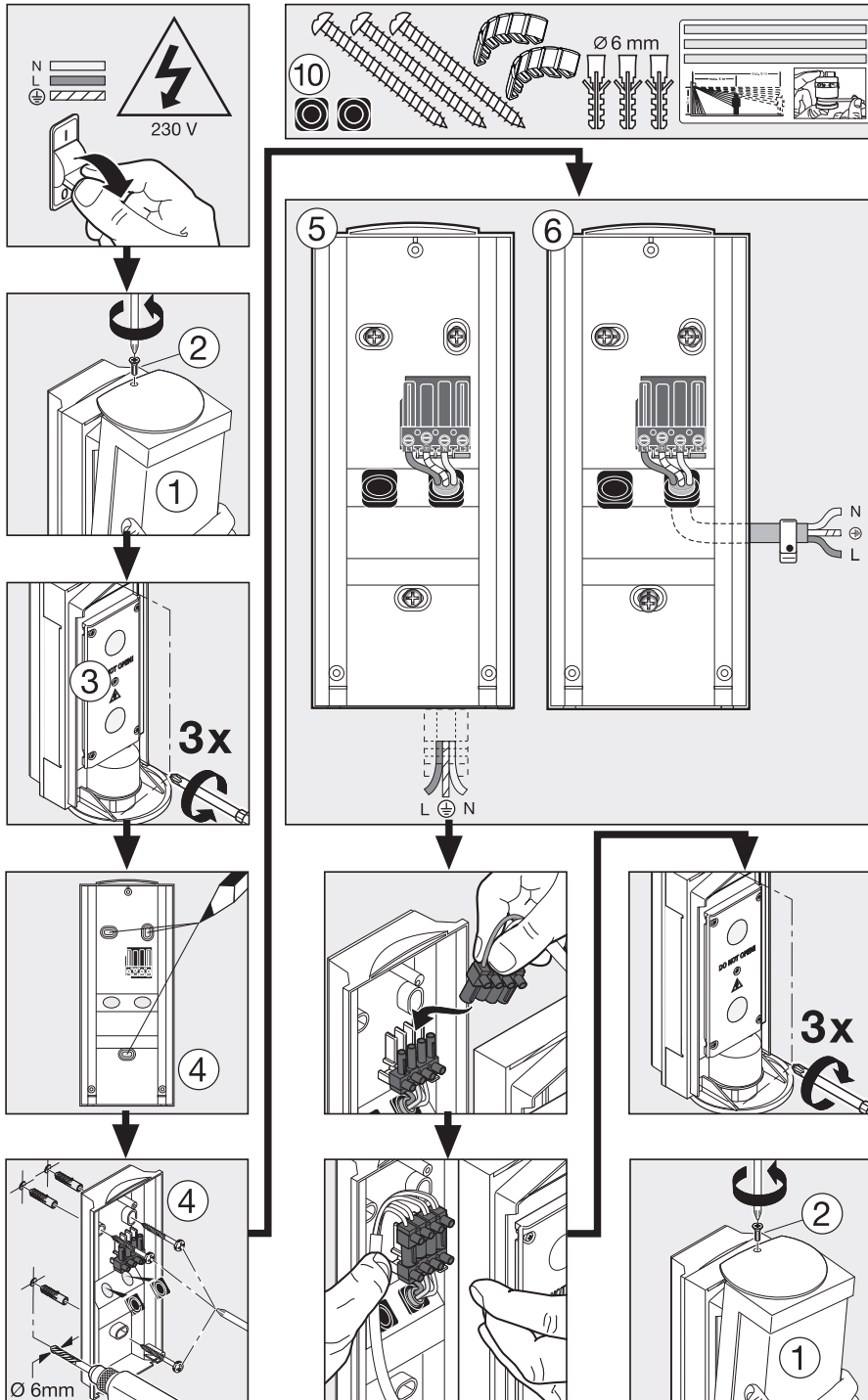

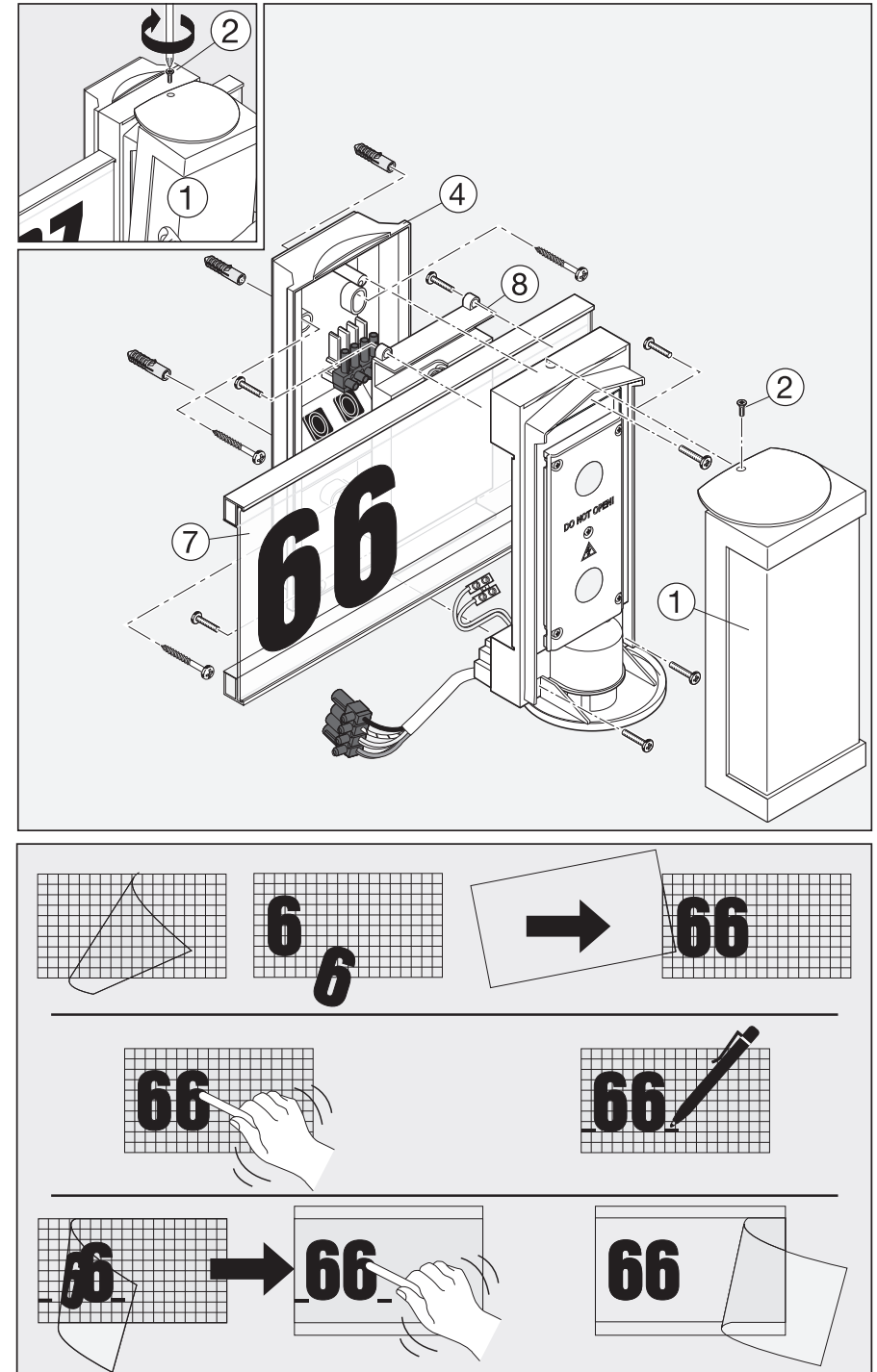
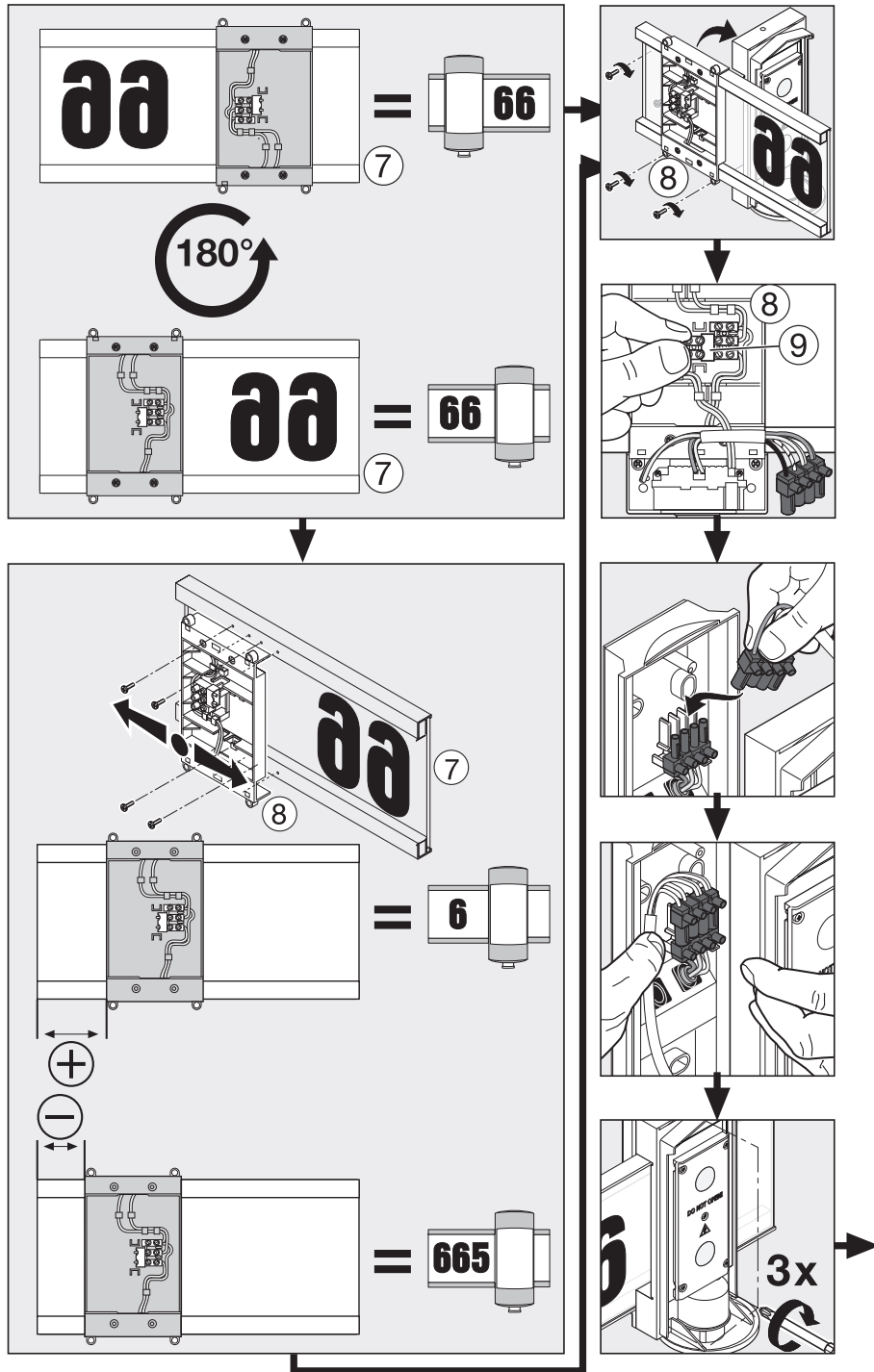

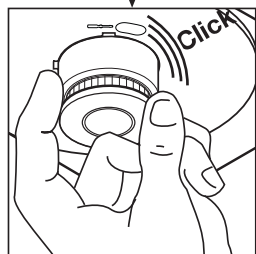
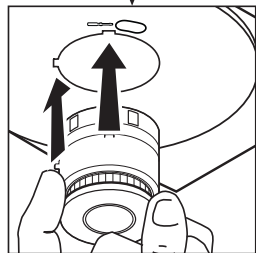
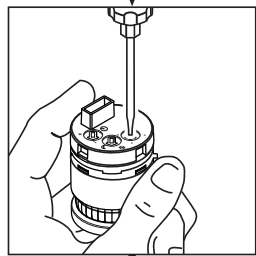
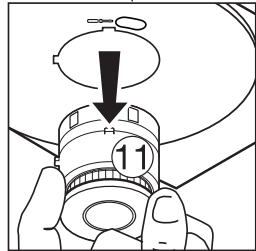
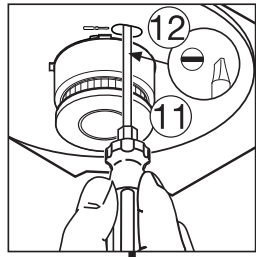

<b>P</b>		<b>1</b>
	25%	<b>2</b>
	25%  1/2	<b>3</b>
	ON OFF	<b>4</b>

2 - 2000 Lux

5 sec. - 15 min.

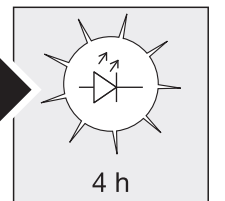
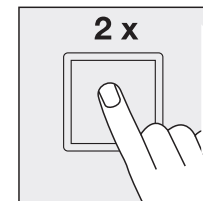
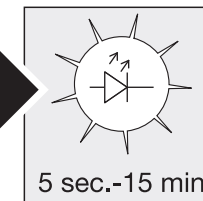
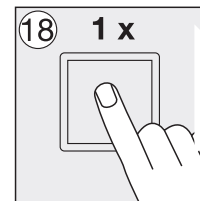
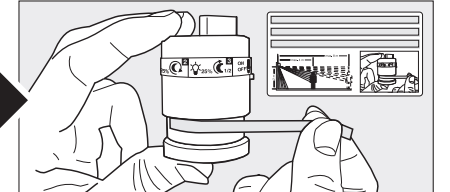
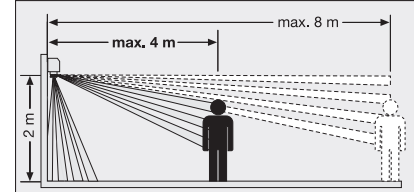
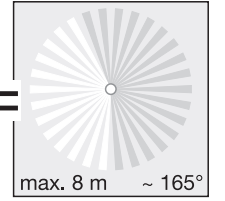
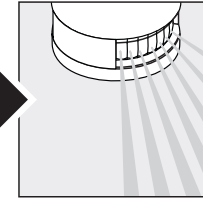
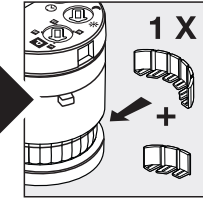
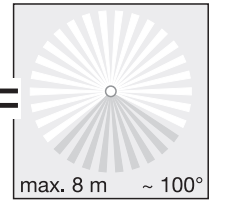
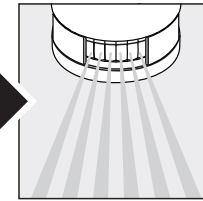
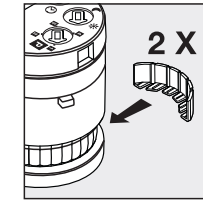
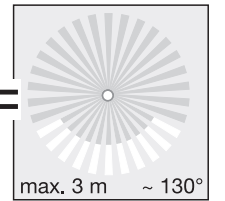
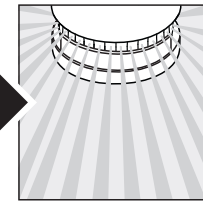
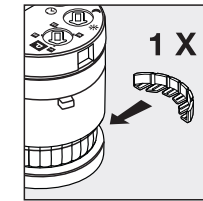
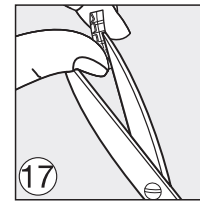
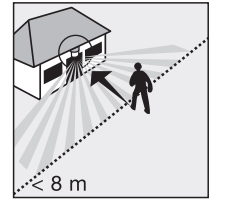
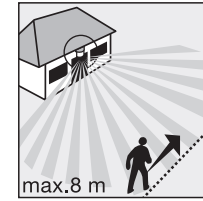
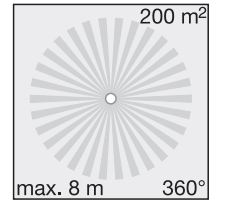
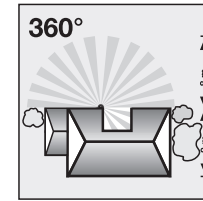
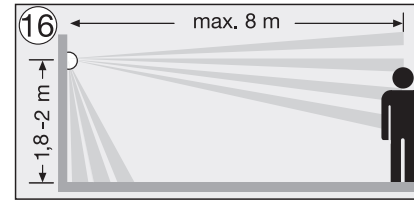

## GB Installation instructions

### Dear Customer,

Congratulations on purchasing your new STEINEL SensorLight and thank you for the confidence you have shown in us. You have chosen a high-quality product that has been manufactured, tested and packed with the greatest care.

Please familiarise yourself with these instructions before attempting to install the SensorLight because prolonged reliable and trouble-free operation will only be ensured if it is fitted properly. We hope your new STEINEL SensorLight will bring you lasting pleasure.

### System components

- ① Glass shade
- ② Glass shade locking screw
- ③ Light housing
- ④ Wall mount
- ⑤ Mains power supply lead, concealed
- ⑥ Mains power supply lead, surface-mounted

#### L 665 LED only:

- ⑦ LED illuminated panel, turns through 180° for installing on the right or on the left of the front door
- ⑧ Movable holder for LED illuminated panel permitting adjustment for 3-digit numbers.

- ⑨ LED illuminated panel plugs into light housing
- ⑩ Sealing plug
- ⑪ Sensor unit (removes for ease of setting functions)
- ⑫ Engagement lug for removing sensor unit
- ⑬ Time setting
- ⑭ Twilight setting
- ⑮ Programme setting
- ⑯ Principle
- ⑰ Adjusting the detection zone
- ⑱ Manual override

### Principle ⑯

The integrated high-performance infrared sensor is equipped with a double 360° sensor that detects the invisible heat emitted by moving objects (persons, animals etc.).

The heat detected in this way is converted electronically into a signal that switches the light ON automatically. Heat is not detected through obstacles, such as walls or panes of glass. Heat radiation of this type will, therefore, not trigger the sensor. The unit achieves a coverage angle of 360°

with an aperture angle of 90°. A sneak-by guard ensures coverage below the sensor.

**Important:** The most reliable way of detecting motion is to install the SensorLight with the sensor aimed across the direction in which a person would walk and by ensuring that no obstacles (such as trees and walls, for example) obstruct the line of sensor vision. Reach is limited when walking directly towards the light.

### ⚠ Safety warnings

- Disconnect the power supply before attempting any work on the unit.
- During installation, the electrical wiring you are connecting must be dead. Therefore, switch off the power first and use a voltage tester to make sure the wiring is off circuit.

- Installing the SensorLight involves work on the mains voltage supply. This work must therefore be carried out professionally in accordance with the applicable national wiring regulations and electrical operating conditions.  
(D) - VDE 0100, (A) - ÖVE/ÖNORM E8001-1, (CH) - SEV 1000

### Installation

The site of installation should be at least 50 cm away from another light because heat radiated from it may activate the system. To obtain the specified reach of 8 m, the sensor should be installed at a height of approx. 1.8 – 2 m.

#### Connecting the mains supply lead (see illustration)

The mains lead consists of a 3 phase cable.

**L** = phase conductor (usually black or brown)

**N** = neutral conductor (usually blue)

**PE** = protective earth conductor (green/yellow) ⊕

If you are in any doubt, identify the conductors using a voltage tester; then switch off the power again. Connect phase (**L**), neutral (**N**) and protective earth conductor (**PE**) to the terminal block.

**Note:** A mains switch for switching the unit ON and OFF may of course be installed in the mains supply lead. A mains switch is required for the manual override function (see Manual override function) ⑱.

**Important:** To ensure that all metal parts are earthed, the light must only be connected to the mains power supply once it is fully assembled.

## Functions ⑬, ⑭, ⑮

The removable sensor unit accommodates dials for selecting the time, twilight and programme settings. After pressing the engagement lug ⑫ with a flat-bladed

screwdriver, the sensor unit can be removed for ease of setting. When the sensor is removed, the light automatically switches to constant output.

#### Switch-off delay (time setting) ⑬ (factory setting: 5 sec.)

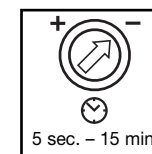

Light ON time can be adjusted continuously from 5 sec. to 15 min.

Control dial set to - = shortest time (5 sec.)  
Control dial set to + = longest time (15 min.)

To set the detection zone, it is recommended to select the shortest time -.

#### Twilight setting (response threshold) ⑭ (factory setting: daylight operation 2000 lux)



The sensor's response threshold can be infinitely varied from 2 – 2000 lux.

Control dial set to ☀ = daylight operation approx. 2000 lux.  
Control dial set to ☾ = night-time operation approx. 2 lux.

To adjust the detection zone in daylight, the control dial must be set to ☀ (daylight operation).

#### Programme setting ⑮ (factory setting: programme 1)

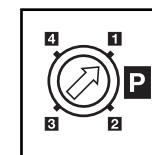

##### 1 Standard programme:

- Soft light start / no basic lighting level
- LED illuminated panel ON when ambient light level reaches twilight setting (L 665 LED)

##### 2 Comfort programme:

- Soft light start + basic lighting level
- LED illuminated panel ON when ambient light level reaches twilight setting (L 665 LED)

##### 3 LED comfort economy programme:

- Soft light start + basic lighting level to middle of the night \*
- LED illuminated panel ON from twilight setting to middle of the night (L 665 LED)

##### 4 Normal programme:

- No soft light start / no basic lighting level
- LED illuminated panel ON only in response to movement (L 665 LED)



\* Note comfort economy programme 3:

The sensor light does not have any integrated clock. The middle of the night is only determined on the basis of the length of darkness phases. To work perfectly, therefore, it is important for the SensorLight to be permanently connected to the power supply during this period. During the first night (calibration phase) basic lighting level remains activated throughout the night. Values remain saved even in the event of mains power failure.

We recommend not to interrupt the power supply in programme 3. As the values are determined over several nights, the SensorLight should, in the event of any fault, be observed over several nights to ascertain whether the switch-off time moves towards midnight.

#### What is soft light start?

The SensorLight comes with a soft light start function. This means that when the light is switched ON, it does not go directly to maximum output but gradually

increases brightness to 100 % over the space of one second. Brightness is also gradually reduced when the light is switched OFF.

#### What is basic lighting level?

Basic lighting level provides continuous night-time illumination at approx. 25 % light output. The light only switches to maximum output of 100 % (for the time selected, see Switch-off delay ⑬) in response to movement in the detection zone. The light then returns to basic lighting level (approx. 25 %).

**Note:** Depending on the local power grid, the LED's may flicker slightly when dimmed. This is not a product defect and no reason for complaint.

## Adjusting the detection zone ⑰

The detection zone can be limited to suit requirements. The shrouds supplied with the light can be used to mask out as many lens segments as you wish. This prevents the light from being activated unintentionally, e.g. by cars, passers-by etc., and allows you to target danger

spots. The shrouds can be cut along the pre-grooved vertical divisions. Then you simply clip them onto the lens.

## Manual override function ⑱

If a mains switch is installed in the mains supply lead, the light is capable of the following functions in addition to the simple ON/OFF function:

### Sensor operation

#### 1) Switch light ON (when light is OFF):

Turn switch OFF and ON once.

Light stays ON for the period selected.

#### 2) Switch light OFF (when light is ON):

Turn switch OFF and ON once.

The light goes out or switches over to sensor mode.

### Manual override

#### 1) Activate manual override:

Turn switch OFF and ON twice. The light is set to stay ON for 4 hours (red LED lights up behind lens). Then it returns automatically to sensor mode (red LED off).

#### 2) Deactivate manual override:

Turn switch OFF and ON once. The light goes out or switches over to sensor mode.

### Important:

The switch should be actuated in rapid succession (in the 0.5 – 1 sec. range).

## Technical specifications

Dimensions (H x W x D):	270 x 328 x 141 mm (L 665 LED) 270 x 100 x 141 mm (L 666 LED)
Mains voltage:	230 – 240 V, 50 Hz
Output:	L 665 LED: 8 W LED main lighting 1 W LED street number lighting 155 lm L 666 LED: 8 W LED main lighting 150 lm
Colour temperature:	3200 kelvin (warm white)
LED life expectancy:	50.000 hours
Angle of coverage:	360° with sneak-by guard
Detection reach:	8 m all round
Twilight setting:	2 – 2000 lux
Time setting:	5 sec. – 15 min.
Basic lighting level:	0 or 25%, soft light start
Manual override:	4 hours, switchable
IP rating:	IP 44
Protection class:	I
Temperature range:	- 20° C to + 50° C

## Operation / Maintenance

The SensorLight is suitable for switching light ON automatically. Weather conditions may affect the way the SensorLight functions. Strong gusts of wind, snow, rain or hail may cause the light to come ON when it is not wanted because the sensor is unable to distinguish

sudden changes of temperature from sources of heat. The detector lens may be cleaned with a damp cloth if it gets dirty (do not use cleaning agents).

## CE Declaration of conformity

This product complies with  
- Low Voltage Directive 2006/95/EC  
- EMC Directive 2004/108/EC

- RoHS Directive 2011/65/EC  
- WEEE Directive 2012/19/EC

## Troubleshooting

Malfunction	Cause	Remedy
SensorLight without power	<ul style="list-style-type: none"> <li>■ Fuse faulty, not switched ON, break in wiring</li> <li>■ Short circuit</li> </ul>	<ul style="list-style-type: none"> <li>■ Fit new fuse; switch ON mains switch; check wiring with voltage tester</li> <li>■ Check connections</li> </ul>
SensorLight will not switch ON	<ul style="list-style-type: none"> <li>■ Twilight control set to night-time during daytime operation</li> <li>■ Power switch OFF</li> <li>■ Fuse faulty</li> <li>■ Detection zone not properly targeted</li> <li>■ Internal electrical fuse has been activated (red LED flashing rapidly)</li> <li>■ Mains terminal not connected properly</li> </ul>	<ul style="list-style-type: none"> <li>■ Re-adjust (control ⑭)</li> <li>■ Switch ON</li> <li>■ New fuse, check connection if necessary</li> <li>■ Re-adjust</li> <li>■ Switch SensorLight OFF and back ON again after 5 sec.</li> <li>■ Firmly press terminal together properly</li> </ul>
SensorLight will not switch OFF	<ul style="list-style-type: none"> <li>■ Continued movement within the detection zone</li> <li>■ Sensor unit is not properly engaged</li> </ul>	<ul style="list-style-type: none"> <li>■ Check detection zone and re-adjust if necessary</li> <li>■ Lightly press sensor unit to clip it into place</li> </ul>
Basic lighting level does not go out at about midnight as desired	<ul style="list-style-type: none"> <li>■ External light source (e.g. other motion detector or light) inactivating the SensorLight</li> </ul>	<ul style="list-style-type: none"> <li>■ Shade SensorLight from extraneous light, observe SensorLight for several days as it takes time to return to the correct value</li> </ul>
SensorLight will not switch OFF completely	<ul style="list-style-type: none"> <li>■ Basic lighting level selected</li> </ul>	<ul style="list-style-type: none"> <li>■ Turn programme selector dial to 1</li> </ul>
SensorLight switching ON when it should not	<ul style="list-style-type: none"> <li>■ Wind is moving trees and bushes in the detection zone</li> <li>■ Cars in the street are being detected</li> <li>■ Sudden temperature change due to weather (wind, rain, snow) or air expelled from fans, open windows</li> </ul>	<ul style="list-style-type: none"> <li>■ Change detection zone</li> <li>■ Change detection zone</li> <li>■ Change detection zone, change site of installation</li> </ul>
Change in SensorLight reach	<ul style="list-style-type: none"> <li>■ Differing ambient temperatures</li> </ul>	<ul style="list-style-type: none"> <li>■ Use shrouds to define detection zone precisely</li> </ul>
Red LED flashing rapidly	<ul style="list-style-type: none"> <li>■ Internal fuse activated</li> </ul>	<ul style="list-style-type: none"> <li>■ Switch SensorLight OFF and back ON again after 5 sec.</li> </ul>
LED illuminated panel not operating	<ul style="list-style-type: none"> <li>■ Terminal not pushed in all the way</li> </ul>	<ul style="list-style-type: none"> <li>■ Firmly press terminal together</li> </ul>
LED illuminated panel OFF although it is dark	<ul style="list-style-type: none"> <li>■ Programme 3 or 4 selected</li> </ul>	<ul style="list-style-type: none"> <li>■ Change programme</li> </ul>
LEDs flickering	<ul style="list-style-type: none"> <li>■ Local power grid</li> </ul>	<ul style="list-style-type: none"> <li>■ see note on page 13</li> </ul>

## Functional Warranty

This STEINEL product has been manufactured with great care, tested for proper operation and safety in accordance with applicable regulations and then subjected to random sample inspection. STEINEL guarantees that it is in perfect condition and proper working order. The warranty period is 36 months, starting on the date of sale to the consumer. We will remedy defects caused by material flaws or manufacturing faults. The warranty will be met by repair or replacement at our own discretion. The warranty shall not cover damage to wear parts, damage or defects caused by improper treatment or maintenance. Further consequential damage to external items is excluded.

Claims under warranty shall only be accepted if the product is sent fully assembled and well packed complete with a brief description of the fault, a receipt or invoice (date of purchase and dealer's stamp) to the appropriate service centre.

### Repair Service:

Please ask your nearest service centre how to proceed for repairing faults not covered by the warranty or occurring after the warranty expires.

**36 month**  
FUNCTIONAL  
WARRANTY