

Aura Notum Pendulum, Ø 300 DALI

Installation instructions

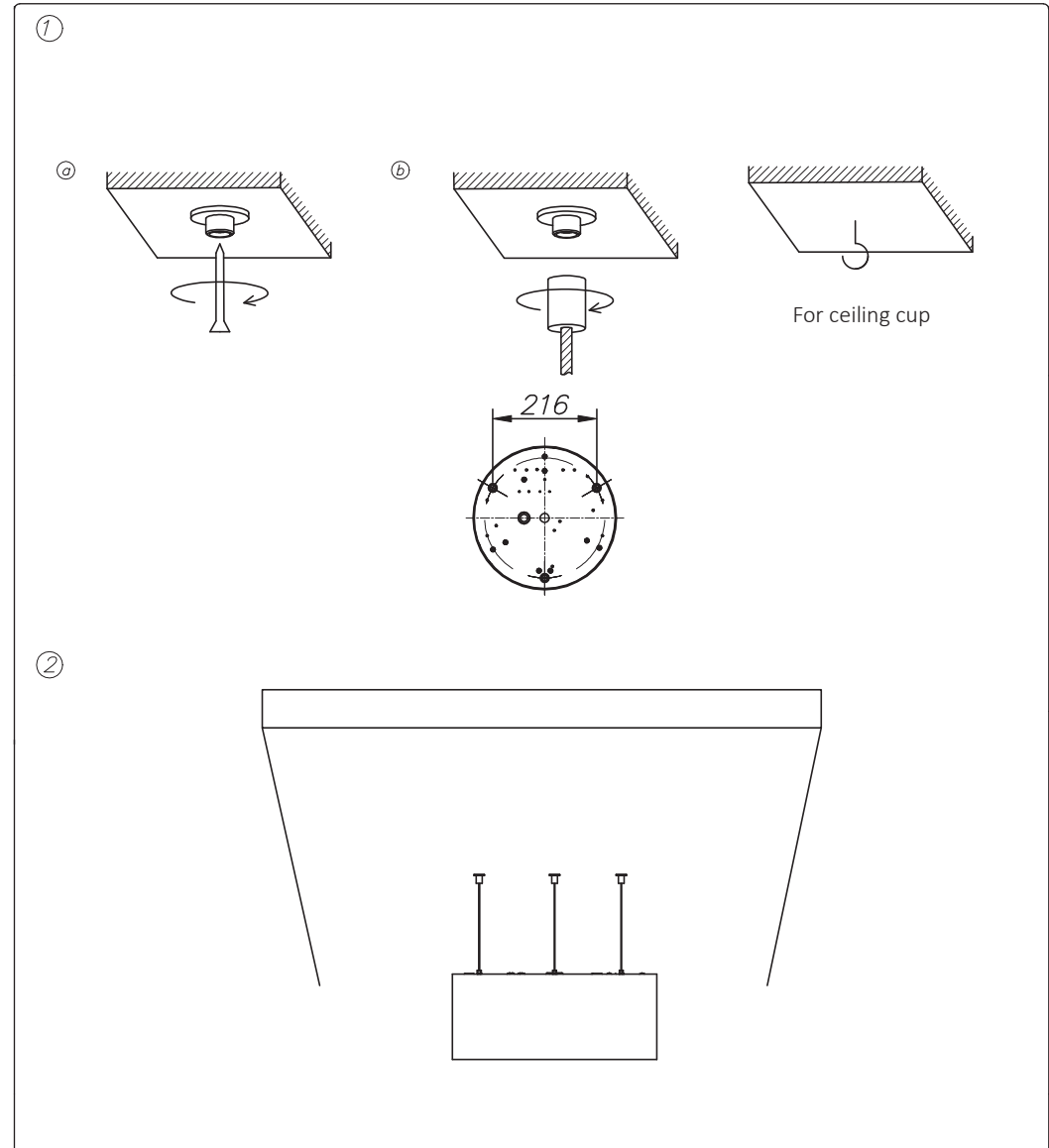
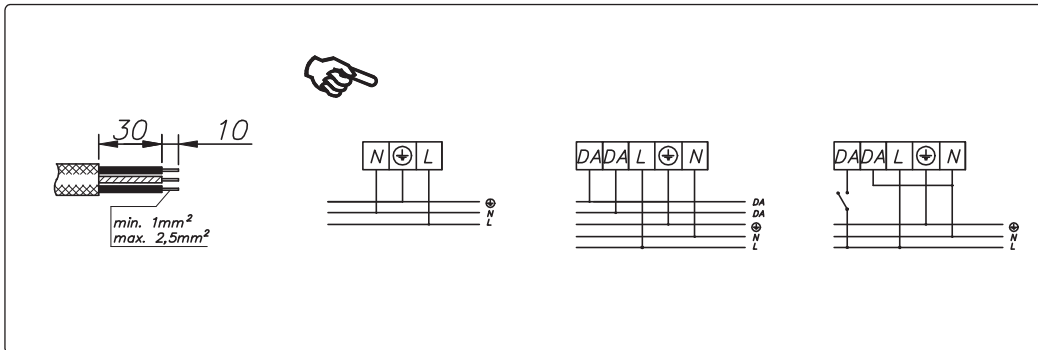
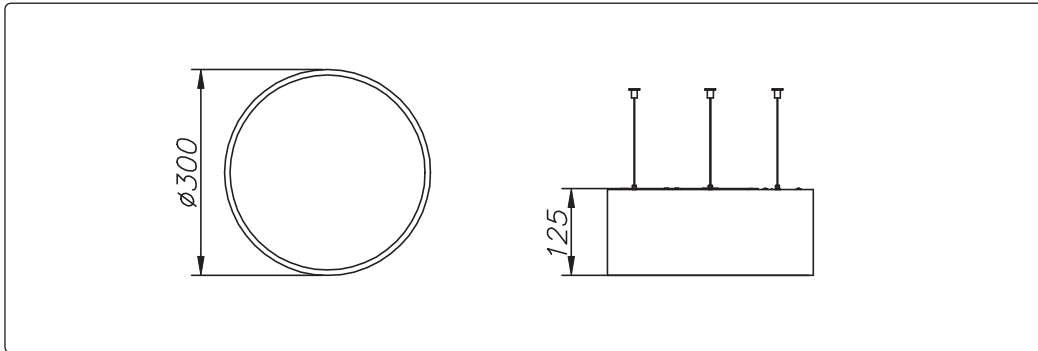

UK - Disconnect the unit before changing the lamp.
 F - Debrancher l'appareil avant de changer la lampe.
 D - Von den Auswechseln der lampe die Leuchte von der Netzspannung trennen.