

Technical catalogue 2017

S800/S500

The High Performance MCB



Table of content

Overview	page 0/4	1
S800		
Ordering details	page 1/1	2
Properties	page 2/1	
Technical data	page 3/1	3
Dimensional drawings	page 4/1	
Approvals	page 5/1	
S500		
Ordering details	page 6/1	4
Properties	page 7/1	
Technical data	page 8/1	5
Dimensional drawings	page 9/1	
Approvals	page 10/1	6

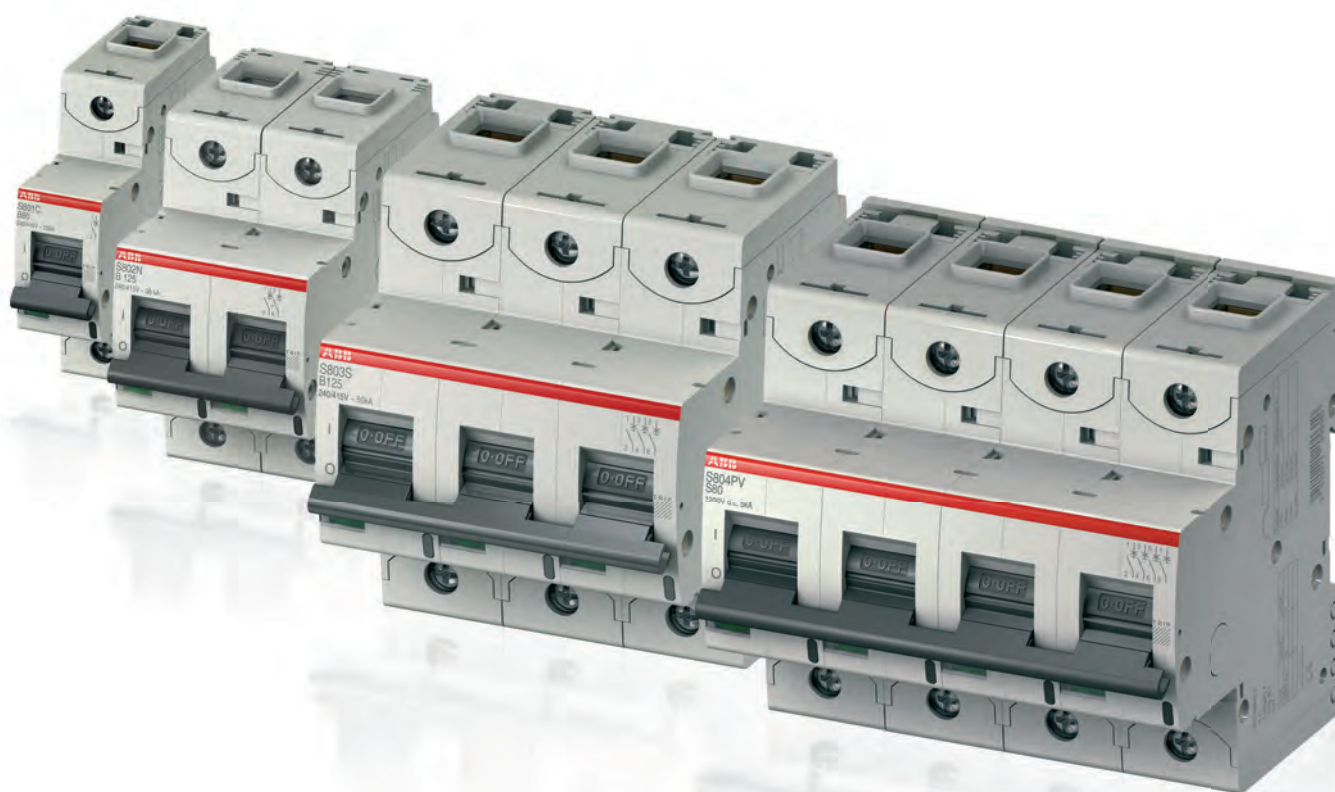

Overview S800

	S800S B, C, D, K	S803S-KM KM	S800S-UC UCB, UCK	S800N B, C, D	S800C B, C, D, K
Tripping characteristics					
Standards	IEC/EN 60947-2, IEC/EN 60898-1	IEC/EN 60947-2	IEC/EN 60947-2	IEC/EN 60947-2, IEC/EN 60898-1	IEC/EN 60947-2, EN 60898-1
Poles	1 ... 4	3	1 ... 4	1 ... 4	1 ... 4
Rated current I_n	A 6 ... 125	20 ... 80	10 ... 125	6 ... 125	10 ... 125
Rated frequency f	Hz 50/60	50/60	50/60	50/60	50/60
Rated insulation voltage U_i acc. to IEC/EN 60664-1	V AC 690	AC 690	DC 1000	AC 690	AC 500
Rated impulse withstand voltage U_{imp} (1.2/50 μ s)	kV 8	8	8	8	8
Overvoltage category	IV	IV	IV	IV	IV
Pollution degree	3	3	1- and 2-pole: 3 3- and 4-pole: 2	3	3
Suitability for isolation	yes	yes	yes	yes	yes
Data acc. to IEC/EN 60898-1					
Rated operational voltage U_e	V AC 230/400	–	–	AC 230/400	AC 230/400
Rated short-circuit capacity I_{cn}	kA Char. B, C, D: 230/400 V (10 ... 80 A) = 25 kA	–	–	230/400 V (10 ... 80 A) = 20 kA	Char. B, C, D: 230/400 V = 15 kA
Service short-circuit capacity I_{cs}	kA Char. B, C, D: 230/400 V (10 ... 80 A) = 12.5 kA	–	–	230/400 V (10 ... 80 A) = 10 kA	Char. B, C, D: 230/400 V = 7.5 kA
Data acc. to IEC/EN 60947-2					
Rated operational voltage U_e	V AC 400/690 1-pole: DC 125 2-pole: DC 250 3-pole: DC 375 4-pole: DC 500	AC 690	1-pole: DC 250 2-pole: DC 500 3-pole: DC 750 4-pole (63 ... 125 A): DC 750 4-pole (10 ... 50 A): DC 1000	AC 400/690 1-pole: DC 125 2-pole: DC 250 3-pole: DC 375 4-pole: DC 500	AC 254/440 1-pole: DC 125 2-pole: DC 250 3-pole: DC 375 4-pole: DC 500
Rated ultimate short-circuit capacity I_{cu}	kA AC 240/415 V = 50 kA AC 254/440 V = 30 kA AC 400/690 V (up to 80 A) = 6 kA AC 400/690 V (100 ... 125 A) = 4.5 kA DC 125 V (1-pole) = 30 kA DC 250 V (2-pole) = 30 kA DC 375 V (3-pole) = 30 kA DC 500 V (4-pole) = 30 kA	AC 240/415 V = 50 kA AC 254/440 V = 30 kA AC 400/690 V = 6 kA DC 375 V = 30 kA	DC 250 V (1-pole) = 50 kA DC 500 V (2-pole) = 50 kA DC 750 V (3-pole) = 50 kA DC 750 V (4-pole) (63 ... 125 A) = 50 kA DC 1000 (4-pole) (10 ... 50 A) = 50 kA	AC 240/415 V = 36 kA AC 254/440 V = 20 kA AC 400/690 V = 4.5 kA DC 125 V (1-pole) = 20 kA DC 250 V (2-pole) = 20 kA DC 375 V (3-pole) = 20 kA DC 500 V (4-pole) = 20 kA	AC 240/415 V = 25 kA AC 254/440 V = 15 kA DC 125 V (1-pole) = 10 kA DC 250 V (2-pole) = 10 kA DC 375 V (3-pole) = 10 kA DC 500 V (4-pole) = 10 kA
Rated service short-circuit capacity I_{cs}	kA AC 240/415 V = 40 kA AC 254/440 V (up to 80 A) = 22.5 kA AC 254/440 V (100 ... 125 A) = 15 kA AC 400/690 V (up to 80 A) = 4 kA AC 400/690 V (100 ... 125 A) = 3 kA DC 125 V (1-pole) = 30 kA DC 250 V (2-pole) = 30 kA DC 375 V (3-pole) = 30 kA DC 500 V (4-pole) = 30 kA	AC 240/415 V = 40 kA AC 254/440 V = 22.5 kA AC 400/690 V = 4 kA DC 375 V = 30 kA	DC 250 V (1-pole) = 50 kA DC 500 V (2-pole) = 50 kA DC 750 V (3-pole) = 50 kA DC 750 V (4-pole) (63 ... 125 A) = 50 kA DC 1000 (4-pole) (10 ... 50 A) = 50 kA	AC 240/415 V = 30 kA AC 254/440 V (up to 80 A) = 15 kA AC 254/440 V (100 ... 125 A) = 10 kA AC 400/690 V = 3 kA DC 125 V (1-pole) = 20 kA DC 250 V (2-pole) = 20 kA DC 375 V (3-pole) = 20 kA DC 500 V (4-pole) = 20 kA	AC 240/415 V = 18 kA AC 254/440 V = 10 kA DC 125 V (1-pole) = 10 kA DC 250 V (2-pole) = 10 kA DC 375 V (3-pole) = 10 kA DC 500 V (4-pole) = 10 kA

Note: The minimum operating voltage for S800 is 12 VAC/VDC.

Overview S800

	S800B B, C, D, K	S800HV K	S800U K, Z	S804U-UCZ UCZ
Tripping characteristics				
Standards	IEC 60947-2 EN 60898-1	IEC/EN 60947-2	UL489 IEC 60947-2	UL489
Poles	1 ... 4	1 ... 3	1 ... 4	4
Rated current I _e	A Char. B, C: 32 ... 125 Char. D, K: 32 ... 125	6 ... 125	10 – 100	10 – 80
Rated frequency f	Hz 50/60	50/60	50/60	–
Rated insulation voltage U _i acc. to IEC/EN 60664-1	V AC 500	AC 1000	AC 690	DC 1500
Rated impulse withstand voltage U _{imp} (1.2/50µs)	kV 6	8	8	8
Overtoltage category	III	III	IV	IV
Pollution degree	3	2	3	3
Suitability for isolation	yes	yes	yes	yes
Data acc. to IEC/EN 60898-1				
Rated operational voltage U _e	V AC 230/400	–	–	–
Rated short-circuit capacity I _{cn}	kA 230/400 V = 10 kA	–	–	–
Service short-circuit capacity I _{cs}	kA 230/400 V = 7.5 kA	–	–	–
Data acc. to IEC/EN 60947-3				
Rated operational voltage U _e	V –	–	–	–
Min. operating voltage	V –	–	–	–
Rated short-term withstand current I _{cw}	kA –	–	–	–
Rated short-circuit making capacity I _{cm}	kA –	–	–	–
Utilisation category	–	–	–	–
Data acc. to IEC/EN 60947-2				
Rated operational voltage U _e	V AC 230/400	AC 580/1000	AC 240/415	DC 600
Rated ultimate short-circuit capacity I _{cu}	kA AC 230/400 V = 16 kA DC 75 V (1-pole) = 10 kA DC 150 V (2-pole) = 10 kA DC 225 V (3-pole) = 10 kA DC 300 V (4-pole) = 10 kA	AC 580/1000 (6 ... 63 A) = 4 kA (80 ... 125 A) = 3 kA	1-pole: AC 240 V 30 kA multipole: AC 415 V 50 kA	– –
Rated service short-circuit capacity I _{cs}	kA AC 230/400 V = 10 kA	2.5 (6 ... 63 A) 2 (80 ... 125 A)	1-pole: AC 240 V 25 kA multipole: AC 415 V 40 kA	–
Data acc. to UL / CSA				
Rated voltage	V		AC 240	DC 600
Short-circuit current rating acc. to UL 489	kA		1-pole 30 kA multipole: 50 kA	10 kA
Short-circuit current rating acc. to UL 489B	kA			

Overview S800PV Photovoltaic

	S800PV-SP	S800PV-SD	S802PV-M-H	S804U-PVS
Tripping characteristics	B	–	–	PVS
Standards	IEC / EN 60947-2 and Annex P	IEC / EN 60947-3 and Annex D	IEC / EN 60947-3	UL489B (Photovoltaic)
Poles	2 ... 4	2 ... 4	2 (polarized)	4
Rated current I_n	A 5 ... 125	32, 63, 125	32, 63, 100	5
Rated frequency f	Hz –	–	–	–
Rated insulation voltage U_i acc. to IEC/EN 60664-1	V DC 1500	DC 1500	DC 1500	DC 1500
Rated impulse withstand voltage U_{imp} (1.2/50 μ s)	kV 8	8	8	8
Overvoltage category	III	III	III	IV
Pollution degree	2	2	2	3
Suitability for isolation	yes	yes	yes	yes
Data acc. to IEC/EN 60947-3				
Rated operational voltage U_e	V –	2-pole: DC 800 3-pole: DC 1200 4-pole: DC 1500	2-pole: DC 1000	–
Min. operating voltage	V –	–	–	–
Rated short-term withstand current I_{cw}	kA –	1.5	1.5	–
Rated short-circuit making capacity I_{cm}	kA –	0.5	0.5	–
Utilisation category	–	DC-21A	DC-21A	–
Data acc. to IEC/EN 60947-2				
Rated operational voltage U_e	V 2-pole DC 800: 10 ... 125 A DC 600: 100 ... 125 A 3-pole DC 1200: 10 ... 80 A DC 1000: 100 ... 125 A 4-pole DC 1500: 10 ... 125 A	–	–	–
Rated ultimate short-circuit capacity I_{cu}	kA 5	–	–	–
Rated service short-circuit capacity I_{cs}	kA 5	–	–	–
Data acc. to UL / CSA				
Rated voltage	V			DC 1000
Short-circuit current rating acc. to UL 489	kA			
Short-circuit current rating acc. to UL 489B	kA			3 kA

Overview S500

	S500	S500UC
Tripping characteristics	K	K
Standards	IEC/EN 60947-2 UL1077 CAN/CSA-C22.2 No. 35	IEC/EN 60947-2 UL1077 CAN/CSA-C22.2 No. 35
Poles	1 ... 4	1 ... 4
Rated current I_e	A 0.1 ... 45	0.1 ... 45
Rated frequency f	Hz 50 / 60	
Rated insulation voltage U_i acc. to IEC/EN 60664-1	V AC 690	DC 1000
Rated impulse withstand voltage U_{imp} (1.2/50µs)	kV 6	6
Overvoltage category	III	DC 250V: IV DC 500V: III DC 750V: II
Pollution degree	3	3
Suitability for isolation	yes	yes
Data acc. to IEC/EN 60898-1		
Rated operational voltage U_e	V –	–
Rated short-circuit capacity I_{cn}	kA –	–
Service short-circuit capacity I_{cs}	kA –	–
Data acc. to IEC/EN 60947-2		
Rated operational voltage U_e	V AC 400/690	1-pole: DC 250 2-pole: DC 500 3-pole: DC 750 4-pole: DC 750
Rated ultimate short-circuit capacity I_{cu}	kA AC 230/400V (up to 11 A) = 50 kA AC 230/400V (10 ... 45 A) = 30 kA AC 250/440V (up to 11 A) = 30 kA AC 250/440V (10 ... 45 A) = 25 kA AC 3 x 500V (up to 11 A) = 20 kA AC 3 x 500V (10 ... 45 A) = 15 kA AC 400/690V = 6 kA	1-pole: DC 250 = 30 kA 2-pole: DC 500 = 30 kA 3-pole: DC 750 = 30 kA 4-pole: DC 750 = 30 kA
Rated service short-circuit capacity I_{cs}	kA AC 230/400V (up to 11 A) = 30 kA AC 230/400V (10 ... 45 A) = 25 kA AC 250/440V = 22 kA AC 3 x 500V (up to 11 A) = 15 kA AC 3 x 500V (10 ... 45 A) = 11 kA AC 400/690V = 3 kA	1-pole: DC 250 = 30 kA 2-pole: DC 500 = 30 kA 3-pole: DC 750 = 30 kA 4-pole: DC 750 = 30 kA
Data acc. to UL1077 and CSA-C22.2 No. 35		
Rated operational voltage U_e	V 1-pole: AC 240 2- and 3-pole: AC 600V 1-pole: DC 250 2-pole in series: DC 500 3-pole in series: DC 600	1-pole: DC 250 2-pole in series: DC 500 3-pole in series: DC 600
Rated short-circuit breaking capacity I_{cc}	kA AC 240V (up to 11 A) = 30 kA AC 240V (25 ... 45 A) = 18 kA AC 277V (1-pole) = 14 kA AC 450V (3-pole) = 14 kA AC 600V = 6 kA	1-pole: DC 250 = 30 kA 2-pole: DC 500 = 30 kA 3-pole: DC 750 = 30 kA 4-pole: DC 750 = 30 kA

Overview S500

	S500HV	F500 Residual current operated Circuit-Breaker with Overcurrent protection	F500 Residual current operated Circuit-Breaker with Overcurrent protection
Tripping characteristics	K	C, D	K
Standards	IEC/EN 60947-2	IEC/EN 60947-2	IEC/EN 60947-2
Poles	1 ... 3	2 ... 4	2 ... 4
Rated current I _e	A 1 ... 45	10 ... 63	0.2 ... 45
Rated frequency f	Hz 50 / 60	50/60	50/60
Rated insulation voltage U _i acc. to IEC/EN 60664-1	V	AC 1000	AC 690 AC 690
Rated impulse withstand voltage U _{imp} . (1.2/50µs) kV	6	6	6
Overvoltage category	II		
Pollution degree	2	3	3
Suitability for isolation	yes	yes	yes
Data acc. to IEC/EN 60898-1			
Rated operational voltage U _e	V –	–	–
Rated short-circuit capacity I _{cn}	kA –	–	–
Service short-circuit capacity I _{cs}	kA –	–	–
Data acc. to IEC/EN 60947-2			
Rated operational voltage U _e	V AC 580/1000	AC 690	AC 690
Rated ultimate short-circuit capacity I _{cu}	kA AC 580/1000 = 1.5 kA	AC 400 V = 50 kA AC 440 V = 30 kA AC 3 x 500 V = 15 kA AC 690 V = 6 kA	AC 400 V (up to 11 A) = 50 kA AC 400 V (10 ... 45 A) = 30 kA AC 440 V (up to 11 A) = 30 kA AC 440 V (10 ... 45 A) = 25 kA AC 3 x 500 V (up to 11 A) = 20 kA AC 3 x 500 V (10 ... 45 A) = 15 kA AC 690 V = 6 kA
Rated service short-circuit capacity I _{cs}	kA AC 580/1000 = 1.5 kA	AC 400 V = 25 kA AC 440 V = 22 kA AC 3 x 500 V = 11 kA AC 690 V = 3 kA	AC 400 V (up to 11 A) = 30 kA AC 400 V (10 ... 45 A) = 25 kA AC 440 V = 22 kA AC 3 x 500 V (up to 11 A) = 15 kA AC 3 x 500 V (10 ... 45 A) = 11 kA AC 690 V = 3 kA
Data acc. to UL1077 and CSA-C22.2 No. 35			
Rated operational voltage U _e	V –	–	–
Rated short-circuit breaking capacity I _{cc}	kA –	–	–

Applications

The range of applications of the S800 and S500 high performance circuit breakers is extremely varied: from building and marine installations, industry, transport and renewable energies to uninterrupted power supply. The S800 and S500 high performance circuit breakers are reliable switches: rated ultimate short-circuit breaking capacity up to 50 kA, adjust-

able or fixed rated tripping current, current rating up to 125 A, the most varied of characteristics and much more.

The S800 and S500 are flexible, yet at the same time meet the highest safety requirements. See the variety for yourself!



Building installation



Transport



Industry



Renewable energy

New Products

CMS (Current Measurement Sensor) for S800

Simple and flexible assembling

The CMS is a multichannel current measurement system for branch monitoring of alternating (AC) and direct (DC) currents up to 160 A. Various sensor types allow the mounting in every installation environment.

Advantages

- A sensor for all types of current
- Minimal space requirements
- Simple installation
- Always retrofitted and expanded

Overview

PC/ PLC for processing and
visualization of the measurement
values

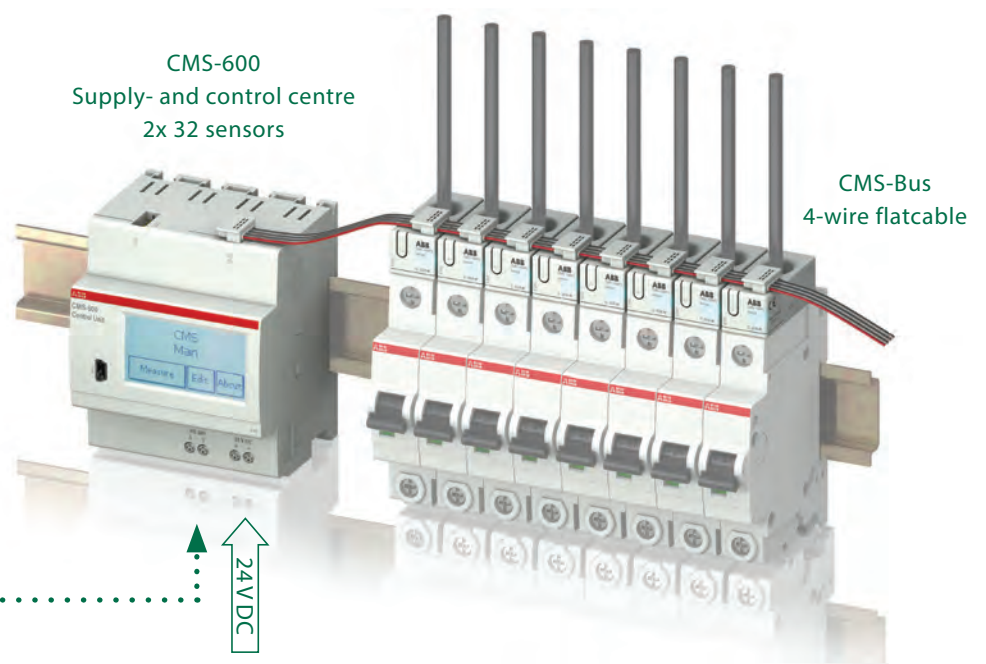
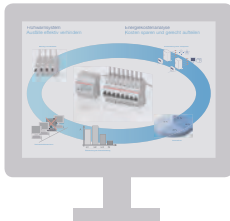

New Products

Pole connector S802-LINK



Circuit breakers used to protect photovoltaic equipment are exposed to high ambient temperatures during operation and they have to withstand high temperatures up to 50 °C or more. When a circuit breaker with rated current of 125 A is used, roughly 50 % of heat generated by the current is dispersed through the conductors or wires which are connected via the terminals to the breaker as well as the incoming and outgoing.

If the incoming conductors or wires, which are located in the upper part of the circuit breaker, are eliminated and replaced by a short wire, in form of an electrical bridge, there is no possibility to take out the heat generated in the circuit breaker and this can result in overheating of the breaker. Due to the high ambient temperatures, the excessive amount of heat generated in circuit breakers can lead to a considerable increase in the combiner's box temperature and this can lead to malfunction i.e. early tripping of the MCB or even overheating the MCB.

The link connector is an evolutionary form of electric connector, which is capable to dissipate the heat generated, and improves significantly the thermal conditions of the application. The pole connector dissipates the heat by natural convection, and because of its dielectric strength it is safe even if it is touched.

Advantages of the pole connector

- Avoid hazardous situation due to high temperatures in demanding applications
- Avoid early tripping of the MCB
- Reduce heat dissipation of the MCBs in the box with significant temperature reduction
- Small dimensions fit in every box
- Rated current range of 50 A and 125 A used in 2-pole and 4-pole-breakers
- Avoid isolation damage by excessive bent of the cable (not following cable manufacturer limits)

Table of content S800

S800S-B	1/2
S800S-C	1/4
S800S-D	1/6
S800S-K	1/8
S803S-KM	1/10
S800S-UCB	1/11
S800S-UCK	1/12
S800N-B	1/13
S800N-C	1/15
S800N-D	1/17
S800C-B	1/19
S800C-C	1/20
S800C-D	1/21
S800C-K	1/22
S800B-B	1/23
S800B-C	1/24
S800B-D	1/25
S800B-K	1/26
S800HV-K	1/27
S800U-K	1/28
S800U-Z	1/29
S804U-UCZ	1/30
S800PV-SP	1/31
S800PV-SD	1/32
S802PV-M-H	1/33
S804U-PVS	1/33
Accessories	1/34

S800S-B Characteristic B

$I_{cu} = 50 \text{ kA}$; with interchangeable cage terminal

1



2CCS413001F0002



I_{cu} [kA]	Rated current [A]	Order details Type Code	Order code	GTIN EAN 7612271	Weight [kg]	Pack. unit
50	6	S801S-B6	2CCS861001R0065	408107	0.24	1
50	8	S801S-B8	2CCS861001R0085	411329	0.24	1
50	10	S801S-B10	2CCS861001R0105	200008	0.24	1
50	13	S801S-B13	2CCS861001R0135	200015	0.24	1
50	16	S801S-B16	2CCS861001R0165	200022	0.24	1
50	20	S801S-B20	2CCS861001R0205	200039	0.24	1
50	25	S801S-B25	2CCS861001R0255	200046	0.24	1
50	32	S801S-B32	2CCS861001R0325	200053	0.24	1
50	40	S801S-B40	2CCS861001R0405	200060	0.24	1
50	50	S801S-B50	2CCS861001R0505	200077	0.24	1
50	63	S801S-B63	2CCS861001R0635	200084	0.24	1
50	80	S801S-B80	2CCS861001R0805	200091	0.24	1
50	100	S801S-B100	2CCS861001R0825	200107	0.24	1
50	125	S801S-B125	2CCS861001R0845	200114	0.24	1



2CCS413002F0002



50	6	S802S-B6	2CCS862001R0065	408114	0.49	1
50	8	S802S-B8	2CCS862001R0085	411336	0.49	1
50	10	S802S-B10	2CCS862001R0105	200121	0.49	1
50	13	S802S-B13	2CCS862001R0135	200138	0.49	1
50	16	S802S-B16	2CCS862001R0165	200145	0.49	1
50	20	S802S-B20	2CCS862001R0205	200152	0.49	1
50	25	S802S-B25	2CCS862001R0255	200169	0.49	1
50	32	S802S-B32	2CCS862001R0325	200176	0.49	1
50	40	S802S-B40	2CCS862001R0405	200183	0.49	1
50	50	S802S-B50	2CCS862001R0505	200190	0.49	1
50	63	S802S-B63	2CCS862001R0635	200206	0.49	1
50	80	S802S-B80	2CCS862001R0805	200213	0.49	1
50	100	S802S-B100	2CCS862001R0825	200220	0.49	1
50	125	S802S-B125	2CCS862001R0845	200237	0.49	1



2CCS413003F0002



50	6	S803S-B6	2CCS863001R0065	408121	0.74	1
50	8	S803S-B8	2CCS863001R0085	411343	0.74	1
50	10	S803S-B10	2CCS863001R0105	200244	0.74	1
50	13	S803S-B13	2CCS863001R0135	200251	0.74	1
50	16	S803S-B16	2CCS863001R0165	200268	0.74	1
50	20	S803S-B20	2CCS863001R0205	200275	0.74	1
50	25	S803S-B25	2CCS863001R0255	200282	0.74	1
50	32	S803S-B32	2CCS863001R0325	200299	0.74	1
50	40	S803S-B40	2CCS863001R0405	200305	0.74	1
50	50	S803S-B50	2CCS863001R0505	200312	0.74	1
50	63	S803S-B63	2CCS863001R0635	200329	0.74	1
50	80	S803S-B80	2CCS863001R0805	200336	0.74	1
50	100	S803S-B100	2CCS863001R0825	200343	0.74	1
50	125	S803S-B125	2CCS863001R0845	200350	0.74	1

S800S-B Characteristic B

$I_{CU} = 50 \text{ kA}$; with interchangeable cage terminal



ZCCS864001R0002



I_{cu} [kA]	Rated current [A]	Order details Type Code	Order code	GTIN EAN 7612271	Weight [kg]	Pack. unit
50	6	S804S-B6	2CCS864001R0065	408138	0.98	1
50	8	S804S-B8	2CCS864001R0085	411350	0.98	1
50	10	S804S-B10	2CCS864001R0105	200367	0.98	1
50	13	S804S-B13	2CCS864001R0135	200374	0.98	1
50	16	S804S-B16	2CCS864001R0165	200381	0.98	1
50	20	S804S-B20	2CCS864001R0205	200398	0.98	1
50	25	S804S-B25	2CCS864001R0255	200404	0.98	1
50	32	S804S-B32	2CCS864001R0325	200411	0.98	1
50	40	S804S-B40	2CCS864001R0405	200428	0.98	1
50	50	S804S-B50	2CCS864001R0505	200435	0.98	1
50	63	S804S-B63	2CCS864001R0635	200442	0.98	1
50	80	S804S-B80	2CCS864001R0805	200459	0.98	1
50	100	S804S-B100	2CCS864001R0825	200466	0.98	1
50	125	S804S-B125	2CCS864001R0845	200473	0.98	1

S800S-C Characteristic C

$I_{cu} = 50 \text{ kA}$; with interchangeable cage terminal

1



2CCS413005F0002



I_{cu} [kA]	Rated current [A]	Order details Type Code	Order code	GTIN EAN 7612271	Weight [kg]	Pack. unit
50	6	S801S-C6	2CCS861001R0064	408145	0.24	1
50	8	S801S-C8	2CCS861001R0084	411367	0.24	1
50	10	S801S-C10	2CCS861001R0104	200480	0.24	1
50	13	S801S-C13	2CCS861001R0134	200497	0.24	1
50	16	S801S-C16	2CCS861001R0164	200503	0.24	1
50	20	S801S-C20	2CCS861001R0204	200510	0.24	1
50	25	S801S-C25	2CCS861001R0254	200527	0.24	1
50	32	S801S-C32	2CCS861001R0324	200534	0.24	1
50	40	S801S-C40	2CCS861001R0404	200541	0.24	1
50	50	S801S-C50	2CCS861001R0504	200558	0.24	1
50	63	S801S-C63	2CCS861001R0634	200565	0.24	1
50	80	S801S-C80	2CCS861001R0804	200572	0.24	1
50	100	S801S-C100	2CCS861001R0824	200589	0.24	1
50	125	S801S-C125	2CCS861001R0844	200596	0.24	1



2CCS413006F0002



50	6	S802S-C6	2CCS862001R0064	408152	0.49	1
50	8	S802S-C8	2CCS862001R0084	411374	0.49	1
50	10	S802S-C10	2CCS862001R0104	200602	0.49	1
50	13	S802S-C13	2CCS862001R0134	200619	0.49	1
50	16	S802S-C16	2CCS862001R0164	200626	0.49	1
50	20	S802S-C20	2CCS862001R0204	200633	0.49	1
50	25	S802S-C25	2CCS862001R0254	200640	0.49	1
50	32	S802S-C32	2CCS862001R0324	200657	0.49	1
50	40	S802S-C40	2CCS862001R0404	200664	0.49	1
50	50	S802S-C50	2CCS862001R0504	200671	0.49	1
50	63	S802S-C63	2CCS862001R0634	200688	0.49	1
50	80	S802S-C80	2CCS862001R0804	200695	0.49	1
50	100	S802S-C100	2CCS862001R0824	200701	0.49	1
50	125	S802S-C125	2CCS862001R0844	200718	0.49	1



2CCS413007F0002



50	6	S803S-C6	2CCS863001R0064	408169	0.74	1
50	8	S803S-C8	2CCS863001R0084	411381	0.74	1
50	10	S803S-C10	2CCS863001R0104	200725	0.74	1
50	13	S803S-C13	2CCS863001R0134	200732	0.74	1
50	16	S803S-C16	2CCS863001R0164	200749	0.74	1
50	20	S803S-C20	2CCS863001R0204	200756	0.74	1
50	25	S803S-C25	2CCS863001R0254	200763	0.74	1
50	32	S803S-C32	2CCS863001R0324	200770	0.74	1
50	40	S803S-C40	2CCS863001R0404	200787	0.74	1
50	50	S803S-C50	2CCS863001R0504	200794	0.74	1
50	63	S803S-C63	2CCS863001R0634	200800	0.74	1
50	80	S803S-C80	2CCS863001R0804	200817	0.74	1
50	100	S803S-C100	2CCS863001R0824	200824	0.74	1
50	125	S803S-C125	2CCS863001R0844	200831	0.74	1

S800S-C Characteristic C

$I_{CU} = 50 \text{ kA}$; with interchangeable cage terminal



2CCS413008F0002



I_{cu} [kA]	Rated current [A]	Order details Type Code	Order code	GTIN EAN 7612271	Weight [kg]	Pack. unit
50	6	S804S-C6	2CCS864001R0064	408176	0.98	1
50	8	S804S-C8	2CCS864001R0084	411398	0.98	1
50	10	S804S-C10	2CCS864001R0104	200848	0.98	1
50	13	S804S-C13	2CCS864001R0134	200855	0.98	1
50	16	S804S-C16	2CCS864001R0164	200862	0.98	1
50	20	S804S-C20	2CCS864001R0204	200879	0.98	1
50	25	S804S-C25	2CCS864001R0254	200886	0.98	1
50	32	S804S-C32	2CCS864001R0324	200893	0.98	1
50	40	S804S-C40	2CCS864001R0404	200909	0.98	1
50	50	S804S-C50	2CCS864001R0504	200916	0.98	1
50	63	S804S-C63	2CCS864001R0634	200923	0.98	1
50	80	S804S-C80	2CCS864001R0804	200930	0.98	1
50	100	S804S-C100	2CCS864001R0824	200947	0.98	1
50	125	S804S-C125	2CCS864001R0844	200954	0.98	1

S800S-D Characteristic D

$I_{cu} = 50 \text{ kA}$; with interchangeable cage terminal

1



2CCS413009F0002



I_{cu} [kA]	Rated current [A]	Order details Type Code	Order code	GTIN EAN 7612271	Weight [kg]	Pack. unit
50	6	S801S-D6	2CCS861001R0061	408183	0.24	1
50	8	S801S-D8	2CCS861001R0081	411404	0.24	1
50	10	S801S-D10	2CCS861001R0101	200961	0.24	1
50	13	S801S-D13	2CCS861001R0131	200978	0.24	1
50	16	S801S-D16	2CCS861001R0161	200985	0.24	1
50	20	S801S-D20	2CCS861001R0201	200992	0.24	1
50	25	S801S-D25	2CCS861001R0251	201005	0.24	1
50	32	S801S-D32	2CCS861001R0321	201012	0.24	1
50	40	S801S-D40	2CCS861001R0401	201029	0.24	1
50	50	S801S-D50	2CCS861001R0501	201036	0.24	1
50	63	S801S-D63	2CCS861001R0631	201043	0.24	1
50	80	S801S-D80	2CCS861001R0801	201050	0.24	1
50	100	S801S-D100	2CCS861001R0821	201067	0.24	1
50	125	S801S-D125	2CCS861001R0841	201074	0.24	1



2CCS413010F0002



50	6	S802S-D6	2CCS862001R0061	408190	0.49	1
50	8	S802S-D8	2CCS862001R0081	411411	0.49	1
50	10	S802S-D10	2CCS862001R0101	201081	0.49	1
50	13	S802S-D13	2CCS862001R0131	201098	0.49	1
50	16	S802S-D16	2CCS862001R0161	201104	0.49	1
50	20	S802S-D20	2CCS862001R0201	201111	0.49	1
50	25	S802S-D25	2CCS862001R0251	201128	0.49	1
50	32	S802S-D32	2CCS862001R0321	201135	0.49	1
50	40	S802S-D40	2CCS862001R0401	201142	0.49	1
50	50	S802S-D50	2CCS862001R0501	201159	0.49	1
50	63	S802S-D63	2CCS862001R0631	201166	0.49	1
50	80	S802S-D80	2CCS862001R0801	201173	0.49	1
50	100	S802S-D100	2CCS862001R0821	201180	0.49	1
50	125	S802S-D125	2CCS862001R0841	201197	0.49	1



2CCS413011F0002



50	6	S803S-D6	2CCS863001R0061	408206	0.74	1
50	8	S803S-D8	2CCS863001R0081	411428	0.74	1
50	10	S803S-D10	2CCS863001R0101	201203	0.74	1
50	13	S803S-D13	2CCS863001R0131	201210	0.74	1
50	16	S803S-D16	2CCS863001R0161	201227	0.74	1
50	20	S803S-D20	2CCS863001R0201	201234	0.74	1
50	25	S803S-D25	2CCS863001R0251	201241	0.74	1
50	32	S803S-D32	2CCS863001R0321	201258	0.74	1
50	40	S803S-D40	2CCS863001R0401	201265	0.74	1
50	50	S803S-D50	2CCS863001R0501	201272	0.74	1
50	63	S803S-D63	2CCS863001R0631	201289	0.74	1
50	80	S803S-D80	2CCS863001R0801	201296	0.74	1
50	100	S803S-D100	2CCS863001R0821	201302	0.74	1
50	125	S803S-D125	2CCS863001R0841	201319	0.74	1

S800S-D Characteristic D

$I_{CU} = 50 \text{ kA}$; with interchangeable cage terminal



2CCS41307R0002

I_{cu} [kA]	Rated current [A]	Order details Type Code	Order code	GTIN EAN 7612271	Weight [kg]	Pack. unit
50	6	S804S-D6	2CCS864001R0061	408213	0.98	1
50	8	S804S-D8	2CCS864001R0081	411435	0.98	1
50	10	S804S-D10	2CCS864001R0101	201326	0.98	1
50	13	S804S-D13	2CCS864001R0131	201333	0.98	1
50	16	S804S-D16	2CCS864001R0161	201340	0.98	1
50	20	S804S-D20	2CCS864001R0201	201357	0.98	1
50	25	S804S-D25	2CCS864001R0251	201364	0.98	1
50	32	S804S-D32	2CCS864001R0321	201371	0.98	1
50	40	S804S-D40	2CCS864001R0401	201388	0.98	1
50	50	S804S-D50	2CCS864001R0501	201395	0.98	1
50	63	S804S-D63	2CCS864001R0631	201401	0.98	1
50	80	S804S-D80	2CCS864001R0801	201418	0.98	1
50	100	S804S-D100	2CCS864001R0821	201425	0.98	1
50	125	S804S-D125	2CCS864001R0841	201432	0.98	1

S800S-K Characteristic K

$I_{cu} = 50 \text{ kA}$; with interchangeable cage terminal

1



2CCS413013F0001



I_{cu} [kA]	Rated current [A]	Order details Type Code	Order code	GTIN EAN 7612271	Weight [kg]	Pack. unit
50	6	S801S-K6	2CCS861001R0067	408220	0.24	1
50	8	S801S-K8	2CCS861001R0407	411442	0.24	1
50	10	S801S-K10	2CCS861001R0427	201449	0.24	1
50	13	S801S-K13	2CCS861001R0447	201456	0.24	1
50	16	S801S-K16	2CCS861001R0467	201463	0.24	1
50	20	S801S-K20	2CCS861001R0487	201470	0.24	1
50	25	S801S-K25	2CCS861001R0517	201487	0.24	1
50	32	S801S-K32	2CCS861001R0537	201494	0.24	1
50	40	S801S-K40	2CCS861001R0557	201500	0.24	1
50	50	S801S-K50	2CCS861001R0577	201517	0.24	1
50	63	S801S-K63	2CCS861001R0597	201524	0.24	1
50	80	S801S-K80	2CCS861001R0627	201531	0.24	1
50	100	S801S-K100	2CCS861001R0637	201548	0.24	1
50	125	S801S-K125	2CCS861001R0647	201555	0.24	1



2CCS413014F0001



50	6	S802S-K6	2CCS862001R0067	408237	0.49	1
50	8	S802S-K8	2CCS862001R0407	411459	0.49	1
50	10	S802S-K10	2CCS862001R0427	201562	0.49	1
50	13	S802S-K13	2CCS862001R0447	201579	0.49	1
50	16	S802S-K16	2CCS862001R0467	201586	0.49	1
50	20	S802S-K20	2CCS862001R0487	201593	0.49	1
50	25	S802S-K25	2CCS862001R0517	201609	0.49	1
50	32	S802S-K32	2CCS862001R0537	201616	0.49	1
50	40	S802S-K40	2CCS862001R0557	201623	0.49	1
50	50	S802S-K50	2CCS862001R0577	201630	0.49	1
50	63	S802S-K63	2CCS862001R0597	201647	0.49	1
50	80	S802S-K80	2CCS862001R0627	201654	0.49	1
50	100	S802S-K100	2CCS862001R0637	201661	0.49	1
50	125	S802S-K125	2CCS862001R0647	201678	0.49	1



2CCS413015F0001



50	6	S803S-K6	2CCS863001R0067	408244	0.74	1
50	8	S803S-K8	2CCS863001R0407	411466	0.74	1
50	10	S803S-K10	2CCS863001R0427	201685	0.74	1
50	13	S803S-K13	2CCS863001R0447	201692	0.74	1
50	16	S803S-K16	2CCS863001R0467	201708	0.74	1
50	20	S803S-K20	2CCS863001R0487	201715	0.74	1
50	25	S803S-K25	2CCS863001R0517	201722	0.74	1
50	32	S803S-K32	2CCS863001R0537	201739	0.74	1
50	40	S803S-K40	2CCS863001R0557	201746	0.74	1
50	50	S803S-K50	2CCS863001R0577	201753	0.74	1
50	63	aS803S-K63	2CCS863001R0597	201760	0.74	1
50	80	S803S-K80	2CCS863001R0627	201777	0.74	1
50	100	S803S-K100	2CCS863001R0637	201784	0.74	1
50	125	S803S-K125	2CCS863001R0647	201791	0.74	1

S800S-K Characteristic K

$I_{CU} = 50 \text{ kA}$; with interchangeable cage terminal



2CCS41301R06001



I_{cu} [kA]	Rated current [A]	Order details Type Code	Order code	GTIN EAN 7612271	Weight [kg]	Pack. unit
50	6	S804S-K6	2CCS864001R0067	408251	0.98	1
50	8	S804S-K8	2CCS864001R0407	411473	0.98	1
50	10	S804S-K10	2CCS864001R0427	201807	0.98	1
50	13	S804S-K13	2CCS864001R0447	201814	0.98	1
50	16	S804S-K16	2CCS864001R0467	201821	0.98	1
50	20	S804S-K20	2CCS864001R0487	201838	0.98	1
50	25	S804S-K25	2CCS864001R0517	201845	0.98	1
50	32	S804S-K32	2CCS864001R0537	201852	0.98	1
50	40	S804S-K40	2CCS864001R0557	201869	0.98	1
50	50	S804S-K50	2CCS864001R0577	201876	0.98	1
50	63	S804S-K63	2CCS864001R0597	201883	0.98	1
50	80	S804S-K80	2CCS864001R0627	201890	0.98	1
50	100	S804S-K100	2CCS864001R0637	201906	0.98	1
50	125	S804S-K125	2CCS864001R0647	201913	0.98	1

S803S-KM Characteristic KM*

$I_{cu} = 50 \text{ kA}$; with interchangeable cage terminal

1



2CCC413017F0001



I_{cu} [kA]	Rated current [A]	Order details Type Code	Order code	GTIN EAN 76122712	Weight [kg]	Pack. unit
50	10	S803S-KM10	2CCF019559R0001	41104	0.735	1
50	16	S803S-KM16	2CCF019569R0001	41111	0.735	1
50	20	S803S-KM20	2CCS863001R0486	02194	0.74	1
50	25	S803S-KM25	2CCS863001R0516	02200	0.74	1
50	32	S803S-KM32	2CCS863001R0536	02217	0.74	1
50	40	S803S-KM40	2CCS863001R0556	02224	0.74	1
50	50	S803S-KM50	2CCS863001R0576	02231	0.74	1
50	63	S803S-KM63	2CCS863001R0596	02248	0.74	1
50	80	S803S-KM80	2CCS863001R0626	02255	0.74	1

*M stands for magnetic tripping only

S800S-UCB Characteristic B*

$I_{CU} = 50 \text{ kA}$; with interchangeable cage terminal



ZCCCA1323F0001



ZCCCA1324F0001



ZCCCA1325F0001



ZCCCA1326F0001



I_{cu} [kA]	Rated current [A]	Order details Type Code	Order code	GTIN EAN 76122712	Weight [kg]	Pack. unit
50	10	S801S-UCB10	2CCS861001R1105	02842	0.24	1
50	13	S801S-UCB13	2CCS861001R1135	02859	0.24	1
50	16	S801S-UCB16	2CCS861001R1165	02866	0.24	1
50	20	S801S-UCB20	2CCS861001R1205	02873	0.24	1
50	25	S801S-UCB25	2CCS861001R1255	02880	0.24	1
50	32	S801S-UCB32	2CCS861001R1325	02897	0.24	1
50	40	S801S-UCB40	2CCS861001R1405	02903	0.24	1
50	50	S801S-UCB50	2CCS861001R1505	02910	0.24	1
50	63	S801S-UCB63	2CCS861001R1635	02927	0.24	1
50	80	S801S-UCB80	2CCS861001R1805	02934	0.24	1
50	100	S801S-UCB100	2CCS861001R1825	02941	0.24	1
50	125	S801S-UCB125	2CCS861001R1845	02958	0.24	1
50	10	S802S-UCB10	2CCS862001R1105	02965	0.49	1
50	13	S802S-UCB13	2CCS862001R1135	02972	0.49	1
50	16	S802S-UCB16	2CCS862001R1165	02989	0.49	1
50	20	S802S-UCB20	2CCS862001R1205	02996	0.49	1
50	25	S802S-UCB25	2CCS862001R1255	03009	0.49	1
50	32	S802S-UCB32	2CCS862001R1325	03016	0.49	1
50	40	S802S-UCB40	2CCS862001R1405	03023	0.49	1
50	50	S802S-UCB50	2CCS862001R1505	03030	0.49	1
50	63	S802S-UCB63	2CCS862001R1635	03047	0.49	1
50	80	S802S-UCB80	2CCS862001R1805	03054	0.49	1
50	100	S802S-UCB100	2CCS862001R1825	03061	0.49	1
50	125	S802S-UCB125	2CCS862001R1845	03078	0.49	1
50	10	S803S-UCB10	2CCS863001R1105	03085	0.74	1
50	13	S803S-UCB13	2CCS863001R1135	03092	0.74	1
50	16	S803S-UCB16	2CCS863001R1165	03108	0.74	1
50	20	S803S-UCB20	2CCS863001R1205	03115	0.74	1
50	25	S803S-UCB25	2CCS863001R1255	03122	0.74	1
50	32	S803S-UCB32	2CCS863001R1325	03139	0.74	1
50	40	S803S-UCB40	2CCS863001R1405	03146	0.74	1
50	50	S803S-UCB50	2CCS863001R1505	03153	0.74	1
50	63	S803S-UCB63	2CCS863001R1635	03160	0.74	1
50	80	S803S-UCB80	2CCS863001R1805	03177	0.74	1
50	100	S803S-UCB100	2CCS863001R1825	03184	0.74	1
50	125	S803S-UCB125	2CCS863001R1845	03191	0.74	1
50	10	S804S-UCB10	2CCS864001R1105	03207	0.98	1
50	13	S804S-UCB13	2CCS864001R1135	03214	0.98	1
50	16	S804S-UCB16	2CCS864001R1165	03221	0.98	1
50	20	S804S-UCB20	2CCS864001R1205	03238	0.98	1
50	25	S804S-UCB25	2CCS864001R1255	03245	0.98	1
50	32	S804S-UCB32	2CCS864001R1325	03252	0.98	1
50	40	S804S-UCB40	2CCS864001R1405	03269	0.98	1
50	50	S804S-UCB50	2CCS864001R1505	03276	0.98	1
50	63	S804S-UCB63	2CCS864001R1635	03283	0.98	1
50	80	S804S-UCB80	2CCS864001R1805	03290	0.98	1
50	100	S804S-UCB100	2CCS864001R1825	03306	0.98	1
50	125	S804S-UCB125	2CCS864001R1845	03313	0.98	1

*For DC applications

S800S-UCK Characteristic K*

$I_{cu} = 50 \text{ kA}$; with interchangeable cage terminal

1



2CCCA13227R001



2CCCA13228R001



2CCCA13229R001



2CCCA13230R001



I_{cu} [kA]	Rated current [A]	Order details Type Code	Order code	GTIN EAN 76122712	Weight [kg]	Pack. unit
50	10	S801S-UCK10	2CCS861001R1427	03320	0.24	1
50	13	S801S-UCK13	2CCS861001R1447	03337	0.24	1
50	16	S801S-UCK16	2CCS861001R1467	03344	0.24	1
50	20	S801S-UCK20	2CCS861001R1487	03351	0.24	1
50	25	S801S-UCK25	2CCS861001R1517	03368	0.24	1
50	32	S801S-UCK32	2CCS861001R1537	03375	0.24	1
50	40	S801S-UCK40	2CCS861001R1557	03382	0.24	1
50	50	S801S-UCK50	2CCS861001R1577	03399	0.24	1
50	63	S801S-UCK63	2CCS861001R1597	03405	0.24	1
50	80	S801S-UCK80	2CCS861001R1627	03412	0.24	1
50	100	S801S-UCK100	2CCS861001R1637	03429	0.24	1
50	125	S801S-UCK125	2CCS861001R1647	03436	0.24	1
50	10	S802S-UCK10	2CCS862001R1427	03443	0.49	1
50	13	S802S-UCK13	2CCS862001R1447	03450	0.49	1
50	16	S802S-UCK16	2CCS862001R1467	03467	0.49	1
50	20	S802S-UCK20	2CCS862001R1487	03474	0.49	1
50	25	S802S-UCK25	2CCS862001R1517	03481	0.49	1
50	32	S802S-UCK32	2CCS862001R1537	03498	0.49	1
50	40	S802S-UCK40	2CCS862001R1557	03504	0.49	1
50	50	S802S-UCK50	2CCS862001R1577	03511	0.49	1
50	63	S802S-UCK63	2CCS862001R1597	03528	0.49	1
50	80	S802S-UCK80	2CCS862001R1627	03535	0.49	1
50	100	S802S-UCK100	2CCS862001R1637	03542	0.49	1
50	125	S802S-UCK125	2CCS862001R1647	03559	0.49	1
50	10	S803S-UCK10	2CCS863001R1427	03566	0.74	1
50	13	S803S-UCK13	2CCS863001R1447	03573	0.74	1
50	16	S803S-UCK16	2CCS863001R1467	03580	0.74	1
50	20	S803S-UCK20	2CCS863001R1487	03597	0.74	1
50	25	S803S-UCK25	2CCS863001R1517	03603	0.74	1
50	32	S803S-UCK32	2CCS863001R1537	03610	0.74	1
50	40	S803S-UCK40	2CCS863001R1557	03627	0.74	1
50	50	S803S-UCK50	2CCS863001R1577	03634	0.74	1
50	63	S803S-UCK63	2CCS863001R1597	03641	0.74	1
50	80	S803S-UCK80	2CCS863001R1627	03658	0.74	1
50	100	S803S-UCK100	2CCS863001R1637	03665	0.74	1
50	125	S803S-UCK125	2CCS863001R1647	03672	0.74	1
50	10	S804S-UCK10	2CCS864001R1427	03689	0.98	1
50	13	S804S-UCK13	2CCS864001R1447	03696	0.98	1
50	16	S804S-UCK16	2CCS864001R1467	03702	0.98	1
50	20	S804S-UCK20	2CCS864001R1487	03719	0.98	1
50	25	S804S-UCK25	2CCS864001R1517	03726	0.98	1
50	32	S804S-UCK32	2CCS864001R1537	03733	0.98	1
50	40	S804S-UCK40	2CCS864001R1557	03740	0.98	1
50	50	S804S-UCK50	2CCS864001R1577	03757	0.98	1
50	63	S804S-UCK63	2CCS864001R1597	03764	0.98	1
50	80	S804S-UCK80	2CCS864001R1627	03771	0.98	1
50	100	S804S-UCK100	2CCS864001R1637	03788	0.98	1
50	125	S804S-UCK125	2CCS864001R1647	03795	0.98	1

*For DC applications

S800N-B Characteristic B

$I_{CU} = 36 \text{ kA}$; with interchangeable cage terminal



2CCS413029F0001



I_{cu} [kA]	Rated current [A]	Order details Type Code	Order code	GTIN EAN 7612271	Weight [kg]	Pack. unit
36	6	S801N-B6	2CCS891001R0065	408428	0.24	1
36	8	S801N-B8	2CCS891001R0085	411640	0.24	1
36	10	S801N-B10	2CCS891001R0105	203801	0.24	1
36	13	S801N-B13	2CCS891001R0135	203818	0.24	1
36	16	S801N-B16	2CCS891001R0165	203825	0.24	1
36	20	S801N-B20	2CCS891001R0205	203832	0.24	1
36	25	S801N-B25	2CCS891001R0255	203849	0.24	1
36	32	S801N-B32	2CCS891001R0325	203856	0.24	1
36	40	S801N-B40	2CCS891001R0405	203863	0.24	1
36	50	S801N-B50	2CCS891001R0505	203870	0.24	1
36	63	S801N-B63	2CCS891001R0635	203887	0.24	1
36	80	S801N-B80	2CCS891001R0805	203894	0.24	1
36	100	S801N-B100	2CCS891001R0825	203900	0.24	1
36	125	S801N-B125	2CCS891001R0845	203917	0.24	1



2CCS413027F0001



36	6	S802N-B6	2CCS892001R0065	408435	0.48	1
36	8	S802N-B8	2CCS892001R0085	411657	0.48	1
36	10	S802N-B10	2CCS892001R0105	203924	0.48	1
36	13	S802N-B13	2CCS892001R0135	203931	0.48	1
36	16	S802N-B16	2CCS892001R0165	203948	0.48	1
36	20	S802N-B20	2CCS892001R0205	203955	0.48	1
36	25	S802N-B25	2CCS892001R0255	203962	0.48	1
36	32	S802N-B32	2CCS892001R0325	203979	0.48	1
36	40	S802N-B40	2CCS892001R0405	203986	0.48	1
36	50	S802N-B50	2CCS892001R0505	203993	0.48	1
36	63	S802N-B63	2CCS892001R0635	204006	0.48	1
36	80	S802N-B80	2CCS892001R0805	204013	0.48	1
36	100	S802N-B100	2CCS892001R0825	204020	0.48	1
36	125	S802N-B125	2CCS892001R0845	204037	0.48	1



2CCS413028F0001



36	6	S803N-B6	2CCS893001R0065	408442	0.72	1
36	8	S803N-B8	2CCS893001R0085	411664	0.72	1
36	10	S803N-B10	2CCS893001R0105	204044	0.72	1
36	13	S803N-B13	2CCS893001R0135	204051	0.72	1
36	16	S803N-B16	2CCS893001R0165	204068	0.72	1
36	20	S803N-B20	2CCS893001R0205	204075	0.72	1
36	25	S803N-B25	2CCS893001R0255	204082	0.72	1
36	32	S803N-B32	2CCS893001R0325	204099	0.72	1
36	40	S803N-B40	2CCS893001R0405	204105	0.72	1
36	50	S803N-B50	2CCS893001R0505	204112	0.72	1
36	63	S803N-B63	2CCS893001R0635	204129	0.72	1
36	80	S803N-B80	2CCS893001R0805	204136	0.72	1
36	100	S803N-B100	2CCS893001R0825	204143	0.72	1
36	125	S803N-B125	2CCS893001R0845	204150	0.72	1

S800N-B Characteristic B

$I_{cu} = 36 \text{ kA}$; with interchangeable cage terminal

1



2CCC413029F0001



I_{cu} [kA]	Rated current [A]	Order details Type Code	Order code	GTIN EAN 7612271	Weight [kg]	Pack. unit
36	6	S804N-B6	2CCS894001R0065	408459	0.96	1
36	8	S804N-B8	2CCS894001R0085	411671	0.96	1
36	10	S804N-B10	2CCS894001R0105	204167	0.96	1
36	13	S804N-B13	2CCS894001R0135	204174	0.96	1
36	16	S804N-B16	2CCS894001R0165	204181	0.96	1
36	20	S804N-B20	2CCS894001R0205	204198	0.96	1
36	25	S804N-B25	2CCS894001R0255	204204	0.96	1
36	32	S804N-B32	2CCS894001R0325	204211	0.96	1
36	40	S804N-B40	2CCS894001R0405	204228	0.96	1
36	50	S804N-B50	2CCS894001R0505	204235	0.96	1
36	63	S804N-B63	2CCS894001R0635	204242	0.96	1
36	80	S804N-B80	2CCS894001R0805	204259	0.96	1
36	100	S804N-B100	2CCS894001R0825	204266	0.96	1
36	125	S804N-B125	2CCS894001R0845	204273	0.96	1

S800N-C Characteristic C

$I_{CU} = 36 \text{ kA}$; with interchangeable cage terminal



2CCS891001R0001



I_{cu} [kA]	Rated current [A]	Order details Type Code	Order code	GTIN EAN 7612271	Weight [kg]	Pack. unit
36	6	S801N-C6	2CCS891001R0064	408466	0.24	1
36	8	S801N-C8	2CCS891001R0084	411688	0.24	1
36	10	S801N-C10	2CCS891001R0104	204280	0.24	1
36	13	S801N-C13	2CCS891001R0134	204297	0.24	1
36	16	S801N-C16	2CCS891001R0164	204303	0.24	1
36	20	S801N-C20	2CCS891001R0204	204310	0.24	1
36	25	S801N-C25	2CCS891001R0254	204327	0.24	1
36	32	S801N-C32	2CCS891001R0324	204334	0.24	1
36	40	S801N-C40	2CCS891001R0404	204341	0.24	1
36	50	S801N-C50	2CCS891001R0504	204358	0.24	1
36	63	S801N-C63	2CCS891001R0634	204365	0.24	1
36	80	S801N-C80	2CCS891001R0804	204372	0.24	1
36	100	S801N-C100	2CCS891001R0824	204389	0.24	1
36	125	S801N-C125	2CCS891001R0844	204396	0.24	1



2CCS892001R0001



36	6	S802N-C6	2CCS892001R0064	408473	0.48	1
36	8	S802N-C8	2CCS892001R0084	411695	0.48	1
36	10	S802N-C10	2CCS892001R0104	204402	0.48	1
36	13	S802N-C13	2CCS892001R0134	204419	0.48	1
36	16	S802N-C16	2CCS892001R0164	204426	0.48	1
36	20	S802N-C20	2CCS892001R0204	204433	0.48	1
36	25	S802N-C25	2CCS892001R0254	204440	0.48	1
36	32	S802N-C32	2CCS892001R0324	204457	0.48	1
36	40	S802N-C40	2CCS892001R0404	204464	0.48	1
36	50	S802N-C50	2CCS892001R0504	204471	0.48	1
36	63	S802N-C63	2CCS892001R0634	204488	0.48	1
36	80	S802N-C80	2CCS892001R0804	204495	0.48	1
36	100	S802N-C100	2CCS892001R0824	204501	0.48	1
36	125	S802N-C125	2CCS892001R0844	204518	0.48	1



2CCS893001R0001



36	6	S803N-C6	2CCS893001R0064	408480	0.72	1
36	8	S803N-C8	2CCS893001R0084	411701	0.72	1
36	10	S803N-C10	2CCS893001R0104	204525	0.72	1
36	13	S803N-C13	2CCS893001R0134	204532	0.72	1
36	16	S803N-C16	2CCS893001R0164	204549	0.72	1
36	20	S803N-C20	2CCS893001R0204	204556	0.72	1
36	25	S803N-C25	2CCS893001R0254	204563	0.72	1
36	32	S803N-C32	2CCS893001R0324	204570	0.72	1
36	40	S803N-C40	2CCS893001R0404	204587	0.72	1
36	50	S803N-C50	2CCS893001R0504	204594	0.72	1
36	63	S803N-C63	2CCS893001R0634	204600	0.72	1
36	80	S803N-C80	2CCS893001R0804	204617	0.72	1
36	100	S803N-C100	2CCS893001R0824	204624	0.72	1
36	125	S803N-C125	2CCS893001R0844	204631	0.72	1

S800N-C Characteristic C

$I_{cu} = 36 \text{ kA}$; with interchangeable cage terminal

1



2CCS413033R0001



I_{cu} [kA]	Rated current [A]	Order details Type Code	Order code	GTIN EAN 7612271	Weight [kg]	Pack. unit
36	6	S804N-C6	2CCS894001R0064	408497	0.96	1
36	8	S804N-C8	2CCS894001R0084	411718	0.96	1
36	10	S804N-C10	2CCS894001R0104	204648	0.96	1
36	13	S804N-C13	2CCS894001R0134	204655	0.96	1
36	16	S804N-C16	2CCS894001R0164	204662	0.96	1
36	20	S804N-C20	2CCS894001R0204	204679	0.96	1
36	25	S804N-C25	2CCS894001R0254	204686	0.96	1
36	32	S804N-C32	2CCS894001R0324	204693	0.96	1
36	40	S804N-C40	2CCS894001R0404	204709	0.96	1
36	50	S804N-C50	2CCS894001R0504	204716	0.96	1
36	63	S804N-C63	2CCS894001R0634	204723	0.96	1
36	80	S804N-C80	2CCS894001R0804	204730	0.96	1
36	100	S804N-C100	2CCS894001R0824	204747	0.96	1
36	125	S804N-C125	2CCS894001R0844	204754	0.96	1

S800N-D Characteristic D

$I_{CU} = 36 \text{ kA}$; with interchangeable cage terminal



2CCS413034R0001



I_{cu} [kA]	Rated current [A]	Order details Type Code	Order code	GTIN EAN 7612271	Weight [kg]	Pack. unit
36	6	S801N-D6	2CCS891001R0061	408503	0.24	1
36	8	S801N-D8	2CCS891001R0081	411725	0.24	1
36	10	S801N-D10	2CCS891001R0101	204761	0.24	1
36	13	S801N-D13	2CCS891001R0131	204778	0.24	1
36	16	S801N-D16	2CCS891001R0161	204785	0.24	1
36	20	S801N-D20	2CCS891001R0201	204792	0.24	1
36	25	S801N-D25	2CCS891001R0251	204808	0.24	1
36	32	S801N-D32	2CCS891001R0321	204815	0.24	1
36	40	S801N-D40	2CCS891001R0401	204822	0.24	1
36	50	S801N-D50	2CCS891001R0501	204839	0.24	1
36	63	S801N-D63	2CCS891001R0631	204846	0.24	1
36	80	S801N-D80	2CCS891001R0801	204853	0.24	1
36	100	S801N-D100	2CCS891001R0821	204860	0.24	1
36	125	S801N-D125	2CCS891001R0841	204877	0.24	1



2CCS413035R0001



36	6	S802N-D6	2CCS892001R0061	408510	0.49	1
36	8	S802N-D8	2CCS892001R0081	411732	0.49	1
36	10	S802N-D10	2CCS892001R0101	204884	0.49	1
36	13	S802N-D13	2CCS892001R0131	204891	0.49	1
36	16	S802N-D16	2CCS892001R0161	204907	0.49	1
36	20	S802N-D20	2CCS892001R0201	204914	0.49	1
36	25	S802N-D25	2CCS892001R0251	204921	0.49	1
36	32	S802N-D32	2CCS892001R0321	204938	0.49	1
36	40	S802N-D40	2CCS892001R0401	204945	0.49	1
36	50	S802N-D50	2CCS892001R0501	204952	0.49	1
36	63	S802N-D63	2CCS892001R0631	204969	0.49	1
36	80	S802N-D80	2CCS892001R0801	204976	0.49	1
36	100	S802N-D100	2CCS892001R0821	204983	0.49	1
36	125	S802N-D125	2CCS892001R0841	204990	0.49	1



2CCS413036R0001



36	6	S803N-D6	2CCS893001R0061	408527	0.74	1
36	8	S803N-D8	2CCS893001R0081	411749	0.74	1
36	10	S803N-D10	2CCS893001R0101	205003	0.74	1
36	13	S803N-D13	2CCS893001R0131	205010	0.74	1
36	16	S803N-D16	2CCS893001R0161	205027	0.74	1
36	20	S803N-D20	2CCS893001R0201	205034	0.74	1
36	25	S803N-D25	2CCS893001R0251	205041	0.74	1
36	32	S803N-D32	2CCS893001R0321	205058	0.74	1
36	40	S803N-D40	2CCS893001R0401	205065	0.74	1
36	50	S803N-D50	2CCS893001R0501	205072	0.74	1
36	63	S803N-D63	2CCS893001R0631	205089	0.74	1
36	80	S803N-D80	2CCS893001R0801	205096	0.74	1
36	100	S803N-D100	2CCS893001R0821	205102	0.74	1
36	125	S803N-D125	2CCS893001R0841	205119	0.74	1

S800N-D Characteristic D

$I_{cu} = 36 \text{ kA}$; with interchangeable cage terminal

1



ZCCS894001R0061



I_{cu} [kA]	Rated current [A]	Order details Type Code	Order code	GTIN EAN 7612271	Weight [kg]	Pack. unit
36	6	S804N-D6	2CCS894001R0061	408534	0.98	1
36	8	S804N-D8	2CCS894001R0081	411756	0.98	1
36	10	S804N-D10	2CCS894001R0101	205126	0.98	1
36	13	S804N-D13	2CCS894001R0131	205133	0.98	1
36	16	S804N-D16	2CCS894001R0161	205140	0.98	1
36	20	S804N-D20	2CCS894001R0201	205157	0.98	1
36	25	S804N-D25	2CCS894001R0251	205164	0.98	1
36	32	S804N-D32	2CCS894001R0321	205171	0.98	1
36	40	S804N-D40	2CCS894001R0401	205188	0.98	1
36	50	S804N-D50	2CCS894001R0501	205195	0.98	1
36	63	S804N-D63	2CCS894001R0631	205201	0.98	1
36	80	S804N-D80	2CCS894001R0801	205218	0.98	1
36	100	S804N-D100	2CCS894001R0821	205225	0.98	1
36	125	S804N-D125	2CCS894001R0841	205232	0.98	1

S800C-B Characteristic B

$I_{CU} = 25 \text{ kA}$; with interchangeable cage terminal



ZCC41326ZF001



ZCC413263F001



ZCC413264F001



ZCC413265F001

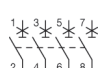

I_{cu} [kA]	Rated current [A]	Order details Type Code	Order code	GTIN EAN 76122712	Weight [kg]	Pack. unit
25	10	S801C-B10	2CCS881001R0105	12087	0.25	1
25	13	S801C-B13	2CCS881001R0135	12247	0.25	1
25	16	S801C-B16	2CCS881001R0165	12407	0.25	1
25	20	S801C-B20	2CCS881001R0205	12568	0.25	1
25	25	S801C-B25	2CCS881001R0255	12728	0.25	1
25	32	S801C-B32	2CCS881001R0325	12889	0.25	1
25	40	S801C-B40	2CCS881001R0405	13046	0.25	1
25	50	S801C-B50	2CCS881001R0505	13206	0.25	1
25	63	S801C-B63	2CCS881001R0635	13367	0.25	1
25	80	S801C-B80	2CCS881001R0805	13527	0.25	1
25	100	S801C-B100	2CCS881001R0825	13688	0.25	1
25	125	S801C-B125	2CCS881001R0845	13848	0.25	1
25	10	S802C-B10	2CCS882001R0105	12094	0.49	1
25	13	S802C-B13	2CCS882001R0135	12254	0.49	1
25	16	S802C-B16	2CCS882001R0165	12414	0.49	1
25	20	S802C-B20	2CCS882001R0205	12575	0.49	1
25	25	S802C-B25	2CCS882001R0255	12735	0.49	1
25	32	S802C-B32	2CCS882001R0325	12896	0.49	1
25	40	S802C-B40	2CCS882001R0405	13053	0.49	1
25	50	S802C-B50	2CCS882001R0505	13213	0.49	1
25	63	S802C-B63	2CCS882001R0635	13374	0.49	1
25	80	S802C-B80	2CCS882001R0805	13534	0.49	1
25	100	S802C-B100	2CCS882001R0825	13695	0.49	1
25	125	S802C-B125	2CCS882001R0845	13855	0.49	1
25	10	S803C-B10	2CCS883001R0105	12100	0.74	1
25	13	S803C-B13	2CCS883001R0135	12261	0.74	1
25	16	S803C-B16	2CCS883001R0165	12421	0.74	1
25	20	S803C-B20	2CCS883001R0205	12582	0.74	1
25	25	S803C-B25	2CCS883001R0255	12742	0.74	1
25	32	S803C-B32	2CCS883001R0325	12902	0.74	1
25	40	S803C-B40	2CCS883001R0405	13060	0.74	1
25	50	S803C-B50	2CCS883001R0505	13220	0.74	1
25	63	S803C-B63	2CCS883001R0635	13381	0.74	1
25	80	S803C-B80	2CCS883001R0805	13541	0.74	1
25	100	S803C-B100	2CCS883001R0825	13701	0.74	1
25	125	S803C-B125	2CCS883001R0845	13862	0.74	1
25	10	S804C-B10	2CCS884001R0105	12117	0.98	1
25	13	S804C-B13	2CCS884001R0135	12278	0.98	1
25	16	S804C-B16	2CCS884001R0165	12438	0.98	1
25	20	S804C-B20	2CCS884001R0205	12599	0.98	1
25	25	S804C-B25	2CCS884001R0255	12759	0.98	1
25	32	S804C-B32	2CCS884001R0325	12919	0.98	1
25	40	S804C-B40	2CCS884001R0405	13077	0.98	1
25	50	S804C-B50	2CCS884001R0505	13237	0.98	1
25	63	S804C-B63	2CCS884001R0635	13398	0.98	1
25	80	S804C-B80	2CCS884001R0805	13558	0.98	1
25	100	S804C-B100	2CCS884001R0825	13718	0.98	1
25	125	S804C-B125	2CCS884001R0845	13879	0.98	1

S800C-C Characteristic C

$I_{cu} = 25 \text{ kA}$; with interchangeable cage terminal

1



ZCC413266F001



I_{cu} [kA]	Rated current [A]	Order details Type Code	Order code	GTIN EAN 76122712	Weight [kg]	Pack. unit
25	10	S801C-C10	2CCS881001R0104	12124	0.25	1
25	13	S801C-C13	2CCS881001R0134	12285	0.25	1
25	16	S801C-C16	2CCS881001R0164	12445	0.25	1
25	20	S801C-C20	2CCS881001R0204	12605	0.25	1
25	25	S801C-C25	2CCS881001R0254	12766	0.25	1
25	32	S801C-C32	2CCS881001R0324	12926	0.25	1
25	40	S801C-C40	2CCS881001R0404	13084	0.25	1
25	50	S801C-C50	2CCS881001R0504	13244	0.25	1
25	63	S801C-C63	2CCS881001R0634	13404	0.25	1
25	80	S801C-C80	2CCS881001R0804	13565	0.25	1
25	100	S801C-C100	2CCS881001R0824	13725	0.25	1
25	125	S801C-C125	2CCS881001R0844	13886	0.25	1



ZCC413267F001



25	10	S802C-C10	2CCS882001R0104	12131	0.49	1
25	13	S802C-C13	2CCS882001R0134	12292	0.49	1
25	16	S802C-C16	2CCS882001R0164	12452	0.49	1
25	20	S802C-C20	2CCS882001R0204	12612	0.49	1
25	25	S802C-C25	2CCS882001R0254	12773	0.49	1
25	32	S802C-C32	2CCS882001R0324	12933	0.49	1
25	40	S802C-C40	2CCS882001R0404	13091	0.49	1
25	50	S802C-C50	2CCS882001R0504	13251	0.49	1
25	63	S802C-C63	2CCS882001R0634	13411	0.49	1
25	80	S802C-C80	2CCS882001R0804	13572	0.49	1
25	100	S802C-C100	2CCS882001R0824	13732	0.49	1
25	125	S802C-C125	2CCS882001R0844	13893	0.49	1



ZCC413268F001



25	10	S803C-C10	2CCS883001R0104	12148	0.74	1
25	13	S803C-C13	2CCS883001R0134	12308	0.74	1
25	16	S803C-C16	2CCS883001R0164	12469	0.74	1
25	20	S803C-C20	2CCS883001R0204	12629	0.74	1
25	25	S803C-C25	2CCS883001R0254	12780	0.74	1
25	32	S803C-C32	2CCS883001R0324	12940	0.74	1
25	40	S803C-C40	2CCS883001R0404	13107	0.74	1
25	50	S803C-C50	2CCS883001R0504	13268	0.74	1
25	63	S803C-C63	2CCS883001R0634	13428	0.74	1
25	80	S803C-C80	2CCS883001R0804	13589	0.74	1
25	100	S803C-C100	2CCS883001R0824	13749	0.74	1
25	125	S803C-C125	2CCS883001R0844	13909	0.74	1



ZCC413269F001



25	10	S804C-C10	2CCS884001R0104	12155	0.98	1
25	13	S804C-C13	2CCS884001R0134	12315	0.98	1
25	16	S804C-C16	2CCS884001R0164	12476	0.98	1
25	20	S804C-C20	2CCS884001R0204	12636	0.98	1
25	25	S804C-C25	2CCS884001R0254	12797	0.98	1
25	32	S804C-C32	2CCS884001R0324	12957	0.98	1
25	40	S804C-C40	2CCS884001R0404	13114	0.98	1
25	50	S804C-C50	2CCS884001R0504	13275	0.98	1
25	63	S804C-C63	2CCS884001R0634	13435	0.98	1
25	80	S804C-C80	2CCS884001R0804	13596	0.98	1
25	100	S804C-C100	2CCS884001R0824	13756	0.98	1
25	125	S804C-C125	2CCS884001R0844	13916	0.98	1

S800C-D Characteristic D

$I_{CU} = 25 \text{ kA}$; with interchangeable cage terminal



2CC413270R001



I_{cu} [kA]	Rated current [A]	Order details Type Code	Order code	GTIN EAN 76122712	Weight [kg]	Pack. unit
25	10	S801C-D10	2CCS881001R0101	12162	0.25	1
25	13	S801C-D13	2CCS881001R0131	12322	0.25	1
25	16	S801C-D16	2CCS881001R0161	12483	0.25	1
25	20	S801C-D20	2CCS881001R0201	12643	0.25	1
25	25	S801C-D25	2CCS881001R0251	12803	0.25	1
25	32	S801C-D32	2CCS881001R0321	12964	0.25	1
25	40	S801C-D40	2CCS881001R0401	13121	0.25	1
25	50	S801C-D50	2CCS881001R0501	13282	0.25	1
25	63	S801C-D63	2CCS881001R0631	13442	0.25	1
25	80	S801C-D80	2CCS881001R0801	13602	0.25	1
25	100	S801C-D100	2CCS881001R0821	13763	0.25	1
25	125	S801C-D125	2CCS881001R0841	13923	0.25	1



2CC413271F001



25	10	S802C-D10	2CCS882001R0101	12179	0.49	1
25	13	S802C-D13	2CCS882001R0131	12339	0.49	1
25	16	S802C-D16	2CCS882001R0161	12490	0.49	1
25	20	S802C-D20	2CCS882001R0201	12650	0.49	1
25	25	S802C-D25	2CCS882001R0251	12810	0.49	1
25	32	S802C-D32	2CCS882001R0321	12971	0.49	1
25	40	S802C-D40	2CCS882001R0401	13138	0.49	1
25	50	S802C-D50	2CCS882001R0501	13299	0.49	1
25	63	S802C-D63	2CCS882001R0631	13459	0.49	1
25	80	S802C-D80	2CCS882001R0801	13619	0.49	1
25	100	S802C-D100	2CCS882001R0821	13770	0.49	1
25	125	S802C-D125	2CCS882001R0841	13930	0.49	1



2CC413272R001



25	10	S803C-D10	2CCS883001R0101	12186	0.74	1
25	13	S803C-D13	2CCS883001R0131	12346	0.74	1
25	16	S803C-D16	2CCS883001R0161	12506	0.74	1
25	20	S803C-D20	2CCS883001R0201	12667	0.74	1
25	25	S803C-D25	2CCS883001R0251	12827	0.74	1
25	32	S803C-D32	2CCS883001R0321	12988	0.74	1
25	40	S803C-D40	2CCS883001R0401	13145	0.74	1
25	50	S803C-D50	2CCS883001R0501	13305	0.74	1
25	63	S803C-D63	2CCS883001R0631	13466	0.74	1
25	80	S803C-D80	2CCS883001R0801	13626	0.74	1
25	100	S803C-D100	2CCS883001R0821	13787	0.74	1
25	125	S803C-D125	2CCS883001R0841	13947	0.74	1



2CC413273R001



25	10	S804C-D10	2CCS884001R0101	12193	0.98	1
25	13	S804C-D13	2CCS884001R0131	12353	0.98	1
25	16	S804C-D16	2CCS884001R0161	12513	0.98	1
25	20	S804C-D20	2CCS884001R0201	12674	0.98	1
25	25	S804C-D25	2CCS884001R0251	12834	0.98	1
25	32	S804C-D32	2CCS884001R0321	12995	0.98	1
25	40	S804C-D40	2CCS884001R0401	13152	0.98	1
25	50	S804C-D50	2CCS884001R0501	13312	0.98	1
25	63	S804C-D63	2CCS884001R0631	13473	0.98	1
25	80	S804C-D80	2CCS884001R0801	13633	0.98	1
25	100	S804C-D100	2CCS884001R0821	13794	0.98	1
25	125	S804C-D125	2CCS884001R0841	13954	0.98	1

S800C-K Characteristic K

$I_{cu} = 25 \text{ kA}$; with interchangeable cage terminal

1



2CCS413274R0001



I_{cu} [kA]	Rated current [A]	Order details Type Code	Order code	GTIN EAN 76122712	Weight [kg]	Pack. unit
25	10	S801C-K10	2CCS881001R0427	12209	0.25	1
25	13	S801C-K13	2CCS881001R0447	12360	0.25	1
25	16	S801C-K16	2CCS881001R0467	12520	0.25	1
25	20	S801C-K20	2CCS881001R0487	12681	0.25	1
25	25	S801C-K25	2CCS881001R0517	12841	0.25	1
25	32	S801C-K32	2CCS881001R0537	13008	0.25	1
25	40	S801C-K40	2CCS881001R0557	13169	0.25	1
25	50	S801C-K50	2CCS881001R0577	13329	0.25	1
25	63	S801C-K63	2CCS881001R0597	13480	0.25	1
25	80	S801C-K80	2CCS881001R0627	13640	0.25	1
25	100	S801C-K100	2CCS881001R0637	13800	0.25	1
25	125	S801C-K125	2CCS881001R0647	13961	0.25	1



2CCS413275F0001



25	10	S802C-K10	2CCS882001R0427	12216	0.49	1
25	13	S802C-K13	2CCS882001R0447	12377	0.49	1
25	16	S802C-K16	2CCS882001R0467	12537	0.49	1
25	20	S802C-K20	2CCS882001R0487	12698	0.49	1
25	25	S802C-K25	2CCS882001R0517	12858	0.49	1
25	32	S802C-K32	2CCS882001R0537	13015	0.49	1
25	40	S802C-K40	2CCS882001R0557	13176	0.49	1
25	50	S802C-K50	2CCS882001R0577	13336	0.49	1
25	63	S802C-K63	2CCS882001R0597	13497	0.49	1
25	80	S802C-K80	2CCS882001R0627	13657	0.49	1
25	100	S802C-K100	2CCS882001R0637	13817	0.49	1
25	125	S802C-K125	2CCS882001R0647	13978	0.49	1



2CCS413276F0001



25	10	S803C-K10	2CCS883001R0427	12223	0.74	1
25	13	S803C-K13	2CCS883001R0447	12384	0.74	1
25	16	S803C-K16	2CCS883001R0467	12544	0.74	1
25	20	S803C-K20	2CCS883001R0487	12704	0.74	1
25	25	S803C-K25	2CCS883001R0517	12865	0.74	1
25	32	S803C-K32	2CCS883001R0537	13022	0.74	1
25	40	S803C-K40	2CCS883001R0557	13183	0.74	1
25	50	S803C-K50	2CCS883001R0577	13343	0.74	1
25	63	S803C-K63	2CCS883001R0597	13503	0.74	1
25	80	S803C-K80	2CCS883001R0627	13664	0.74	1
25	100	S803C-K100	2CCS883001R0637	13824	0.74	1
25	125	S803C-K125	2CCS883001R0647	13985	0.74	1

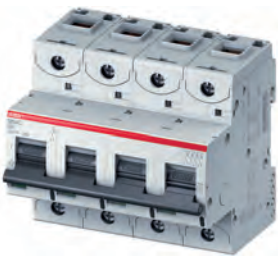

2CCS413277F0001



25	10	S804C-K10	2CCS884001R0427	12230	0.98	1
25	13	S804C-K13	2CCS884001R0447	12391	0.98	1
25	16	S804C-K16	2CCS884001R0467	12551	0.98	1
25	20	S804C-K20	2CCS884001R0487	12711	0.98	1
25	25	S804C-K25	2CCS884001R0517	12872	0.98	1
25	32	S804C-K32	2CCS884001R0537	13039	0.98	1
25	40	S804C-K40	2CCS884001R0557	13190	0.98	1
25	50	S804C-K50	2CCS884001R0577	13350	0.98	1
25	63	S804C-K63	2CCS884001R0597	13510	0.98	1
25	80	S804C-K80	2CCS884001R0627	13671	0.98	1
25	100	S804C-K100	2CCS884001R0637	13831	0.98	1
25	125	S804C-K125	2CCS884001R0647	13992	0.98	1

S800B-B Characteristic B

$I_{CU} = 16 \text{ kA}$; with locked cage terminal



2CCCA13368F0001



2CCCA13369F0001



2CCCA13370F0001

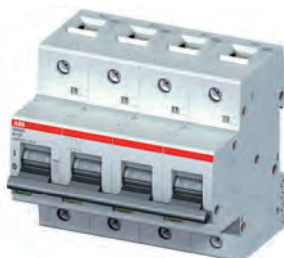

2CCCA13371F0001



I_{cu} [kA]	Rated current [A]	Order details Type Code	Order code	GTIN EAN 76122714	Weight [kg]	Pack. unit
16	32	S801B-B32	2CCS811001R0325	15303	0.24	1
16	40	S801B-B40	2CCS811001R0405	16539	0.24	1
16	50	S801B-B50	2CCS811001R0505	16577	0.24	1
16	63	S801B-B63	2CCS811001R0635	16614	0.24	1
16	80	S801B-B80	2CCS811001R0805	16652	0.24	1
16	100	S801B-B100	2CCS811001R0825	16690	0.24	1
16	125	S801B-B125	2CCS811001R0845	16737	0.24	1

16	32	S802B-B32	2CCS812001R0325	16508	0.49	1
16	40	S802B-B40	2CCS812001R0405	16546	0.49	1
16	50	S802B-B50	2CCS812001R0505	16584	0.49	1
16	63	S802B-B63	2CCS812001R0635	16621	0.49	1
16	80	S802B-B80	2CCS812001R0805	16669	0.49	1
16	100	S802B-B100	2CCS812001R0825	16706	0.49	1
16	125	S802B-B125	2CCS812001R0845	16744	0.49	1

16	32	S803B-B32	2CCS813001R0325	16515	0.74	1
16	40	S803B-B40	2CCS813001R0405	16553	0.74	1
16	50	S803B-B50	2CCS813001R0505	16591	0.74	1
16	63	S803B-B63	2CCS813001R0635	16638	0.74	1
16	80	S803B-B80	2CCS813001R0805	16676	0.74	1
16	100	S803B-B100	2CCS813001R0825	16713	0.74	1
16	125	S803B-B125	2CCS813001R0845	16751	0.74	1

16	32	S804B-B32	2CCS814001R0325	16522	0.98	1
16	40	S804B-B40	2CCS814001R0405	16560	0.98	1
16	50	S804B-B50	2CCS814001R0505	16607	0.98	1
16	63	S804B-B63	2CCS814001R0635	16645	0.98	1
16	80	S804B-B80	2CCS814001R0805	16683	0.98	1
16	100	S804B-B100	2CCS814001R0825	16720	0.98	1
16	125	S804B-B125	2CCS814001R0845	16768	0.98	1

S800B-C Characteristic C

$I_{cu} = 16 \text{ kA}$; with locked cage terminal

1



2CCC413368FR001



2CCC413369FR001



2CCC413370FR001



2CCC413371FR001



I_{cu} [kA]	Rated current [A]	Order details Type Code	Order code	GTIN EAN 76122714	Weight [kg]	Pack. unit
16	32	S801B-C32	2CCS811001R0324	16225	0.24	1
16	40	S801B-C40	2CCS811001R0404	16263	0.24	1
16	50	S801B-C50	2CCS811001R0504	16300	0.24	1
16	63	S801B-C63	2CCS811001R0634	16348	0.24	1
16	80	S801B-C80	2CCS811001R0804	16386	0.24	1
16	100	S801B-C100	2CCS811001R0824	16423	0.24	1
16	125	S801B-C125	2CCS811001R0844	16461	0.24	1

16	32	S802B-C32	2CCS812001R0324	16232	0.49	1
16	40	S802B-C40	2CCS812001R0404	16270	0.49	1
16	50	S802B-C50	2CCS812001R0504	16317	0.49	1
16	63	S802B-C63	2CCS812001R0634	16355	0.49	1
16	80	S802B-C80	2CCS812001R0804	16393	0.49	1
16	100	S802B-C100	2CCS812001R0824	16430	0.49	1
16	125	S802B-C125	2CCS812001R0844	16478	0.49	1

16	32	S803B-C32	2CCS813001R0324	16249	0.74	1
16	40	S803B-C40	2CCS813001R0404	16287	0.74	1
16	50	S803B-C50	2CCS813001R0504	16324	0.74	1
16	63	S803B-C63	2CCS813001R0634	16362	0.74	1
16	80	S803B-C80	2CCS813001R0804	16409	0.74	1
16	100	S803B-C100	2CCS813001R0824	16447	0.74	1
16	125	S803B-C125	2CCS813001R0844	16485	0.74	1

16	32	S804B-C32	2CCS814001R0324	16256	0.98	1
16	40	S804B-C40	2CCS814001R0404	16294	0.98	1
16	50	S804B-C50	2CCS814001R0504	16331	0.98	1
16	63	S804B-C63	2CCS814001R0634	16379	0.98	1
16	80	S804B-C80	2CCS814001R0804	16416	0.98	1
16	100	S804B-C100	2CCS814001R0824	16454	0.98	1
16	125	S804B-C125	2CCS814001R0844	16492	0.98	1

S800B-D Characteristic D

$I_{CU} = 16 \text{ kA}$; with locked cage terminal



ZCC413368F0001



ZCC413369F0001



ZCC413370F0001

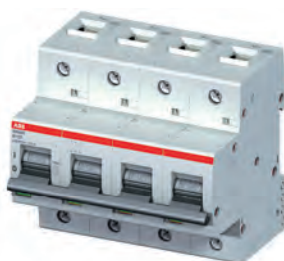

ZCC413371F0001

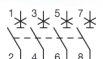

I_{cu} [kA]	Rated current [A]	Order details Type Code	Order code	GTIN EAN 76122714	Weight [kg]	Pack. unit
16	32	S801B-D32	2CCS811001R0321	15945	0.24	1
16	40	S801B-D40	2CCS811001R0401	15983	0.24	1
16	50	S801B-D50	2CCS811001R0501	16027	0.24	1
16	63	S801B-D63	2CCS811001R0631	16065	0.24	1
16	80	S801B-D80	2CCS811001R0801	16102	0.24	1
16	100	S801B-D100	2CCS811001R0821	16140	0.24	1
16	125	S801B-D125	2CCS811001R0841	16188	0.24	1

16	32	S802B-D32	2CCS812001R0321	15952	0.49	1
16	40	S802B-D40	2CCS812001R0401	15990	0.49	1
16	50	S802B-D50	2CCS812001R0501	16034	0.49	1
16	63	S802B-D63	2CCS812001R0631	16072	0.49	1
16	80	S802B-D80	2CCS812001R0801	16119	0.49	1
16	100	S802B-D100	2CCS812001R0821	16157	0.49	1
16	125	S802B-D125	2CCS812001R0841	16195	0.49	1

16	32	S803B-D32	2CCS813001R0321	15969	0.74	1
16	40	S803B-D40	2CCS813001R0401	16003	0.74	1
16	50	S803B-D50	2CCS813001R0501	16041	0.74	1
16	63	S803B-D63	2CCS813001R0631	16089	0.74	1
16	80	S803B-D80	2CCS813001R0801	16126	0.74	1
16	100	S803B-D100	2CCS813001R0821	16164	0.74	1
16	125	S803B-D125	2CCS813001R0841	16201	0.74	1

16	32	S804B-D32	2CCS814001R0321	15976	0.98	1
16	40	S804B-D40	2CCS814001R0401	16010	0.98	1
16	50	S804B-D50	2CCS814001R0501	16058	0.98	1
16	63	S804B-D63	2CCS814001R0631	16096	0.98	1
16	80	S804B-D80	2CCS814001R0801	16133	0.98	1
16	100	S804B-D100	2CCS814001R0821	16171	0.98	1
16	125	S804B-D125	2CCS814001R0841	16218	0.98	1

S800B-K Characteristic K

$I_{cu} = 16 \text{ kA}$; with locked cage terminal

1



ZCC41336F0001



I_{cu} [kA]	Rated current [A]	Order details Type Code	Order code	GTIN EAN 76122714	Weight [kg]	Pack. unit
16	32	S801B-K32	2CCS811001R0537	15600	0.24	1
16	40	S801B-K40	2CCS811001R0557	15723	0.24	1
16	50	S801B-K50	2CCS811001R0577	15730	0.24	1
16	63	S801B-K63	2CCS811001R0597	15778	0.24	1
16	80	S801B-K80	2CCS811001R0627	15815	0.24	1
16	100	S801B-K100	2CCS811001R0637	15860	0.24	1
16	125	S801B-K125	2CCS811001R0647	15907	0.24	1



ZCC41336F0001



16	32	S802B-K32	2CCS812001R0537	15709	0.49	1
16	40	S802B-K40	2CCS812001R0557	16775	0.49	1
16	50	S802B-K50	2CCS812001R0577	15747	0.49	1
16	63	S802B-K63	2CCS812001R0597	15785	0.49	1
16	80	S802B-K80	2CCS812001R0627	15822	0.49	1
16	100	S802B-K100	2CCS812001R0637	15877	0.49	1
16	125	S802B-K125	2CCS812001R0647	15914	0.49	1



ZCC41337F0001



16	32	S803B-K32	2CCS813001R0537	15716	0.74	1
16	40	S803B-K40	2CCS813001R0557	16799	0.74	1
16	50	S803B-K50	2CCS813001R0577	15754	0.74	1
16	63	S803B-K63	2CCS813001R0597	15792	0.74	1
16	80	S803B-K80	2CCS813001R0627	15846	0.74	1
16	100	S803B-K100	2CCS813001R0637	15884	0.74	1
16	125	S803B-K125	2CCS813001R0647	15921	0.74	1

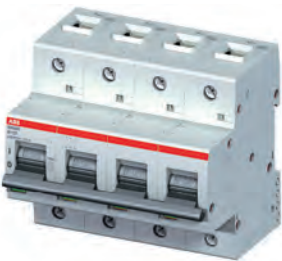

ZCC41337F0001



16	32	S804B-K32	2CCS814001R0537	16805	0.98	1
16	40	S804B-K40	2CCS814001R0557	16812	0.98	1
16	50	S804B-K50	2CCS814001R0577	15761	0.98	1
16	63	S804B-K63	2CCS814001R0597	15808	0.98	1
16	80	S804B-K80	2CCS814001R0627	15853	0.98	1
16	100	S804B-K100	2CCS814001R0637	15891	0.98	1
16	125	S804B-K125	2CCS814001R0647	15938	0.98	1

S800HV-K Characteristic K

$I_{CU} = 4 \text{ kA}$ for voltages up to 1000V AC



I_{cu} [kA]	Rated current [A]	Order details Type code	Order code	GTIN EAN 76122714	Weight [kg]	Pack. unit
4	6	S801HV-K6	2CCF019005R0001	36445	0.27	1
4	8	S801HV-K8	2CCF019006R0001	36964	0.27	1
4	10	S801HV-K10	2CCF019007R0001	36452	0.27	1
4	13	S801HV-K13	2CCF019008R0001	36469	0.27	1
4	16	S801HV-K16	2CCF019009R0001	36476	0.27	1
4	20	S801HV-K20	2CCF019010R0001	36483	0.27	1
4	25	S801HV-K25	2CCF019011R0001	36490	0.27	1
4	32	S801HV-K32	2CCF019012R0001	36605	0.27	1
4	40	S801HV-K40	2CCF019013R0001	36612	0.27	1
4	50	S801HV-K50	2CCF019014R0001	36629	0.27	1
4	63	S801HV-K63	2CCF019015R0001	36636	0.27	1
3	80	S801HV-K80	2CCF019016R0001	36643	0.27	1
3	100	S801HV-K100	2CCF019017R0001	36650	0.27	1
3	125	S801HV-K125	2CCF019018R0001	36667	0.27	1



4	6	S802HV-K6	2CCF019019R0001	36674	0.54	1
4	8	S802HV-K8	2CCF019020R0001	36681	0.54	1
4	10	S802HV-K10	2CCF019021R0001	36698	0.54	1
4	13	S802HV-K13	2CCF019022R0001	36704	0.54	1
4	16	S802HV-K16	2CCF019023R0001	36711	0.54	1
4	20	S802HV-K20	2CCF019024R0001	36728	0.54	1
4	25	S802HV-K25	2CCF019025R0001	36742	0.54	1
4	32	S802HV-K32	2CCF019026R0001	36759	0.54	1
4	40	S802HV-K40	2CCF019027R0001	36766	0.54	1
4	50	S802HV-K50	2CCF019028R0001	36773	0.54	1
4	63	S802HV-K63	2CCF019029R0001	36780	0.54	1
3	80	S802HV-K80	2CCF019030R0001	36797	0.54	1
3	100	S802HV-K100	2CCF019031R0001	36803	0.54	1
3	125	S802HV-K125	2CCF019032R0001	36810	0.54	1



4	6	S803HV-K6	2CCF019033R0001	36827	0.81	1
4	8	S803HV-K8	2CCF019034R0001	36834	0.81	1
4	10	S803HV-K10	2CCF019035R0001	36841	0.81	1
4	13	S803HV-K13	2CCF019036R0001	36858	0.81	1
4	16	S803HV-K16	2CCF019037R0001	36865	0.81	1
4	20	S803HV-K20	2CCF019038R0001	36872	0.81	1
4	25	S803HV-K25	2CCF019039R0001	36889	0.81	1
4	32	S803HV-K32	2CCF019040R0001	36896	0.81	1
4	40	S803HV-K40	2CCF019041R0001	36902	0.81	1
4	50	S803HV-K50	2CCF019042R0001	36919	0.81	1
4	63	S803HV-K63	2CCF019043R0001	36926	0.81	1
3	80	S803HV-K80	2CCF019044R0001	36933	0.81	1
3	100	S803HV-K100	2CCF019045R0001	36940	0.81	1
3	125	S803HV-K125	2CCF019046R0001	36957	0.81	1

S800U-K Characteristic K (UL489 certified)

$I_{cu} = 30 \text{ kA}$; with interchangeable cage terminal

1



2CCS41334F002



I_{cu} [kA]	Rated current [A]	Order details Type Code	Order code	GTIN EAN 76122712	Weight [kg]	Pack. unit
30	10	S801U-K10	2CCS881017R0427	14005	0.25	1
30	15	S801U-K15	2CCS881017R0457	14043	0.25	1
30	20	S801U-K20	2CCS881017R0487	14081	0.25	1
30	25	S801U-K25	2CCS881017R0517	14128	0.25	1
30	30	S801U-K30	2CCS881017R0527	14166	0.25	1
30	40	S801U-K40	2CCS881017R0557	14203	0.25	1
30	50	S801U-K50	2CCS881017R0577	14241	0.25	1
30	60	S801U-K60	2CCS881017R0587	14289	0.25	1
30	70	S801U-K70	2CCS881017R0707	14326	0.25	1
30	80	S801U-K80	2CCS881017R0627	14364	0.25	1
30	90	S801U-K90	2CCS881017R0907	14401	0.25	1
30	100	S801U-K100	2CCS881017R0637	14449	0.25	1



2CCS413305F002



50	10	S802U-K10	2CCS862017R0427	14012	0.49	1
50	15	S802U-K15	2CCS862017R0457	14050	0.49	1
50	20	S802U-K20	2CCS862017R0487	14098	0.49	1
50	25	S802U-K25	2CCS862017R0517	14135	0.49	1
50	30	S802U-K30	2CCS862017R0527	14173	0.49	1
50	40	S802U-K40	2CCS862017R0557	14210	0.49	1
50	50	S802U-K50	2CCS862017R0577	14258	0.49	1
50	60	S802U-K60	2CCS862017R0587	14296	0.49	1
50	70	S802U-K70	2CCS862017R0707	14333	0.49	1
50	80	S802U-K80	2CCS862017R0627	14371	0.49	1
50	90	S802U-K90	2CCS862017R0907	14418	0.49	1
50	100	S802U-K100	2CCS862017R0637	14456	0.49	1



2CCS413306F002



50	10	S803U-K10	2CCS863017R0427	14029	0.74	1
50	15	S803U-K15	2CCS863017R0457	14067	0.74	1
50	20	S803U-K20	2CCS863017R0487	14104	0.74	1
50	25	S803U-K25	2CCS863017R0517	14142	0.74	1
50	30	S803U-K30	2CCS863017R0527	14180	0.74	1
50	40	S803U-K40	2CCS863017R0557	14227	0.74	1
50	50	S803U-K50	2CCS863017R0577	14265	0.74	1
50	60	S803U-K60	2CCS863017R0587	14302	0.74	1
50	70	S803U-K70	2CCS863017R0707	14340	0.74	1
50	80	S803U-K80	2CCS863017R0627	14388	0.74	1
50	90	S803U-K90	2CCS863017R0907	14425	0.74	1
50	100	S803U-K100	2CCS863017R0637	14463	0.74	1

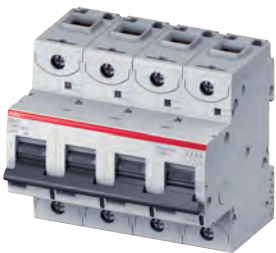

2CCS413307F002



50	10	S804U-K10	2CCS864017R0427	14036	0.98	1
50	15	S804U-K15	2CCS864017R0457	14074	0.98	1
50	20	S804U-K20	2CCS864017R0487	14111	0.98	1
50	25	S804U-K25	2CCS864017R0517	14159	0.98	1
50	30	S804U-K30	2CCS864017R0527	14197	0.98	1
50	40	S804U-K40	2CCS864017R0557	14234	0.98	1
50	50	S804U-K50	2CCS864017R0577	14272	0.98	1
50	60	S804U-K60	2CCS864017R0587	14319	0.98	1
50	70	S804U-K70	2CCS864017R0707	14357	0.98	1
50	80	S804U-K80	2CCS864017R0627	14395	0.98	1
50	90	S804U-K90	2CCS864017R0907	14432	0.98	1
50	100	S804U-K100	2CCS864017R0637	14470	0.98	1

S800U-Z Characteristic Z (UL489 certified)

$I_{cu} = 50 \text{ kA}$; with interchangeable cage terminal



2CCC413315F0001



I_{cu} [kA]	Rated current [A]	Order details Type Code	Order code	GTIN EAN 76122712	Weight [kg]	Pack. unit
30	10	S801U-Z10	2CCS881017R0105	14487	0.25	1
30	15	S801U-Z15	2CCS881017R0155	14524	0.25	1
30	20	S801U-Z20	2CCS881017R0205	14562	0.25	1
30	25	S801U-Z25	2CCS881017R0255	14609	0.25	1
30	30	S801U-Z30	2CCS881017R0305	14647	0.25	1
30	40	S801U-Z40	2CCS881017R0405	14685	0.25	1
30	50	S801U-Z50	2CCS881017R0505	14722	0.25	1
30	60	S801U-Z60	2CCS881017R0605	14760	0.25	1
30	70	S801U-Z70	2CCS881017R0705	14807	0.25	1
30	80	S801U-Z80	2CCS881017R0805	14845	0.25	1
30	90	S801U-Z90	2CCS881017R0905	14883	0.25	1
30	100	S801U-Z100	2CCS881017R0825	14920	0.25	1



2CCC413316F0001



50	10	S802U-Z10	2CCS862017R0105	14494	0.49	1
50	15	S802U-Z15	2CCS862017R0155	14531	0.49	1
50	20	S802U-Z20	2CCS862017R0205	14579	0.49	1
50	25	S802U-Z25	2CCS862017R0255	14616	0.49	1
50	30	S802U-Z30	2CCS862017R0305	14654	0.49	1
50	40	S802U-Z40	2CCS862017R0405	14692	0.49	1
50	50	S802U-Z50	2CCS862017R0505	14739	0.49	1
50	60	S802U-Z60	2CCS862017R0605	14777	0.49	1
50	70	S802U-Z70	2CCS862017R0705	14814	0.49	1
50	80	S802U-Z80	2CCS862017R0805	14852	0.49	1
50	90	S802U-Z90	2CCS862017R0905	14890	0.49	1
50	100	S802U-Z100	2CCS862017R0825	14937	0.49	1



2CCC413317F0001



50	10	S803U-Z10	2CCS863017R0105	14500	0.74	1
50	15	S803U-Z15	2CCS863017R0155	14548	0.74	1
50	20	S803U-Z20	2CCS863017R0205	14586	0.74	1
50	25	S803U-Z25	2CCS863017R0255	14623	0.74	1
50	30	S803U-Z30	2CCS863017R0305	14661	0.74	1
50	40	S803U-Z40	2CCS863017R0405	14708	0.74	1
50	50	S803U-Z50	2CCS863017R0505	14746	0.74	1
50	60	S803U-Z60	2CCS863017R0605	14784	0.74	1
50	70	S803U-Z70	2CCS863017R0705	14821	0.74	1
50	80	S803U-Z80	2CCS863017R0805	14869	0.74	1
50	90	S803U-Z90	2CCS863017R0905	14906	0.74	1
50	100	S803U-Z100	2CCS863017R0825	14944	0.74	1



2CCC413318F0001



50	10	S804U-Z10	2CCS864017R0105	14517	0.98	1
50	15	S804U-Z15	2CCS864017R0155	14555	0.98	1
50	20	S804U-Z20	2CCS864017R0205	14593	0.98	1
50	25	S804U-Z25	2CCS864017R0255	14630	0.98	1
50	30	S804U-Z30	2CCS864017R0305	14678	0.98	1
50	40	S804U-Z40	2CCS864017R0405	14715	0.98	1
50	50	S804U-Z50	2CCS864017R0505	14753	0.98	1
50	60	S804U-Z60	2CCS864017R0605	14791	0.98	1
50	70	S804U-Z70	2CCS864017R0705	14838	0.98	1
50	80	S804U-Z80	2CCS864017R0805	14876	0.98	1
50	90	S804U-Z90	2CCS864017R0905	14913	0.98	1
50	100	S804U-Z100	2CCS864017R0825	14951	0.98	1

S804U-UCZ (UL489 certified)

I_{cu} =10 kA for voltages up to 600V DC

1



2CCS248357R0001

I_{cu} [kA]	Rated current [A]	Order details Type Code	Order code	GTIN EAN 7612271	Weight [kg]	Pack. unit
10	10	S804U-UCZ10	2CCS248356R0001	420703	0.98	1
10	15	S804U-UCZ15	2CCS248357R0001	420710	0.98	1
10	20	S804U-UCZ20	2CCS248358R0001	420727	0.98	1
10	25	S804U-UCZ25	2CCS248359R0001	420734	0.98	1
10	30	S804U-UCZ30	2CCS248360R0001	420741	0.98	1
10	40	S804U-UCZ40	2CCS248361R0001	420758	0.98	1
10	50	S804U-UCZ50	2CCS248362R0001	420765	0.98	1
10	60	S804U-UCZ60	2CCS248363R0001	420772	0.98	1
10	70	S804U-UCZ70	2CCS248364R0001	420789	0.98	1
10	80	S804U-UCZ80	2CCS248365R0001	420796	0.98	1

S800PV-SP Characteristic PV-SP (used in photovoltaic systems)

Photovoltaic string protection with interchangeable cage terminal



ZCC413246R0001



I _{cu} [kA]	Rated current		Order details	Order code	GTIN EAN	Weight	Pack.
	[A]	Type Code			76122712	[kg]	unit
5	5	S802PV-SP5	2CCF019596R0001	71170	0.49	1	
5	6	S802PV-SP6	2CCF019643R0001	72115	0.49	1	
5	8	S802PV-SP8	2CCF019644R0001	72139	0.49	1	
5	10	S802PV-SP10	2CCF019597R0001	71194	0.49	1	
5	13	S802PV-SP13	2CCF019598R0001	71217	0.49	1	
5	16	S802PV-SP16	2CCF019599R0001	71231	0.49	1	
5	20	S802PV-SP20	2CCF019600R0001	71255	0.49	1	
5	25	S802PV-SP25	2CCF019601R0001	71279	0.49	1	
5	32	S802PV-SP32	2CCF019602R0001	71293	0.49	1	
5	40	S802PV-SP40	2CCF019603R0001	71316	0.49	1	
5	50	S802PV-SP50	2CCF019604R0001	71330	0.49	1	
5	63	S802PV-SP63	2CCF019605R0001	71354	0.49	1	
5	80	S802PV-SP80	2CCF019606R0001	71378	0.49	1	
5	100	S802PV-SP100	2CCF019607R0001	71392	0.49	1	
5	125	S802PV-SP125	2CCF019608R0001	71415	0.49	1	



ZCC413247R0001



5	5	S803PV-SP5	2CCF019609R0001	71439	0.74	1
5	6	S803PV-SP6	2CCF019645R0001	72153	0.74	1
5	8	S803PV-SP8	2CCF019646R0001	72177	0.74	1
5	10	S803PV-SP10	2CCF019610R0001	71453	0.74	1
5	13	S803PV-SP13	2CCF019611R0001	71477	0.74	1
5	16	S803PV-SP16	2CCF019612R0001	71491	0.74	1
5	20	S803PV-SP20	2CCF019613R0001	71514	0.74	1
5	25	S803PV-SP25	2CCF019614R0001	71538	0.74	1
5	32	S803PV-SP32	2CCF019615R0001	71552	0.74	1
5	40	S803PV-SP40	2CCF019616R0001	71576	0.74	1
5	50	S803PV-SP50	2CCF019617R0001	71590	0.74	1
5	63	S803PV-SP63	2CCF019618R0001	71613	0.74	1
5	80	S803PV-SP80	2CCF019619R0001	71637	0.74	1
5	100	S803PV-SP100	2CCF019620R0001	71651	0.74	1
5	125	S803PV-SP125	2CCF019621R0001	71675	0.74	1



ZCC413248R0001



5	5	S804PV-SP5	2CCF019586R0001	52124	0.98	1
5	6	S804PV-SP6	2CCF019647R0001	72191	0.98	1
5	8	S804PV-SP8	2CCF019648R0001	72214	0.98	1
5	10	S804PV-SP10	2CCF019622R0001	71699	0.98	1
5	13	S804PV-SP13	2CCF019623R0001	71712	0.98	1
5	16	S804PV-SP16	2CCF019624R0001	71736	0.98	1
5	20	S804PV-SP20	2CCF019625R0001	71750	0.98	1
5	25	S804PV-SP25	2CCF019626R0001	71774	0.98	1
5	32	S804PV-SP32	2CCF019627R0001	71798	0.98	1
5	40	S804PV-SP40	2CCF019628R0001	71811	0.98	1
5	50	S804PV-SP50	2CCF019629R0001	71835	0.98	1
5	63	S804PV-SP63	2CCF019630R0001	71859	0.98	1
5	80	S804PV-SP80	2CCF019631R0001	71873	0.98	1
5	100	S804PV-SP100	2CCF019632R0001	71897	0.98	1
5	125	S804PV-SP125	2CCF019633R0001	71910	0.98	1

S800PV-SD (used in photovoltaic systems)

Photovoltaic disconnecter with interchangeable cage terminal

1



2CCCF019635R0001



I_{cw} [kA]	Rated current [A]	Order details Type Code	Order code	GTIN EAN 76122712	Weight [kg]	Pack. unit
1.5	32	S802PV-SD32	2CCF019635R0001	71958	0.43	1
1.5	63	S802PV-SD63	2CCF019634R0001	71934	0.43	1
1.5	125	S802PV-SD125	2CCF019636R0001	71972	0.43	1



2CCCF019637R0001



1.5	32	S803PV-SD32	2CCF019637R0001	71996	0.65	1
1.5	63	S803PV-SD63	2CCF019638R0001	72016	0.65	1
1.5	125	S803PV-SD125	2CCF019639R0001	72030	0.65	1



2CCCF019640R0001



1.5	32	S804PV-SD32	2CCF019640R0001	72054	0.86	1
1.5	63	S804PV-SD63	2CCF019641R0001	72078	0.86	1
1.5	125	S804PV-SD125	2CCF019642R0001	72092	0.86	1

S802PV-M-H (used in photovoltaic systems) Photovoltaic 2-pole disconnecter (polarized)

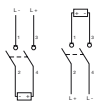

I_{cw} [kA]	Rated current [A]	Order details Type Code	Order code	GTIN EAN 7612271	Weight [kg]	Pack. unit
1.5	32	S802PV-M32-H	2CCP247204R0001	419035	0.43	1
1.5	63	S802PV-M63-H	2CCP247205R0001	419042	0.43	1
1.5	100	S802PV-M100-H	2CCP247212R0001	419301	0.43	1

S804U-PVS (UL489B certified, used in photovoltaic systems) Ground fault detector interrupter (GFDI)

1

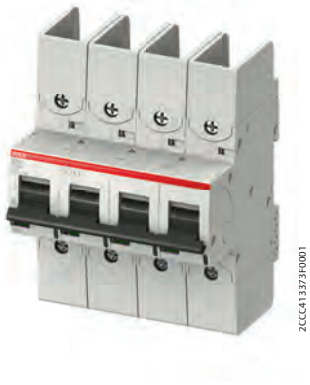

I_{cu} [kA]	Rated current [A]	Order details Type Code	Order code	GTIN EAN 7612271	Weight [kg]	Pack. unit
3	5	S804U-PVS5	2CCP824017R1159	419929	0.98	1

S800 Accessories



2CCS13069F0001



Auxiliary contact	Order details Type Code	Order code	GTIN EAN 761227	Weight [kg]	Pack. unit
Auxiliary contact	S800-AUX	2CCS800900R0011	1206802	0.05	1



2CCS13070F0001



Combined auxiliary and signal contact	Order details Type Code	Order code	GTIN EAN 761227	Weight [kg]	Pack. unit
Auxiliary/signal contact	S800-AUX/ALT	2CCS800900R0021	1206819	0.05	1



2CCS13067F0001

Disconnectable neutral conductor 63 A	Order details Type Code	Order code	GTIN EAN 761227	Weight [kg]	Pack. unit
Disconnectable neutral conductor 63 A	S800-NT	2CCS800900R0061	1208196	0.12	1



2CCS413353F0001

Remote Switching Unit *	Order details Type Code	Order code	GTIN EAN 761227	Weight [kg]	Pack. unit
Remote Switching Unit S800-RSU-H	S800-RSU-H	2CCS800900R0501	1411244	0.3	1
Remote Switching Unit S800W-RSU	S800W-RSU	2CCS800900R0511	1411169	0.3	1

* High performance circuit breaker is not included in delivery



2CCS413357F0001

S800-RSU cable incl. plug	Order details Type Code	Order code	GTIN EAN 761227	Weight [kg]	Pack. unit
3 meters cable 0,5 mm ² (AWG20) incl. 10-pole Micro Fit 3.0 plug	S800-RSU-CP	2CCS800900R0541	1412869	0.35	1

10-pole Micro Fit 3.0 plug	Order details Type Code	Order code	GTIN EAN 761227	Weight [kg]	Pack. unit
10-pole Micro Fit 3.0 plug	S800-RSU-P	2CCS800900R0551	1412845	0.00	1

S800 Accessories

1



2CCC413019F0002



Short-circuit current with interchangeable cage terminal [A]	Order details Type Code	Order code	GTIN EAN 7612271	Weight [kg]	Pack. unit
32	S803S-SCL32	2CCS800900R0291	1208912	0.74	1
63	S803S-SCL63	2CCS800900R0301	1208929	0.74	1
125	S803S-SCL125	2CCS800900R0281	1208905	0.74	1



2CCC413020F0001



Short-circuit current limiter with interchangeable ring terminal connection [A]	Order details Type Code	Order code	GTIN EAN 761227	Weight [kg]	Pack. unit
32	S803S-SCL32-R	2CCS800900R0332	1408916	0.74	1
63	S803S-SCL63-R	2CCS800900R0331	1208950	0.74	1
125	S803S-SCL125-R	2CCS800900R0311	1208936	0.74	1



2CCC413028F0001

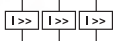

Self-resetting short-circuit limiter IEC version [A]	Order details Type Code	Order code	GTIN EAN 7612271	Weight [kg]	Pack. unit
32	S801S-SCL32-SR	2CCS801901R0539	412012	0.25	1
63	S801S-SCL63-SR	2CCS801901R0599	412036	0.25	1
100	S801S-SCL100-SR	2CCS801901R0639	411992	0.25	1
32	S802S-SCL32-SR	2CCS802901R0539	412074	0.5	1
63	S802S-SCL63-SR	2CCS802901R0599	412098	0.5	1
100	S802S-SCL100-SR	2CCS802901R0639	412050	0.5	1
32	S803S-SCL32-SR	2CCS803901R0539	411930	0.75	1
63	S803S-SCL63-SR	2CCS803901R0599	411947	0.75	1
100	S803S-SCL100-SR	2CCS803901R0639	411954	0.75	1



2CCC413364F0001

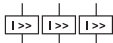

Self-resetting short-circuit limiter World version (IEC/UL) [A]	Order details Type Code	Order code	GTIN EAN 7612271	Weight [kg]	Pack. unit
32	S803W-SCL32-SR	2CCS803917R0539	412319	0.75	1
63	S803W-SCL63-SR	2CCS803917R0599	412326	0.75	1
100	S803W-SCL100-SR	2CCS803917R0639	412302	0.75	1

S800 Accessories



2CCCF013408F0001

Self-resetting short-circuit limiter [A]	Order details Type code	Order code	GTIN EAN 76122714	Weight [kg]	Pack. unit
32	S803HV-SCL32-SR	2CCCF019047R0001	37008	0.75	1
63	S803HV-SCL63-SR	2CCCF019048R0001	37107	0.75	1
100	S803HV-SCL100-SR	2CCCF019049R0001	37114	0.75	1



2CCCF013239F0001



Shunt operation release	Order details Type Code	Order code	GTIN EAN 761227	Weight [kg]	Pack. unit
Shunt operat. release 12 VAC/DC	S800-SOR12	2CCS800900R0201	1212070	0.15	1
Shunt operat. release 24 VAC/DC	S800-SOR24	2CCS800900R0191	1208318	0.15	1
Shunt operat. release 48...130 VAC/DC	S800-SOR130	2CCS800900R0221	1208349	0.15	1
Shunt operat. release 110...250 VAC/DC	S800-SOR250	2CCS800900R0211	1208332	0.15	1
Shunt operat. release 220...400 VAC/DC	S800-SOR400	2CCS800900R0231	1208356	0.15	1



2CCCF013240F0001



Undervoltage release	Order details Type Code	Order code	GTIN EAN 761227	Weight [kg]	Pack. unit
Undervoltage release 24...36 VAC/DC	S800-UVR36	2CCS800900R0241	1208363	0.15	1
Undervoltage release 48...60 VAC/DC	S800-UVR60	2CCS800900R0251	1208370	0.15	1
Undervoltage release 110...130 VAC/DC	S800-UVR130	2CCS800900R0261	1208387	0.15	1
Undervoltage release 220...250 VAC/DC	S800-UVR250	2CCS800900R0271	1208394	0.15	1



2CCCF013061F0002

Rotary drive adapter for 2- to 4-pole high performance MCB	Order details Type Code	Order code	GTIN EAN 80156446	Weight [kg]	Pack. unit
Rotary drive	S800-RD	2CCS800900R0041	25764	0.08	1



2CCCF013902F0001

Anthracite/Standard rotary handle for door assembly	Order details Type Code	Order code	GTIN EAN 80156446	Weight [kg]	Pack. unit
Anthracite rotary handle	S800-RHE-H	1SDA060150R0001	25571	0.21	1

S800 Accessories

1



2CC413063F001

Red/Emergency rotary handle for door assembly	Order details	Order code	GTIN EAN	Weight	Pack.
	Type Code		80156446	[kg]	unit
Red rotary handle	S800-RHE-EM	1SDA060151R0001	25771	0.21	1



2CC413064F001

Axle extension Rotary drive-rotary handle 6 x 6 mm	Order details	Order code	GTIN EAN	Weight	Pack.
	Type Code		80156446	[kg]	unit
Axial extension 500 mm	S800-RHE-S	1SDA060179R0001	26242	0.2	1



2CC413068F001

IP54 kit for door mounting	Order details	Order code	GTIN EAN	Weight	Pack.
	Type Code		80156446	[kg]	unit
IP54 Kit	S800-RHE-IP54	1SDA060180R0001	26259	0.08	1

Intermediate piece 9 mm	Order details	Order code	GTIN EAN	Weight	Pack.
	Type Code		76122712	[kg]	unit
Intermediate piece 9 mm	S800-IP9	2CCS800900R0031	08202	0.01	1



2CC413066F001

Padlock lever lock with hasp	Order details	Order code	GTIN EAN	Weight	Pack.
	Type Code		76122712	[kg]	unit
Padlock lever lock with hasp 4 mm	S800-PLL	2CCS800900R0051	08189	0.12	10



2CC413308F001

UL locking device*	Order details	Order code	GTIN EAN	Weight	Pack.
	Type Code		76122712	[kg]	unit
UL locking device	S800U-PLL	2CCS800017R0001	15057	0.02	1

*High performance circuit breaker and lockout tag are not included in delivery

S800 Accessories



2CCC413045F0001



2CCC413046F0004



2CCC413057F0001



2CCC413058F0001



2CCC413059F0001



2CCC413377F0001

	Order details Type Code	Order code	GTIN EAN 76122712	Weight [kg]	Pack. unit
Interchangeable adapter kit					
Cage terminal	S800-CT2125	2CCS800900R0181	12049	0.03	2
Cage terminal	S800-CT4125	2CCS800900R0151	12032	0.06	4

	Order details Type Code	Order code	GTIN EAN 76122712	Weight [kg]	Pack. unit
Interchangeable adapter kit					
Ring terminal connection	S800-RT2125	2CCS800900R0161	08240	0.03	2
Ring terminal connection	S800-RT4125	2CCS800900R0131	08219	0.06	4

	Order details Type Code	Order code	GTIN EAN 76122712	Weight [kg]	Pack. unit
Busbar					
Busbar 250 A with 24 contacts pins, 3P	S803-BB250	2CCS800900R0071	08288	1.5	1

	Order details Type Code	Order code	GTIN EAN 76122714	Weight [kg]	Pack. unit
Busbar					
Busbar 250 A with 24 contacts pins, 3P+N	S804-BB250	2CCF019568R0001	41807	2	1
Busbar 250 A with 6 contacts pins, 3P	S803-BB6	2CCF019562R0001	41302	0.375	1

	Order details Type Code	Order code	GTIN EAN 76122712	Weight [kg]	Pack. unit
Feed block					
Feed block 120 mm ² 3P	S803-BBPC120	2CCS800900R0101	08301	0.46	1

	Order details Type Code	Order code	GTIN EAN 76122714	Weight [kg]	Pack. unit
Feed block					
Feed block 4p 120 mm ²	S804-BBPC120	2CCF019569R0001	41814	0.58	1

	Order details Type Code	Order code	GTIN EAN 76122712	Weight [kg]	Pack. unit
Contact-protection cover					
Contact-protection cover	S800-BBIC	2CCS800900R0081	08967	0.02	12

	Order details Type Code	Order code	GTIN EAN 76122712	Weight [kg]	Pack. unit
End cap					
End cap	S800-END	2CCS800900R0091	08295	0.04	10

	Order details Type Code	Order code	GTIN EAN 7612271	Weight [kg]	Pack. unit
Pole connector					
Pole connector 50 A	S802-LINK50	2CCS800900R0411	211295	0.03	10
Pole connector 125 A	S802-LINK125	2CCS800900R0562	419103	0.15	2

S800 Accessories

1

S800-ILS	Order details Type Code	Order code	GTIN EAN 76122712	Weight [kg]	Pack. unit
Identification labeling system 168 x 6 x 11.5 mm	S800-ILS	2CCS800900R0121	08271	0.01	1



2CCA81032F0001

Description	Order details Type code	Order code	GTIN EAN 7612271	Weight [kg]	Pack. unit
Sensors 18 mm for S800 installation devices with cage terminals					
80 A	CMS-100S8	2CCA880124R0001	426552	0.014	1
40 A	CMS-101S8	2CCA880125R0001	426569	0.014	1
20 A	CMS-102S8	2CCA880126R0001	426576	0.014	1



2CCA81034F0001

Sensors 25 mm for S800 installation devices with cage terminals					
Description	Order details Type code	Order code	GTIN EAN 7612271	Weight [kg]	Pack. unit
160 A	CMS-200S8	2CCA880136R0001	426644	0.028	1
80 A	CMS-201S8	2CCA880137R0001	426651	0.028	1
40 A	CMS-202S8	2CCA880138R0001	426668	0.028	1

Sensors 25 mm DIN-Rail mounting (universal use)

Description	Order details Type code	Order code	GTIN EAN 7612271	Weight [kg]	Pack. unit
160 A	CMS-200DR	2CCA880132R0001	426675	0.030	1
80 A	CMS-201DR	2CCA880133R0001	426682	0.030	1
40 A	CMS-202DR	2CCA880134R0001	426699	0.030	1

Sensors 25 mm for cable mounting (universal use)

Description	Order details Type code	Order code	GTIN EAN 7612271	Weight [kg]	Pack. unit
160 A	CMS-200CA	2CCA880117R0001	426705	0.026	1
80 A	CMS-201CA	2CCA880118R0001	426712	0.026	1
40 A	CMS-202CA	2CCA880119R0001	426729	0.026	1

Control Unit (24VDC)

Description	Order details Type code	Order code	GTIN EAN 7612271	Weight [kg]	Pack. unit
Modbus RTU	CMS-600	2CCA880000R0001	418700	0.153	1



2CCA81070F0001

Accessories

Description	Order details Type code	Order code	GTIN EAN 7612271	Weight [kg]	Pack. unit
Flat cable 2 m	CMS-800	2CCA880148R0001	419233	0.017	1
Flat cable 3 m	CMS-801	2CCA880149R0001	424428	0.025	1
Connector set	CMS-820	2CCA880145R0001	419240	0.024	35

S800 Accessories

Assignment of the FI protection devices

Type A	Type AC	Type AS	Type A-AP-R
Pulse current sensitive	Alternating current sensitive	Pulse current sensitive	Pulse current sensitive
FI protection device	FI protection device	FI protection device (selective)	FI protection device (short-time delay)



ZCC413051F001

Quantity	Rated current Pole	Order details Type Code	Type	I _{Δn}	Order	GTIN EAN	Weight [kg]	Pack. unit
2	63	DDA802AC-63/0.03	AC	0.03	2CSB802001R1630	2919704	0.3	1
2	63	DDA802AC-63/0.3	AC	0.3	2CSB802001R3630	2919902	0.3	1
2	63	DDA802A-63/0.03	A	0.03	2CSB802101R1630	2920007	0.3	1
2	63	DDA802A-63/0.3	A	0.3	2CSB802101R3630	2920205	0.3	1
2	63	DDA802A-63/0.5	A	0.5	2CSB802101R4630	2920403	0.3	1
2	63	DDA802AS-63/0.3	AS	0.3	2CSB802201R3630	2920601	0.3	1
2	63	DDA802AS-63/1	AS	1	2CSB802201R5630	2920809	0.3	1
2	63	DDA802A-63/0.03AP-R	A-AP-R	0.03	2CSB802401R1630	2921400	0.3	1
2	100	DDA802A-100/0.3	A	0.3	2CSB802101R3000	2545033	0.42	1
2	100	DDA802A-100/0.5	A	0.5	2CSB802101R4000	2542636	0.42	1
2	100	DDA802AS-100/0.3	AS	0.3	2CSB802201R3000	2542537	0.42	1
2	100	DDA802AS-100/1	AS	1	2CSB802201R5000	2547433	0.42	1
2	100	DDA802A-100/0.03AP-R	A-AP-R	0.03	2CSB802401R1000	2544630	0.42	1



ZCC413053F001

3	63	DDA803AC-63/0.03	AC	0.03	2CSB803001R1630	2922001	0.4	1
3	63	DDA803AC-63/0.3	AC	0.3	2CSB803001R3630	2922209	0.4	1
3	63	DDA803A-63/0.03	A	0.03	2CSB803101R1630	2922308	0.4	1
3	63	DDA803A-63/0.3	A	0.3	2CSB803101R3630	2922506	0.4	1
3	63	DDA803A-63/0.5	A	0.5	2CSB803101R4630	2922704	0.4	1
3	63	DDA803AS-63/0.3	AS	0.3	2CSB803201R3630	2922902	0.4	1
3	63	DDA803AS-63/1	AS	1	2CSB803201R5630	2923206	0.4	1
3	63	DDA803A-63/0.03AP-R	A-AP-R	0.03	2CSB803401R1630	2923800	0.4	1
3	100	DDA803A-100/0.3	A	0.3	2CSB803101R3000	2544135	0.64	1
3	100	DDA803A-100/0.5	A	0.5	2CSB803101R4000	2541738	0.64	1
3	100	DDA803AS-100/0.3	AS	0.3	2CSB803201R3000	2544838	0.64	1
3	100	DDA803AS-100/0.5	AS	0.5	2CSB803201R4000	2542438	0.64	1
3	100	DDA803AS-100/1	AS	1	2CSB803201R5000	2547334	0.64	1
3	100	DDA803A-100/0.03AP-R	A-AP-R	0.03	2CSB803401R1000	2542230	0.64	1

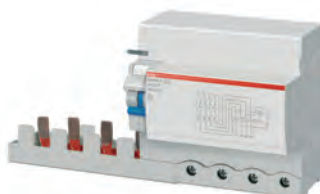

ZCC413054F001

4	63	DDA804AC-63/0.03	AC	0.03	2CSB804001R1630	2924401	0.46	1
4	63	DDA804AC-63/0.3	AC	0.3	2CSB804001R3630	2924609	0.46	1
4	63	DDA804A-63/0.03	A	0.03	2CSB804101R1630	2924807	0.46	1
4	63	DDA804A-63/0.3	A	0.3	2CSB804101R3630	2925002	0.46	1
4	63	DDA804A-63/0.5	A	0.5	2CSB804101R4630	2925200	0.46	1
4	63	DDA804AS-63/0.3	AS	0.3	2CSB804201R3630	2926207	0.46	1
4	63	DDA804AS-63/1	AS	1	2CSB804201R5630	2926504	0.46	1
4	63	DDA804A-63/0.03AP-R	A-AP-R	0.03	2CSB804401R1630	2927709	0.46	1
4	100	DDA804A-100/0.3	A	0.3	2CSB802101R3000	2545033	0.77	1
4	100	DDA804A-100/0.5	A	0.5	2CSB802101R4000	2542636	0.77	1
4	100	DDA804AS-100/0.3	AS	0.3	2CSB804201R3000	2544739	0.77	1
4	100	DDA804AS-100/0.5	AS	0.5	2CSB804201R4000	2542339	0.77	1
4	100	DDA804AS-100/1	AS	1	2CSB804201R5000	2547235	0.77	1
4	100	DDA804A-100/0.03AP-R	A-AP-R	0.03	2CSB804401R1000	2547136	0.77	1

S800 Accessories

1



2CCC41325F0001

Quantity	Rated current [A]	Order details Type Code	Type	$I_{\Delta n}$	Product number 2CC	GTIN EAN 76122712	Weight [kg]	Pack. unit
2	125	DS802S-B125/0.03AP-R	A-AP-R	0.03	B862004R0845	11301	0.79	1
2	125	DS802S-C125/0.03AP-R	A-AP-R	0.03	B862004R0844	11318	0.79	1
2	125	DS802S-D125/0.03AP-R	A-AP-R	0.03	B862004R0841	11325	0.79	1
2	125	DS802S-K125/0.03AP-R	A-AP-R	0.03	B862004R0647	11332	0.79	1
2	125	DS802N-B125/0.03AP-R	A-AP-R	0.03	B892004R0845	11424	0.79	1
2	125	DS802N-C125/0.03AP-R	A-AP-R	0.03	B892004R0844	11431	0.79	1
2	125	DS802N-D125/0.03AP-R	A-AP-R	0.03	B892004R0841	11448	0.79	1
2	125	DS802S-B125/1AS	AS	1	C862006R0845	11516	0.79	1
2	125	DS802S-C125/1AS	AS	1	C862006R0844	11523	0.79	1
2	125	DS802S-D125/1AS	AS	1	C862006R0841	11530	0.79	1
2	125	DS802S-K125/1AS	AS	1	C862006R0647	11547	0.79	1
2	125	DS802N-B125/1AS	AS	1	C892006R0845	11639	0.79	1
2	125	DS802N-C125/1AS	AS	1	C892006R0844	11646	0.79	1
2	125	DS802N-D125/1AS	AS	1	C892006R0841	11653	0.79	1
2	125	DS802S-B125/0.3A	A	0.3	A862005R0845	11721	0.79	1
2	125	DS802S-C125/0.3A	A	0.3	A862005R0844	11738	0.79	1
2	125	DS802S-D125/0.3A	A	0.3	A862005R0841	11745	0.79	1
2	125	DS802S-K125/0.3A	A	0.3	A862005R0647	11752	0.79	1
2	125	DS802N-B125/0.3A	A	0.3	A892005R0845	11844	0.79	1
2	125	DS802N-C125/0.3A	A	0.3	A892005R0844	11851	0.79	1
2	125	DS802N-D125/0.3A	A	0.3	A892005R0841	11868	0.79	1



2CCC41325R0001

3	125	DS803S-B125/0.03AP-R	A-AP-R	0.03	B863004R0845	11349	1.14	1
3	125	DS803S-C125/0.03AP-R	A-AP-R	0.03	B863004R0844	11356	1.14	1
3	125	DS803S-D125/0.03AP-R	A-AP-R	0.03	B863004R0841	11363	1.14	1
3	125	DS803S-K125/0.03AP-R	A-AP-R	0.03	B863004R0647	11370	1.14	1
3	125	DS803N-B125/0.03AP-R	A-AP-R	0.03	B893004R0845	11455	1.14	1
3	125	DS803N-C125/0.03AP-R	A-AP-R	0.03	B893004R0844	11462	1.14	1
3	125	DS803N-D125/0.03AP-R	A-AP-R	0.03	B893004R0841	11479	1.14	1
3	125	DS803S-B125/0.3A	A	0.3	A863005R0845	11769	1.14	1
3	125	DS803S-C125/0.3A	A	0.3	A863005R0844	11776	1.14	1
3	125	DS803S-D125/0.3A	A	0.3	A863005R0841	11783	1.14	1
3	125	DS803S-K125/0.3A	A	0.3	A863005R0647	11790	1.14	1
3	125	DS803N-B125/0.3A	A	0.3	A893005R0845	11875	1.14	1
3	125	DS803N-C125/0.3A	A	0.3	A893005R0844	11882	1.14	1
3	125	DS803N-D125/0.3A	A	0.3	A893005R0841	11899	1.14	1

S800 Accessories

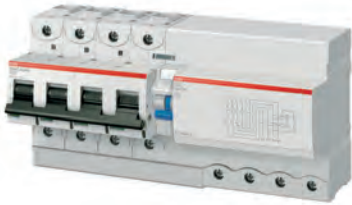

ZCCG413259F0001

Quantity	Rated current	Order details	Type	$I_{\Delta n}$	Product number	GTIN	Weight	Pack.
Pole	[A]	Type Code			ZCC	EAN 76122712	[kg]	unit
4	125	DS804S-B125/0.03AP-R	A-AP-R	0.03	B864004R0845	11387	1.44	1
4	125	DS804S-C125/0.03AP-R	A-AP-R	0.03	B864004R0844	11394	1.44	1
4	125	DS804S-D125/0.03AP-R	A-AP-R	0.03	B864004R0841	11400	1.44	1
4	125	DS804S-K125/0.03AP-R	A-AP-R	0.03	B864004R0647	11417	1.44	1
4	125	DS804N-B125/0.03AP-R	A-AP-R	0.03	B894004R0845	11486	1.44	1
4	125	DS804N-C125/0.03AP-R	A-AP-R	0.03	B894004R0844	11493	1.44	1
4	125	DS804N-D125/0.03AP-R	A-AP-R	0.03	B894004R0841	11509	1.44	1
4	125	DS804S-B125/0.3AS	AS	0.3	C864005R0845	11554	1.44	1
4	125	DS804S-C125/0.3AS	AS	0.3	C864005R0844	11561	1.44	1
4	125	DS804S-D125/0.3AS	AS	0.3	C864005R0841	11578	1.44	1
4	125	DS804S-K125/0.3AS	AS	0.3	C864005R0647	11585	1.44	1
4	125	DS804S-B125/1AS	AS	1	C864006R0845	11592	1.44	1
4	125	DS804S-C125/1AS	AS	1	C864006R0844	11608	1.44	1
4	125	DS804S-D125/1AS	AS	1	C864006R0841	11615	1.44	1
4	125	DS804S-K125/1AS	AS	1	C864006R0647	11622	1.44	1
4	125	DS804N-B125/0.3AS	AS	0.3	C894005R0845	11660	1.44	1
4	125	DS804N-C125/0.3AS	AS	0.3	C894005R0844	11677	1.44	1
4	125	DS804N-D125/0.3AS	AS	0.3	C894005R0841	11684	1.44	1
4	125	DS804N-B125/1AS	AS	1	C894006R0845	11691	1.44	1
4	125	DS804N-C125/1AS	AS	1	C894006R0844	11707	1.44	1
4	125	DS804N-D125/1AS	AS	1	C894006R0841	11714	1.44	1
4	125	DS804S-B125/0.3A	A	0.3	A864005R0845	11806	1.44	1
4	125	DS804S-C125/0.3A	A	0.3	A864005R0844	11813	1.44	1
4	125	DS804S-D125/0.3A	A	0.3	A864005R0841	11820	1.44	1
4	125	DS804S-K125/0.3A	A	0.3	A864005R0647	11837	1.44	1
4	125	DS804N-B125/0.3A	A	0.3	A894005R0845	11905	1.44	1
4	125	DS804N-C125/0.3A	A	0.3	A894005R0844	11912	1.44	1
4	125	DS804N-D125/0.3A	A	0.3	A894005R0841	11929	1.44	1



Table of content S800

Properties of main devices S800

Characteristics	2/2
Special features of S800	2/8

Properties of S800 accessories

S800-AUX	2/20
S800-AUX/ALT	2/20
S800-NT	2/21
S800-RSU	2/21
S800-RSU-CP	2/22
S800-RSU-P	2/22
S800-SOR	2/22
S800-UVR	2/22
S803S-SCL	2/22
S800-SCL-SR	2/23
S800-RD	2/24
S800-IP9	2/24
S800-PLL	2/24
S800U-PLL	2/25
S800-CT, -RT	2/25
S800-ILS	2/25
S802-LINK50/-LINK125	2/25
DDA800	2/26
S800 Busbar system	2/26
Unifix H	2/26

High Performance MCB S800

Characteristics of the S and N series

Characteristics

2

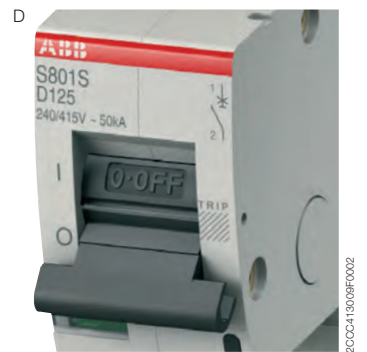
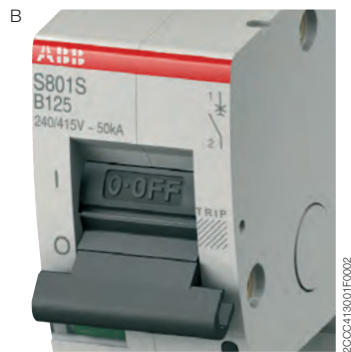

Tripping characteristic B

Thermal tripping 1.13 ... 1.3 x I_n
 Electromagnetic tripping
 3 ... 5 x I_n AC
 Reference temperature 30 °C

As circuit breaker for electric circuits feeding consumers that do not generate any current peaks, or only mild ones (boilers, electric heaters, cooking stoves).

Tripping characteristic C

Thermal tripping 1.13 ... 1.3 x I_n
 Electromagnetic tripping
 5 ... 10 x I_n AC
 Reference temperature 30 °C

As "standard" MCB for electric circuits feeding consumers that generate current peaks normal within inductive devices (fluorescent tubes, electric discharge lamps) as well as for circuits within sockets in commercially used systems/plants.

Tripping characteristic D

Thermal tripping 1.13 ... 1.3 · I_n
 Electromagnetic tripping
 10 ... 20 x I_n AC
 Reference temperature 30 °C

As main circuit breaker for electric circuits feeding consumers that generate extremely high current peaks (transformers, capacitor banks). As main circuit breaker connected upstream of other circuit breakers (reference over-current circuit breaker).

Tripping characteristics

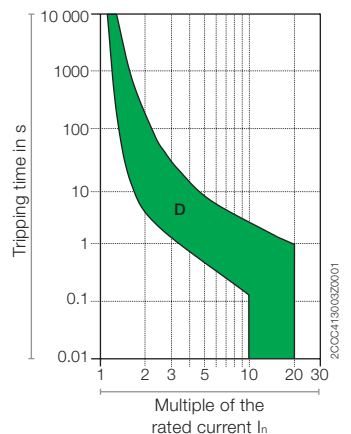
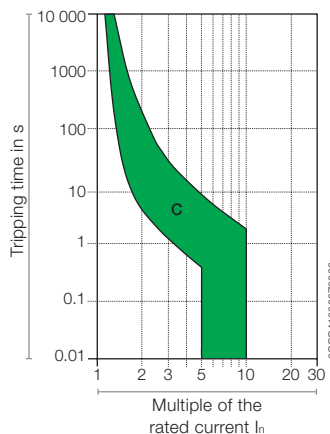
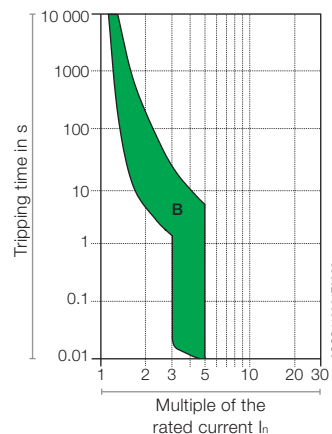

Tripping behaviour compliant to EN 60898-1

Characteristics	Currents	Thermal tripping		Electromagnetic tripping	
		Small test current	Large test current	Small test current	Large test current
B	10 ... 80 A	1.13 x I _n	1.45 x I _n	3 x I _n	5 x I _n
C	10 ... 80 A	1.13 x I _n	1.45 x I _n	5 x I _n	10 x I _n
D	10 ... 80 A	1.13 x I _n	1.45 x I _n	10 x I _n	20 x I _n

* applies exclusively to the S series.



Tripping characteristic K

Thermal tripping 1.05 ... 1.2 x I_n
 Electromagnetic tripping 13 x I_n AC
 Reference temperature 40°C

Tripping characteristic UCB

Thermal tripping 1.05 ... 1.3 x I_n
 Electromagnetic tripping 6 x I_n DC
 Reference temperature 30°C

Tripping characteristic UCK

Thermal tripping 1.05 ... 1.2 x I_n
 Electromagnetic tripping 11 x I_n DC
 Reference temperature 40°C

Serves as High Performance MCB in case of high magnetic inrush currents that occur, e.g. in engines or transformers. This characteristic provides the best protection for a wide range of electrical systems by allowing high inrush currents when starting up the system.

Device protection independent of polarity within DC plants up to 750 V = at a time constant of ≤15 ms.

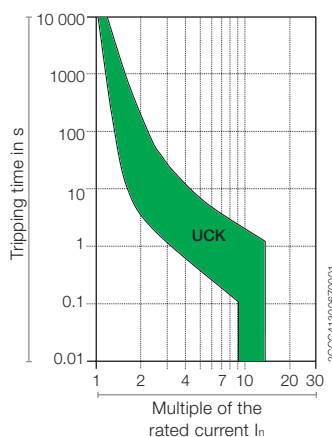
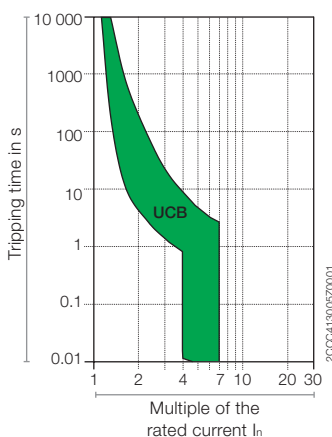
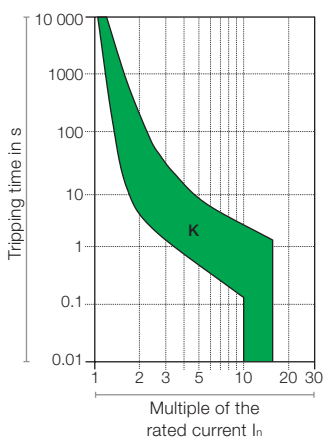

Tripping behaviour compliant to IEC 60947-2

Characteristics	Currents	Thermal tripping		Electromagnetic tripping
		Small test current	Large test current	
B	6 ... 125 A	1.05 x I _n	1.30 x I _n	4 x I _n ± 20%
C	6 ... 125 A	1.05 x I _n	1.30 x I _n	8 x I _n ± 20%
D	6 ... 125 A	1.05 x I _n	1.30 x I _n	13 x I _n ± 20%
*K	6 ... 125 A	1.05 x I _n	1.20 x I _n	13 x I _n ± 20%
*KM	10 ... 80 A			13 x I _n ± 20%
*UCB	10 ... 125 A	1.05 x I _n	1.30 x I _n	6 x I _n ± 20% (DC)
*UCK	10 ... 125 A	1.05 x I _n	1.20 x I _n	11 x I _n ± 20% (DC)

High Performance MCB S800

Characteristics of the B and C series

Characteristics

2

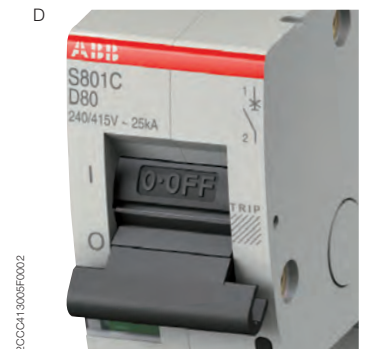
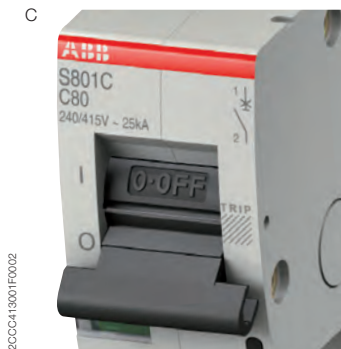
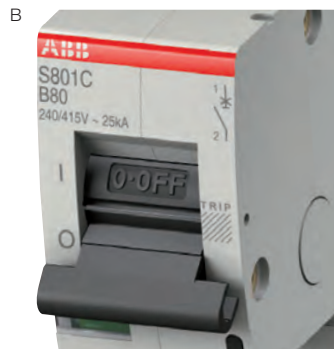

Tripping characteristic B

Thermal tripping 1.13 ... 1.3 x I_n
 Electromagnetic tripping
 3 ... 5 x I_n AC
 Reference temperature 30 °C

As circuit breaker for electric circuits feeding consumers that do not generate any current peaks, or only mild ones (boilers, electric heaters, cooking stoves).

Tripping characteristic C

Thermal tripping 1.13 ... 1.3 x I_n
 Electromagnetic tripping
 5 ... 10 x I_n AC
 Reference temperature 30 °C

As "standard" MCB for electric circuits feeding consumers that generate current peaks normal within inductive devices (fluorescent tubes, electric discharge lamps) as well as for circuits within sockets in commercially used systems/plants.

Tripping characteristic D

Thermal tripping 1.13 ... 1.3 x I_n
 Electromagnetic tripping
 10 ... 20 x I_n AC
 Reference temperature 30 °C

As main circuit breaker for electric circuits feeding consumers that generate extremely high current peaks (transformers, capacitor banks).
 As main circuit breaker connected upstream of other circuit breakers (reference over-current circuit breaker).

Tripping characteristics

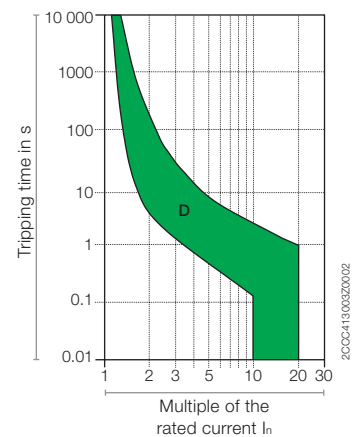
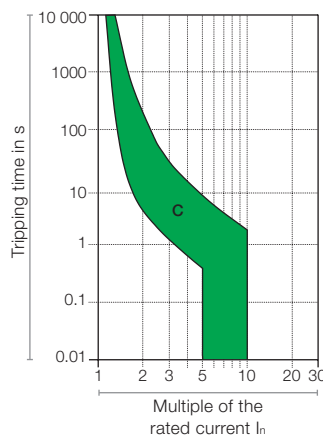
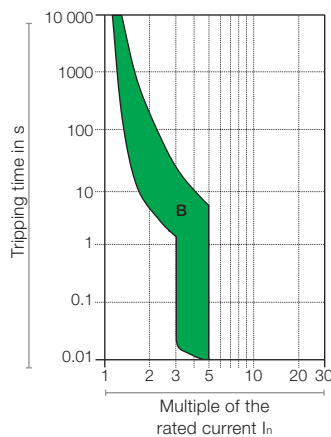

Tripping behaviour compliant to 60898-1 (apply for S800C only)

Characteristics	Currents	Thermal tripping		Electromagnetic tripping	
		Small test current	Large test current	Small test current	Large test current
B	10 ... 125 A	1.13 x I _n	1.45 x I _n	3 x I _n	5 x I _n
C	10 ... 125 A	1.13 x I _n	1.45 x I _n	5 x I _n	10 x I _n
D	10 ... 100 A	1.13 x I _n	1.45 x I _n	10 x I _n	20 x I _n



Tripping characteristic K

Thermal tripping 1.05 ... 1.2 x I_n
 Electromagnetic tripping 13 x I_n AC
 Reference temperature 40°C

Serves as High Performance MCB in case of high magnetic inrush currents that occur, e.g. in engines or transformers. This characteristic provides the best protection for a wide range of electrical systems by allowing high inrush currents when starting up the system.

Tripping behaviour compliant to IEC 60947-2

Characteristics	Currents	Thermal tripping		Electromagnetic tripping
		Small test current	Large test current	
B	10/32* ... 125A	1.05 x I _n	1.30 x I _n	4 x I _n ± 20%
C	10/32* ... 125A	1.05 x I _n	1.30 x I _n	8 x I _n ± 20%
D	10/32* ... 125A	1.05 x I _n	1.30 x I _n	13 x I _n ± 20%
K	10/32* ... 125A	1.05 x I _n	1.20 x I _n	13 x I _n ± 20%

* applies for S800B

High Performance MCB S800 Characteristics of the U series

Characteristics

2

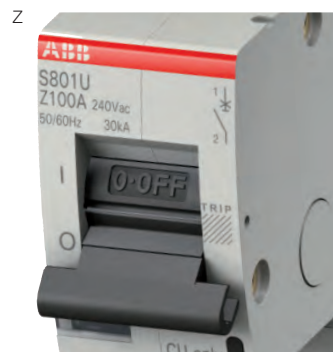

Tripping characteristic Z

Thermal tripping 1.00 ... 1.35 x I_n
Electromagnetic tripping
4 x I_n AC
Reference temperature 25 °C

As miniature circuit breaker for electric circuits feeding consumers that do not generate any current peaks, or only mild ones.

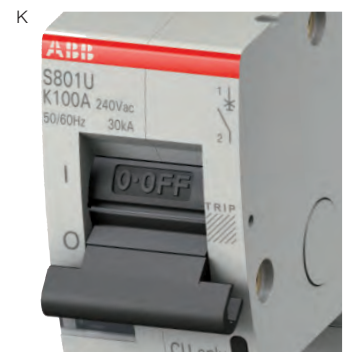

Tripping characteristic K

Thermal tripping 1.00 ... 1.35 x I_n
Electromagnetic tripping
13 x I_n AC
Reference temperature 25 °C

Serves as High Performance MCB in case of high magnetic inrush currents that occur, e.g. in engines or transformers. This characteristic provides the best protection for a wide range of electrical systems by allowing high inrush currents when starting up the system.

Tripping characteristics

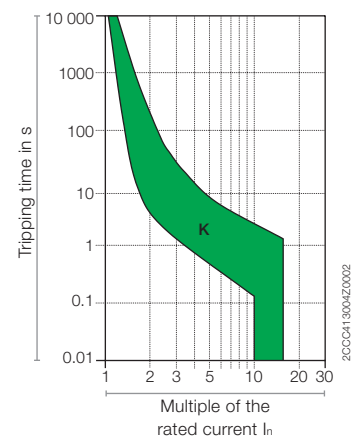
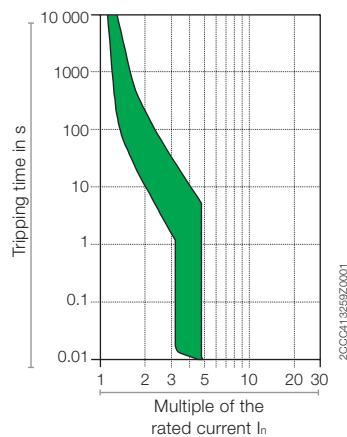

Tripping behaviour compliant to UL 489

Characteristics	Currents	Thermal tripping		Electromagnetic tripping
		Small test current	Large test current	
Z	10 ... 100A	1.00 x I _n	1.35 x I _n	4 x I _n ± 20%
K	10 ... 100A	1.00 x I _n	1.35 x I _n	13 x I _n ± 20%

High Performance MCB S800

Characteristics of the S804U-UCZ, S804U-PVS5

Characteristics



Tripping characteristic

Thermal tripping 1.00 ... 1.35 x I_n
 Electromagnetic tripping 11 x I_n
 Reference temperature 25 °C

As circuit breaker for voltages up to 600 VDC. especially in datacenters.



Tripping characteristic

Thermal tripping 1.13 ... 1.3 x I_n
 Electromagnetic tripping 6 x I_n
 Reference temperature 50 °C

As Ground-Fault Detector Interrupter (GFDI) in photovoltaic systems.

Tripping characteristics

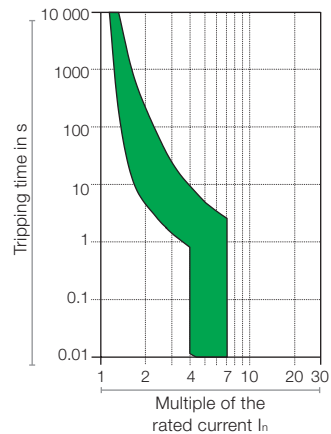
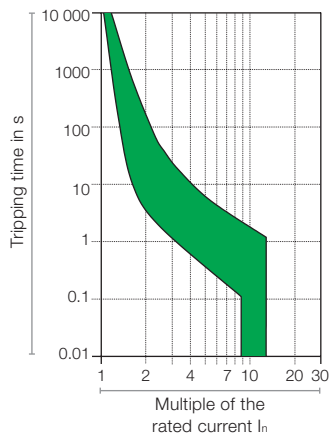

Tripping behaviour compliant to UL 489B

Characteristics	Currents	Thermal tripping		Electromagnetic tripping
		Small test current	Large test current	
PVS	5A	1.13 x I _n	1.30 x I _n	6 x I _n (DC)

Tripping behaviour compliant to UL 489

Characteristics	Currents	Thermal tripping		Electromagnetic tripping
		Small test current	Large test current	
Z	10 ... 80A	1.00 x I _n	1.35 x I _n	11 x I _n (DC) ± 20%

Photovoltaic High Performance MCB Characteristic of the S800PV-S

Characteristics

2



Tripping characteristic

Thermal tripping $1.05 \dots 1.3 \times I_n$

Electromagnetic tripping $6 \times I_n$

Reference temperature 30°C

DC protection independent of polarity in photovoltaic plants up to 1200VDC at a time constant $\leq 5 \text{ ms}$.

Tripping characteristics

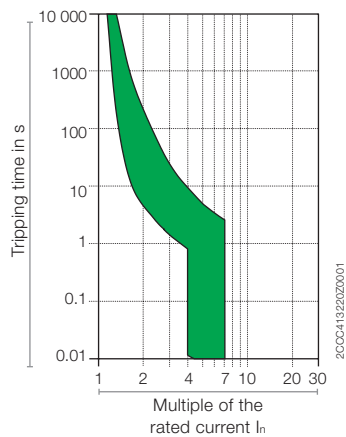

Tripping behaviour compliant to IEC 60947-2

Characteristics	Currents	Thermal tripping		Electromagnetic tripping
		Small test current	Large test current	
PV-S	10 ... 125A	$1.05 \times I_n$	$1.30 \times I_n$	$6 \times I_n$ (DC)

Properties

Special features of S800



20CC04130001F0002

The S800S, -N, -C, -B and -HV high performance MCBs: safe innovation

The S800 high performance MCB limits energy and current in case of a short-circuit power cut off.

The specially designed double arcing chamber system, i. e. per pole are two arcing chambers, ensures excellent operating characteristics. The new S800B has only one arcing chamber. Additional exceptional features of the S800 series are:

- Convincing:** Selectivity to upstream overcurrent protection devices due to a total switch-off time of only ≤ 2.5 ms.
- Safe:** Excellent backup protection by limiting the energy to a value $\leq 100\,000\text{ A}^2\text{s}$ (125A/50kA). In case of short-circuit, there is a low load to the circuit and the location of the damage due to the high limitation of the let-through energy.
- Loads:** Up to 125A rated current
- Checked:**
 - S series** up to 50kA rated ultimate short-circuit breaking capacity I_{cu}
 - N series** up to 36kA rated ultimate short-circuit breaking capacity I_{cu}
 - C series** up to 25kA rated ultimate short-circuit breaking capacity I_{cu}
 - B series** up to 16kA rated ultimate short-circuit breaking capacity I_{cu}
 - HV series** up to 4kA rated ultimate short-circuit breaking capacity I_{cu}
- Selectable:** Characteristics:
 - S series: B, C, D, K, KM, UCB, UCK
 - N series: B, C, D
 - C series: B, C, D, K
 - B series: B, C, D, K
 - HV series: K
- Compact:** Slight 27 mm width per pole
- Flexible:** Accessories installed by the customer.



S800U: Highest safety now also ensured for UL applications

- Convincing:** Covering of different voltage ranges (240 VAC, 600 VDC, 1000 VDC)
- Safe:** Excellent backup protection due to limitation of energy.
- Loads:** Up to 100 A rated current
- Checked:**
 - K-, Z series** up to 50kA breaking capacity
 - UCZ series** up to 10kA breaking capacity
 - PVS series** up to 3kA breaking capacity
- Selectable:** Characteristics:
 - K, Z, UCZ, PVS
- Compact:** Smallest sizes.
- Flexible:** Accessories installed by the customer.
- Standards:** UL489, UL489B, IEC 60947-2

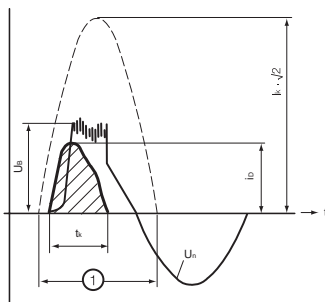

20CC0413194Z0002

1 sinus half-wave
50Hz $\Delta T/2 = 10$ ms

Short description

Two triggers detect overcurrents, effect the switching station and provide short-circuit protection.

1. The thermal trip for overload protection with time delay.
2. The electromagnetic fast-acting trip with concrete anchor for short-circuit protection.

- $I_k \times \sqrt{2}$ peak value of the prospective short-circuit current
- I_d max. let-through current of the S800 high performance MCB
- U_n supply voltage
- U_B build up and collapse of the arc voltage
- t_k Turn-off time of S800 high performance MCB

Properties

Special features of S800

2



2CCC413041F0002

Play it safe: display the operational state

The mechanical drive of the S800 high performance MCB is equipped with a trip-free release. It therefore switches independent of the actuating force or speed on the actuating lever. The trip position display thereby always reliably displays the exact position of the moving contact. The trip position provides additional trip detection allowing you to easily find the reason for the cut-off. Because the switch lever moves to the middle position in case of thermal or magnetic tripping, the user sees at a glance that this is an error state and can then initiate suitable measures.

*Middle position of switch lever, see picture

Reliable: the disconnecter properties

In OFF position (0 position), the S800 high performance MCB guarantees safe electrical isolation of the circuit compliant to IEC 60947-2.

Flexible: the installation

The S800 high performance MCB can be directly mounted onto any position on the DIN mounting rail without any impairment to its characteristics. Because the pole dimensions are identical for all rated currents, installation in switching systems is simplified.

The S800 can be installed in different ways:

- together with other breakers in the same DIN rail horizontally or vertically
- as an individual breaker in a single fixed compartment where the breaker is switched on/off with a rotary handle from the door, and the breaker is mounted on the wall of the panel
- as an individual breaker in a single withdrawable module, when requirements for high availability in the installation are a must

Cage and ring terminals

When ordering you can choose between cage terminals or ring terminal connectors. No matter which type you select, both connection options guarantee a high degree of reliability.



2CCC413038F0002

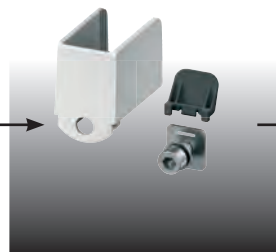

2CCC413046F0004



2CCC413038F0004

Doesn't let go: the replaceable terminal adapter*

The S800 standard equipment with interchangeable terminal adapter for wires, cables and rigid conductors guarantees a high level of flexibility and comfort. Fast and safe connection of the conductors is ensured by the "onboard terminal shutter" integrated into the body of the terminal, thereby preventing incorrect underclamping of the connections.

* Available for the S, N, C, U and PV series.



Extra safe: Fire protection acc. to NF F 16-101 and NF F 16-102 (prEN45545-2)

The S800 high performance MCB provides standard compliance to the requirements of Standard prEN45545-2 (Railway applications – Fire Protection on railway vehicles – Part 2: Requirements for fire behaviour of materials and components). This standard is based on the French standard NF F 16-101/ NF F 16-102 and makes new requirements of the fire behaviour of the materials used. The main focus of attention with relation to fire protection is on the following:

- Flame spread
- Rate of heat release
- Smoke development
- Toxicity

The S800 high performance automatic meets the following classification compliant to NF F 16-101 and NF F 16-102:

- I3F2
 - I3 no permanent flame at 850 °C
 - F2 index of fume density and toxicity ≤ 40

More information regarding the use of S800 breakers in rolling stock applications is available in the Technical catalogue ‘DIN-Rail components for rolling stock applications 2CDC002053D0204’



Elevation

Up to 2000 meters above sea level, the rated characteristics of the S800 high performance MCB remain unchanged. With increasing height, the properties of the atmosphere change regarding composition, dielectricity, the cooling capacity and the pressure. Thus for altitudes over 2000m below values are valid.

Elevation	[m]	2000	3000	4000	5000
Rated impulse withstand voltage U_{imp}	[kV]	8	6	6	6
Rated operational voltage U_e	[V]	690	600	540	470
Max. rated current I_n	[A]	1 x I_n	0.96 x I_n	0.93 x I_n	0.9 x I_n

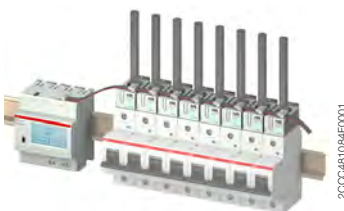

CMS – Current Measurement System

The CMS is a multichannel current measurement system for branch monitoring of alternating (AC) and direct (DC) currents up to 160A. Various sensor types allow the mounting in every installation environment.

Companies are dependent on the trouble-free operation of their electrical systems. Monitoring every branch circuit of an installation with the CMS enables to detect deviations quickly before serious damage is caused. Furthermore branch monitoring gives the maximum transparency on where and how the electricity is used. It allows an effective energy management in order to save costs and to assign them fairly.

Up to 64 sensors can be connected to each Control Unit. The sensors measure root mean square values (AC/DC currents) (actual, min/max, hold values) and transmit their measurement data via the flat cable to the Control Unit. The measured values are displayed locally on the Control Unit’s touch display and can be queried remotely by an RS485 Modbus connection.

Properties

DC Performance



20CC413223F0001

S800S-UC: The first choice as DC high performance MCB

The S800S-UC DC high performance MCB is in a wide range of DC applications at home. Due to their high rated operational voltage of up to 750VDC the max. rated current of 125A and the high breaking capacity of up to 50kA, make these devices suitable for applications, e.g.:

- DC track
- Galavanic applications
- Photovoltaics

S800S, N, and C: Up to 125VDC on each pole

The AC range is also an interesting choice for DC applications up to 125VDC per pole.

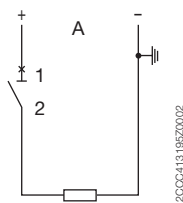

20CC413196Z0002

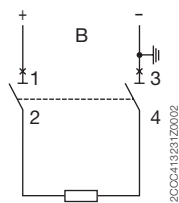

20CC413201Z0002

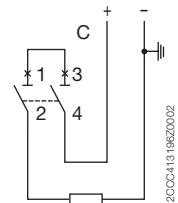

20CC413196Z0002

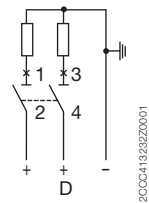

20CC41322Z0001

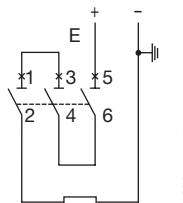

20CC413197Z0002

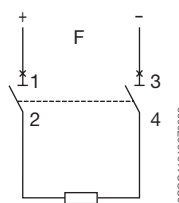

20CC413199Z0002

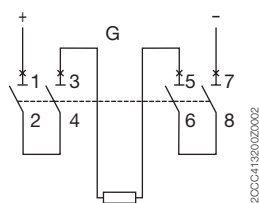

20CC413200Z0002

S800S-UC

Graphic	Short-circuit between output terminals	Contact to ground between output terminals and - earth
A	250 VDC	250 VDC
B	500 VDC	250 VDC
C	500 VDC	500 VDC
D	250 VDC	250 VDC
E	750 VDC	750 VDC
F	500 VDC	250 VDC (double failure)
G	750 VDC	500 VDC (double failure)

S800S, S800N, S800C

Graphic	Short-circuit between output terminals	Contact to ground between output terminals and -
A	125 VDC	125 VDC
B	250 VDC	125 VDC
C	250 VDC	250 VDC
D	125 VDC	125 VDC
E	375 VDC	375 VDC
F	250 VDC	125 VDC (double failure)
G	500 VDC	125 VDC (double failure)

Properties

Special features of S800PV-SP, S800PV-SD



2CCC413246FD001

String protection with S800PV-SP

A large proportion of the costs for photovoltaic systems is tied up in the equipment for the DC generation. The S800PV-SP protects these investments in the event of a fault.

- Convincing:** Suitable for up to 1500 VDC
- Loadable:** String protection up to 125 A
Reliable protection at high ambient temperatures
- Tested:** Rated ultimate short-circuit breaking capacity I_{cu} of 5 kA in accordance with IEC 60947-2 and Annex P
- Fast:** Reclosable for minimum standstill times
- Safe:** Disconnecter properties, switching under load
- Flexible:** Extensive range of accessories for remote shutdown and fault signalling



2CCC413379FD001

System isolation with S800PV-SD

The use of a DC isolator can be implemented reliably and in the minimum of space. Either you can choose the pole-independent S800PV-SD. The S800PV-SD is available as 2-, 3- and 4-pole version up to 1500 V DC.

- Convincing:** Suitable for up to 1500 VDC
- Loadable:** System isolation up to 125 A
No change in operating behaviour up to 60°C ambient temperature
Reliable switching of ohmic loads including moderate overloads
- Compact:** Minimum dimensions with maximum efficiency
- Tested:** Short-time withstand current I_{cw} of 1.5 kA in accordance with IEC 60947-3
- Safe:** Disconnecter properties, switching under load



2CCC413261FD001

Maximum device voltages

S800PV-SP	2-pole	3-pole	4-pole
I_e 100, 125 A	800 VDC	1200 VDC	1500 VDC

S800PV-SD	2-pole	3-pole	4-pole
I_e 32, 63, 125 A	800 VDC	1200 VDC	1500 VDC

ABB recommends to fulfill national and/or international standards as e. g. IEC 61439-1 Low-voltage switchgear and controlgear assemblies

Exemplary circuit diagrams

Earthed network $\leq 80 A$

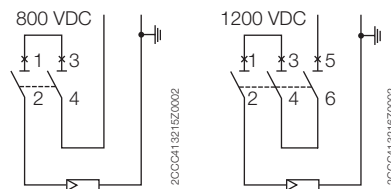

100, 125 A

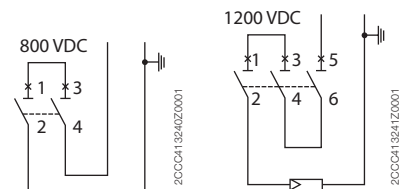

Non-earthed network

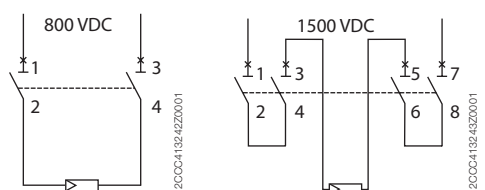
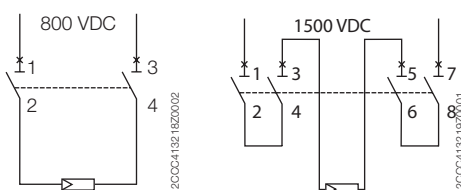

S804U-PVS5 High performance MCB for GFDI

2



2000413374F0001

GFDI = Ground Fault Detector Interrupter

The S804U-PVS5 is for GFDI application (Ground-Fault Detector Interrupter) in photovoltaic systems, with rated current 5 A and short-circuit current rating of 3 kA. The breaker is tested acc. to UL489B for 1000VDC.

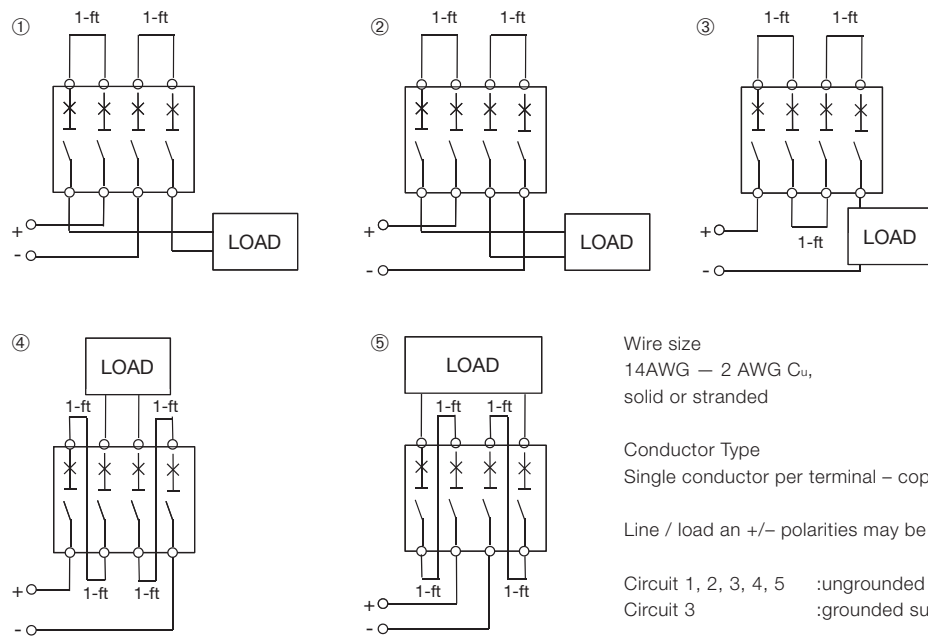

Wire size
14AWG – 2 AWG Cu,
solid or stranded

Conductor Type
Single conductor per terminal – copper only, 75C wire

Line / load an +/- polarities may be reversed

Circuit 1, 2, 3, 4, 5 : ungrounded supplies
Circuit 3 : grounded supplies

Properties

Special features of S800-RSU



2ACC0413353F0001

S800 with S800-RSU

Known for its outstanding short circuit capacities of up to 50 kA and voltages of up to 690 VAC and 1200 VDC, S800 has become a convenient solution for the DIN Rail.

S800-RSU makes the use of S800 even more convenient: driven by a brushless high precision DC motor, S800-RSU ensures fast remote-controlled operation. Wiring and operation is easy: S800-RSU can be operated with standard MDRC pushbuttons and indicator lights or via programmable logic controllers (PLCs). Due to its low power consumption, compact power supply units can be chosen.

Applications and Benefits:

Photovoltaics: Remote-controlled string management and convenient GFDI solutions

For a new generation of combiner boxes: used as a substitute for string or array fuses, S800PV or S804U-PVS5 in combination with S800-RSU ensures maximum PV yield due to minimum downtimes in case of failure or maintenance. For selective string management, additional switch disconnectors are no longer needed. S800-RSU adds to S800PV or S804U-PVS5 outstanding benefits for the PV-industry, allowing automated ground fault detection and interruption applications following UL1741.

Critical Power: Uninterrupted Power Supply Units

Fast, reliable backup protection for UPS systems: S800-RSU and S500-RSU provide outstanding quality and performance by switching a backup system quickly and reliably at extremely low stand-by current.

Telecommunications: Remote transmitter substations

The Remote Switching Units RSU minimize time-consuming visits to remote substations. Downtimes can be kept low due to convenient remote resetting of a tripped High Performance MCB.

Wind Power: Turbine towers

Inaccessible areas like wind turbine towers require immediate action in the case of overload or short circuits. The automatic switching capability of the High Performance MCB leads to reduction of cost-intensive fuse replacement or manual resetting of circuit breakers.

Product Facts:

- Driven by Swiss-made brushless high precision DC motors
- Field mountable on any multi-pole S800 High Performance MCB
- Almost all accessories can be mounted
- Short switching times and low power consumption
- Mechanically lockable
- Compatible to ABB pro M compact 9 mm pushbuttons and indicator lights
- Compatible to ABB Programmable Logic Controllers
- User safety due to hand-switching recognition
- Low stand-by current
- Connecting has to be done by a 10-pole Micro Fit 3.0 plug (not included in delivery)
- Two versions
 - S800-RSU-H IEC-Version according to IEC 60947-2
 - S800W-RSU World version according to IEC 60947-2 and UL489



Winner 2010 in the category Photovoltaics

Properties

Special features of S800S-SCL-SR

2



2CC041202BF0001

Group protection

In comparison to other short-circuit limiter you need only one S800S-SCL-SR for several motor starters or high performance miniature circuit breakers. With the requirement that the rated current of the short-circuit limiter does not exceed the total sum of the rated S800S currents of all downstream motor starters or circuit breakers. Furthermore the sum of all load currents including inrush currents shall not exceed the maximum permissible load of the S800S-SCL-SR. Therefore the main application of the new S800S-SCL-SR is group protection. Several downstream motor protection combinations or several high performance miniature circuit breakers can be protected with only one S800S-SCL-SR.

Single-line protection

For single-line protection we recommend to use the standard short-circuit limiter S803S-SCL. It has a toggle and will trip in case of a failure.

Current continuity

In case of a failure by using the S800S-SCL-SR as group protection only the defective device will trip; all other devices will keep doing their work.

Therefore you will have a very low breakdown, because only one motor will stop and not all of them.



2CC0413364F0001

Maximum system availability is given.

Schematic examples for rated currents up to 100 A

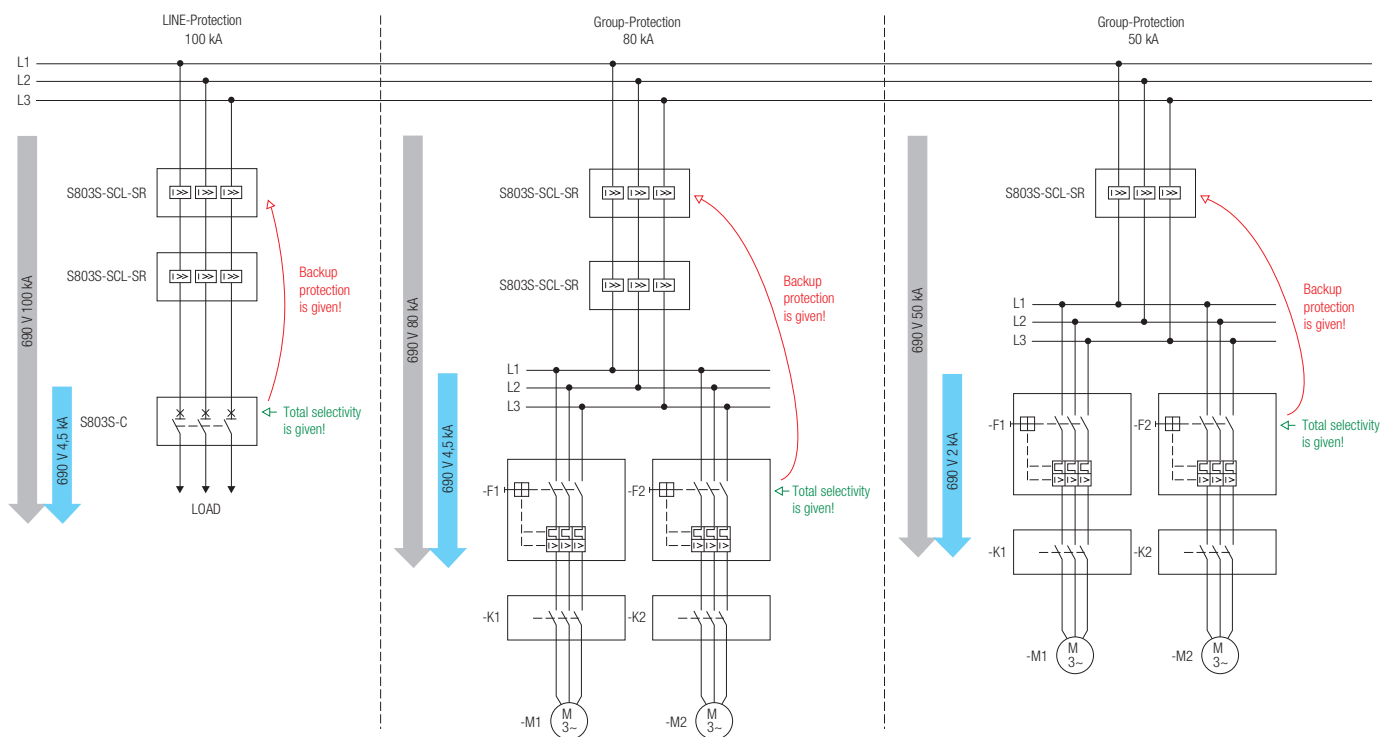

Short-circuit breaking capacity only downstream device
 Short-circuit breaking capacity coordinated group S800S-SCL-SR

Properties

Special features of S800HV-SCL-SR

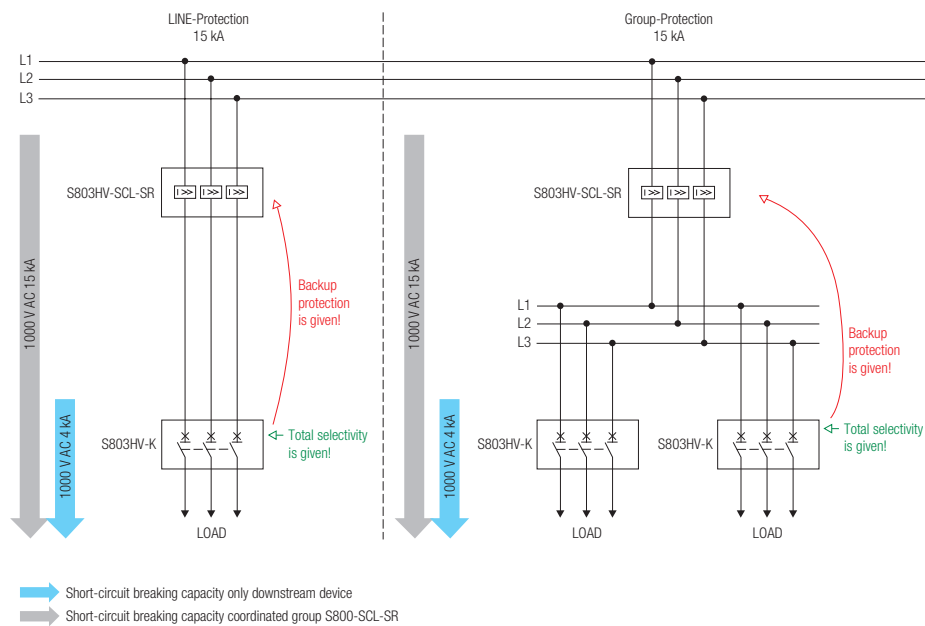

Properties

International device releases

2

Unique: Conformity to standards and quality assurance

Both the S800 high performance MCB as well as its accessories comply to international standards EN/IEC 60898-1, IEC 60947-2 and UL 489. Conformity to the above-mentioned product standards and guidelines are certified by the electrosuisse, a member of the IECEE and the Underwrites Laboratories Inc. The quality assurance system of ABB Switzerland Ltd. Low Voltage Products complies to the international standard ISO 9001:2000. The efforts of ISO14001-certified ABB Switzerland Ltd. Low Voltage Products within the field of environmental protection are not only limited to compliance to international standards; we are also engaged and active of our own accord in protecting the environment – and for achieving the targets of reduction in CO₂ emissions we have received as confirmation the EnAW label of the economic energy agency. To retain this label, an independent check is made every two years.

We are committed to a holistic approach in the reduction of environmental pollution. Among other things, this is manifested in our choice of non-toxic plastics, recyclable packaging material and environmentally sound handling of resources.



Approvals

Properties Accessories

Electrical properties

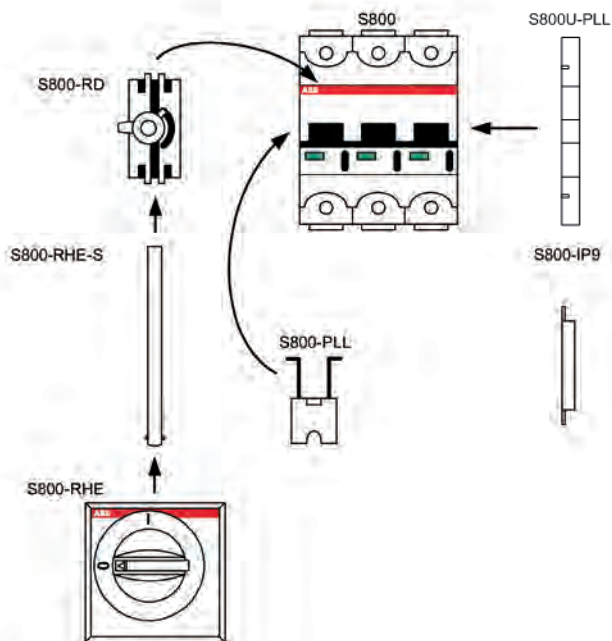
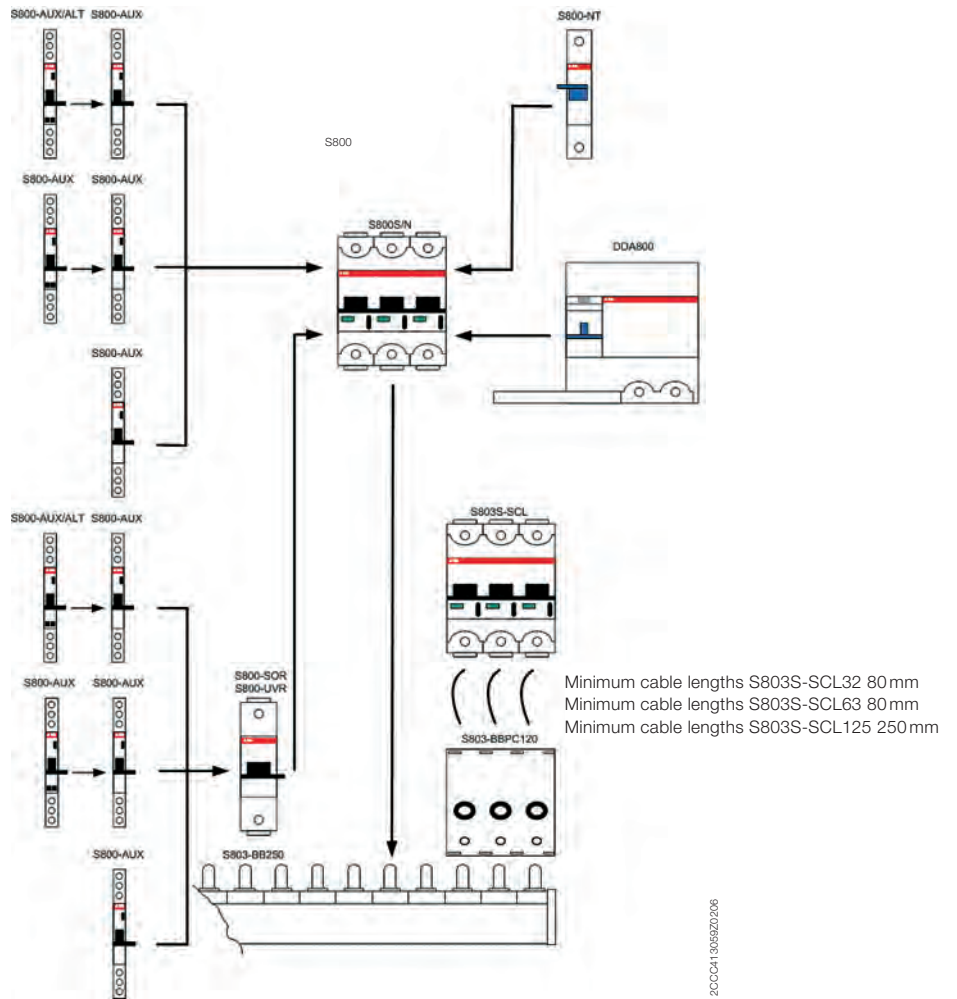



20CC413069F0001

S800-AUX

Auxiliary contact for external display

The S800-AUX auxiliary contact is for electrical display of the operating state of the high performance MCB. Both changeover contacts always switch simultaneously with the live conductor contact and detect the following operating states:

- Manual tripping
- Tripping due to thermal overload
- Tripping due to magnetic overload (short-circuit)

Mode of function of the test button

The test button is operated by a tool and allows the user to simulate the mode of function of the auxiliary contact when switched on without tripping the high performance MCB itself.

Mode of function of the two changeover contacts

- Off position of the high performance MCB contacts 11–12 and 21–22 closed
- On position of the high performance MCB contacts 11–14 und 21–24 closed

Mounting ability of the auxiliary contact

- Two S800-AUX auxiliary contacts can be mounted by the user at the left on the high performance MCB.



20CC413070F0001

S800-AUX/ALT

Combined auxiliary and signal contact for the external display

The S800-AUX/ALT combined auxiliary and signal contact is used for electrical signaling of the operating state of the high performance MCB.

The **AUX** auxiliary contact always switches simultaneously with the live conductor contact and detect the following forms of tripping:

- Manual switch on/off
- Tripping due to thermal overload
- Tripping due to magnetic overload (short-circuit)
- Tripping by S800-SOR or S800-UVR

The **ALT** signal contact detects the following forms of tripping of the high performance MCB:

- Tripping due to thermal overload
- Tripping due to magnetic overload (short-circuit)
- Tripping by S800-SOR or S800-UVR

Mode of function of the test button

The test button is operated by a tool and allows the user to simulate the mode of function of the combined auxiliary and signal contact when switched on without tripping the high performance MCB itself.

Mode of function of the ALT reset button

The reset button, which can be used at will, resets the **ALT** signal contact after a tripping. The high performance MCB is switched on independent of the state of the **ALT** signal contact.

Mode of function of the AUX changeover contact

- Off position of the high performance MCB Contact 11–12 closed
- On position of the high performance MCB Contact 11–14 closed

Mode of function of the ALT changeover contact

- No ALT tripping Contact 95–96 closed
- ALT tripping Contact 95–98 closed



20CC0413365F0001

S800-NT
Disconnectable neutral conductor 63 A

The S800 high performance MCB is force-opened before actuating the disconnectable neutral conductor S800-NT.

Mounting ability of the S800-NT neutral conductor

- The neutral conductor can be mounted by the user at the right on the high performance MCB.



20CC0413365F0001

S800-RSU-H IEC version
S800W-RSU World version
Remote Switching Units for High Performance MCB

The S800-RSU makes the use of S800 even more convenient. Driven by a brushless high precision DC motor, S800-RSU ensures fast remote-controlled operation.

Mounting ability

The S800-RSU is mountable on any multipole S800 High Performance MCB. Wiring and operation is feasible on field. The connection has to be done by a 10-pole Micro Fit 3.0 (not included in delivery). S800-RSU operated with standard MDRC pushbuttons and indicator lights or can be done via programmable logic controllers (PLCs).

Switching times

OFF -> ON <<500 ms
 from signal to contact closing

ON -> OFF <<250 ms
 from signal to contact opening

TRIP -> OFF -> ON <<1500 ms
 from signal to contact closing

For differing requirements, please contact your local ABB partner

Safety Intelligence

- When detecting manual use, inputs are deactivated for 10 seconds
- If the spindle is rotated more than 360°, all outputs become active
- Manual switch off via lever is possible (S803, S804)
- Manual switch on via lever is not possible (S802)
- RSU is locked for five minutes after three switching attempts leading to a trip
- Mechanical fixation via lock slider blocking the spindle

Properties Accessories

2



2CC041328F0001

S800-RSU-CP

S800-RSU cable incl. 10-pole Micro Fit 3.0 plug

Length of cable: 3 meters
 Cross section: 10 x 0.5 mm²
 Temperature range:
 moving state: -5 °C ... +70 °C
 fixed state: -30 °C ... +80 °C
 Rated voltage: 300V
 Conductor resistance: 39.0 Ω/km
 Approvals: S+, UL

S800-RSU-P

10-pole Micro Fit 3.0 plug

10-pole Micro Fit 3.0 plug with 12 loose crimped contacts. You need tongs for connecting.



2CC041328F0001

S800-SOR

Shunt opening release

The S800-SOR shunt opening release is for remote release of the S800- high performance MCB using an electrical impulse. Operation of the trigger is guaranteed at a voltage between 70 % and 110 % of the rated mains voltage U_n both for AC and DC.

Mounting ability of the S800-SOR operating current release

– The S800-SOR can be mounted by the user at the left side of the high performance MCB.



2CC041328F0001

S800-UVR

Undervoltage release

The S800-UVR undervoltage release can be used as an emergency-stop cut-as by use of suitable emergency stop buttons. The undervoltage release switches the power supply to the high performance MCB off in case of a failure or if the value falls below $0.7 \times U_n$. After tripping, the high performance MCB can be switched back on as soon as the voltage is over $0.85 \times U_n$.

Mounting ability of the S800-UVR undervoltage release

– The S800-UVR can be mounted by the user at the left side of the high performance MCB.



2CC0413018F0002

S803S-SCL

Short-circuit current limiter

The S803S used together with an S803S-SCL ensures reliable switch-off of short-circuit currents up to **100 kA**, at an operating voltage of 440 VAC and over the entire rated current range of up to 125 A.

For applications at 690 VAC, the combination of S803S-SCL ensures reliable short-circuit protection up to **50 kA**; here also, this is ensured over the entire rated current range up to 125 A, typical for the S800.

Example combinations	Rated operational voltage U_e	Ultimate short-circuit breaking capacity I_{cu}	Service short-circuit breaking capacity I_{cs}
S803S-SCL125 +	440VAC	100 kA	100 kA
S803S-C125	690VAC	50 kA	50 kA
S803S-SCL63 +	440VAC	100 kA	100 kA
S803S-K63	690VAC	50 kA	50 kA
S803S-SCL32 +	440VAC	100 kA	100 kA
S803S-B16	690VAC	50 kA	50 kA



20CC412028F0001

S800-SCL-SR
Self-resetting short-circuit limiter

The S800-SCL-SR can be used together with S800S High Performance MCB or Manual Motor Starters. It limits the short-circuit current until the downstream means of protection trips. Its current continuity makes it as the ideal solution for group protection. All parallel branches remain operative.

Minimum cable length between S800-SCL-SR/S803S-SCL and downstream devices (Connection has to be short-circuit proofed acc. to IEC 61439-1)

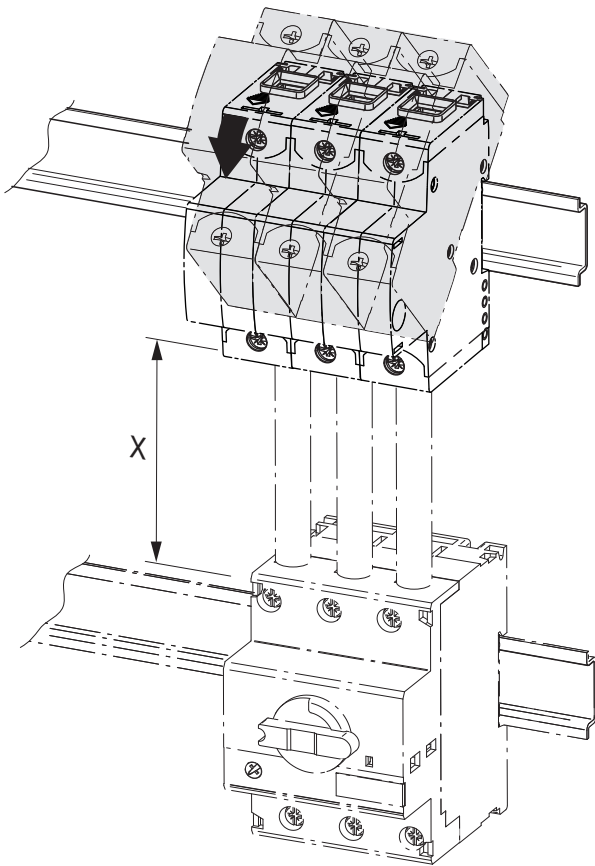

20CC4132180Z0001

MS/M0325
MS/M0132
S800

S800-SCL-SR/S803S-SCL	min. length X	min. cross section
32 A	80 mm	6 mm ²
63 A	80 mm	16 mm ²
100/125 A	250 mm	35 mm ²



20CC0413062F0001

S800-RD Rotary drive

The rotary drive for 2–4 pole devices can be delivered for assembly on the switching field door. Switching is effortless due to the ergonomic design of the swivel lever. It is equipped with a lock for the OFF position that prevents switching on of the S800 high performance MCB. The slot hole of the lock can accept up to 3 padlocks with lug diameters of 7 mm (not included in delivery). Operation of the trigger and a view of the characteristics are not prevented. Additionally, a rotary drive can also be supplied to switch machines; it has a red grip on a yellow background.

The rotary drive on the switching field door is comprised of the following three components:

- Rotary handle S800-RHE-H, -EM
- Axle (500 mm) S800-RHE-S



20CC0413068F0001

S800-IP9 Intermediate piece

The S800-IP9 intermediate piece fits the profile of the high performance MCB and is used to fill in empty device slots. Thanks to its width of just 9mm, the slots of all devices of the S800 range can be expanded using this intermediate piece.



20CC0413068F0001

S800-PLL Padlock device

The S800-PLL padlock device safely prevents unintentional switching on and off. Simply insert the lug of the padlock device through the borehole on the high performance MCB and lock with a padlock with lug diameter \varnothing 4 mm (not included in delivery). Even when the high performance MCB is secured with an padlock device against unintentional switching off, tripping remains possible in case of overload or short-circuit by the S800-SOR, S800-UVR and DDA800.



20CC0413303F0001

S800U-PLL Locking device – for the American market

The S800U-PLL locking device prevents unintentional switch-on or off of the S800U high performance MCB, or switch on/off by third parties. It is mounted at the side of the high performance MCB and can only be removed using a special tool. A standardised American padlock (not included in delivery) is hung onto the round recess on the locking device, which can be secured by max six locks. Of course, tripping is possible by the S800-SOR or S800-UVR in case of overload or short-circuit.



S800-CT, -RT
Interchangeable adapter kit

The S800 interchangeable adapter kit allows the cable clamp – ring terminal connections to be exchanged. Ring terminal connection -> Cage Terminal connection

The following is included in the S800-CT replaceable interchangeable adapter kit:

- Cage terminal
- Insulator

Cage Terminal connection -> ring terminal connection

The following is included in the S800-RT replaceable interchangeable adapter kit:

- Nut, insulation nut – cable lug, Allen screw
- Insulator with 25 mm insulation walls

S800-ILS
Identification labelling system

The individual identification labelling system for ILS legend plates is a DIN A5 polyester foil for inkjet and laser printers with high temperature resistance (if a laser printer is used please check whether self-sticking foils with a thickness of 250 µm can be printed with it). The 3M™9471 LE adhesive backing is UL-approved with Appl. No. MH 11410. The single plates are butt-cut on one side. Can be manually labelled with ink, pen, pencil and felt pen.



S802-LINK50
Pole connector up to 50 A

The pole connector S802-LINK50 can be used up to 50 A.



S802-LINK125
Pole connector up to 125 A

The pole connector S802-LINK125 can be used up to 125 A.

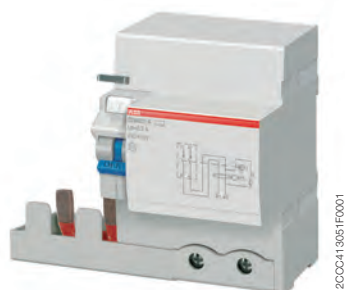

DDA800
RCD Block

RCD blocks from the DDA800 family can be connected to the S800 high performance MCB. The DDA800 can be used both for sine-shaped AC fault currents (type AC) as well as for pulsed DC fault currents (type A). Typical ABB: Selective and short-term delay devices are also available The functionality of the switching device can be checked at any time with the test button. The DDA800 FI switches ensure effective protection against fire and explosion. Devices with $I_n \leq 30 \text{ mA}$ guarantee the protection of persons against shock currents caused by both direct and indirect touching in addition to the obligatory safety measures prescribed by the safety and accident-prevention regulations.

The DDA800 blocks comply to standard:

- EN 60947-2 Annex B



Mounting ability of the DDA800 RCD blocks

- The leakage current trigger can be mounted by the user at the right on the live conductor.

Properties Accessories

2



20CC413048F0001

S800 Busbar system

The S800 busbar system is comprised of:

S804-BBPC120	120 mm ² feed block, 4-pole
S804-BB250	250 A busbar, 3-pole and neutral with 24 contacts pins
S804-BB6	250 A busbar, 3-pole with 6 contacts pins
S803-BB250	250 A busbar, 3-pole with 24 terminal lugs and 2 end caps
S803-BBPC120	120 mm ² feed block, 3-pole
S800-BBIC	Optional contact-protection cap for exposed terminal lugs
S800-END	Optional end cap

The busbar, which can be shortened in length by the user, ensures the safe and rational connection of the S800 high performance MCB. A cable cross-section of up to 120 mm² can be connected at the feed block.



20CC413048F0001

Unifix H

The Unifix H System with feed module up to 400 A provides the user a high standardised design of energy distribution. The wide range of assembly and adapter combinations which are also available for the S800 range increase flexibility allowing for compact and cost-effective design of the electrical distribution network.

The following adapters are available for the S800 range:

- ED2557 L1 ≤32 A
- ED2558 L2 ≤32 A
- ED2559 L3 ≤32 A
- ED2560 N ≤32 A
- ED2551 L1 125 A
- ED2552 L2 125 A
- ED2553 L3 125 A
- ED2554 N 125 A
- ED2550 filler

Rated short-circuit capacity I_{cn}

Compliant to EN 60898-1

The maximum current which a switching device can switch off without damage at a rated operational voltage and rated operational frequency. It is specified as an effective value.

Rated ultimate short-circuit breaking capacity I_{cu}

Compliant to EN 60947-2

Ultimate short-circuit breaking capacity that a circuit breaker can switch off without damage at a rated operational voltage and rated operational frequency. It is specified as an effective value.

Rated service short-circuit breaking capacity I_{cs}

Compliant to EN 60947-2

Service short-circuit breaking capacity that a circuit breaker can switch off without damage at a rated operational voltage and rated operational frequency. It is specified as an effective value.

Rated insulation voltage U_i

The rated insulation voltage is the voltage to which dielectric checks and creepage distances refer. The maximum rated operational voltage must not exceed its rated insulation voltage.

Rated impulse withstand voltage U_{imp}

Peak of a withstand voltage of a specified form and polarity with which the circuit can be loaded under specified test conditions without a breakdown and to which clearances relate. The rated impulse withstand voltage must be equal to or greater than the values of the withstand over-voltages (transient overvoltages) which occur in the System in which the device is used.

Backup protection

Assignment of two overcurrent protective devices in series, where the protective device, generally but not necessarily on the supply side, effects the overcurrent protection with or without the assistance of the other protective device and prevents excessive stress on the latter [IEC 60947-1, definition 2.5.24].

Total selectivity

Overcurrent discrimination where, in the presence of two overcurrent protective devices in series, the protective device on the load side effects the protection without causing the other protective device to operate [IEC 60947-2, definition 2.17.2].

Partial selectivity

Overcurrent discrimination where, in the presence of two overcurrent protective devices in series, the protective device on the load side effects the protection up to a given level of overcurrent, without causing the other protective device to operate [IEC 60947-2, definition 2.17.3].

Table of content S800

Technical data

S800S	3/2
S800N	3/5
S800C	3/7
S800B	3/9
S800HV	3/10
S800U	3/12
S800PV	3/16
Accessories	3/21

230 V Let-through energies

S800S-B, -C, -D, -K	3/37
S800N-B, -C, -D	3/40
S800C-B, -C, -D, -K	3/41
S800B-B, -C, -D, -K	3/42
S800U-K, -Z	3/43

230 V Let-through current

S800S-B, -C, -D, -K	3/44
S800N-B, -C, -D	3/47
S800C-B, -C, -D, -K	3/48
S800B-B, -C, -D, -K	3/49
S800U-K, -Z	3/50

Technical data

S800S

3

	S800S	S803S-KM	S800S-UC
General Data			
Tripping characteristics	B, C, D, K,	KM	UCB, UCK
Standards	IEC/EN 60947-2, EN 60898-1	IEC / EN 60947-2	IEC / EN 60947-2
Poles	1 ... 4	3	1 ... 4
Rated current I_e	A 6 ... 125	20 ... 80	10 ... 125
Rated frequency f	Hz 50/60	50/60	50/60
Rated insulation voltage U_i acc. to IEC/EN 60664-1	V AC 690	AC 690	DC 1000
Rated impulse withstand voltage U_{imp} (1.2/50 μ s)	kV 8	8	8
Overvoltage category	IV	IV	III
Pollution degree	3	3	2
Suitability for isolation	yes	yes	yes
Data acc. to IEC/EN 60898-1			
Rated operational voltage U_e	V AC 230/400	–	–
Min. operating voltage	V AC 12	–	–
Rated short-circuit capacity I_{en}	kA Char. B, C, D: 230/400 V (10 ... 80A) = 25 kA	–	–
Reference temperature for tripping characteristics	°C 30°C (Char. B, C, D)	–	–
Electrical and Mechanical Endurance	ops: 10 ... 32 A: 10 000 electrical/mechanical 40 ... 100 A: 6000 electrical/ 4000 mechanical 125 A: 4000 electrical/6000 mechanical	–	–
Service short-circuit capacity I_{cs}	kA Char. B, C, D: 230/400 V (10 ... 80A) = 12.5 kA	–	–
Data acc. to IEC/EN 60947-2			
Rated operational voltage U_e	V AC 400/690 DC 125 (1-pole) DC 250 (2-pole) DC 375 (3-pole) DC 500 (4-pole)	AC 690	DC 250 (1-pole) DC 500 (2-pole) DC 750 (3-pole) DC 750 (4-pole) (63 ... 125 A) DC 1000 (4-pole) (10 ... 50A)
Min. operating voltage	V AC 12	AC 12	–
Rated ultimate short-circuit capacity I_{cu}	kA AC 240/415 V = 50 kA AC 254/440 V = 30 kA AC 400/690 V (up to 80 A) = 6 kA AC 400/690 V (100 ... 125 A) = 4.5 kA DC 125 V (1-pole) = 30 kA DC 250 V (2-pole) = 30 kA DC 375 V (3-pole) = 30 kA DC 500 V (4-pole) = 30 kA	AC 240/415 V = 50 kA AC 254/440 V = 30 kA AC 400/690 V = 6 kA DC 375 V = 30 kA	DC 250 V (1-pole) = 50 kA DC 500 V (2-pole) = 50 kA DC 750 V (3-pole) = 50 kA DC 750 V (4-pole) = 50 kA
Rated service short-circuit capacity I_{cs}	kA AC 240/415 V = 40 kA AC 254/440 V (up to 80 A) = 22.5 kA AC 254/440 V (100 ... 125 A) = 15 kA AC 400/690 V (up to 80 A) = 4 kA AC 400/690 V (100 ... 125 A) = 3 kA DC 125 V (1-pole) = 30 kA DC 250 V (2-pole) = 30 kA DC 375 V (3-pole) = 30 kA DC 500 V (4-pole) = 30 kA	DC 375 V = 30 kA	DC 250 V (1-pole) = 50 kA DC 500 V (2-pole) = 50 kA DC 750 V (3-pole) = 50 kA DC 750 V (4-pole) = 50 kA
Reference temperature for tripping characteristics	°C B, C, D: 30 °C K: 40 °C	only magnetic release	UCB: 30 °C UCK: 40 °C
Electrical and Mechanical Endurance	ops: 6 ... 32 A: 10 000 electrical/ mechanical 40 ... 100 A: 6000 electrical/ 4000 mechanical 125 A: 4000 electrical/ 6000 mechanical	20 ... 32 A: 10 000 electrical/ mechanical 20 ... 32 A: 10 000 electrical/ mechanical 40 ... 80 A: 6000 electrical/ 4000 mechanical	10 ... 100 A: 1500 electrical/ 8500 mechanical 125 A: 1000 electrical 7000 mechanical

		S800S	S803S-KM	S800S-UC
Mechanical Data				
Housing		Material group I, RAL 7035		
Toggle		black, lockable		
Classification acc. to NF F 126-101, NF F 16-102		I3, F2		
Protection degree acc. to EN 60529		IP20; IP40(actuating end only)		
Shock resistance acc. to IEC/EN 60068-2-31		IEC 61373 Cat. 1 Class B, 5g / 30 ms acc. to IEC 60068-27 Test Ea		
Vibration resistance acc. to IEC/EN 60068-2-6		IEC 60068-2-6 Test Fc; 2 - 13.2Hz / 1 mm 13.2 - 100Hz / 0.7g with load 100% x I _e		
Environmental conditions (damp heat) acc. to IEC/EN 60068-2-30	°C/RH	12 + 12 cycle with 55 °C/90–96 % and 25 °C/95–100 %		
Environmental conditions (dry heat) acc. to IEC/EN 60068-2-2 Test B	°C/RH	16 hours 55 °C / 2 hours 70 °C with damp heat 55 %		
Ambient temperature	°C	–25 ... +60		
Storage temperature	°C	–40 ... +70		
Installation				
Terminal		Failsafe cage or ringlug terminal		
Connections (top/bottom) – C _u only	mm ²	1 ... 50 stranded 1 ... 70 flexible		
Tightening torque	Nm in-lbs.	3.5 31		
Screwdriver		POZI 2		
Mounting		EN 60715		
Mounting position		any		
Supply		any		
Dimensions and weight				
Pole dimensions (H x L x W)	mm	82.5 x 95 x 26.5		
Pole weight	g	ca. 240		

Typical internal resistances and power losses at 25 °C ambient temperature (per pole)

Rated current I _n [A]	Internal resistance R _i [mΩ]			Power loss P _v [W]		
	B, C, D, K	KM	UCB, UCK	B, C, D, K	KM	UCB, UCK
6	51.7	–	–	1.8	–	–
8	27.2	–	–	1.7	–	–
10	15.2	–	15.2	1.5	–	1.5
13	12.1	–	12.1	2	–	2
16	12.1	–	12.1	3.1	–	3.1
20	8.7	2.7	8.7	3.5	1.1	3.5
25	6.8	3	6.8	4.3	1.9	4.3
32	3.1	1.7	3.1	3.2	1.7	3.2
40	2.3	1.6	2.3	3.7	2.6	3.7
50	1.7	1.1	1.7	4.3	2.8	4.3
63	1.6	1	1.6	6.4	4	6.4
80	1	0.75	1	6.4	5	6.4
100	0.8	–	0.8	8	–	8
125	0.6	–	0.6	9.4	–	9.4

Technical data

S800S

Maximum permissible earth-fault loop impedance Z_s at U_0 230 V* to ensure compliance with the requirements of IEC 60364-4

The instantaneous release of the MCB ensures an operating time of max. 0.1 s (TN system). Determined according to IEC 60364-5-52 / VDE 0100-520 and DIN VDE 0100-520 sheet 2:2002 (source impedance 300 m Ω , $c = 0.95$ and conductor temperature 70 °C = factor 0.8). The internal resistance of the MCB is included.

* U_0 : rated voltage against earthed conductor; for U_n : AC 240 V multiply Z_s by 1.04, for U_n : AC 254 V multiply Z_s by 1.10, for U_n : AC 400 V multiply Z_s by 1.74

Rated current (A)	B	C max. Z_s (Ω)	D	K
6		on request		
8		on request		
10	4.8	2.4	1.5	1.5
13	3.7	1.8	1.1	1.1
16	3.0	1.5	0.9	0.9
20	2.4	1.2	0.7	0.7
25	1.9	1.0	0.6	0.6
32	1.5	0.7	0.5	0.5
40	1.2	0.6	0.4	0.4
50	1.0	0.5	0.3	0.3
63	0.8	0.4	0.2	0.2
80	0.6	0.3	0.2	0.2
100	0.5	0.2	0.1	0.1
125	0.4	0.2	0.1	0.1

Technical data

S800N

S800N

General Data		
Tripping characteristics		B, C, D
Standards		IEC/EN 60947-2, EN 60898-1
Poles		1 ... 4
Rated current I_e	A	6 ... 125
Rated frequency f	Hz	50/60
Rated insulation voltage U_i acc. to IEC/EN 60664-1	V	AC 690
Rated impulse withstand voltage U_{imp} (1.2/50 μ s)	kV	8
Overvoltage category		IV
Pollution degree		3
Suitability for isolation		yes
Data acc. to IEC/EN 60898-1		
Rated operational voltage U_e	V	AC 230/400
Min. operating voltage	V	AC 12
Rated short-circuit capacity I_{sc}	kA	AC 230/400 V (10 ... 80 A) = 20 kA
Reference temperature for tripping characteristics	$^{\circ}$ C	30 $^{\circ}$ C (Char. B, C, D)
Electrical and Mechanical Endurance	ops.	10 ... 32 A: 10 000 electrical/10 000 mechanical 40 ... 100 A: 6000 electrical/10 000 mechanical 125 A: 4000 electrical/10 000 mechanical
Service short-circuit capacity I_{cs}	kA	230/400 V (10 ... 80 A) = 10 kA
Data acc. to IEC/EN 60947-2		
Rated operational voltage U_e	V	AC 400/690 DC 125 (1-pole) DC 250 (2-pole) DC 375 (3-pole) DC 500 (4-pole)
Min. operating voltage	V	AC 12
Rated ultimate short-circuit capacity I_{cu}	kA	AC 240/415 V = 36 kA AC 254/440 V = 20 kA AC 400/690 V = 4.5 kA DC 125 V (1-pole) = 20 kA DC 250 V (2-pole) = 20 kA DC 375 V (3-pole) = 20 kA DC 500 V (4-pole) = 20 kA
Rated service short-circuit capacity I_{cs}	kA	AC 240/415 V = 30 kA AC 289/500 V (80 ... 125 A) = 5 kA AC 400/690 V = 3 kA DC 125 V (1-pole) = 20 kA DC 250 V (2-pole) = 20 kA DC 375 V (3-pole) = 20 kA DC 500 V (4-pole) = 20 kA
Reference temperature for tripping characteristics	$^{\circ}$ C	30 $^{\circ}$ C
Electrical and Mechanical Endurance	ops.	6 ... 32 A: 10 000 electrical/10 000 mechanical 40 ... 100 A: 6000 electrical/10 000 mechanical 125 A: 4000 electrical/10 000 mechanical
Mechanical Data		
Housing		Material group I, RAL 7035
Toggle		black, lockable
Classification acc. To NF F 126-101, NF F 16-102		I3, F2
Protection degree acc. to EN 60529		IP20; IP40 (actuating end only)
Shock resistance acc. to IEC/EN 60068-2-30		IEC 61373 Cat. 1 Class B, 5g / 30ms acc. To IEC 60068-27 Test Ea
Vibration resistance acc. to IEC/EN 60068-2-6		IEC 60068-2-6 Test Fc; 2-13.2 Hz/1 mm 13.2-100 Hz/0.7 g with load 100% $\times I_e$
Environmental conditions (damp heat) acc. to IEC/EN 60068-2-30 and 25 $^{\circ}$ C/95-100 %		$^{\circ}$ C/RH 12 + 12 cycle with 55 $^{\circ}$ C/90-96 %
Environmental conditions (dry heat) acc. to IEC/EN 60068-2-2 Test B damp heat 55 %		$^{\circ}$ C/RH 16 hours 55 $^{\circ}$ C/2 hours 70 $^{\circ}$ C with
Ambient temperature	$^{\circ}$ C	-25 ... +60
Storage temperature	$^{\circ}$ C	-40 ... +70

Technical data

S800N

3

		S800N
Installation		
Terminal		Failsafe cage or ringlug terminal
Connections (top/bottom) – C _u only	mm ²	1 ... 50 stranded 1 ... 70 flexible
Tightening torque	Nm in-lbs.	3.5 31
Screwdriver		POZI 2
Mounting		EN 60715
Mounting position		any
Supply		any
Dimensions and weight		
Pole dimensions (H x L x W)	mm	82.5 x 95 x 26.5
Pole weight	g	ca. 240

Typical internal resistances and power losses at 25 °C ambient temperature (per pole)

Rated current I _n [A]	Internal resistance R _i [mΩ] B, C, D	Power loss P _v [W] B, C, D
6	51.7	1.8
8	27.2	1.7
10	15.2	1.5
13	12.1	2
16	12.1	3.1
20	8.7	3.5
25	6.8	4.3
32	3.1	3.2
40	2.3	3.7
50	1.7	4.3
63	1.6	6.4
80	1.0	6.4
100	0.8	8
125	0.6	9.4

Maximum permissible earth-fault loop impedance Z_s at U₀ 230 V* to ensure compliance with the requirements of IEC 60364-4

The instantaneous release of the MCB ensures an operating time of max. 0.1 s (TN system). Determined according to IEC 60364-5-52 / VDE 0100-520 and DIN VDE 0100-520 sheet 2:2002 (source impedance 300 mΩ, c = 0.95 and conductor temperature 70 °C = factor 0.8). The internal resistance of the MCB is included.

* U₀: rated voltage against earthed conductor; for U₀: AC 240 V multiply Z_s by 1.04, for U₀: AC 254 V multiply Z_s by 1.10, for U₀: AC 400 V multiply Z_s by 1.74

Rated current (A)	B	C max. Z _s (Ω)	D
6		on request	
8		on request	
10	4.8	2.4	1.5
13	3.7	1.8	1.1
16	3.0	1.5	0.9
20	2.4	1.2	0.7
25	1.9	1.0	0.6
32	1.5	0.7	0.5
40	1.2	0.6	0.4
50	1.0	0.5	0.3
63	0.8	0.4	0.2
80	0.6	0.3	0.2
100	0.5	0.2	0.1
125	0.4	0.2	0.1

Technical data

S800C

S800C

General Data		
Tripping characteristics		B, C, D, K
Standards		IEC/EN 60947-2, EN 60898-1
Poles		1 ... 4
Rated current I_e	A	10 ... 125
Rated frequency f	Hz	50/60
Rated insulation voltage U_i acc. to IEC/EN 60664-1	V	AC 500
Rated impulse withstand voltage U_{imp} . (1.2/50 μ s)	kV	8
Overvoltage category		IV
Pollution degree		3
Suitability for isolation		yes
Data acc. to IEC/EN 60898-1		
Rated operational voltage U_e	V	AC 230/400
Min. operating voltage	V	AC 12
Rated short-circuit capacity I_{en}	kA	15 kA
Reference temperature for tripping characteristics	$^{\circ}$ C	30 $^{\circ}$ C (Char. B, C, D)
Electrical and Mechanical Endurance	ops.	10 ... 32 A: 10 000 electrical/10 000 mechanical 40 ... 100 A: 6000 electrical/10 000 mechanical 125 A: 4000 electrical/10 000 mechanical
Service short-circuit capacity I_{cs}	kA	Char. B, C, D: 230/400 V = 7.5 kA
Data acc. to IEC/EN 60947-2		
Rated operational voltage U_e	V	AC 254/440 DC 125 (1-pole) DC 250 (2-pole) DC 375 (3-pole) DC 500 (4-pole)
Min. operating voltage	V	AC 12
Rated ultimate short-circuit capacity I_{cu}	kA	AC 240/415 V = 25 kA AC 254/440 V = 15 kA DC 125 V (1-pole) = 10 kA DC 250 V (2-pole) = 10 kA DC 375 V (3-pole) = 10 kA DC 500 V (4-pole) = 10 kA
Rated service short-circuit capacity I_{cs}	kA	AC 240/415 V = 18 kA AC 254/440 V = 10 kA DC 125 V (1-pole) = 10 kA DC 250 V (2-pole) = 10 kA DC 375 V (3-pole) = 10 kA DC 500 V (4-pole) = 10 kA
Reference temperature for tripping characteristics	$^{\circ}$ C	B, C, D: 30 $^{\circ}$ C K: 40 $^{\circ}$ C
Electrical and Mechanical Endurance	ops.	10 ... 32 A: 10 000 electrical/10 000 mechanical 40 ... 100 A: 6000 electrical/ 10 000 mechanical 125 A: 4000 electrical/ 10 000 mechanical
Mechanical Data		
Housing		Material group I, RAL 7035
Toggle		black, lockable
Classification acc. To NF F 126-101, NF F 16-102		I3, F2
Protection degree acc. to EN 60529		IP20; IP40 (actuating end only)
Shock resistance acc. to IEC/EN 60068-2-30		IEC 61373 Cat. 1 Class B, 5 g / 30 ms acc. To IEC 60068-2-7 Test Ea
Vibration resistance acc. to IEC/EN 60068-2-6		IEC 60068-2-6 Test Fc; 2–13.2 Hz/1 mm 13.2–100 Hz/0.7 g with load 100 % x I_e
Environmental conditions (damp heat) acc. to IEC/EN 60068-2-30 and 25 %/95–100 %		$^{\circ}$ C/RH 12 + 12 cycle with 55 $^{\circ}$ C/90–96 %
Environmental conditions (dry heat) acc. to IEC/EN 60068-2-2 Test B damp heat 55 %		$^{\circ}$ C/RH 16 hours 55 $^{\circ}$ C/2 hours 70 $^{\circ}$ C with

Technical data

S800C

Ambient temperature	°C	-25 ... +60
Storage temperature	°C	-40 ... +70

S800C

Installation

Terminal		Failsafe cage or ringlug terminal
Connections (top/bottom) – Cu only	mm ²	1 ... 50 stranded 1 ... 70 flexible
Tightening torque	Nm in-lbs.	3.5 31
Screwdriver		POZI 2
Mounting		EN 60715
Mounting position		any
Supply		any

Dimensions and weight

Typical internal resistances and power losses at 25 °C ambient temperature (per pole)

Rated current I _n [A]	Internal resistance R _i [mΩ] B, C, D, K	Power loss P _v [W] B, C, D, K
10	15.2	1.5
13	12.1	2
16	12.1	3.1
20	8.7	3.5
25	6.8	4.3
32	3.1	3.2
40	2.3	3.7
50	1.7	4.3
63	1.6	6.4
80	1	6.4
100	0.8	8
125	0.6	9.4

Maximum permissible earth-fault loop impedance Z_s at U₀ 230 V* to ensure compliance with the requirements of IEC 60364-4

The instantaneous release of the MCB ensures an operating time of max. 0.1 s (TN system). Determined according to IEC 60364-5-52 / VDE 0100-520 and DIN VDE 0100-520 sheet 2:2002 (source impedance 300 mΩ, c = 0.95 and conductor temperature 70 °C = factor 0.8). The internal resistance of the MCB is included.

* U₀: rated voltage against earthed conductor; for U₀: AC 240V multiply Z_s by 1.04, for U₀: AC 254V multiply Z_s by 1.10, for U₀: AC 400V multiply Z_s by 1.74

Rated current (A)	B	C max. Z _s (Ω)	D	K
10	4.8	2.4	1.5	1.5
13	3.7	1.8	1.1	1.1
16	3.0	1.5	0.9	0.9
20	2.4	1.2	0.7	0.7
25	1.9	1.0	0.6	0.6
32	1.5	0.7	0.5	0.5
40	1.2	0.6	0.4	0.4
50	1.0	0.5	0.3	0.3
63	0.8	0.4	0.2	0.2
80	0.6	0.3	0.2	0.2
100	0.5	0.2	0.1	0.1
125	0.4	0.2	0.1	0.1

Technical data

S800B

		S800B
General Data		
Tripping characteristics		B, C, D, K
Standards		IEC/EN 60947-2, EN 60898-1
Poles		1 ... 4
Rated current I_n	A	Char. B, C: 32 ... 125/Char. D, K: 32 ... 125
Rated frequency f	Hz	50/60
Rated insulation voltage U_i acc. to IEC/EN 60664-1	V	AC 500
Rated impulse withstand voltage U_{imp} . (1.2/50 μ s)	kV	6
Overvoltage category		III
Pollution degree		3
Suitability for isolation		yes
Data acc. to EN 60898-1		
Rated operational voltage U_e	V	AC 230/400
Min. operating voltage	V	AC 12
Rated short-circuit capacity I_{cn}	kA	AC 230/400 = 10 kA
Reference temperature for tripping characteristics	$^{\circ}$ C	B, C, D: 30 $^{\circ}$ C
Electrical and Mechanical Endurance	ops.	4000
Service short-circuit capacity I_{cs}	kA	AC 230/400 = 7.5 kA
Data acc. to IEC/EN 60947-2		
Rated operational voltage U_e	V	AC 230/400
Min. operating voltage	V	AC 12
Rated ultimate short-circuit capacity I_{cu}	kA	16 kA
Rated service short-circuit capacity I_{cs}	kA	10 kA
Reference temperature for tripping characteristics	$^{\circ}$ C	B, C, D: 30 $^{\circ}$ C K: 40 $^{\circ}$ C
Electrical and Mechanical Endurance	ops.	32 ... 100 A: 1500 electric; 10 000 mechanic/125 A: 1000 electric, 8000 mechanic
Mechanical Data		
Housing		Material group I, RAL 7035
Toggle		black, lockable
Classification acc. To NF F 126-101, NF F 16-102		I3, F2
Protection degree acc. to EN 60529		IP20; IP40(actuating end only)
Shock resistance acc. to IEC/EN 60068-2-30		
Vibration resistance acc. to IEC/EN 60068-2-6		
Environmental conditions (damp heat) acc. to IEC/EN 60068-2-30		$^{\circ}$ C/RH
Environmental conditions (dry heat) acc. to IEC/EN 60068-2-2 Test B		$^{\circ}$ C/RH
Ambient temperature	$^{\circ}$ C	-25 ... +60
Storage temperature	$^{\circ}$ C	-40 ... +70
Installation		
Terminal		Failsafe cage terminal
Connections (top/bottom) – C_u only	mm ²	1 ... 50 stranded; 1 ... 70 flexible
Tightening torque	Nm	3.5
	in-lbs.	31
Screwdriver		POZI 2
Mounting		EN 60715
Mounting position		any
Supply		any
Dimensions and weight		
Pole dimensions (H x L x W)	mm	82.5 x 95 x 26.5
Pole weight	g	ca. 240

Typical internal resistances and power losses at 25 $^{\circ}$ C ambient temperature (per pole)

Rated current I_n [A]	Internal resistance R_i [m Ω]		Power loss P_v [W]	
	B, C	D, K	B, C	D, K
32	3.1	3.1	3.2	3.2
40	2.3	2.3	3.7	3.7
50	1.7	1.7	4.3	4.3
63	1.6	1.6	6.4	6.4
80	1.0	1.0	6.4	6.4
100	0.8	0.8	8.0	8.0
125	0.7	–	10.9	–

Technical data

S800HV

3

General data

Tripping characteristic		K
Standard		IEC 60947-2
Poles		1 ... 3
Rated frequency f	Hz	50/60
Overvoltage category		III
Pollution degree		2
Suitability for isolation		yes

Data acc. to IEC 60947-2

Rated operational voltage U_e	V	AC 580/1000
Rated operational current I_n	A	6 ... 125
Rated ultimate short-circuit breaking capacity I_{cu}	kA	4 (6 ... 63 A)
		3 (80 ... 125 A)
Rated service short-circuit breaking capacity I_{cs}	kA	2.5 (6 ... 63 A)
		2 (80 ... 125 A)
Rated insulation voltage U_i	V	AC 1000
Rated impulse withstand voltage U_{imp}	kV	8
Reference temperature for tripping characteristic	°C	40
Electrical and Mechanical endurance	ops.	1500 electric / 10 000 mechanical

Mechanical data

Housing		Material group I, RAL 7035
Toggle		black, lockable
Protection degree acc. to IEC / EN 60529		IP20; IP40 (actuating side only)
Classification acc. to NF F16-101, NF F 16-102		I3, F2
Classification acc. to IEC 61373 (shock and vibration)		Cat. 1, Class B
Shock resistance acc. to IEC / EN 60068-2-27		Test Ea: 5 g / 30 ms
Vibration resistance acc. to IEC / EN 60068-2-6		Test Fc:
		2–13.2 Hz / 1 mm
		13.2–100 Hz / 0.7 g
		with load 100% x I_e
Environmental conditions (damp heat) acc. to IEC / EN 60068-2-30		12+12 cycle with 55 °C / 90–96 % RH and 25 °C / 95–100 % RH
Environmental conditions (dry heat) acc. to IEC / EN 60068-2-2		16 hours 55 °C / 2 hours 70 °C / 55% RH
Ambient temperature	°C	–25 ... +60
Storage temperature	°C	–40 ... +70

Installation

Terminal		Failsafe cage terminal
Connection (top/bottom) – Cu only	mm ²	1 ... 50 stranded
		1 ... 70 flexible
Tightening torque	Nm	3.5
Screwdriver		POZI 2
Mounting		EN 60715
Mounting position		any
Supply side		any

Dimension and weight

Pole dimension (H x L x W)	mm	142 x 82.5 x 26.5
Pole weight	kg	0.27

Altitude

Altitude	[m]	2000	3000	4000	5000
Rated impulse withstand voltage U_{imp}	[kV]	8	8	8	8
Rated operational voltage U_e	[V]	1000	870	780	690
Max. rated current I_n	[A]	1 x I_n	0.96 x I_n	0.93 x I_n	0.9 x I_n

Technical data

S800HV

Typical internal resistances and power losses at 25 °C ambient temperature (per pole)

Rated current I _n [A]	Internal resistance R _i [mΩ] K, Z	Power loss P _v [W] K, Z
6	51.7	1.8
8	27.2	1.7
10	15.2	1.5
13	12.1	2
16	12.1	3.1
20	8.7	3.5
25	6.8	4.3
32	3.1	3.2
40	2.3	3.7
50	1.7	4.3
63	1.6	6.4
80	1	6.4
100	0.8	8
125	0.6	9.4

Technical data

S800U

3

		S800U
General Data		
Tripping characteristics		K, Z
Standards		UL489
Poles		1 ... 4
Rated current I_e	A	10–100
Rated frequency f	Hz	50/60
Rated insulation voltage U_i acc. to IEC/EN 60664-1	V	AC 690
Rated impulse withstand voltage $U_{imp.}$ (1.2/50 μ s)	kV	8
Overvoltage category		IV
Pollution degree		3
Suitability for isolation		yes
Data acc. to IEC/EN 60947-2		
Rated operational voltage U_e	V	AC 240/415
Min. operating voltage	V	AC 12
Rated ultimate short-circuit capacity I_{cu}	kA	AC 240 V (1-pole) = 30 kA AC 415 V (multipole) = 50 kA
Rated service short-circuit capacity I_{cs}	kA	AC 240 V (1-pole) = 25 kA AC 415 V (multipole) = 40 kA
Reference temperature for tripping characteristics		25 °C
Electrical and Mechanical Endurance	ops.	10 ... 32 A: 10 000 electrical/10 000 mechanical 40 ... 100 A: 6000 electrical/10 000 mechanical 125 A: 4000 electrical/10 000 mechanical
Data acc. to UL / CSA		
Rated voltage	V	AC 240
Rated interrupting capacity acc. to UL 1077	kA	
Short-circuit current rating acc. to UL 489	kA	AC 240 V (1-pole) = 30 kA AC 240 V (multipole) = 50 kA
Short-circuit current rating acc. to UL 489B	kA	
Reference temperature for tripping characteristics		25 °C
Electrical and Mechanical endurance	ops.	acc. to UL489 6000 electrical; 10 000 mechanical
Mechanical Data		
Protection degree acc. to EN 60529		IP20; IP40 (actuating end only)
Shock resistance acc. to IEC/EN 60068-2-30		IEC 61373 Cat. 1 Class B, 5 g/30 ms acc. To IEC 60068-27 Test Ea
Vibration resistance acc. to IEC/EN 60068-2-6		IEC 60068-2-6 Test Fc; 2–13.2 Hz/1 mm 13.2–100 Hz/0.7 g with load 100 % $\times I_e$
Environmental conditions (damp heat) acc. to IEC/EN 60068-2-30 and 25 °C/95–100 %		°C/RH 12 + 12 cycle with 55 °C/90–96 %
Environmental conditions (dry heat) acc. to IEC/EN 60068-2-2 Test B damp heat 55 %		°C/RH 16 hours 55 °C/2 hours 70 °C with
Ambient temperature	°C	–25 ... +60
Storage temperature	°C	–40 ... +70
Installation		
Terminal		Failsafe cage or ringlug terminal
Connections (top/bottom) – C_u only	mm ²	1 ... 50 stranded 1 ... 70 flexible
	AWG	10–30 A: 14-2 AWG 40–100 A: 1-8 AWG
Tightening torque	Nm	3,5
	in-lbs.	31
Screwdriver		POZI 2
Mounting		any
Mounting position		any
Supply		any
Dimensions and weight		

Technical data

S800U

Typical internal resistances and power losses at 25 °C ambient temperature (per pole)

Rated current I_n [A]	Internal resistance R_i [mΩ] K, Z	Power loss P_v [W] K, Z
10	15.2	1.5
15	12.1	2.7
20	8.7	3.5
25	6.8	4.2
30	3.1	2.8
40	2.3	3.7
50	1.7	4.3
60	1.6	5.8
70	1.0	4.9
80	1.0	6.4
90	0.8	6.5
100	0.8	8.3

Technical data

S804U-UCZ

3

		S804U-UCZ
General Data		
Tripping characteristics		UCZ
Standards		UL489
Poles		4
Rated current I_e	A	10–80
Rated frequency f	Hz	–
Rated insulation voltage U_i acc. to IEC/EN 60664-1	V	DC 1500
Rated impulse withstand voltage U_{imp.} (1.2/50 μs)	kV	8
Overvoltage category		IV
Pollution degree		3
Suitability for isolation		yes
Data acc. to IEC/EN 60947-2		
Rated operational voltage U_e	V	–
Min. operating voltage	V	–
Rated ultimate short-circuit capacity I_{cu}	kA	–
		–
Rated service short-circuit capacity I_{cs}	kA	–
		–
Reference temperature for tripping characteristics	°C	–
Electrical and Mechanical Endurance	ops.	–
Data acc. to UL / CSA		
Rated voltage	V	DC 600
Rated interrupting capacity acc. to UL 1077	kA	–
Short-circuit current rating acc. to UL 489	kA	10
Short-circuit current rating acc. to UL 489B	kA	–
Reference temperature for tripping characteristics		25°C
Electrical and Mechanical endurance	ops.	acc. to UL489 6000 electrical; 10 000 mechanical
Mechanical Data		
Protection degree acc. to EN 60529		IP20; IP40 (actuating end only)
Shock resistance acc. to IEC/EN 60068-2-30		–
Vibration resistance acc. to IEC/EN 60068-2-6		–
Environmental conditions (damp heat) acc. to IEC/EN 60068-2-30		°C/RH
Environmental conditions (dry heat) acc. to IEC/EN 60068-2-2 Test B		°C/RH
Ambient temperature	°C	–25 ... +60
Storage temperature	°C	–40 ... +70
Installation		
Terminal		Failsafe cage terminal
Connections Cu (top/bottom)	AWG	10–32 A: 14-2 AWG 40–80 A: 1/0-8 AWG
Tightening torque	Nm	3.5
	in-lbs.	31
Screwdriver		POZI 2
Mounting		any
Mounting position		any
Supply		any
Dimensions and weight		
Pole dimensions (H x L x W)	mm	142 x 26.5 x 82.5
Pole weight	g	240

Technical data

S804U-PVS

S804U-PVS

		S804U-PVS
General Data		
Tripping characteristics		PVS
Standards		UL489B (Photovoltaik)
Poles		4
Rated current I_e	A	5
Rated frequency f	Hz	–
Rated insulation voltage U_i acc. to IEC/EN 60664-1	V	DC 1500
Rated impulse withstand voltage $U_{imp.}$ (1.2/50 μ s)	kV	8
Overvoltage category		IV
Pollution degree		3
Suitability for isolation		yes
Data acc. to IEC/EN 60947-2		
Rated operational voltage U_e	V	–
Min. operating voltage	V	–
Rated ultimate short-circuit capacity I_{cu}	kA	–
		–
Rated service short-circuit capacity I_{cs}	kA	–
		–
Reference temperature for tripping characteristics	°C	–
Electrical and Mechanical Endurance	ops.	–
Data acc. to UL / CSA		
Rated voltage	V	DC 1000
Rated interrupting capacity acc. to UL 1077	kA	–
Short-circuit current rating acc. to UL 489	kA	–
Short-circuit current rating acc. to UL 489B	kA	3 kA
Reference temperature for tripping characteristics		50 °C
Electrical and Mechanical endurance	ops.	acc. to UL489B
		1000 electrical/ 1000 mechanical
Mechanical Data		
Protection degree acc. to EN 60529		IP20; IP40 (actuating end only)
Shock resistance acc. to IEC/EN 60068-2-30		–
Vibration resistance acc. to IEC/EN 60068-2-6		–
Environmental conditions (damp heat) acc. to IEC/EN 60068-2-30		°C/RH –
Environmental conditions (dry heat) acc. to IEC/EN 60068-2-2 Test B		°C/RH –
Ambient temperature	°C	–25 ... +60
Storage temperature	°C	–40 ... +70
Installation		
Terminal		Failsafe cage terminal
Connections (top/bottom) – C_u only	mm ²	1 ... 50 stranded
		1 ... 70 flexible
	AWG	14 AWG – 2 AWG
		Single conductor per terminal, 75C wire
Flexible Cross-section of conductors (top/bottom)	mm ²	14 AWG – 2 AWG
	AWG	14 AWG – 2 AWG
		Single conductor per terminal – copper only, 75C wire
Tightening torque	Nm	3.5
	in-lbs.	31
Screwdriver		POZI 2
Mounting		any
Mounting position		any
Supply		any
Dimensions and weight		
Pole dimensions (H x L x W)	mm	142 x 26.5 x 82.5
Pole weight	g	240

Technical data

S800PV-SP

3

		S800PV-SP
General Data		
Tripping characteristics		B
Standards		IEC / EN 60947-2 and Annex P
Poles		2 ... 4
Rated current I_e	A	5 ... 125
Rated frequency f	Hz	–
Rated insulation voltage U_i acc. to IEC/EN 60664-1	V	DC 1500
Rated impulse withstand voltage U_{imp} (1.2/50 μ s)	kV	8
Overvoltage category		III
Pollution degree		2
Suitability for isolation		yes
Data acc. to IEC/EN 60947-2		
Rated operational voltage U_e	V	2-pole DC 800 V: 5 ... 80 A 3-pole DC 1200 V: 5 ... 80 A 4-pole DC 1500 V: 5 ... 125 A
Min. operating voltage	V	–
Rated ultimate short-circuit capacity I_{cu}	kA	5 ... 16 A acc. IEC 60947-2 Annex P. $I_{cu} = 5$ kA 20 ... 125 A, acc. IEC 60947-2, $I_{cu} = 5$ kA 20 ... 125 A, acc. IEC 60947-2 Annex P. $I_{cu} = 3$ kA
Rated service short-circuit capacity I_{cs}	kA	$I_{cu} = I_{cs}$
Reference temperature for tripping characteristics		40 °C
Electrical and Mechanical Endurance	ops.	acc. to Annex P: 5 ... 16 A: 300 electrical/ 9700 mechanical acc. to IEC 60947-2 (general part): 20 ... 100 A: 1500 electrical/ 8500 mechanical 125 A: 1000 electrical/ 9000 mechanical
Mechanical Data		
Housing		–
Toggle		Material group I, RAL 7035 black, lockable
Classification acc. To NF F 126-101, NF F 16-102		–
Protection degree acc. to EN 60529		IP20; IP40 (actuating end only)
Shock resistance acc. to IEC/EN 60068-2-30		IEC 61373 Cat. 1 Class B, 5 g / 30 ms acc. To IEC 60068-27 Test Ea
Vibration resistance acc. to IEC/EN 60068-2-6		IEC 60068-2-6 Test Fc; 2–13.2 Hz/1 mm 13.2–100 Hz/0.7 g with load 100 % x I_e
Environmental conditions (damp heat) acc. to IEC/EN 60068-2-30	°C/RH	12 + 12 cycle with 55 °C/90–96 % and 25 °C/95–100 %
Environmental conditions (dry heat) acc. to IEC/EN 60068-2-2 Test B	°C/RH	16 hours 55 °C/2 hours 70 °C with damp heat 55 %
Ambient temperature	°C	–25 ... +60
Storage temperature	°C	–25 ... +70
Installation		
Terminal		Failsafe cage or ringlug terminal
Connections (top/bottom) – C_u only	mm ²	1 ... 50 stranded 1 ... 70 flexible
Tightening torque	Nm in-lbs.	3,5 31
Screwdriver		POZI 2
Mounting		any
Mounting position		any
Supply		any
Dimensions and weight		
Pole dimensions (H x L x W)	mm	95 x 26,5 x 82,5
Pole weight	g	240

Technical data

S802PV-M-H and S804PV-SD

		S802PV-M-H	S800PV-SD
General Data			
Tripping characteristics		–	–
Standards		IEC / EN 60947-3	IEC / EN 60947-3 and Annex D
Poles		2 (polarized)	2...4
Tripping characteristics		none	none
Rated current I_e	A	32, 63, 125	32, 63, 125
Rated insulation voltage U_i acc. to IEC/EN 60664-1	V	DC 1500	DC 1500
Rated impulse withstand voltage $U_{imp.}$ (1.2/50 μ s)	kV		8
Overvoltage category			III
Pollution degree			2
Suitability for isolation			yes
Data acc. to IEC/EN 60947-3			
Rated operational voltage U_e	V	DC 1000V: 2-pole	DC 800V: 2-pole DC 1200V: 3-Pole DC 1500V: 4-pole
Min. operating voltage	V	–	–
Rated short-term withstand current I_{cw}	kA		1.5
Rated short-circuit making capacity I_{cm}	kA		0.5
Utilisation category			DC-21 A, DC-PV2
Electrical and Mechanical Endurance	ops.		32, 63A: 1500 electric; 8500 mechanic 125 A: 1000 electrical, 7000 mechanic acc. to IEC 60947-3
Mechanical Data			
Housing			Material group I, RAL 7035
Toggle			black, lockable
Classification acc. To NF F 126-101, NF F 16-102			
Protection degree acc. to EN 60529			IP20, IP40 (actuating end only)
Shock resistance acc. to IEC/EN 60068-2-30			IEC 61373 Cat. 1 Class B, 5 g/30 ms acc. to IEC 60068-27 Test Ea
Vibration resistance acc. to IEC/EN 60068-2-6			IEC 60068-2-6 Test Fc; 2–13.2 Hz/1 mm 13.2–100 Hz/0.7 g with load 100 % $\times I_e$
Environmental conditions (damp heat) acc. to IEC/EN 60068-2-30	°C/RH		12 + 12 cycle with 55 °C/90–96 % and 25 °C/95–100 %
Environmental conditions (dry heat) acc. to IEC/EN 60068-2-2 Test B	°C/RH		16 hours 55 °C/2 hours 70 °C with damp heat 55 %
Ambient temperature	°C		–25 ... +60
Storage temperature	°C		–25 ... +70
Installation			
Terminal			Failsafe cage or ringlug terminal
Connections (top/bottom) – C_u only	mm ²		1 ... 50 stranded 1 ... 70 flexible
Tightening torque	Nm in-lbs.		3.5 31
Screwdriver			POZI 2
Mounting			any
Mounting position			any
Supply			any (taking into account the polarization)
Dimensions and weight			
Pole dimensions (H x L x W)	mm		95 x 26.5 x 82.5
Pole weight	g		240

Technical data

S800PV

Typical internal resistances and power losses at 25 °C ambient temperature (per pole)

3

Rated current I_n [A]	Internal resistance R_i [mΩ]		Power loss P_v [W]	
	PV-SP	PV-SD	PV-SP	PV-SD
10	15.2		1.5	
13	12.1		2.0	
16	12.1		3.1	
20	8.7		3.5	
25	6.8		4.3	
32	3.1	1.8	3.2	1.8
40	2.3		3.7	
50	1.7		4.3	
63	1.6	0.9	6.4	3.6
80	1.0		6.4	
100	0.8		8.0	
125	0.6	0.5	9.4	7.8

For the effects of temperatures not given in the above table, please get in touch with your ABB contact.

Technical data

Performance at different ambient temperatures

Derating of load capability of S800

The table refers to the product standard IEC 60947-2. These values are only valid if the mounting conditions are similar to the IEC 60947-2.

The rated value of the current of the S800 refers to a calibration temperature of 30 °C for characteristics B, C and D.

For characteristics K, UCK and PV-SP it refers to 40 °C and the UL-version (S800U) refers to a calibration temperature of 25 °C.

Max. operating current depending on the ambient temperature of S800 with characteristic B, C, D, UCB

B, C, D, PV- S, UCB	Ambient temperature (°C)																					
	In [A]	-25	-20	-15	-10	-5	0	5	10	15	20	25	30	35	40	45	50	55	60	65	70	75
6	7.2	7.1	7.0	6.9	6.8	6.7	6.6	6.4	6.3	6.2	6.1	6.0	5.9	5.8	5.7	5.6	5.4	5.3	5.2	5.1	5.0	
8	9.6	9.5	9.3	9.2	9.0	8.9	8.7	8.6	8.4	8.3	8.1	8.0	7.9	7.7	7.6	7.4	7.3	7.1	7.0	6.8	6.7	
10	12.0	11.8	11.7	11.5	11.3	11.1	10.9	10.7	10.6	10.4	10.2	10.0	9.8	9.6	9.4	9.3	9.1	8.9	8.7	8.5	8.3	
13	15.6	15.4	15.1	14.9	14.7	14.4	14.2	14.0	13.7	13.5	13.2	13.0	12.8	12.5	12.3	12.0	11.8	11.6	11.3	11.1	10.9	
16	19.2	18.9	18.6	18.3	18.1	17.8	17.5	17.2	16.9	16.6	16.3	16.0	15.7	15.4	15.1	14.8	14.5	14.2	13.9	13.7	13.4	
20	24.0	23.7	23.3	22.9	22.6	22.2	21.8	21.5	21.1	20.7	20.4	20.0	19.6	19.3	18.9	18.5	18.2	17.8	17.4	17.1	16.7	
25	30.0	29.6	29.1	28.7	28.2	27.8	27.3	26.8	26.4	25.9	25.5	25.0	24.5	24.1	23.6	23.2	22.7	22.2	21.8	21.3	20.9	
32	38.5	37.9	37.3	36.7	36.1	35.5	34.9	34.3	33.8	33.2	32.6	32.0	31.4	30.8	30.2	29.7	29.1	28.5	27.9	27.3	26.7	
40	48.1	47.3	46.6	45.9	45.1	44.4	43.7	42.9	42.2	41.5	40.7	40.0	39.3	38.5	37.8	37.1	36.3	35.6	34.9	34.1	33.4	
50	60.1	59.2	58.3	57.3	56.4	55.5	54.6	53.7	52.8	51.8	50.9	50.0	49.1	48.2	47.2	46.3	45.4	44.5	43.6	42.7	41.7	
63	75.7	74.6	73.4	72.2	71.1	69.9	68.8	67.6	66.5	65.3	64.2	63.0	61.8	60.7	59.5	58.4	57.2	56.1	54.9	53.8	52.6	
80	96.1	94.7	93.2	91.7	90.3	88.8	87.3	85.9	84.4	82.9	81.5	80.0	78.5	77.1	75.6	74.1	72.7	71.2	69.7	68.3	66.8	
100		118.4	116.5	114.7	112.8	111.0		107.3			101.8		98.2	96.3	94.5	92.7	90.8	89.0	87.2	85.3	83.5	
125		147.9			141.1				131.9		127.3		122.7		118.1	115.8	113.5	111.2				

Max. operating current depending on the ambient temperature of S800 with characteristic K, UCK and PV-SP

K, UCK	Ambient temperature [°C]																					
	In [A]	-25	-20	-15	-10	-5	0	5	10	15	20	25	30	35	40	45	50	55	60	65	70	75
6	7.43	7.32	7.21	7.10	6.99	6.88	6.77	6.66	6.55	6.44	6.33	6.22	6.11	6.00	5.89	5.78	5.67	5.56	5.45	5.34	5.23	
8	9.91	9.76	9.61	9.47	9.32	9.17	9.03	8.88	8.73	8.59	8.44	8.29	8.15	8.00	7.85	7.71	7.56	7.41	7.27	7.12	6.97	
10	12.4	12.2	12.0	11.8	11.7	11.5	11.3	11.1	10.9	10.7	10.6	10.4	10.2	10.0	9.8	9.6	9.4	9.3	9.1	8.9	8.7	
13	16.1	15.9	15.6	15.4	15.1	14.9	14.7	14.4	14.2	14.0	13.7	13.5	13.2	13.0	12.8	12.5	12.3	12.0	11.8	11.6	11.3	
16	19.8	19.5	19.2	18.9	18.6	18.3	18.1	17.8	17.5	17.2	16.9	16.6	16.3	16.0	15.7	15.4	15.1	14.8	14.5	14.2	13.9	
20	24.8	24.4	24.0	23.7	23.3	22.9	22.6	22.2	21.8	21.5	21.1	20.7	20.4	20.0	19.6	19.3	18.9	18.5	18.2	17.8	17.4	
25	31.0	30.5	30.0	29.6	29.1	28.7	28.2	27.8	27.3	26.8	26.4	25.9	25.5	25.0	24.5	24.1	23.6	23.2	22.7	22.2	21.8	
32	39.6	39.0	38.5	37.9	37.3	36.7	36.1	35.5	34.9	34.3	33.8	33.2	32.6	32.0	31.4	30.8	30.2	29.7	29.1	28.5	27.9	
40	49.5	48.8	48.1	47.3	46.6	45.9	45.1	44.4	43.7	42.9	42.2	41.5	40.7	40.0	39.3	38.5	37.8	37.1	36.3	35.6	34.9	
50	61.9	61.0	60.1	59.2	58.3	57.3	56.4	55.5	54.6	53.7	52.8	51.8	50.9	50.0	49.1	48.2	47.2	46.3	45.4	44.5	43.6	
63	78.0	76.9	75.7	74.6	73.4	72.2	71.1	69.9	68.8	67.6	66.5	65.3	64.2	63.0	61.8	60.7	59.5	58.4	57.2	56.1	54.9	
80	99.1	97.6	96.1	94.7	93.2	91.7	90.3	88.8	87.3	85.9	84.4	82.9	81.5	80.0	78.5	77.1	75.6	74.1	72.7	71.2	69.7	
100					114.7		111.0								98.2	96.3	94.5	92.7	90.8	89.0	87.2	
125				147.9			141.1										118.1				111.2	

Technical data

Performance at different ambient temperatures

Max. operating current depending on the ambient temperature of S800U-K, -Z, -UCZ, -PVS5

U-K, Z, In [A]	Ambient temperature [°C]																				
	-25	-20	-15	-10	-5	0	5	10	15	20	25	30	35	40	45	50	55	60	65	70	75
5	5.9	5.8	5.7	5.6	5.6	5.5	5.4	5.3	5.2	5.1	5.0	4.9	4.8	4.7	4.6	4.5	4.4	4.4	4.3	4.2	4.1
10	11.8	11.7	11.5	11.3	11.1	10.9	10.7	10.6	10.4	10.2	10.0	9.8	9.6	9.4	9.3	9.1	8.9	8.7	8.5	8.3	8.2
13	15.4	15.1	14.9	14.7	14.4	14.2	14.0	13.7	13.5	13.2	13.0	12.8	12.5	12.3	12.0	11.8	11.6	11.3	11.1	10.9	10.6
16	18.9	18.6	18.3	18.1	17.8	17.5	17.2	16.9	16.6	16.3	16.0	15.7	15.4	15.1	14.8	14.5	14.2	13.9	13.7	13.4	13.1
20	23.7	23.3	22.9	22.6	22.2	21.8	21.5	21.1	20.7	20.4	20.0	19.6	19.3	18.9	18.5	18.2	17.8	17.4	17.1	16.7	16.3
25	29.6	29.1	28.7	28.2	27.8	27.3	26.8	26.4	25.9	25.5	25.0	24.5	24.1	23.6	23.2	22.7	22.2	21.8	21.3	20.9	20.4
32	37.9	37.3	36.7	36.1	35.5	34.9	34.3	33.8	33.2	32.6	32.0	31.4	30.8	30.2	29.7	29.1	28.5	27.9	27.3	26.7	26.1
40	47.3	46.6	45.9	45.1	44.4	43.7	42.9	42.2	41.5	40.7	40.0	39.3	38.5	37.8	37.1	36.3	35.6	34.9	34.1	33.4	32.7
50	59.2	58.3	57.3	56.4	55.5	54.6	53.7	52.8	51.8	50.9	50.0	49.1	48.2	47.2	46.3	45.4	44.5	43.6	42.7	41.7	40.8
63	74.6	73.4	72.2	71.1	69.9	68.8	67.6	66.5	65.3	64.2	63.0	61.8	60.7	59.5	58.4	57.2	56.1	54.9	53.8	52.6	51.4
80	94.7	93.2	91.7	90.3	88.8	87.3	85.9	84.4	82.9	81.5	80.0	78.5	77.1	75.6	74.1	72.7	71.2	69.7	68.3	66.8	65.3
100	118.4	116.5	114.7	112.8	111.0		107.3			101.8		98.2	96.3	94.5	92.7	90.8	89.0	87.2	85.3	83.5	81.7
125	147.9		141.1					131.9		127.3				118.1	115.8	113.5	111.2				102.1

Influence of mounting distances between the devices

Multiply the rated current referring to your max. occurent temperature with the factor of "influence of mounting distances"

Example: 2 x S802B-B125 at T= 35 °C with 5 mm distance

$$I_n = 120.4 \text{ A} \times 92.1 \% = 110.9 \text{ A}$$

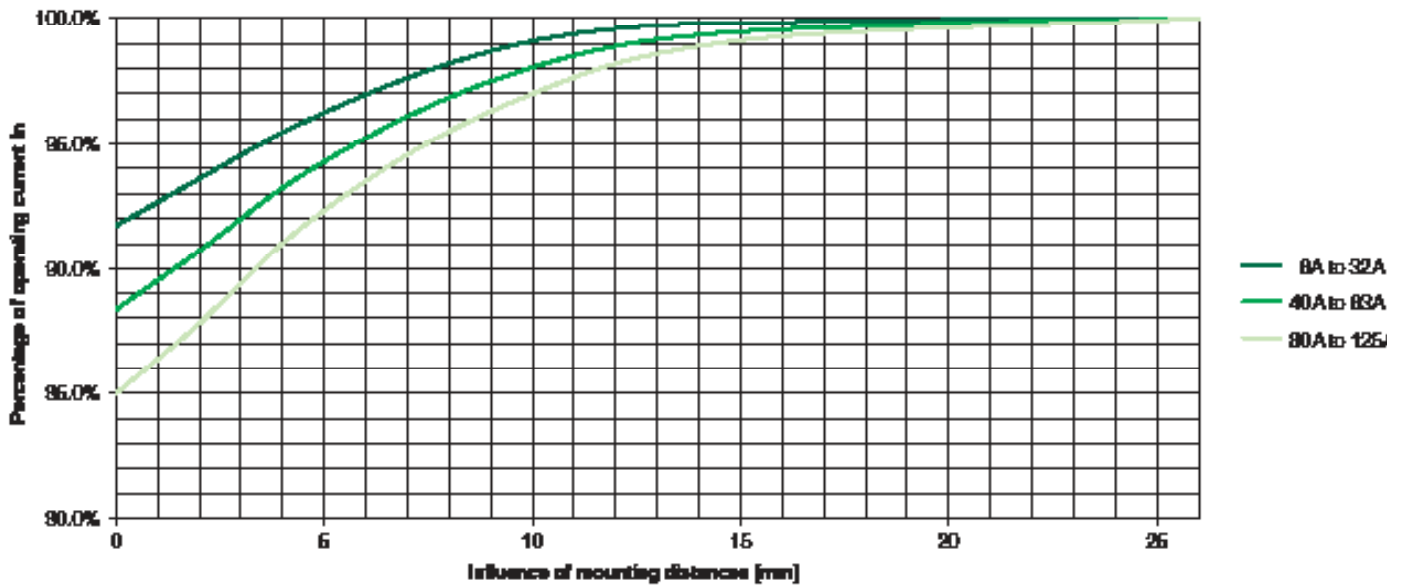

Further influencing factors, which can lead to a reduction of the maximum operating current, are:

- Shortening the cable length compared to IEC 60947-1/-2
- Reducing the cable cross section compared to IEC 60947-1/-2
- Accumulation of cables

Technical data

Accessories

Auxiliary contact S800-AUX

Utilisation categories compliant to IEC 60947-5-1		AC15 400/2A AC15 240/6A DC13 250/0.55A DC13 125V/1.1A DC13 60V/2A DC13 24V/4A
Rated values compliant to UL 489		125 VAC 6A 250 VAC 5A 24 VDC 4A 125 VDC 0.3A 250 VDC 0.15A
Conventional free air thermal current I_{th}	A	6
Minimum operational current I_{min}	mA	3
Minimum operational voltage U_{min}	V	24
Rated insulation voltage U_i	V	690
Number of contacts		2
Rated impulse withstand voltage U_{imp}	kV	6
Pollution degree		3
Standard		IEC 60947-5-1 / UL 489
Contact function		Changeover contact
Connection C_u	mm ²	1 x 2.5 2 x 1.5 14 AWG
Tightening torque	Nm	1
AC/DC feed		any
Mounting on DIN top hat rail		EN 60715
Protection category		IP20
Permissible operating ambient temperature	°C	-25 ... +60
Storage temperature	°C	-40 ... +70
Mech. lifetime of device		6000 switching cycles
I_{cu}	A	1000
Vibration resistance		IEC 60068-2-6; EN 61373 Cat.1/Class B 5g, 20 frequency cycle 5 ... 150 ... 5 Hz at 24 V AC/DC, 5 mA short-term interruption <10 ms

Technical data

Accessories

Combined auxiliary and signal contact S800-AUX/ALT

Utilisation categories compliant to IEC 60947-5-1		AC15 400/2 A AC15 240/6 A DC13 250/0.55 A DC13 125 V/1.1 A DC13 60 V/2 A DC13 24 V/4 A
Rated values compliant to UL 489		125 VAC 6 A 250 VAC 5 A 24 VDC 4 A 125 VDC 0.3 A 250 VDC 0.15 A
Conventional free air thermal current I_{th}	A	6
Minimum operational I_{min}	mA	3
Minimum operational voltage U_{min}	V	24
Rated insulation voltage U_i	A	690
Number of contacts		2 (1x AUX, 1x AUX/ALT)
Rated impulse withstand voltage U_{imp}	kV	6
Pollution degree		3
Standard		IEC 60947-5-1 / UL 489
Contact function		Changeover contact
Connection C_u	mm ²	1 x 2.5 2 x 1.5 14 AWG
Tightening torque	Nm	1
AC/DC feed.		any
Mounting on DIN top hat rail		EN 60715
Protection category		IP20
Permissible operating ambient temperature	°C	-25 ... +60
Storage temperature	°C	-40 ... +70
Mech. lifetime of device		6000 switching cycles
I_{cu} mit S450E	A	1000
Vibration resistance		IEC 60068-2-6; EN 61373 Cat.1/Class B 5g, 20 frequency cycle 5 ... 150 ... 5 Hz at 24 V AC/DC, 5 mA short-term interruption <10 ms

S800-RSU-H IEC version S800W-RSU World version Remote Switching Units for High Performance MCB

Operating Voltage		24 VDC
Current Consumption I_{rms}	A	2.5
Stand-by Current	mA	< 50
Switching Time OFF-ON	ms	< 500
Switching Time ON-OFF	ms	< 250
Ambient Operation Temperature	°C	-25 ... 70
Switching Cycles over Lifetime		10.000
Standard		IEC 60947-2 Annex N
Protection		IP20
Weight	g	300
Connection		10 pole Micro Fit 3.0

Technical data

Accessories

Short-circuit current limiter S803S-SCL

Rated operational current I_e	A	32, 63, 125
Pole		3
Rated operational voltage U_e (AC) 50/60 Hz	V	400/690
Rated insulation voltage U_i	V	690
Rated impulse withstand voltage U_{imp}	kV	8
Rated ultimate short-circuit breaking capacity I_{cu} compliant to IEC 60947-2		
400 VAC	kA	100
440 VAC	kA	100
690 VAC	kA	50
Rated service short-circuit breaking capacity I_{cs} compliant to IEC 60947-2		100% I_{cu}
Rated frequency	Hz	50/60
Mounting position		any
Disconnecter properties compliant to IEC 60947-2		yes
Standard		IEC 60947-2
Connections C_u (32 A)	mm ²	1...25 strand 1...35 cable
Connections C_u (63, 125 A)	mm ²	6...50 strand 6...70 cable
Tightening torque	Nm	3.5
Feed		any
Mounting on DIN top hat rail		EN 60715
Permissible operating ambient temperature	°C	-25 ... +60
Storage temperature	°C	-40 ... +70
Protection category		IP20 IP40 (actuating end only)
Classification compliant to NF-16-101, NF16-102		I3, F2
Vibration resistance		IEC 60068-2-27; IEC 60068-2; EN 61373 Cat.1/Class B

For permitted combinations, visit: <http://www.abb.com/product>

Low voltage products/installation devices/high performance circuit breakers/software

Rated current I_n [A]	Internal resistance R_i [mΩ]	Power loss P_v [W]
32	1.7	1.7
63	1.0	4.0
125	0.6	9.4

Technical data

Accessories

Self-resetting short-circuit current limiter

			S800S-SCL-SR	S803W-SCL-SR
Rated operational current I_e	A		32, 63, 100	
Pole			1, 2, 3	3
Rated operational voltage U_e				
(AC) according to IEC 60947-2	50/60 Hz	V	400/690	690
(AC) according to UL 508	50/60 Hz	V		600
Rated insulation voltage U_i		V		690
Rated impulse withstand voltage U_{imp}		kV		8
Rated ultimate short-circuit breaking capacity				
$I_{cu} = I_{cs}$ according to IEC 60947-2 *				
(AC) 50/60 Hz 240/415 V		kA		100
(AC) 50/60 Hz 254/440 V		kA		100
(AC) 50/60 Hz 289/500 V		kA		65
(AC) 50/60 Hz 400/690 V		kA		50
Short-circuit rating according to UL 508 *				
(AC) 50/60 Hz 480 V		kA		65
(AC) 50/60 Hz 600 V		kA		65
*) Valid only for approved combinations Please have a look to separate coordination tables on pages 3/24 and 3/25				
Rated frequency		Hz		50/60
Mounting position				any
Connections C_u				
		mm ²	1 ... 50 rigid (solid/stranded)	
		mm ²	1 ... 70 flexible	
				14-1 AWG
Tightening torque				
		Nm		3.5
		in. lbs.		31
Feeding				optional
Mouting on DIN top hat rail				EN 60715
Ambient air temperature		°C		-40 ... +70
Storage temperature		°C		-40 ... +85
Degree of protection				IP20
Classification acc. to NF F 16-101, NF F 16-102				I3, F2
Damp Heat				IEC 60068-2-30, 55 °C / 95 % r.h.
Vibration				IEC 60068-2-6, 5-10 Hz / 3 mm and 10-500 Hz / 2 g at 0.5 x I_e
Random Vibration				IEC 60068-2-64, 5-500 Hz / 2 g at 0.5 x I_e
Resistance to climatic conditions				IEC 60068-2-1 /-2-2 /-2-30
Standard			IEC 60947-2 IEC 60947-4-1	IEC 60947-2 IEC 60947-4-1 UL 508, CSA 22.2 No. 14

Technical data

S803HV-SCL-SR



S803HV-SCL-SR in combination with S803HV-K

General data

Standard		IEC 60947-2
Poles		3
Rated frequency f	Hz	50/60
Data acc. to IEC 60947-2		
Rated operational voltage U_e	V	AC 580/1000
Rated operational current I_n	A	32, 63, 100
Rated ultimate short-circuit breaking capacity I_{cu}	kA	15
Rated service short-circuit capacity I_{cs}	kA	10
Rated insulation voltage U_i	V	AC 1000
Rated impulse withstand voltage U_{imp}	kV	8

Mechanical data

Housing		Material group I, RAL 7035
Toggle		black, lockable
Protection degree acc. to IEC / EN 60529		IP20; IP40 (actuating side only)
Classification acc. to NF F16-101, NF F 16-102		I3, F2
Classification acc. to IEC 61373 (shock and vibration)		Cat. 1, Class B
Shock resistance acc. to IEC / EN 60068-2-27		Test Ea: 5 g / 30 ms
Vibration resistance acc. to IEC / EN 60068-2-6		Test Fc: 2–13.2 Hz / 1 mm 13.2–100 Hz / 0.7 g with load 100 % x I_e
Environmental conditions (damp heat) acc. to IEC / EN 60068-2-30 90–96 % RH		12+12 cycle with 55 °C / and 25 °C / 95–100 % RH
Environmental conditions (dry heat) acc. to IEC / EN 60068-2-2 70 °C / 55 % RH		16 hours 55 °C / 2 hours
Ambient temperature	°C	–25 ... +60
Storage temperature	°C	–40 ... +70

Installation

Terminal		Failsafe cage terminal
Connection (top/bottom) – Cu only	mm ²	1 ... 50 solid / stranded 1 ... 70 flexible
Tightening torque	Nm	3.5
Screwdriver		POZI 2
Mounting		EN 60715
Mounting position		any
Supply side		any

Dimension and weight

Pole dimension (H x L x W)	mm	142 x 76.5 x 26.5
Pole weight	kg	0.25

Internal resistance at 25 °C ambient temperature and nominal power losses

Rated operational current I_n [A]	Internal resistance R_i [mΩ]	Power losses P_m [W]
32	2.8	3.6
63	1.3	5.7
100	0.7	7.8

Technical data

Accessories

Internal resistance at 25°C ambient temperature and nominal power losses

Rated operational current I_e [A]	Internal resistance R_i [mΩ]	Power losses P_{vn} [W]
32	2.8	3.6
63	1.3	5.7
100	0.7	7.8

3

Influence of ambient temperature – single mounted devices

Rated operational current I_e [A]	10°C	15°C	20°C	25°C	30°C	35°C	40°C	45°C	50°C	55°C	60°C	65°C	70°C
32	38.2	37.2	35.8	35.2	34.2	33.3	32	30.7	29.8	28.8	27.8	26.5	25.1
63	75.3	73.2	70.6	69.3	67.4	65.5	63	60.5	58.6	56.7	54.8	52.3	49.8
100	119.5	116.2	112	110	107	104	100	96	93	90	87	84	80

Maximum load

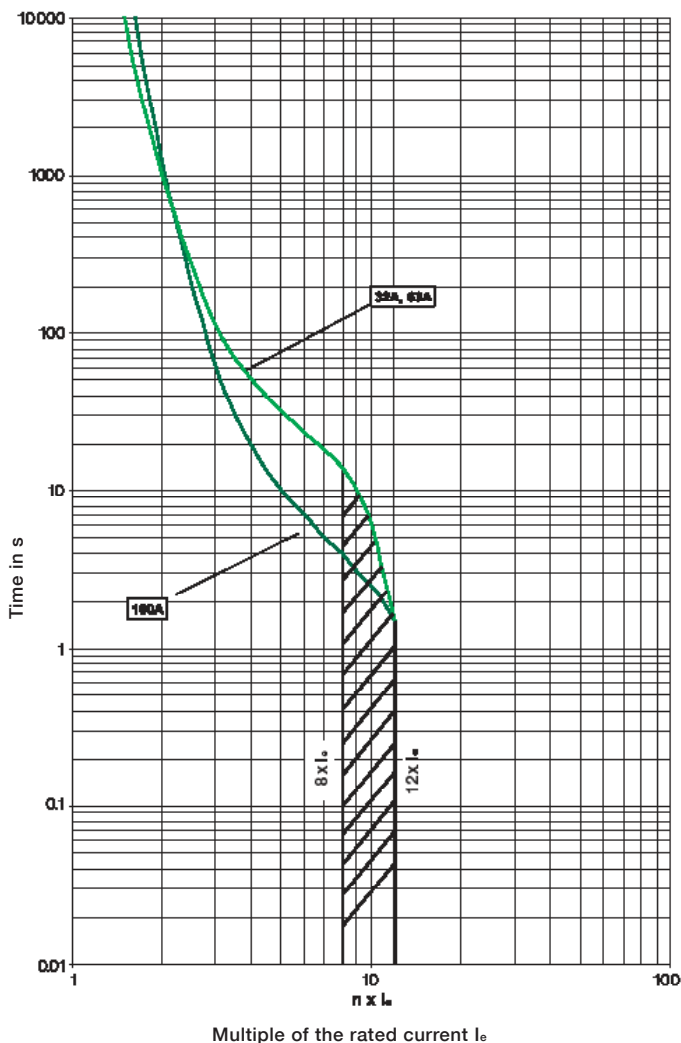

Installation requirements

The total sum of the rated currents of all downstream motor starters or circuit breakers shall not exceed the rated current of the S800-SCL-SR (valid also for HV version). Furthermore the sum of all load currents including inrush currents shall not exceed the maximum permissible load of the S800-SCL-SR (valid also for HV version).

Approved combinations

S800-SCL-SR/S803S-SCL with S800 and motor starters

A new web tool SOC - Selected Optimized Coordination is now available at http://applications.it.abb.com/SOC_SNB and can be used to find all the available combinations between S800 portfolio and other ABB devices:

- Motor starting and protection
- Selectivity among protection devices
- Back-up among protection devices
- Protection of other equipments like switch-disconnectors

Approved combinations with high performance MCB S800

Downstream devices	Upstream devices					
	S800S-SCL-SR/S803W-SCL-SR Self resetting short-circuit limiter			S803S-SCL Short-circuit limiter		
	32	63	100	32	63	125
Rated current I_e [A]						
S800S Characteristic B						
6	?					
8	?					
10	?	?	?	?		
13	?	?	?	?		
16	?	?	?	?		
20	?	?	?	?		
25	?	?	?	?		
32	?	?	?	?	?	
40		?	?		?	
50		?	?		?	
63		?	?		?	?
80			?			?
100			?			?
125						?
S800S Characteristic C						
6	?					
8	?					
10	?	?	?	?		
13	?	?	?	?		
16	?	?	?	?		
20	?	?	?	?		
25	?	?	?	?		
32		?	?	?	?	
40		?	?		?	
50		?	?		?	
63			?		?	?
80			?			?
100						?
125						?
S800S Characteristic D/K						
6	?					
8	?					
10	?	?	?	?		
13	?	?	?	?		
16	?	?	?	?		
20		?	?	?		
25		?	?	?		
32		?	?	?	?	
40		?	?		?	
50			?		?	
63			?		?	?
80						?
100						?
125						?

Approved combinations

S800-SCL-SR/S803S-SCL with S800 and motor starters

Approved combinations with motor starter/S800S-KM

Downstream devices	Upstream devices					
	S800S-SCL-SR/S803W-SCL-SR Self resetting short-circuit limiter			S803S-SCL Short-circuit limiter		
Rated current I _e [A]	32	63	100	32	63	125
MS/MO325						
0.1–2.5	☑	☑	☑			
4	☑	☑	☑			
6.3	☑	☑	☑			
9	☑	☑	☑	☑	☑	
12.5	☑	☑	☑	☑	☑	
16	☑	☑	☑	☑	☑	
20		☑	☑	☑	☑	
25		☑	☑	☑	☑	
MS/MO132						
0.1–2.5	☑	☑				
4	☑	☑				
6.3	☑	☑	☑			
10	☑	☑	☑	☑	☑	
16	☑	☑	☑	☑	☑	
20		☑	☑	☑	☑	
25		☑	☑	☑	☑	
32		☑	☑	☑	☑	
MS132-T						
0.1–2.5	☑	☑				
4	☑	☑				
6.3	☑	☑	☑			
10	☑	☑	☑	☑	☑	
12	☑	☑	☑	☑	☑	
16		☑	☑	☑	☑	
20		☑	☑	☑	☑	
25		☑	☑	☑	☑	
S800S-KM						
20		☑	☑	☑		
25		☑	☑	☑		
32		☑	☑	☑	☑	
40		☑	☑		☑	
50			☑		☑	
63					☑	☑
80						☑

* Motor starter combinations acc. to IEC 60947-4-1

☑ Applies for all voltages according to the table below

Approved combinations S803HV-SCL-SR with S800

Approved combinations with S803HV-K

Downstream devices	Upstream devices S803HV-SCL-SR Self resetting short-circuit limiter			
	Rated operational current I_n [A]	32	63	100
S800HV Characteristic K				
6	?			
8	?			
10	?	?		?
13	?	?		?
16		?		?
20		?		?
25		?		?
32		?		?
40		?		?
50				?
63				?
80				
100				
125				

3

Applies for all voltages according to the table below

		S800S-SCL-SR	S803W-SCL-SR	S803S-SCL	S803HV-SCL-
SR					
Rated ultimate short-circuit breaking capacity					
$I_{cu} = I_{cs}$ according to IEC 60947-2					
(AC) 50/60 Hz 240/415 V	kA	100	100		
(AC) 50/60 Hz 254/440 V	kA	100	100	100	
(AC) 50/60 Hz 277/480 V	kA	65	65		
(AC) 50/60 Hz 289/500 V	kA	65	65		
(AC) 50/60 Hz 346/600 V	kA	65	65		
(AC) 50/60 Hz 400/690 V	kA	50	50	50	
(AC) 50/60 Hz 580/1000 V	kA				$I_{cu} = 15 \text{ kA}$ $I_{cs} = 10 \text{ kA}$
Short-circuit rating according to UL 508, CSA 22.2					
(AC) 50/60 Hz 480 V	kA		65		
(AC) 50/60 Hz 600 V	kA		65		

Technical data

Accessories

Shunt release S800-SOR

		S800-SOR12	S800-SOR24	S800-SOR130	S800-SOR250	S800-SOR400
Rated operational voltage U_e	VAC/DC	12	24	48 ... 130	110...250	220 ... 400
Operating range	% U_e	70 ... 110				
Rated insulation voltage U_i	V	690				
Coil pull in consumption	W/VA	15.5	16.6/17*	41.9 ... 307.3 42 ... 310*	23 ... 119 20 ... 105*	45 ... 148.1
Rated frequency	Hz	DC; 50/60				
Pollution degree		3				
Standard		IEC 60947-2/UL 489				
Connection C_u	mm ²	1 ... 25 (14-2 AWG) strand 1 ... 35 (14-3 AWG) cable				
Tightening torque	Nm	3.5				
AC/DC supply		any				
Mounting on DIN top hat rail		EN 60715				
Protection category		IP20 IP40 (actuating end only)				
Permissible operating ambient temperature	°C	-25 ... +60				
Storage temperature	°C	-40 ... +70				
Vibration resistance		IEC 60068-2-6; EN 61373 Cat.1/Class B				

3

Technical data

Accessories

Undervoltage release S800-UVR

		S800-UVR36	S800-UVR60	S800-UVR130	S800-UVR250
Rated operational voltage U_e	VAC/DC	24 ... 36	48 ... 60	110 ... 130	220 ... 250
Operating range					
open	% U_e			35 ... 70	
closed	% U_e			85	
Rated insulation voltage U_i	V			690	
Power loss of coil when attracted	W/VA	1.11 ... 1.14/1.2*	1.14 ... 1.25/1.3*	1.3 ... 1.41/1.4*	1.71 ... 1.91/1.9*
Rated frequency	Hz			DC; 50/60	
Pollution degree				3	
Standard				IEC 60947-2/UL 489	
Connection C_u	mm ²			1 ... 25 (14-2 AWG) strand 1 ... 35 (14-3 AWG) cable	
Tightening torque	Nm			3.5	
AC/DC supply				any	
Mounting on DIN top hat rail				EN 60715	
Protection category				IP20 IP40 (actuating end only)	
Permissible operating ambient temperature	°C			-25 ... +60	
Storage temperature	°C			-40 ... +70	
Vibration resistance				IEC 60068-2-6; EN 61373 Cat.1/Class B	

* compliant to UL 489.

Busbar S803-BB250/S804-BB250

Max. rated current I_n		
Side feed	A	125
Middle feed	A	250
Conditional rated short-circuit current	kA eff	100 mit T_{max} connected upstream
Poles		3/4
Rated operational voltage U_e		
(AC) 50/60 Hz	V	400/690
Rated insulation voltage U_i	V	690
Rated impulse withstand voltage U_{imp}	kV	8
Rated frequency	Hz	50
Standard		EN/IEC 60439-2
Material of rails		E-Cu 58 half-standard, rolled F25
Material of insulation profile		Material group I; UL94 V-0
Material of end caps		Material group I; UL94 V-0 Free of halogen and phosphate
Busbar cross sections	mm ²	60
Overvoltage category		III
Pollution degree		2

Technical data

Accessories

3

Feed block S803-BBPC120/S804-BBPC120

Max. rated current I_n	A	250
Poles		3/4
Rated operational voltage U_e	V	400/690
Rated frequency	Hz	50
Standard		EN/IEC 60439-2
Material of terminals		Material group I
Housing material		Material group I; UL94 V-0 Free of halogen and phosphate
Tightening torque		
on feed side	Nm	19
on busbar side	Nm	3
Connection cross-section	mm ²	1.6...120
Pollution degree		2

Pole connector S802-LINK125

Rated insulation voltage U_i	V	DC 1200
Protection category	Nm	3.5
Tightening torque	in. lbs.	31

Max. rated current as a function of ambient temperature

Combination S800PV-S with S802-LINK50 / -LINK125 (devices mounted separately)

I_e [A]	10° C	15° C	20° C	25° C	30° C	35° C	40° C	45° C	50° C	55° C	60° C
10	11.2	11	10.7	10.4	10	9.6	9.3	9	8.7	8.4	8
13	14.6	14.3	13.9	13.5	13	12.5	12.1	11.7	11.3	10.9	10.4
16	17.9	17.6	17.1	16.6	16	15.4	14.9	14.4	13.9	13.4	12.8
20	22.4	22	21.4	20.8	20	19.2	18.6	18	17.4	16.8	16
25	28	27.5	26.8	26	25	24	23.3	22.5	21.8	21	20
32	35.8	35.2	34.2	33.3	32	30.7	29.8	28.8	27.8	26.9	25.6
40	44.8	44	42.8	41.6	40	38.4	37.2	36	34.8	33.6	32
50	56	55	53.5	52	50	48	46.5	45	45	43	40
63	67.8	66.5	65.3	64.2	63.0	60.5	58.1	55.7	53.5	51.4	49.3
80	86.0	84.5	83.0	81.5	80.0	76.8	73.7	70.8	67.9	65.2	62.6
100	107.5	105.6	103.7	101.8	100.0	96.0	92.2	88.5	84.9	81.5	78.3
125	134.4	132.0	129.6	127.3	125.0	116.3	108.1	100.5	93.5	87.0	80.9

Combination S800PV-SP with S802-LINK50 / -LINK125 (devices mounted separately)

I_e [A]	10° C	15° C	20° C	25° C	30° C	35° C	40° C	45° C	50° C	55° C	60° C
10	11.6	11.4	11.2	11	10.7	10.4	10	9.6	9.3	9	8.7
13	15.1	14.9	14.6	14.3	13.9	13.5	13	12.5	12.1	11.7	11.3
16	18.6	18.2	17.9	16.6	17.1	16.6	16	15.4	14.9	14.4	13.9
20	23.2	22.8	22.4	22	21.4	20.8	20	19.2	18.6	18	17.4
25	29	28.5	28	27.5	26.8	26	25	24	23.3	22.5	21.8
32	37.1	36.5	35.8	35.2	34.2	33.3	32	30.7	29.8	28.8	27.8
40	46.5	45.6	44.8	44	42.8	41.6	40	38.4	37.2	36	34.8
50	58.1	57	56	55	53.5	52	50	48	46.5	44.6	42.9
63	69.9	68.8	67.6	66.5	65.3	64.2	63	60.5	58.1	55.7	53.5
80	88.8	87.3	86	84.4	82.9	81.5	80	76.8	73.7	70.8	67.9
100	111	109.2	107.3	105.6	103.7	101.8	100	96	92.2	88.5	
125	138.8	136.5	134.2	131.9	129.6	127.3	125	116.3	106.1	100.5	93.5

Combination S800PV-M and S800PV-SD with S802-LINK50 / -LINK125 (devices mounted separately)

I _e [A]	10° C	15° C	20° C	25° C	30° C	35° C	40° C	45° C	50° C	55° C	60° C
32	32	32	32	32	32	32	32	32	32	32	32
63	63	63	63	63	63	63	63	63	63	63	63
125	125	125	125	125	125	125	110	110	100	100	100

These values are valid for the combination with S802-LINK50

The tables are based on measurements using cable as stated in IEC 60947-2. Any derivation from these cable diameters and lengths might lead to higher temperatures. Therefore ABB recommends to perform temperature measurements to verify the real maximum temperature in the application.

CMS sensor 18 mm

Sensor type		CMS-100xx	CMS-101xx	CMS-102xx
Measurement range	A	80	40	20
Measurement values		TRMS, AC 50/60Hz, DC	TRMS, AC 50/60Hz, DC	TRMS, AC 50/60Hz, DC
Crest factor of distorted wave forms		≤ 1.5	≤ 3	≤ 6
AC Accuracy (TA = +25 °C)*		≤ 0.5 %	≤ 0.5 %	≤ 0.5 %
AC Temperature coefficient*		≤ 0.036 %	≤ 0.036 %	≤ 0.036 %
DC Accuracy (TA = +25 °C)*		≤ 0.7 %	≤ 1.0 %	≤ 1.7 %
DC Temperature coefficient*		≤ 0.047 %	≤ 0.059 %	≤ 0.084 %
Resolution	A	0.01	0.01	0.01
Sampling rate internal	Hz	5000	5000	5000
Settling time (±1 %)	sec	typ. 0.25	typ. 0.25	typ. 0.25
Cable feed through	mm	10	10	10
Insulation Voltage	V	690 VAC/1500 VDC	690 VAC/1500 VDC	690 VAC/1500 VDC
Operating temperature	[°C]	-25 ... +70	-25 ... +70	-25 ... +70
Storage temperature	[°C]	-40 ... +85	-40 ... +85	-40 ... +85
Standarts		DIN EN 61010-1	DIN EN 61010-1	DIN EN 61010-1
Overall dimensions				
CMS-100PS series	mm	17.4 x 41.0 x 26.5	17.4 x 41.0 x 26.5	17.4 x 41.0 x 26.5
CMS-100S8 series	mm	26.5 x 45.5 x 31.8	26.5 x 45.5 x 31.8	26.5 x 45.5 x 31.8
CMS-100DR series	mm	17.4 x 51.5 x 43.2	17.4 x 51.5 x 43.2	17.4 x 51.5 x 43.2
CMS-100CA series	mm	17.4 x 41.0 x 29.0	17.4 x 41.0 x 29.0	17.4 x 41.0 x 29.0

Technical data

Accessories

CMS sensor 25 mm

Sensor type		CMS-200xx	CMS-201xx	CMS-202xx
Measurement range	A	160	80	40
Measurement values		TRMS, AC 50/60Hz, DC	TRMS, AC 50/60Hz, DC	TRMS, AC 50/60Hz, DC
Crest factor of distorted wave forms		≤ 1.5	≤ 3	≤ 6
AC Accuracy (TA = +25 °C)*		≤ 0.5 %	≤ 0.5 %	≤ 0.5 %
AC Temperature coefficient*		≤ 0.036 %	≤ 0.036 %	≤ 0.036 %
DC Accuracy (TA = +25 °C)*		≤ 0.7 %	≤ 1.0 %	≤ 1.7 %
DC Temperature coefficient*		≤ 0.047 %	≤ 0.059 %	≤ 0.084 %
Resolution	A	0.01	0.01	0.01
Sampling rate internal	Hz	5000	5000	5000
Settling time (±1 %)	sec	typ. 0.25	typ. 0.25	typ. 0.25
Cable feed through	mm	15	15	15
Insulation Voltage	V	690 VAC/1500 VDC	690 VAC/1500 VDC	690 VAC/1500 VDC
Operating temperature	[°C]	-25 ... +70	-25 ... +70	-25 ... +70
Storage temperature	[°C]	-40 ... +85	-40 ... +85	-40 ... +85
Standarts		DIN EN 61010-1	DIN EN 61010-1	DIN EN 61010-1
Overall dimensions				
CMS-200S8 series	mm	26.5 x 43.0 x 38.5	26.5 x 43.0 x 38.5	26.5 x 43.0 x 38.5
CMS-200DR series	mm	25.4 x 43.0 x 43.2	25.4 x 43.0 x 43.2	25.4 x 43.0 x 43.2
CMS-200CA series	mm	25.4 x 43.0 x 35.7	25.4 x 43.0 x 35.7	25.4 x 43.0 x 35.7

* of full range

CMS Control Unit

		CMS-100xx
Supply voltage	[VDC]	24 (±10 %)
Power consumption	[W]	max. 24 W (with 64 sensors)
Interface		RS485 2-wire
Protocol		Modbus RTU
Data rate	[Baud]	2400 ... 115200
Data refresh time		≤ 1 sec for 64 sensors' results
Insulation Voltage	[V]	400 VAC
Screw-type terminals		0.5 ... 2.5 mm ² , max 0.6 Nm
Mounting		DIN-rail 35 mm acc. DIN50022 or SMISLINE TP busbar system
Dimension	[mm]	71.8 x 87.0 x 64.9 (4 DIN modules)

General Data – Sensors & Control Unit

Operating temperature	[°C]	-25 ... +70
Operating temperature	[°C]	-40 ... +85
Standards		DIN EN 61010-1

DDA-800 residual current device

		DDA800AC	DDA800A	DDA800AS	DDA800A AP-R
Standard				IEC 60947-2	
Sensitivity		AC	A	A (selective)	A (with short-term delay)
Rated current	A			100	
Number of poles				2P; 3P; 4P	
Rated insulation voltage U_i	V			690	
Rated operational voltage U_e	V			230/400; 240/415; 400/690	
Max. Rated operational voltage U_b max.	V			690	
Min. Rated operational voltage U_b min.	V			195	
Rated ultimate short-circuit breaking capacity I_{cu} compliant to IEC 60947-2				Depends on ultimate breaking capacity of MCB's	
Rated ultimate short-circuit breaking capacity $I_{\Delta m}$ with S800N	kA			Depends on ultimate breaking capacity of MCB's	
Rated ultimate short-circuit breaking capacity $I_{\Delta m}$ with S800S	kA			Depends on ultimate breaking capacity of MCB's	
Rated impulse withstand voltage U_{imp} Impulse (1.2/50)	kV			6	
Rated impulse withstand voltage U_{imp} (50...60Hz) x 1min	kV			2.5	
Max. operating voltage of test circuit	V			690	
Min. operating voltage of test circuit	V			195	
Electrical strength compliant to VDE	A		250	5000	3000
Rated frequency	Hz			50/60	
Rated residual operating current $I_{\Delta n}$	A	0.03; 0.3	0.03; 0.3; 0.5	0.3; 1	0.03
Switch lever				blue, can only be switched in OFF position	
Protection category, housing				IP4X (without terminal area)	
Protection category, terminal				IP2X	
Permissible operating ambient temperature	°C			-25 ... +60	
Permissible storage temperature	°C			-40 ... +70	
Strand connections	mm ²			6 ... 50	
Cable connections	mm ²			6 ... 70	
Tightening torque	Nm			3.5	
Fixed on mounting rail				EN 60715	

Technical data

Accessories

DS-800 RCBO

		DS800S A	DS800N A	DS800S AS	DS800N AS	DS800S AP-R	DS800N AP-R
Standard		IEC 60947-2					
Sensitivity		A		A (selective)		A (with short-term delay)	
Rated current	A	125					
Number of poles		2P; 3P; 4P		2P; 4P		2P; 3P; 4P	
Rated insulation voltage U_i	V	690					
Rated operational voltage U_e	V	230/400; 240/415; 400/690					
Max. rated operational voltage U_b max.	V	690					
Min. rated operational voltage U_b min.	V	195					
Rated ultimate short-circuit breaking capacity I_{cu} compliant to IEC 60947-2							
(AC) 50/60 Hz 240/450 V	kA	50	36	50	36	50	36
(AC) 50/60 Hz 254/440 V	kA	30	20	30	20	30	20
(AC) 50/60 Hz 289/500 V	kA	10	10	10	10	10	10
(AC) 50/60 Hz 400/690 V	kA	4.5	4.5	4.5	4.5	4.5	4.5
Rated service short-circuit breaking capacity I_{cs} compliant to IEC 60947-2							
(AC) 50/60 Hz 240/450 V	kA	40	30	40	30	40	30
(AC) 50/60 Hz 254/440 V	kA	15	10	15	10	15	10
(AC) 50/60 Hz 289/500 V	kA	5	5	5	5	5	5
(AC) 50/60 Hz 400/690 V	kA	3	3	3	3	3	3
Rated impulse withstand voltage U_{imp}	kV	6					
Impulse (1.2/50)							
Rated impulse withstand voltage U_{imp}	kV	2.5					
(50...60 Hz) x 1 min							
Max. operating voltage of test circuit	V	690					
Min. operating voltage of test circuit	V	195					
Electrical strength compliant to VDE 0432 part 2	A	250	250	5000	5000	3000	3000
Rated frequency	Hz	50/60					
Rated residual operating current $I_{\Delta n}$	A	0.3	0.3	0.3; 1	0.3; 1	0.03	0.03
Switch lever		BacI(MCB), can be connected in On-Off position + blue (RCD) only in OFF position					
Protection category, housing		IP4X					
Protection category, terminal		IP2X					
Permissible operating ambient temperature	°C	-25 ... +60					
Permissible storage temperature	°C	-40 ... +70					
Strand connections	mm ²	6 ... 50					
Cable connections	mm ²	6 ... 70					
Tightening torque	Nm	3.5					
Fixed on mounting rail		EN 60715					

230/400 V Let-through energies S800S-B, -C, -D, -K

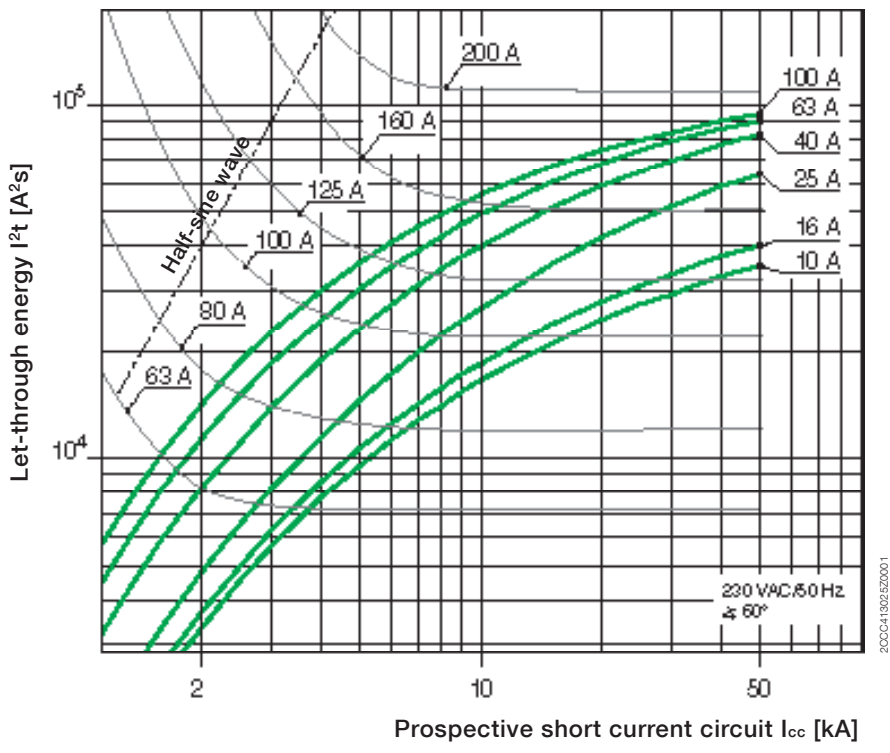
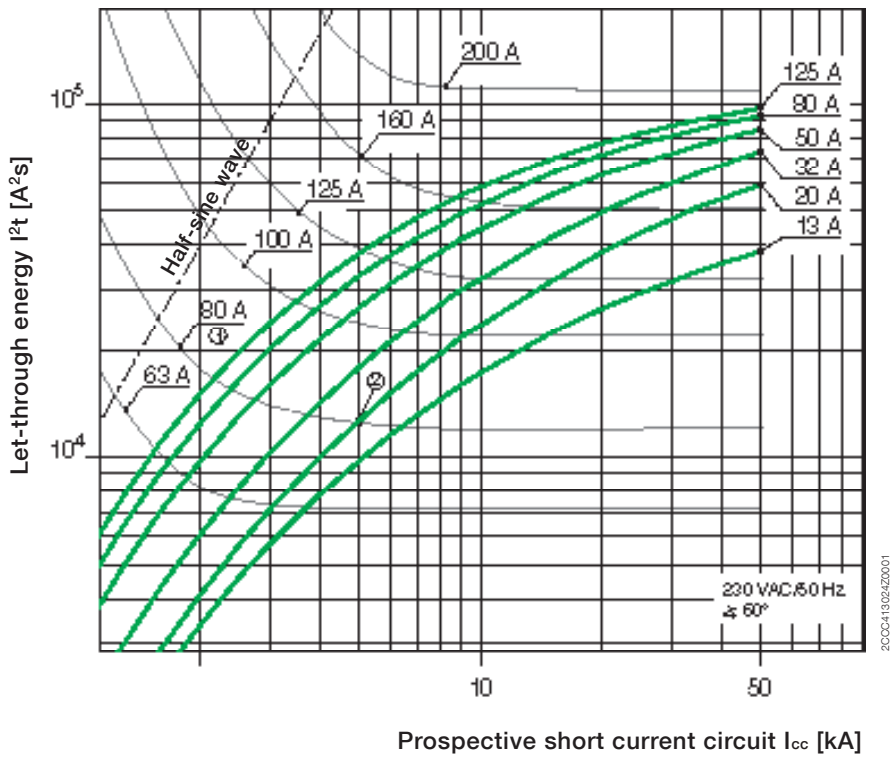

- ⊠ Min. pre-arcing I^2t , e.g. NH80A gL/gG
- ⊡ Max. let-through I^2t , e.g. S801S-C20

Selectivity with respect to the upstream fuse to the point of intersection of both curves 1 and 2, e.g. S801S-C20 to NH80A gL/gG: Selectivity up to min. 5 kA.

440 V Let-through energies S800S-B, -C, -D, -K

3

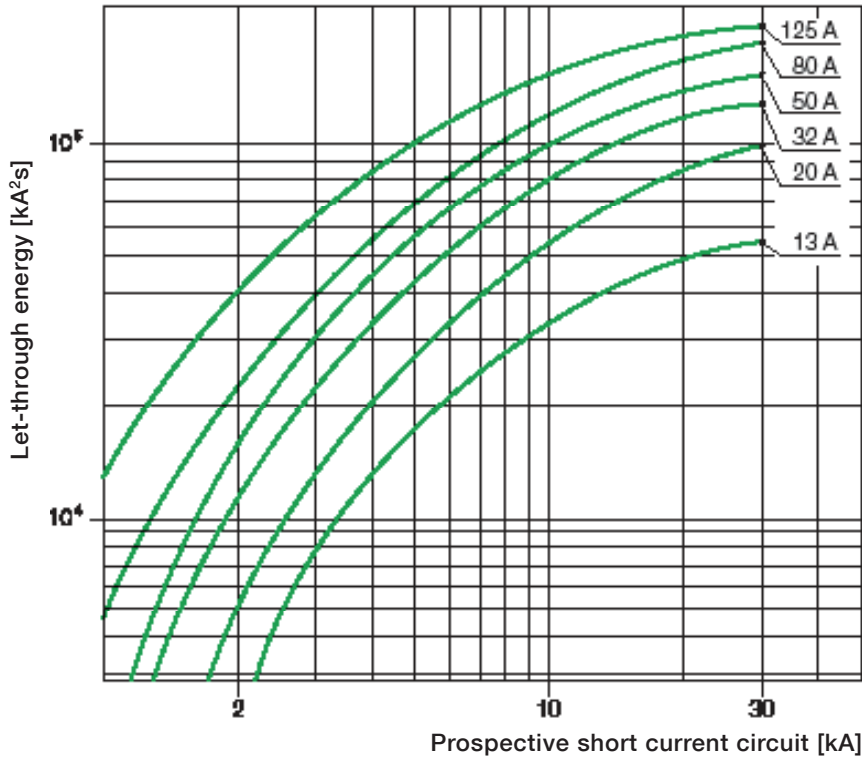

20CC41329/20001

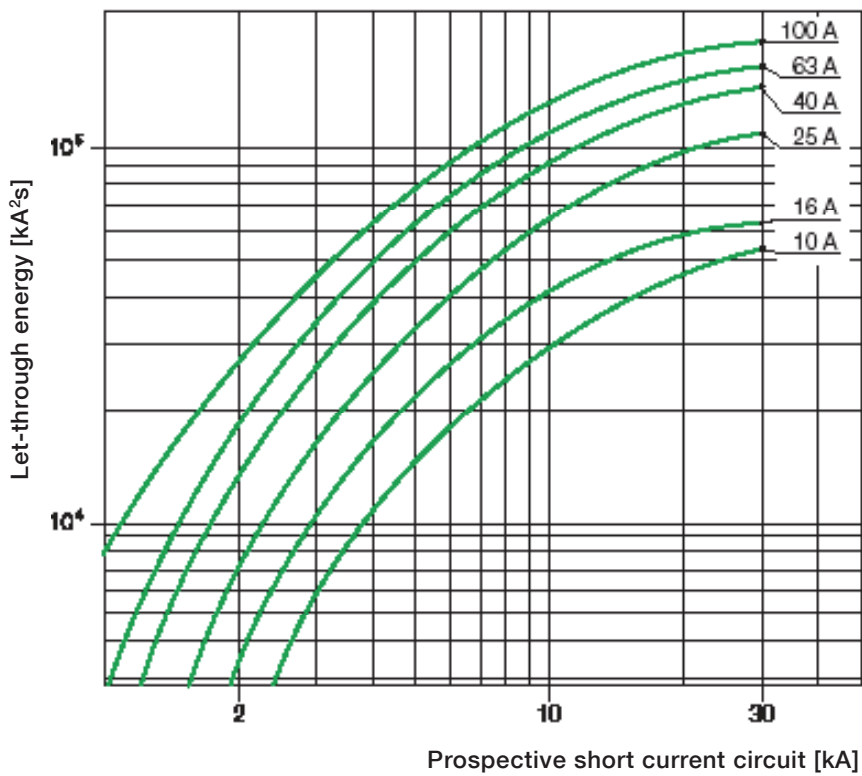

20CC41329/20001

690 V Let-through energies S800S-B, -C, -D, -K

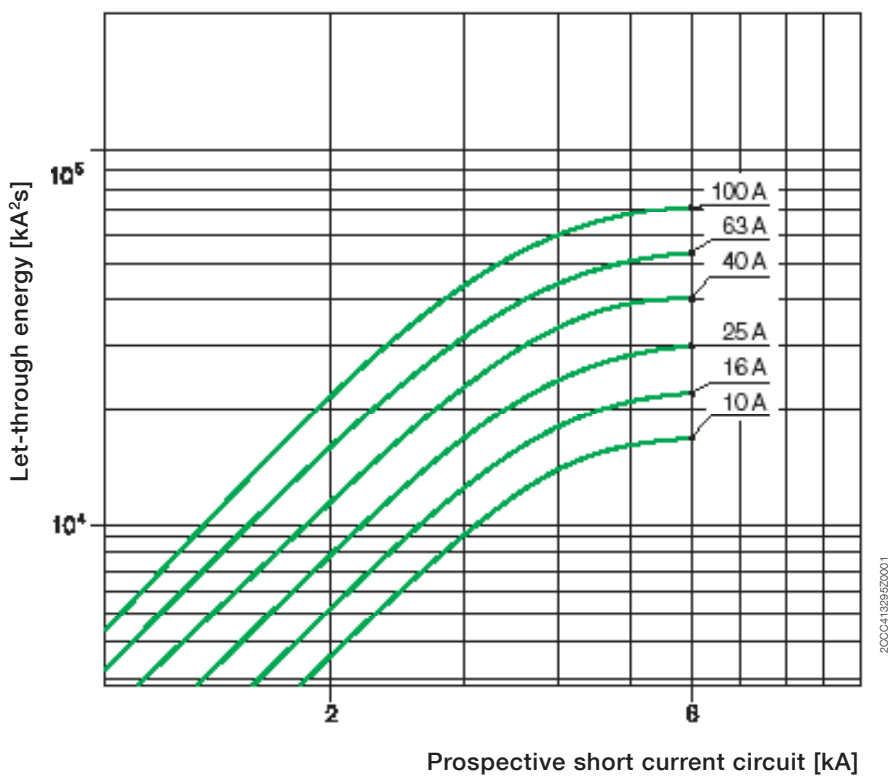
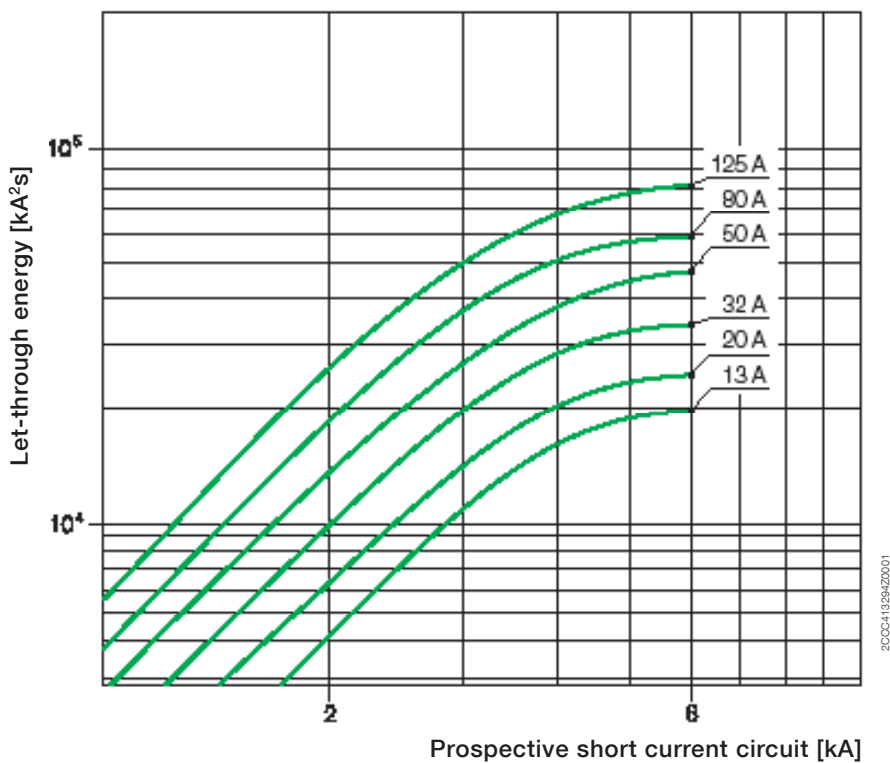

230/400 V Let-through energies S800N-B, -C, -D

3

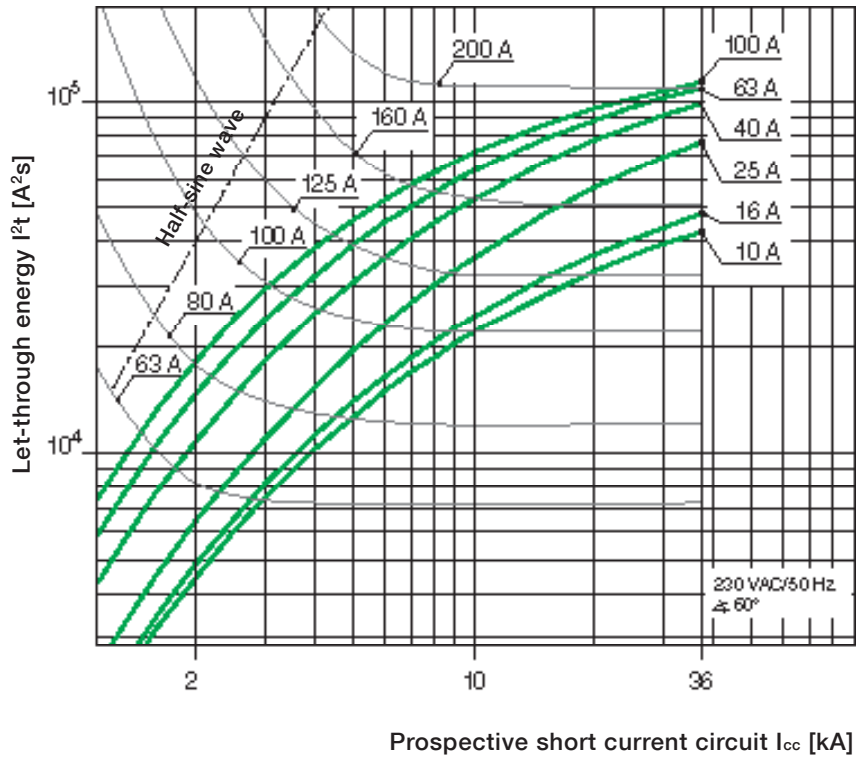
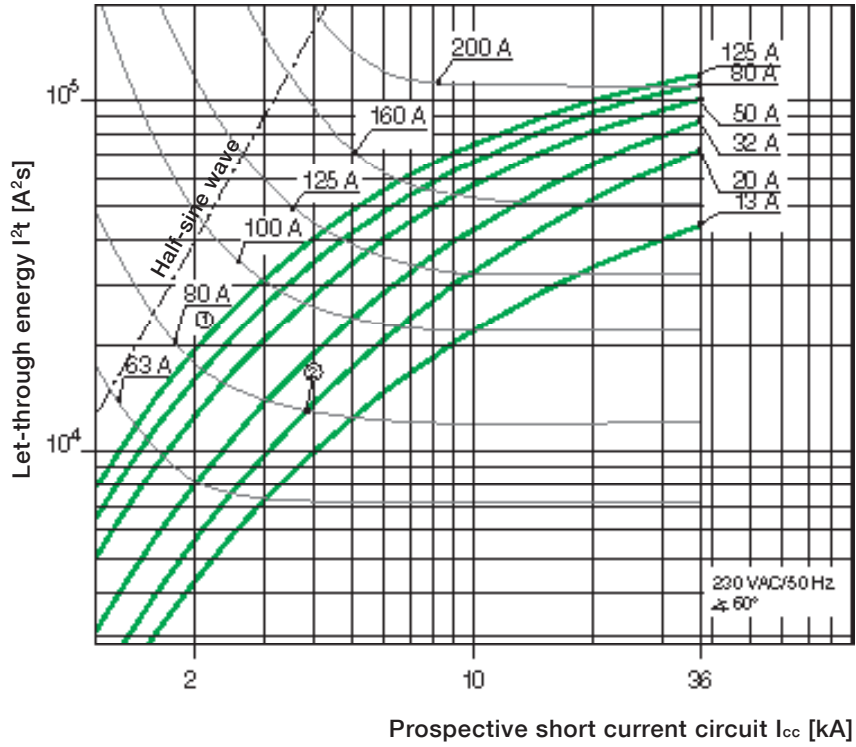

- ▣ Min. pre-arcing I^2t , e.g. NH80A gL/gG
- ▣ Max. let-through I^2t , e.g. S801N-C20

Selectivity with respect to the upstream fuse to the point of intersection of both curves 1 and 2, e.g. S801N-C20 to NH80A gL/gG: Selectivity up to min. 3.8 kA.

230/400 V Let-through energies S800C-B, -C, -D, -K

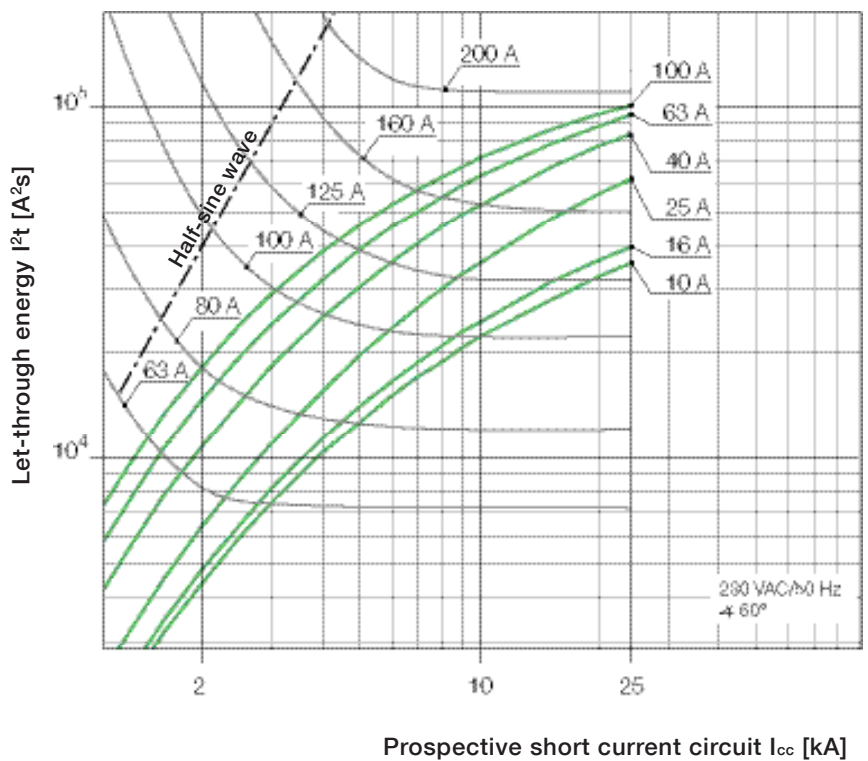
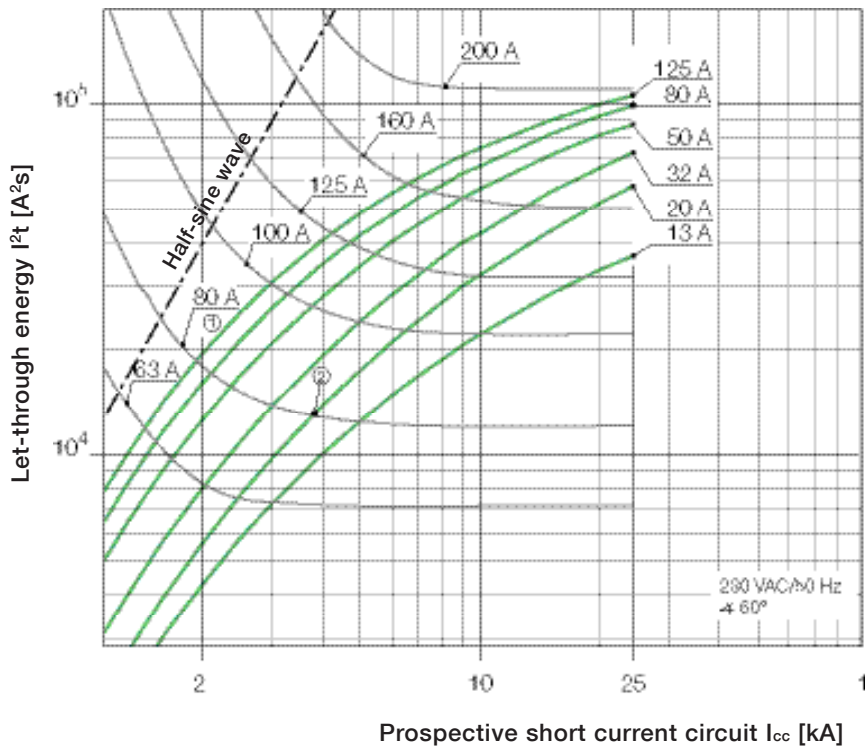

- ▣ Min. pre-arcing I^2t , e.g. NH80A gL/gG
- ▣ Max. let-through I^2t , e.g. S801C-C20

Selectivity with respect to upstream fuse to the point of intersection of both curves 1 and 2, e.g. S801C-C20 to NH80A gL/gG: Selectivity up to min. 3.8 kA

230/400 V Let-through energies S800B-B, -C, -D, -K

3

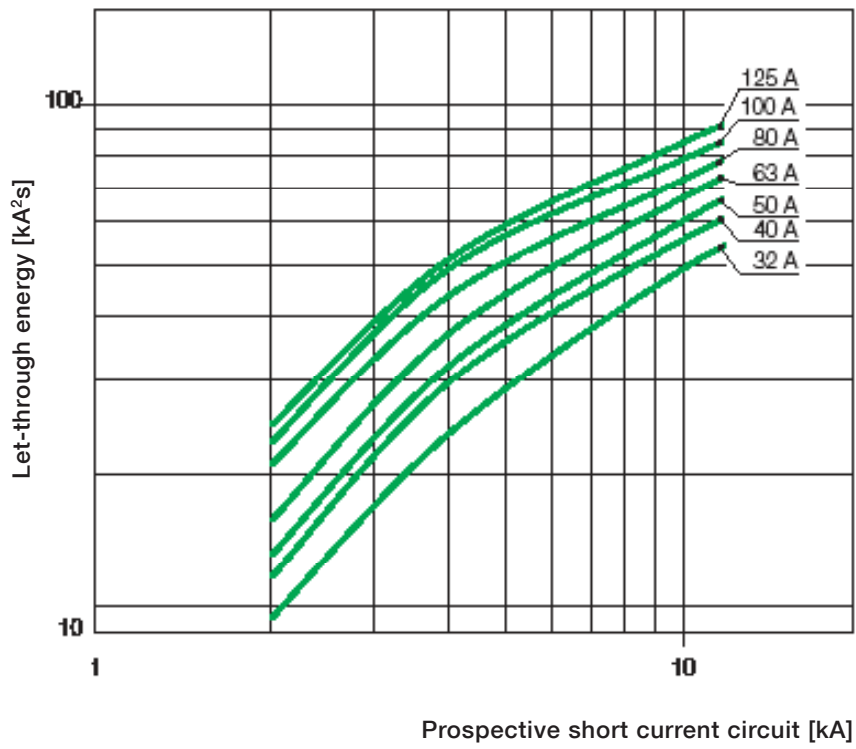

2CCC4132772001

240 V Let-through energies S800U-Z, -K

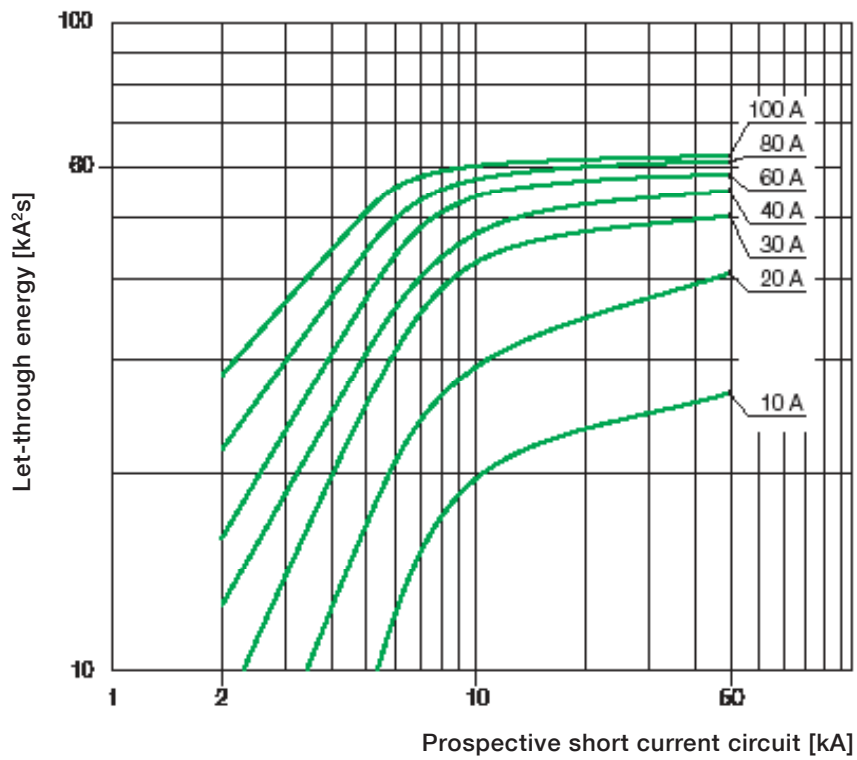

2CCC413286Z0001

230/400 V Let-through current S800S-B, -C, -D, -K

3

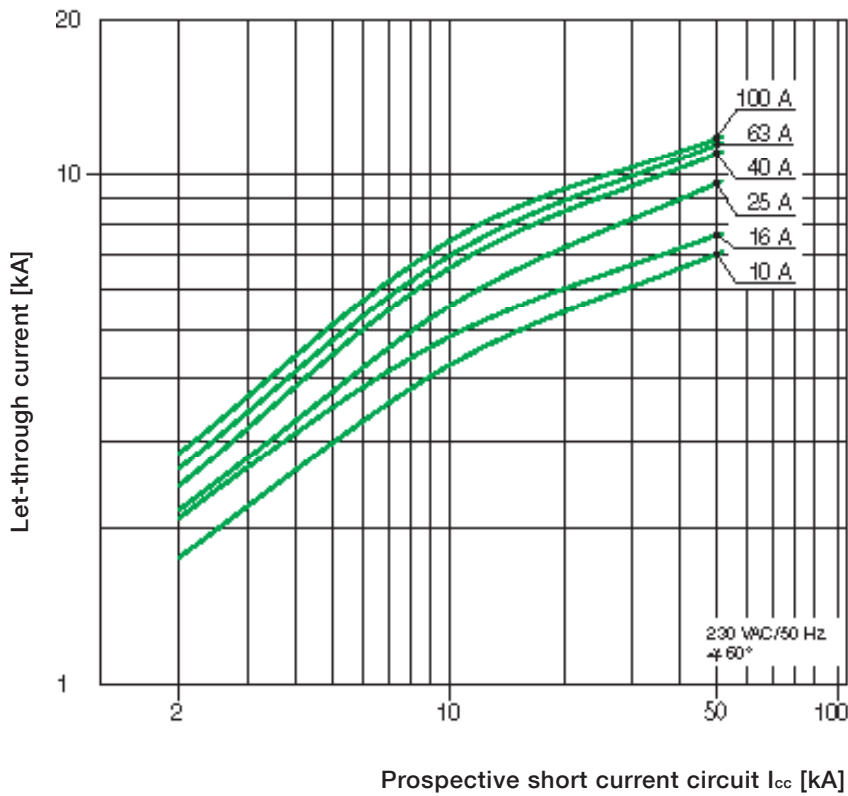
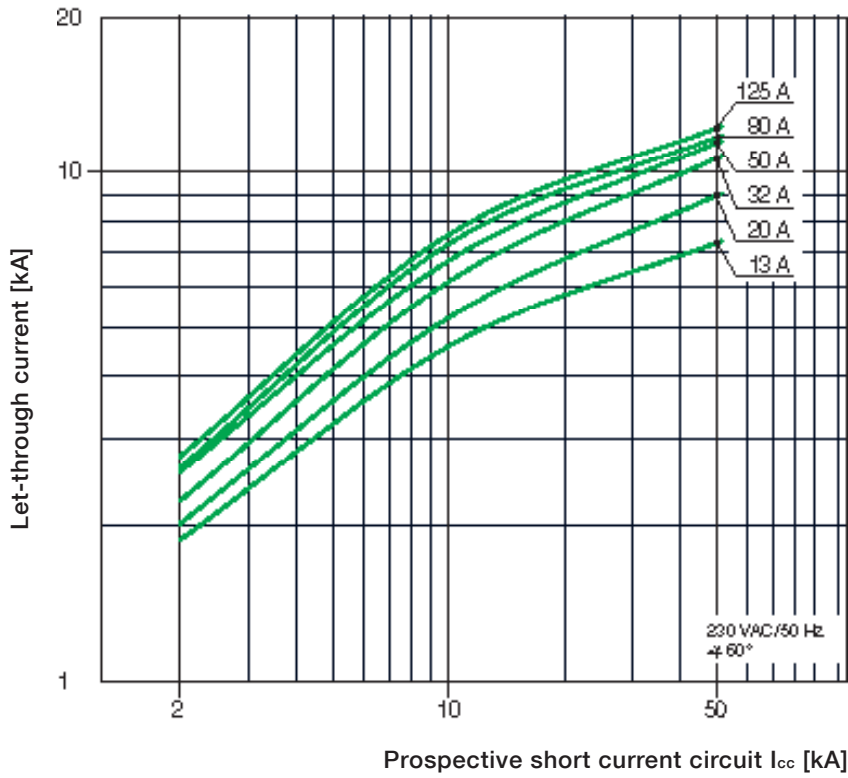

440 V Let-through current S800S-B, -C, -D, -K

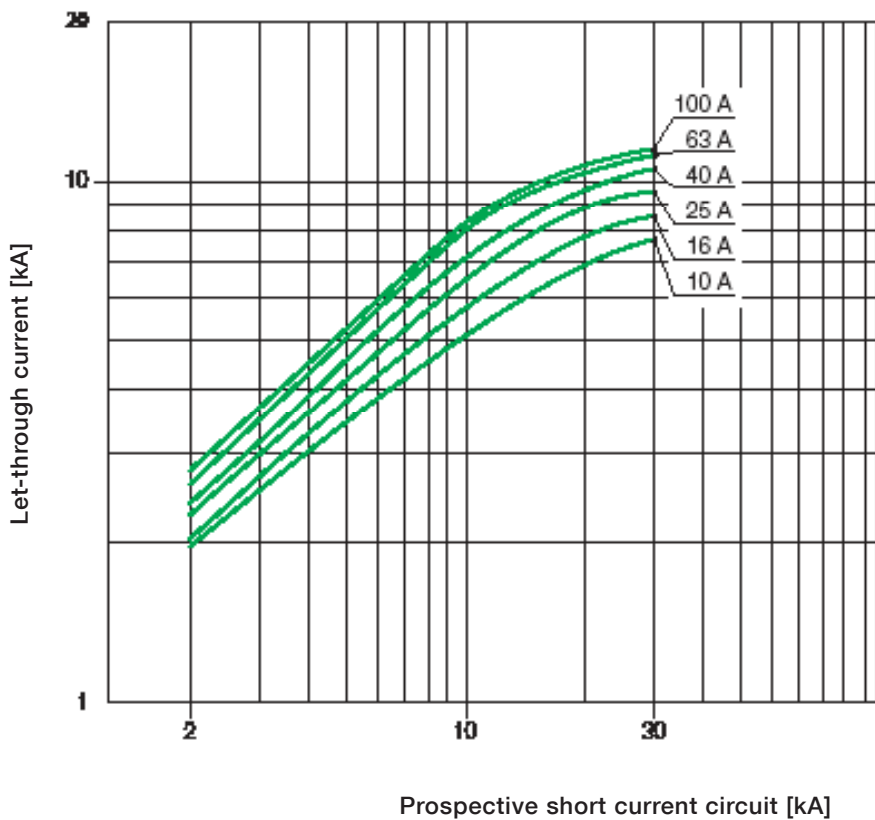
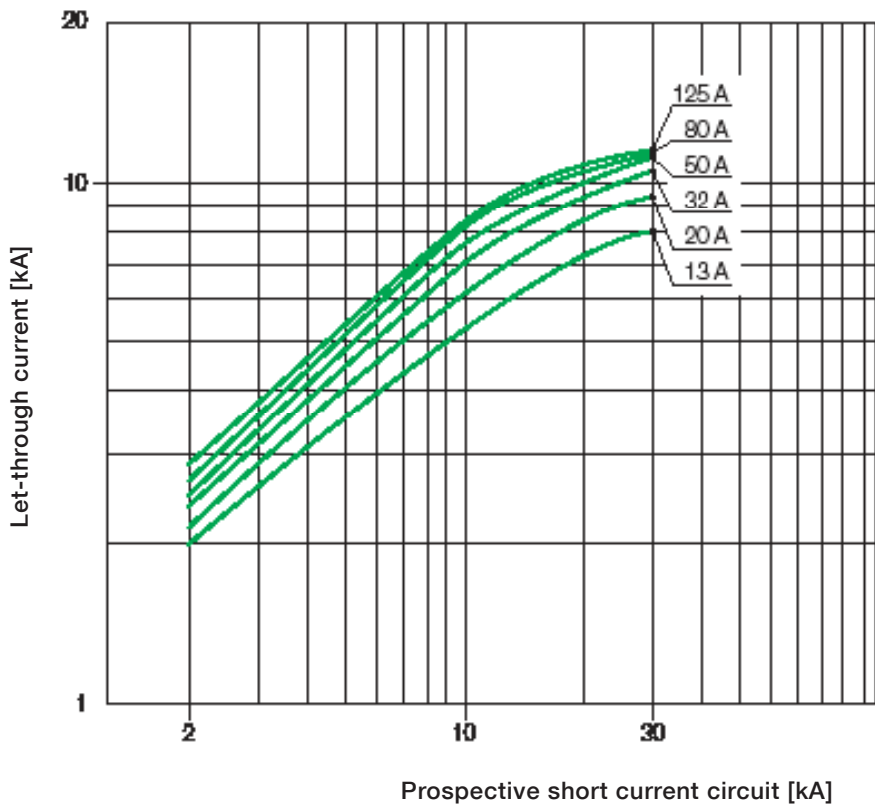

690 V Let-through current S800S-B, -C, -D , -K

3

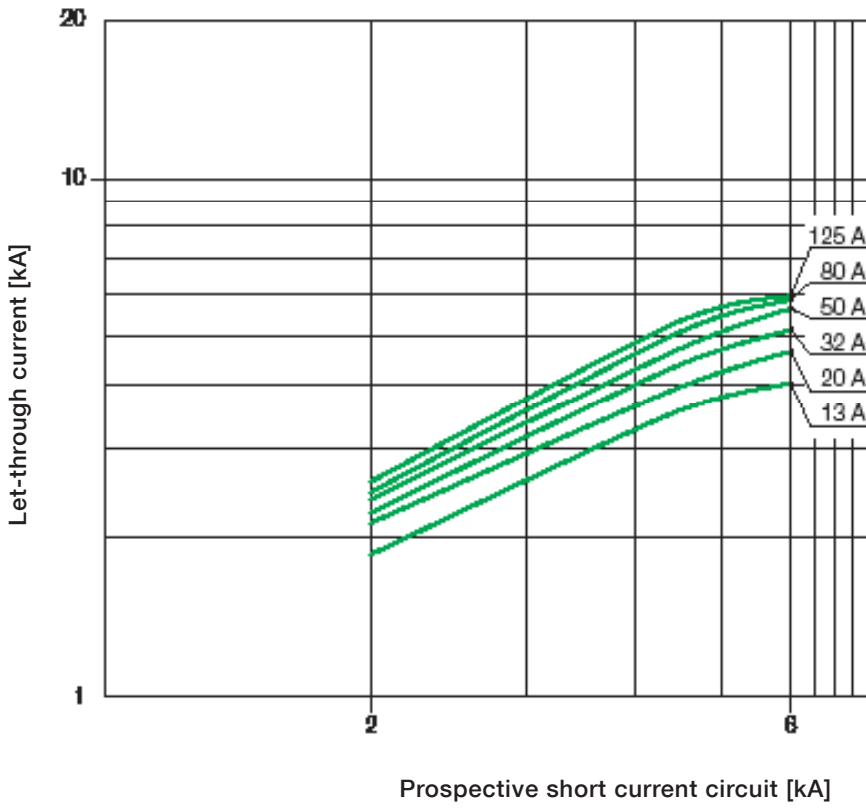

2000413296Z0001

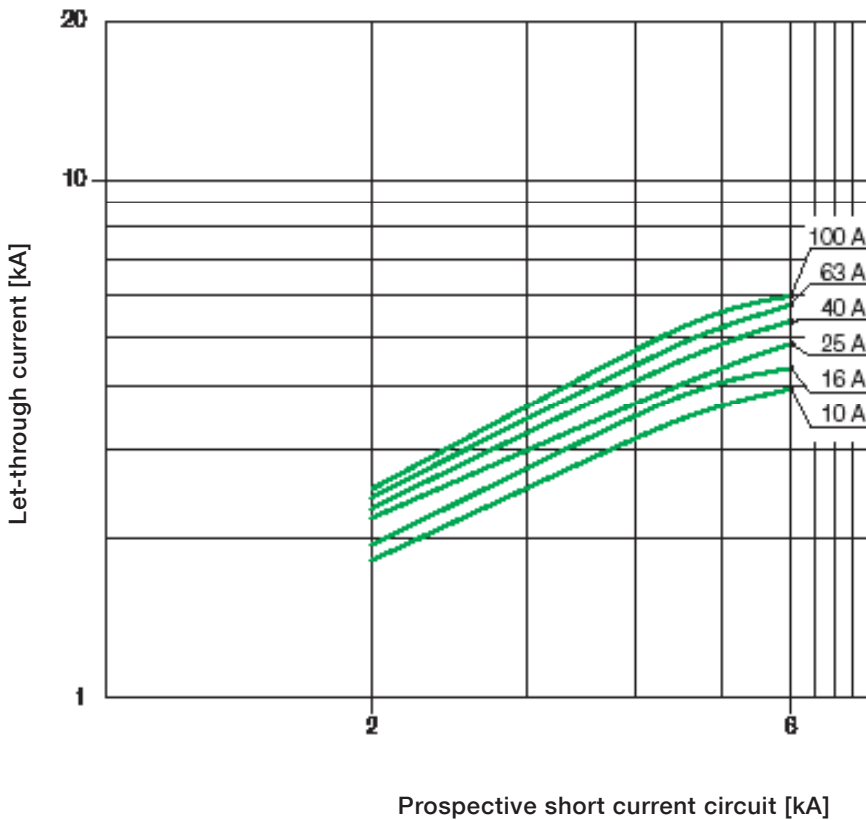

2000413297Z0001

230/400 V Let-through current S800N-B, -C, -D

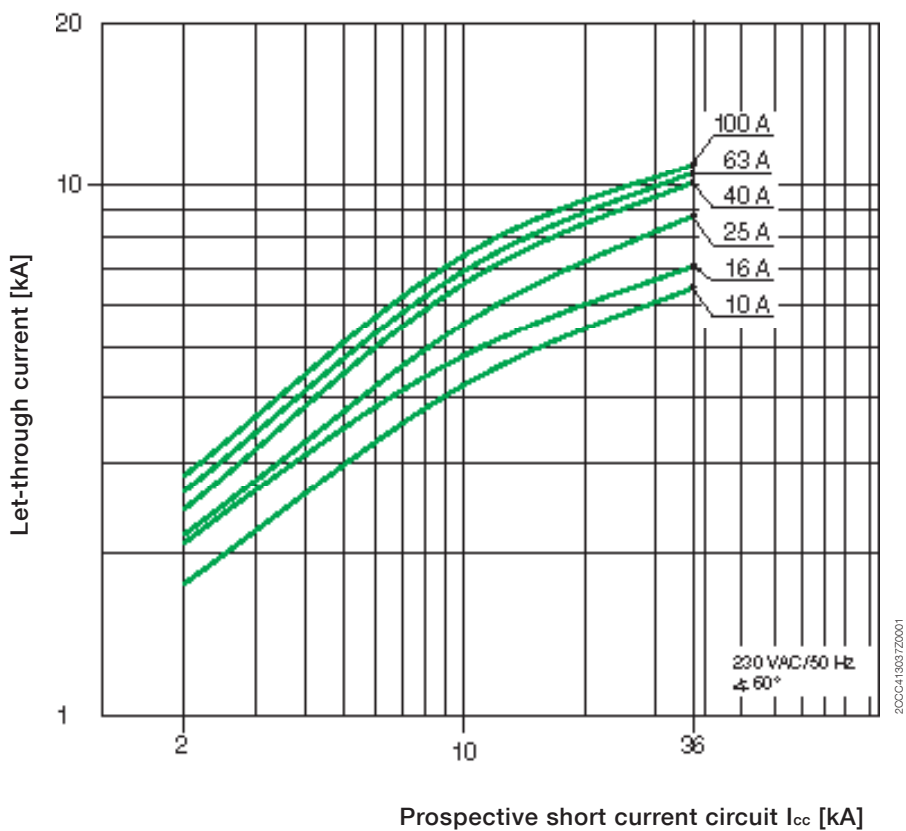
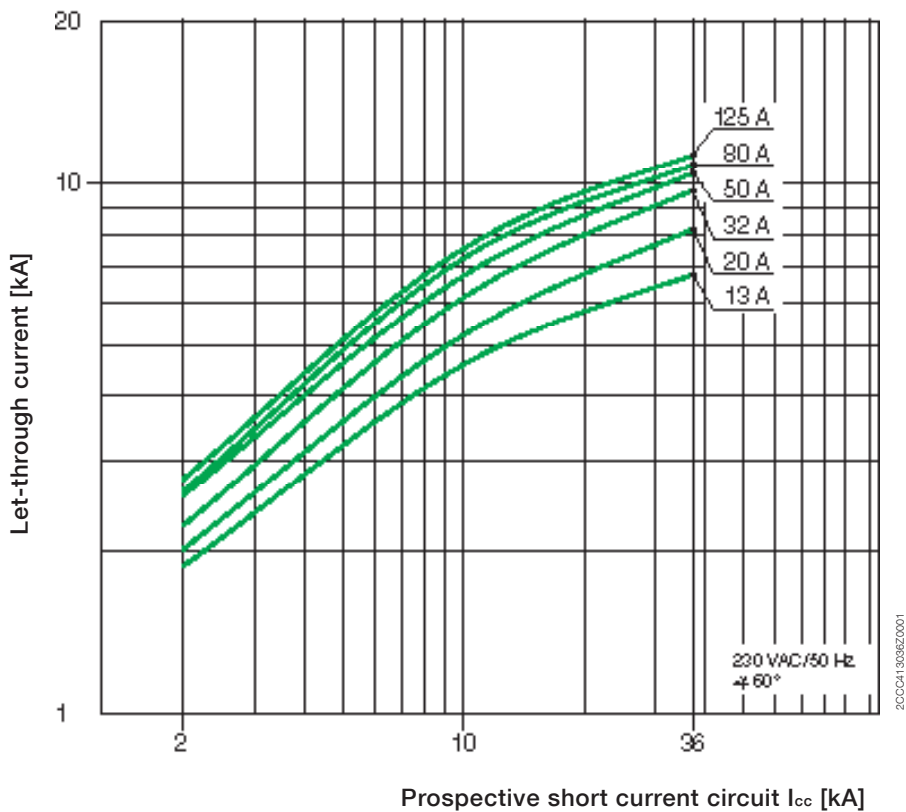

230/400 V Let-through current S800C-B, -C, -D, -K

3

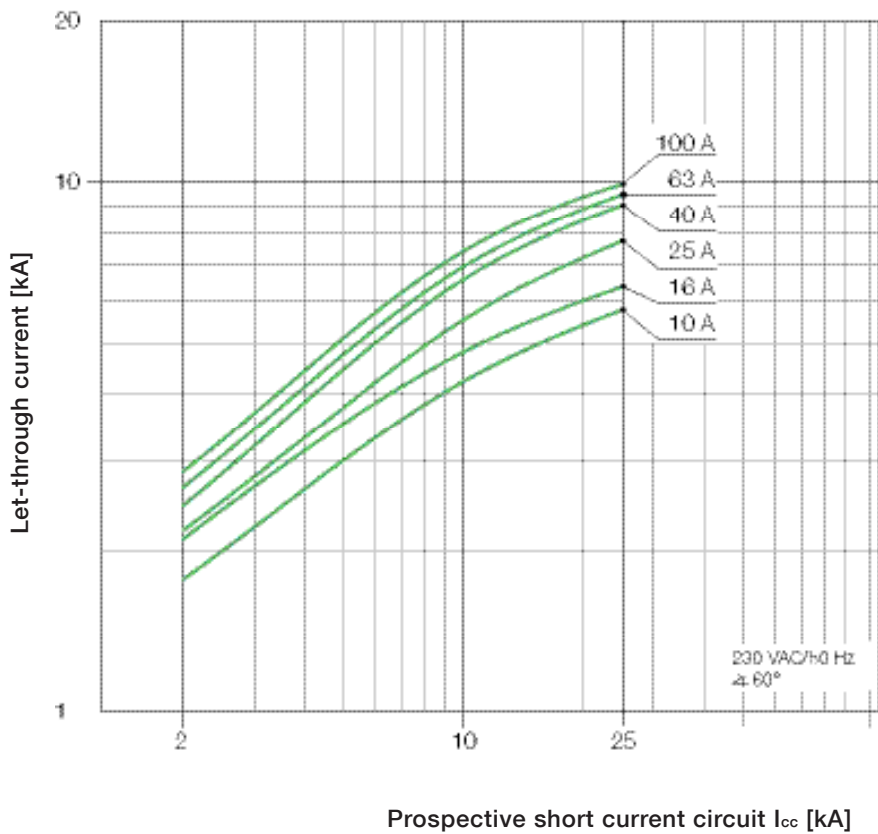
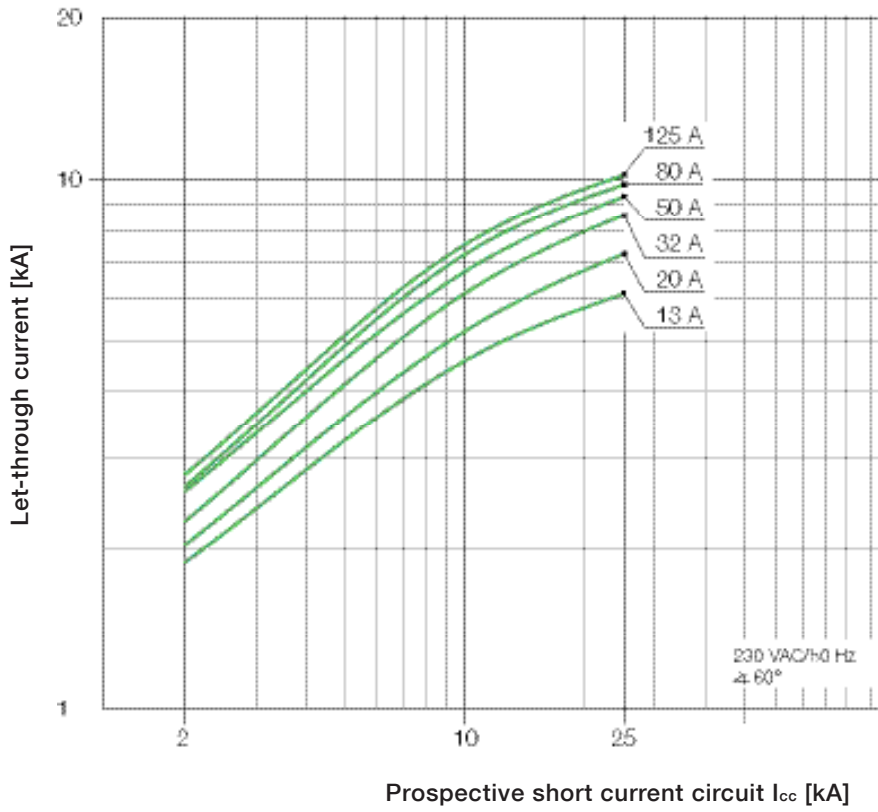

230/400 V Let-through current S800B-B, -C, -D, -K

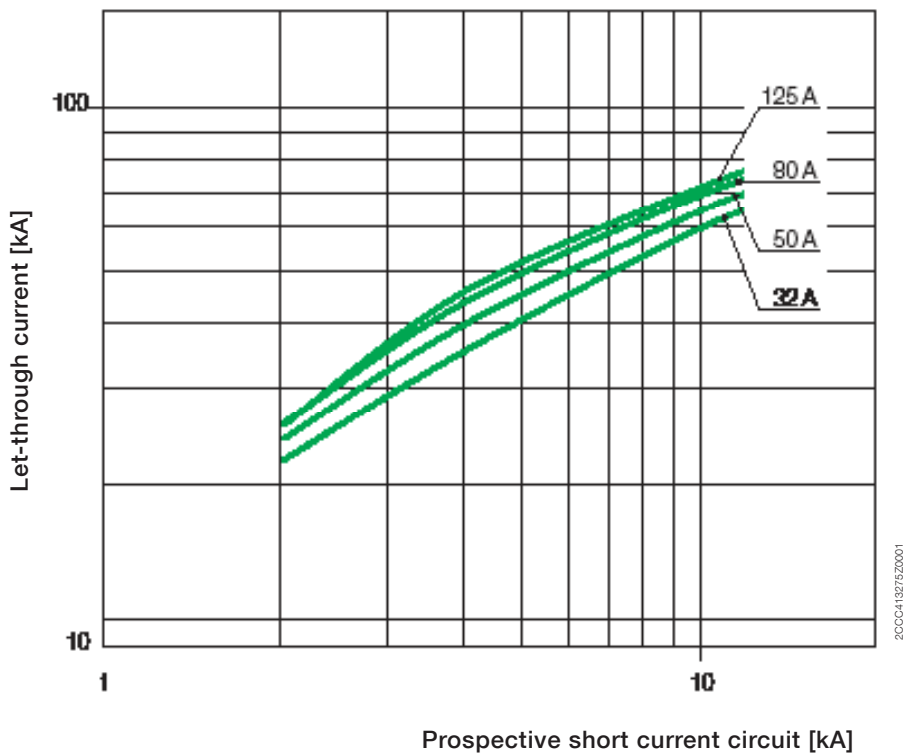
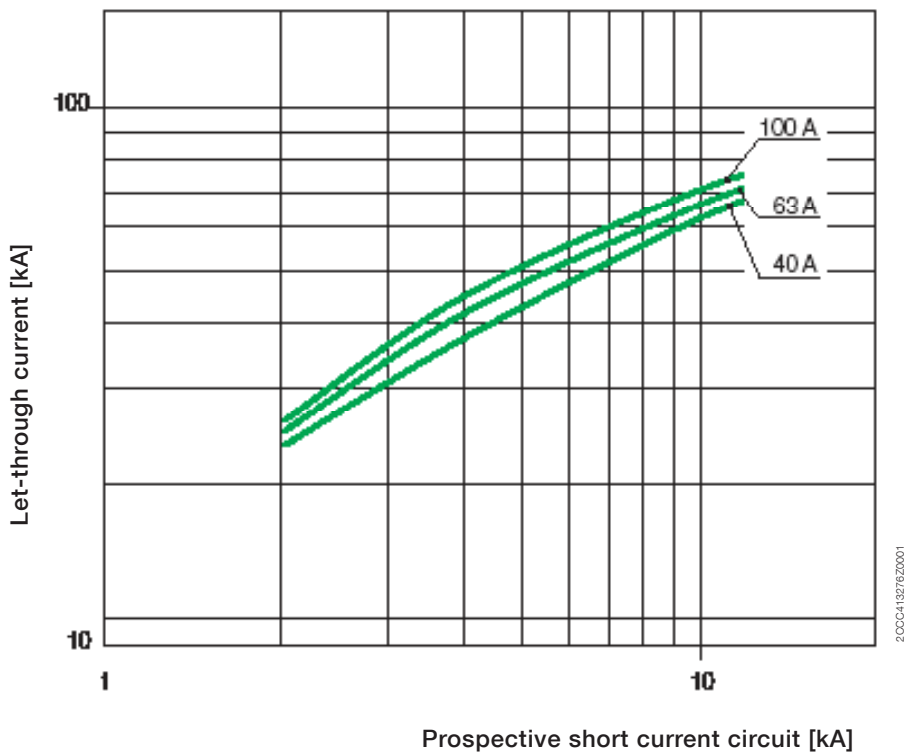

240 V Let-through current S800U-Z, -K

3

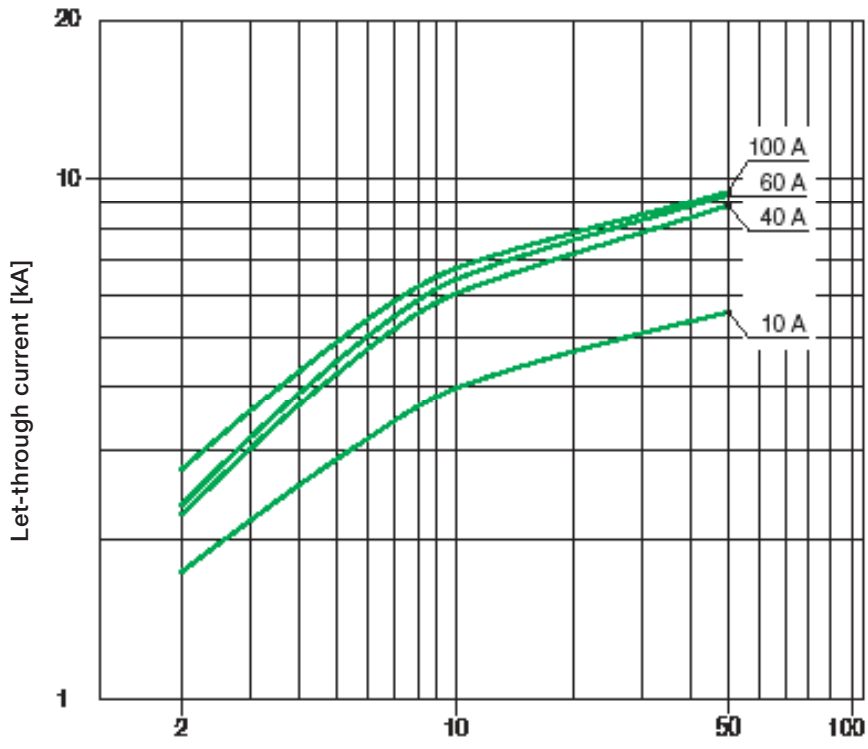

Prospective short current circuit I_{cc} [kA]

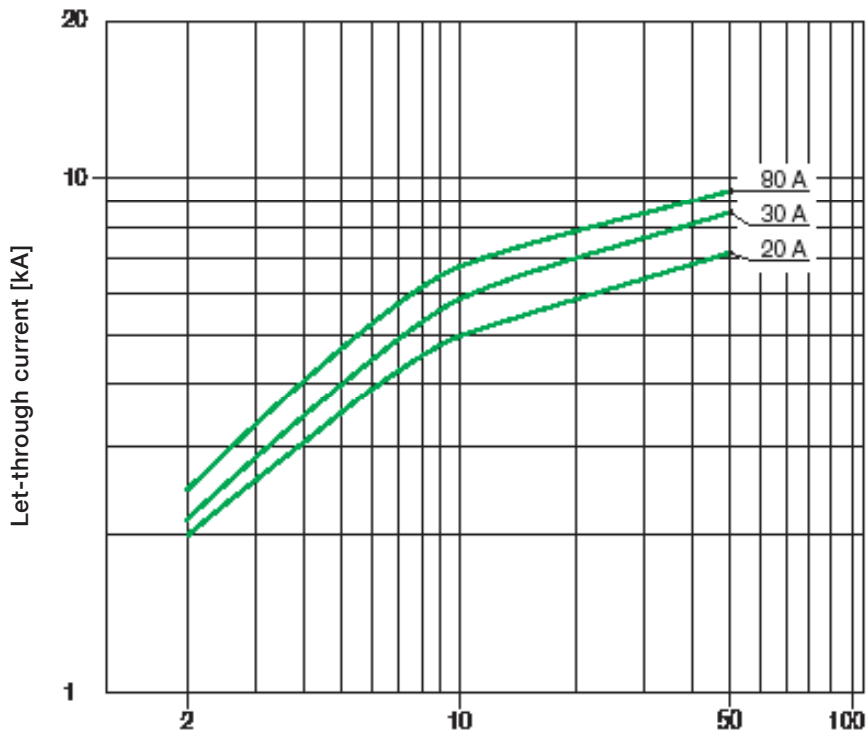

Prospective short current circuit I_{cc} [kA]

Table of content S800

Pole dimensions

S800	4/2
S800S-R	4/2

Dimensions of accessories

S800-AUX	4/3
S800-AUX/ALT	4/3
S800-NT	4/3
S800-RSU	4/5
S800W-RSU	4/5
S803S-SCL	4/5
S800S-SCL-SR	4/5
S803W-SCL-SR, S803HV-SCL-SR	4/6
S800-SOR	4/6
S800-UVR	4/6
S800-BB250	4/6
S800-BBPC120	4/6
S800-RD + S800-RHE	4/7
DDA802	4/7
DDA803	4/7
DDA804	4/7
DS802	4/8
DS803	4/8
DS804	4/8

Pole dimensions

High performance MCB

S800S
S800N
S800C
S800B
S800U
S800PV-SP
S800PV-SD

4

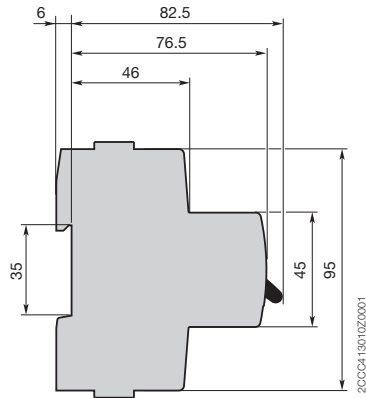
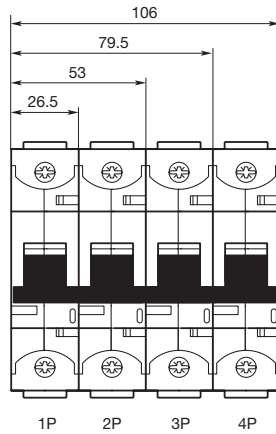

S800
with Ringlug
terminals

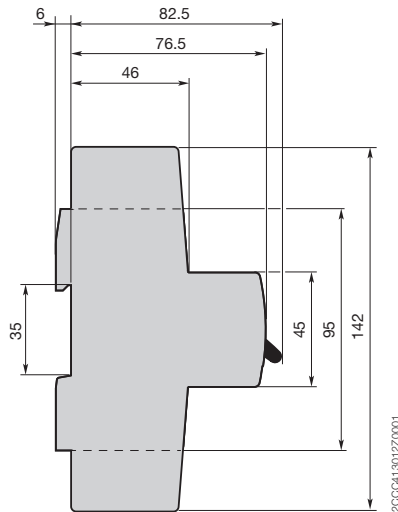
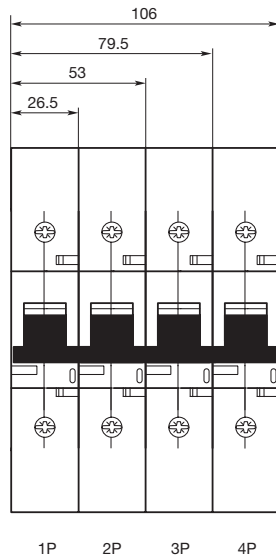

Dimensions of accessories

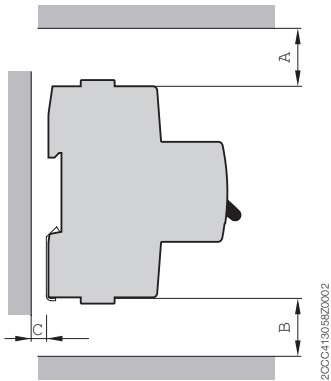

S800S, S800N, S800C

up to 254/440 VAC or 500 VDC

S800S-UC

up to 1000 VDC

S800S-SCL-SR

up to 400/690 VAC

Dimensions	isolated parts/surfaces	not isolated parts/surfaces
A	25	100
B	25	25
C	7	50

S800S, S800N, S800C, S800HV

from 254/440 VAC up to 400/690 VAC or 588/1000 VAC (S800HV)

S800B

up to 230/400 VAC or 300 VDC

S800PV-SP

up to 1500 VDC

Dimensions	isolated parts/surfaces	not isolated parts/surfaces
A	25	50
B	25	25
C	7	50

S800HV-SCLxx-SR

up to 588/1000 Vac

Dimensions	isolated parts/surfaces	not isolated parts/surfaces
A	25	150
B	25	25
C	7	50

Dimensions of accessories

S800-AUX

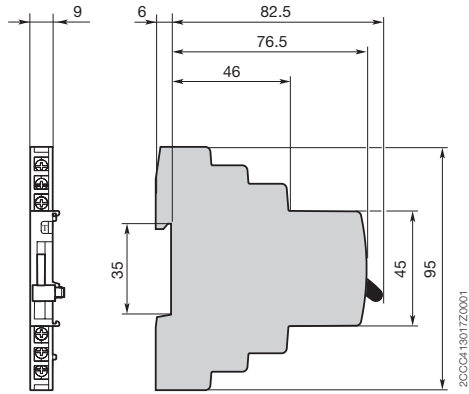

S800-AUX/ALT

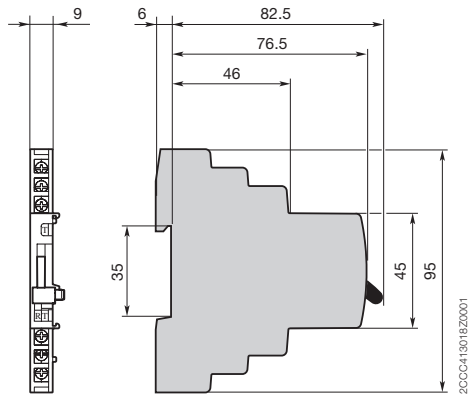

S800-NT

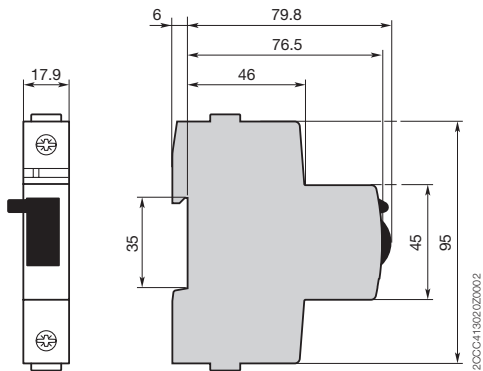

Pole dimensions

High performance MCB

S800-RSU-H

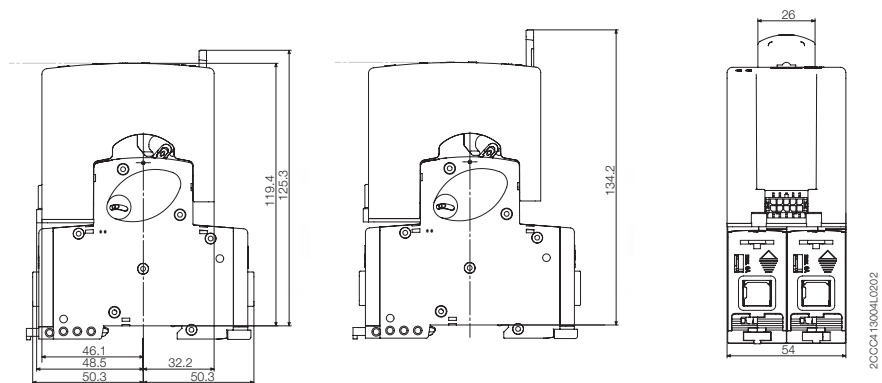

S800W-RSU

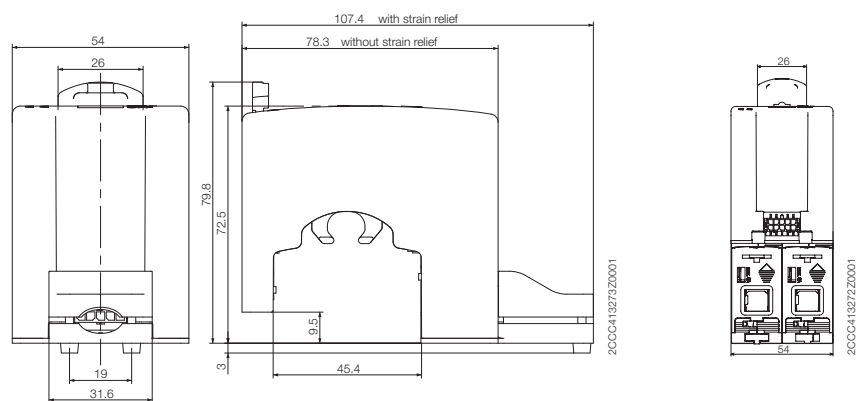

S803S-SCL

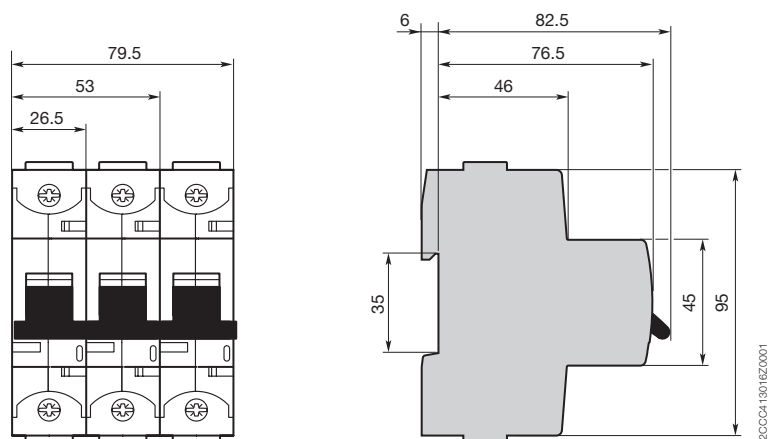

S800S-SCL-SR

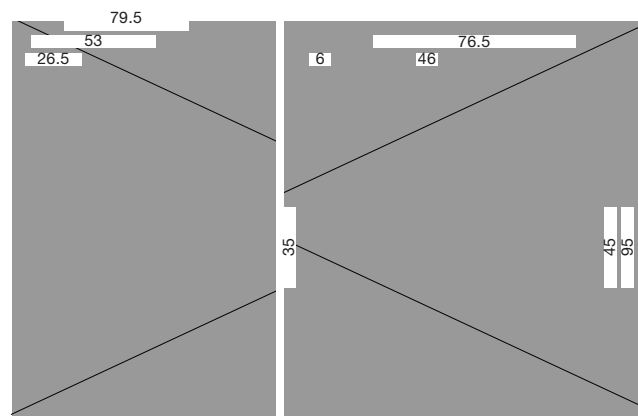

S803W-SCL-SR
S803HV-SCL-SR

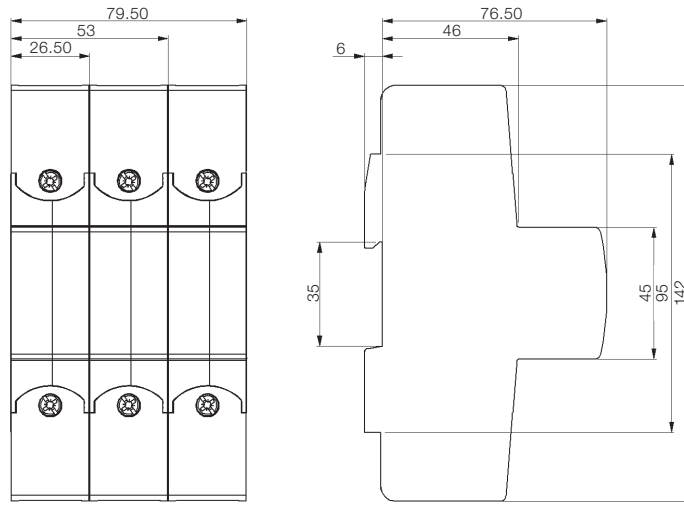

4

S800-SOR
S800-UVR

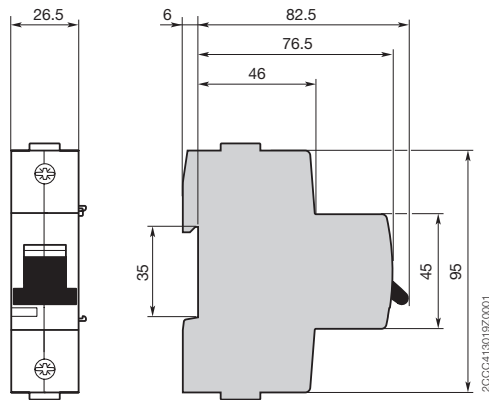

S800-BB250

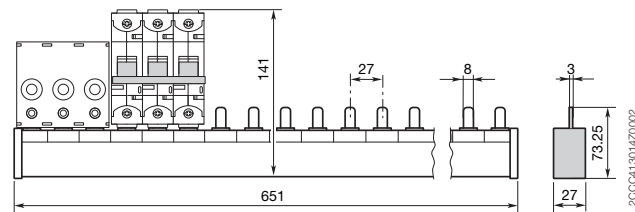

S800-BBPC120

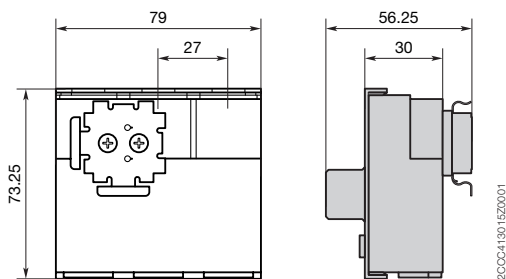

Pole dimensions

High performance MCB

S800-RD +
S800-RHE

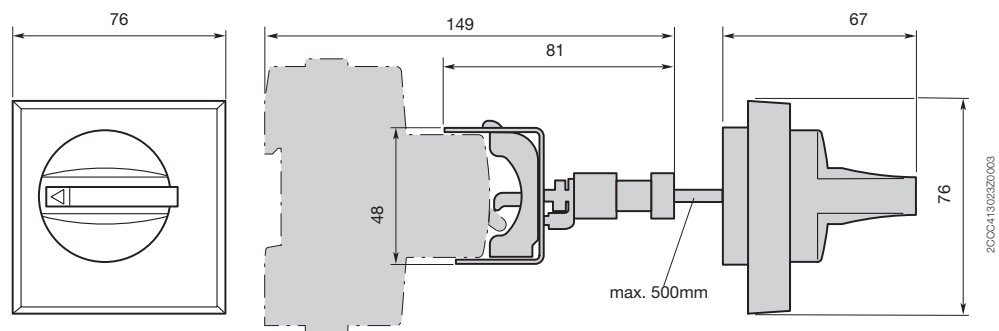

S802-LINK50
S802-LINK125

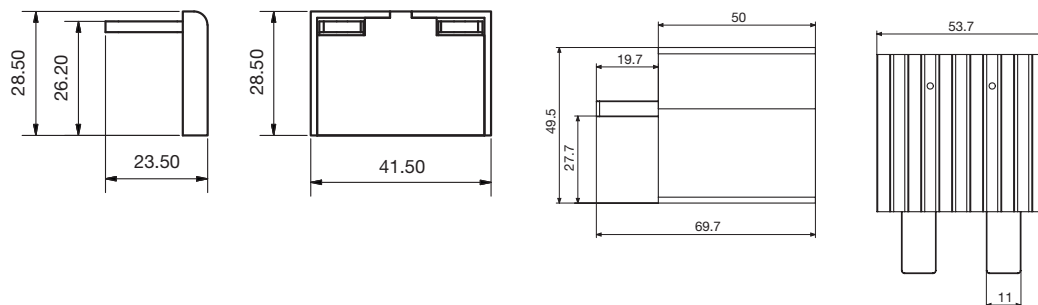

CMS-100S8

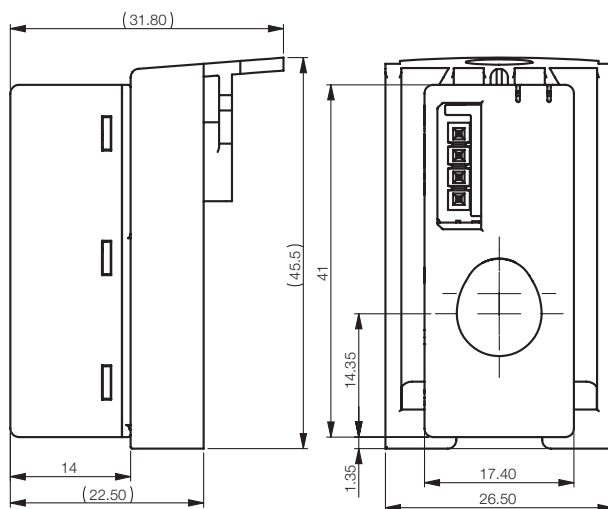

CMS-200S8

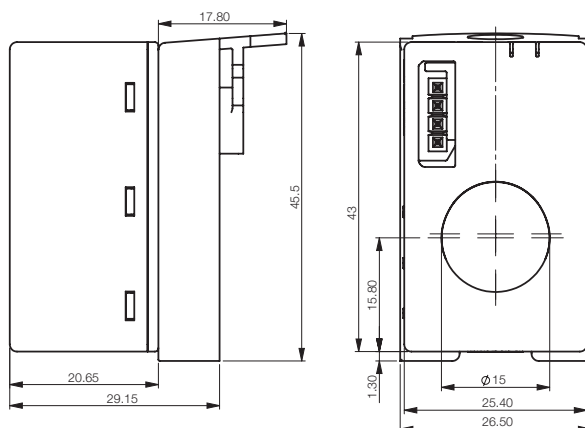

CMS-600

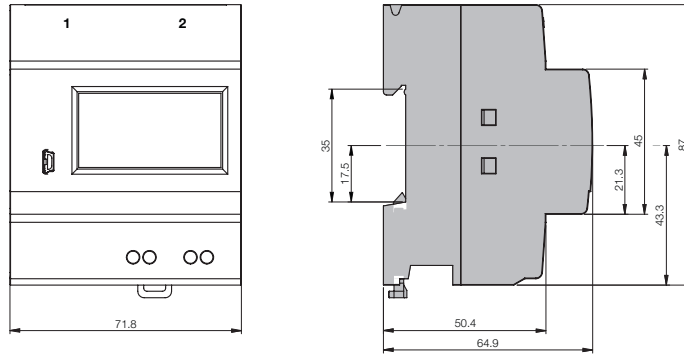

4

DDA802

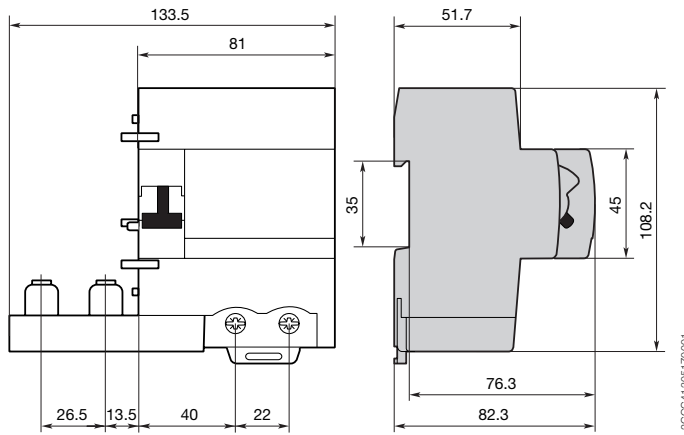

DDA803

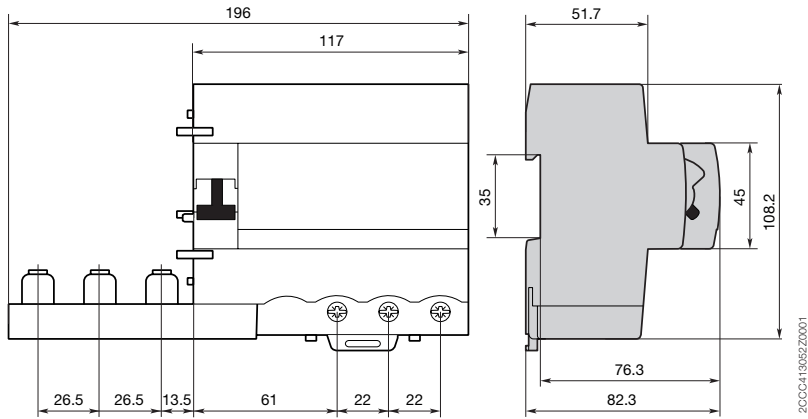

DDA804

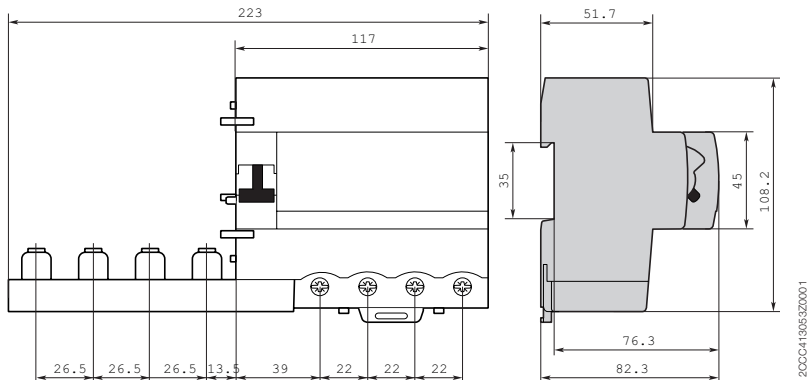

Pole dimensions

High performance MCB

DS802

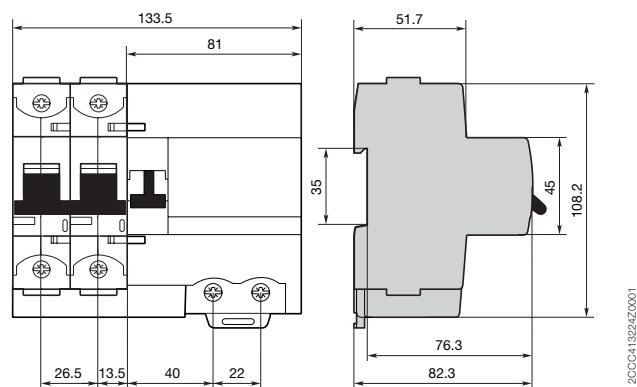

4

DS803

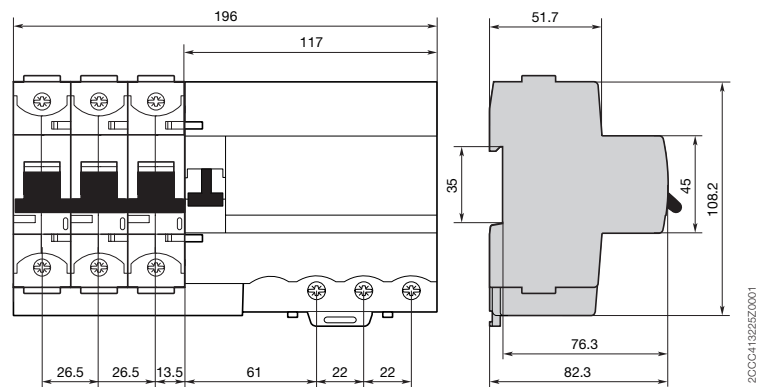

DS804

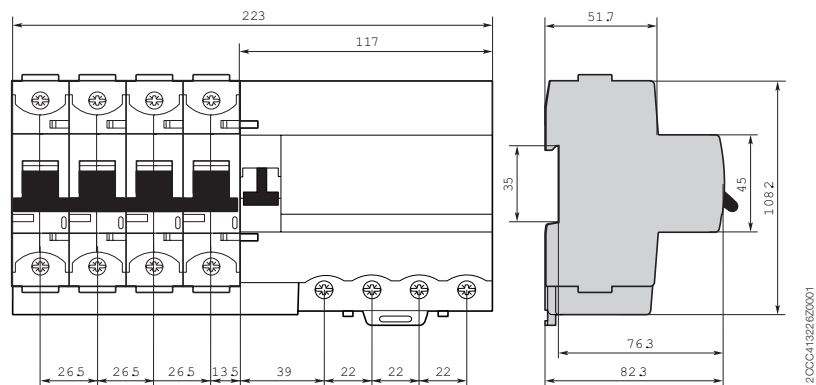











Table of content S800

Approvals and certifications

	Switzerland 	Germany 	China 	US/Canada 	Russia 	Norway Marine 	Germany Marine 	Great Britain Marine 	Italy Marine 	Russia Marine 
S800 Main devices										
S800S High performance MCB B	■	■	■		■	■	■	■	■	■
S800S High performance MCB C	■	■	■		■	■	■	■	■	■
S800S High performance MCB D	■	■	■		■	■	■	■	■	■
S800S High performance MCB K	■	■	■		■	■	■	■	■	■
S800U High performance MCB UL489				■						
S800S High performance MCB KM					■					
S800S High performance MCB UCB	■	■	■		■					■
S800S High performance MCB UCK	■	■	■		■					■
S800N High performance MCB B	■	■	■		■					
S800N High performance MCB C	■	■	■		■					
S800N High performance MCB D	■	■	■		■					
S800C High performance MCB B	■	■	■		■					
S800C High performance MCB C	■	■	■		■					
S800C High performance MCB D	■	■	■		■					
S800C High performance MCB K		■	■		■					
S800B High performance MCB B	■	■			■					
S800B High performance MCB C	■	■			■					
S800B High performance MCB D	■	■			■					
S800B High performance MCB K	■	■			■					
S800PV-SP High performance MCB		■	■							
S800PV-SD High performance MCB		■	■							
S802PV-M-H High performance MCB		■	■							
S800 accessories										
S800-AUX	■	■		■		■	■	■	■	■
S800-AUX/ALT	■	■	■	■		■	■	■	■	■
S800-NT	■		■							
S800W-RSU				■						
S803S-SCL						■	■		■	■
S803W-SCL-SR			□*	■		■	■			
S800-SCL-SR			□*			■				
S800-SOR				■						
S800-UVR				■						

■ devices are approved
□* exempted (not required to have CCC approval)

Table of content S500

S500-K	6/2
S500UC-K	6/4
S500HV	6/6
S500X-AG1499	6/7
S500X-AG0084	6/9
F500-K	6/10
Accessories S500	6/11

S500-K Characteristic K

I_{cu} up to 50 kA; adjustable high performance MCB



2CC0412002F0001



6

I_{cu} [kA]	Range of adjustment [A]	Order details Type Code	Order code	GTIN EAN 761227	Weight [kg]	Pack. unit
50	0.1–0.15	S501-K0,15	2CCF008856R0001	0303007	0.25	1
50	0.14–0.21	S501-K0,21	2CCF008857R0001	0303014	0.25	1
50	0.2–0.3	S501-K0,3	2CCF008858R0001	0303021	0.25	1
50	0.28–0.42	S501-K0,42	2CCF008859R0001	0303038	0.25	1
50	0.38–0.58	S501-K0,58	2CCF008860R0001	0303045	0.25	1
50	0.53–0.8	S501-K0,8	2CCF008861R0001	0303052	0.25	1
50	0.73–1.1	S501-K1,1	2CCF008862R0001	0303069	0.25	1
50	1–1.5	S501-K1,5	2CCF008863R0001	0303076	0.25	1
50	1.4–2.1	S501-K2,1	2CCF008864R0001	0303083	0.25	1
50	2–3	S501-K3	2CCF008865R0001	0303090	0.25	1
50	2.8–4.2	S501-K4,2	2CCF008866R0001	0303106	0.25	1
50	3.8–5.8	S501-K5,8	2CCF008867R0001	0303113	0.25	1
50	5.3–8	S501-K8	2CCF008868R0001	0303120	0.25	1
50	7.3–11	S501-K11	2CCF008869R0001	0303137	0.25	1
30	10–15	S501-K15	2CCF008870R0001	0303144	0.25	1
30	14–20	S501-K20	2CCF008871R0001	0303151	0.25	1
30	18–26	S501-K26	2CCF008872R0001	0303168	0.25	1
30	23–32	S501-K32	2CCF008873R0001	0303175	0.25	1
30	29–37	S501-K37	2CCF008874R0001	0303182	0.25	1
30	34–41	S501-K41	2CCF008875R0001	0303199	0.25	1
30	38–45	S501-K45	2CCF008888R0001	0303205	0.25	1



2CC0412007F0001



50	0.1–0.15	S502-K0,15	2CCF008894R0001	0303250	0.5	1
50	0.14–0.21	S502-K0,21	2CCF008895R0001	0303267	0.5	1
50	0.2–0.3	S502-K0,3	2CCF008896R0001	0303274	0.5	1
50	0.28–0.42	S502-K0,42	2CCF008897R0001	0303281	0.5	1
50	0.38–0.58	S502-K0,58	2CCF008898R0001	0303298	0.5	1
50	0.53–0.8	S502-K0,8	2CCF008899R0001	0303304	0.5	1
50	0.73–1.1	S502-K1,1	2CCF008900R0001	0303311	0.5	1
50	1–1.5	S502-K1,5	2CCF008901R0001	0303328	0.5	1
50	1.4–2.1	S502-K2,1	2CCF008902R0001	0303335	0.5	1
50	2–3	S502-K3	2CCF008903R0001	0303342	0.5	1
50	2.8–4.2	S502-K4,2	2CCF008904R0001	0303359	0.5	1
50	3.8–5.8	S502-K5,8	2CCF008905R0001	0303366	0.5	1
50	5.3–8	S502-K8	2CCF008906R0001	0303373	0.5	1
50	7.3–11	S502-K11	2CCF008907R0001	0303380	0.5	1
30	10–15	S502-K15	2CCF008908R0001	0303397	0.5	1
30	14–20	S502-K20	2CCF008909R0001	0303403	0.5	1
30	18–26	S502-K26	2CCF008910R0001	0303410	0.5	1
30	23–32	S502-K32	2CCF008911R0001	0303427	0.5	1
30	29–37	S502-K37	2CCF008912R0001	0303434	0.5	1
30	34–41	S502-K41	2CCF008913R0001	0303441	0.5	1
30	38–45	S502-K45	2CCF008926R0001	0303458	0.5	1

S500-K Characteristic K

I_{cu} up to 50 kA; adjustable high performance MCB



2CCCF008932R0001



I_{cu} [kA]	Range of adjustment [A]	Order details Type Code	Order code	GTIN EAN 761227	Weight [kg]	Pack. unit
50	0.1–0.15	S503-K0,15	2CCF008932R0001	0303502	0.71	1
50	0.14–0.21	S503-K0,21	2CCF008933R0001	0303519	0.71	1
50	0.2–0.3	S503-K0,3	2CCF008934R0001	0303526	0.71	1
50	0.28–0.42	S503-K0,42	2CCF008935R0001	0303533	0.71	1
50	0.38–0.58	S503-K0,58	2CCF008936R0001	0303540	0.71	1
50	0.53–0.8	S503-K0,8	2CCF008937R0001	0303557	0.71	1
50	0.73–1.1	S503-K1,1	2CCF008938R0001	0303564	0.71	1
50	1–1.5	S503-K1,5	2CCF008939R0001	0303571	0.71	1
50	1.4–2.1	S503-K2,1	2CCF008940R0001	0303588	0.71	1
50	2–3	S503-K3	2CCF008941R0001	0303595	0.71	1
50	2.8–4.2	S503-K4,2	2CCF008942R0001	0303601	0.71	1
50	3.8–5.8	S503-K5,8	2CCF008943R0001	0303618	0.71	1
50	5.3–8	S503-K8	2CCF008944R0001	0303625	0.71	1
50	7.3–11	S503-K11	2CCF008945R0001	0303632	0.71	1
30	10–15	S503-K15	2CCF008946R0001	0303649	0.71	1
30	14–20	S503-K20	2CCF008947R0001	0303656	0.71	1
30	18–26	S503-K26	2CCF008948R0001	0303663	0.71	1
30	23–32	S503-K32	2CCF008949R0001	0303670	0.71	1
30	29–37	S503-K37	2CCF008950R0001	0303687	0.71	1
30	34–41	S503-K41	2CCF008951R0001	0303694	0.71	1
30	38–45	S503-K45	2CCF008964R0001	0303700	0.71	1

4-pole breaker on request

S500UC-K Characteristic K*

$I_{cu} = 30 \text{ kA}$; adjustable high performance MCB



2CC0412001F0001



I_{cu} [kA]	Range of adjustment [A]	Order details Type Code	Order code	GTIN EAN 761227	Weight [kg]	Pack. unit
30	0.1–0.15	S501UC-K0,15	2CCF008988R0001	0302000	0.25	1
30	0.14–0.21	S501UC-K0,21	2CCF008991R0001	0302017	0.25	1
30	0.2–0.3	S501UC-K0,30	2CCF008994R0001	0302024	0.25	1
30	0.28–0.42	S501UC-K0,42	2CCF008997R0001	0302031	0.25	1
30	0.38–0.58	S501UC-K0,58	2CCF009000R0001	0302048	0.25	1
30	0.53–0.8	S501UC-K0,8	2CCF009003R0001	0302055	0.25	1
30	0.73–1.1	S501UC-K1,1	2CCF009006R0001	0302062	0.25	1
30	1–1.5	S501UC-K1,5	2CCF009009R0001	0302079	0.25	1
30	1.4–2.1	S501UC-K2,1	2CCF009012R0001	0302086	0.25	1
30	2–3	S501UC-K3	2CCF009015R0001	0302093	0.25	1
30	2.8–4.2	S501UC-K4,2	2CCF009018R0001	0302109	0.25	1
30	3.8–5.8	S501UC-K5,8	2CCF009021R0001	0302116	0.25	1
30	5.3–8	S501UC-K8	2CCF009024R0001	0302123	0.25	1
30	7.3–11	S501UC-K11	2CCF009027R0001	0302130	0.25	1
30	10–15	S501UC-K15	2CCF009030R0001	0302147	0.25	1
30	14–20	S501UC-K20	2CCF009033R0001	0302154	0.25	1
30	18–26	S501UC-K26	2CCF009036R0001	0302161	0.25	1
30	23–32	S501UC-K32	2CCF009039R0001	0302178	0.25	1
30	29–37	S501UC-K37	2CCF009042R0001	0302185	0.25	1
30	34–41	S501UC-K41	2CCF009045R0001	0302192	0.25	1
30	38–45	S501UC-K45	2CCF009048R0001	0302208	0.25	1



2CC0412006F0001



30	0.1–0.15	S502UC-K0,15	2CCF008989R0001	0302253	0.5	1
30	0.14–0.21	S502UC-K0,21	2CCF008992R0001	0302260	0.5	1
30	0.2–0.3	S502UC-K0,30	2CCF008995R0001	0302277	0.5	1
30	0.28–0.42	S502UC-K0,42	2CCF008998R0001	0302284	0.5	1
30	0.38–0.58	S502UC-K0,58	2CCF009001R0001	0302291	0.5	1
30	0.53–0.8	S502UC-K0,8	2CCF009004R0001	0302307	0.5	1
30	0.73–1.1	S502UC-K1,1	2CCF009007R0001	0302314	0.5	1
30	1–1.5	S502UC-K1,5	2CCF009010R0001	0302321	0.5	1
30	1.4–2.1	S502UC-K2,1	2CCF009013R0001	0302338	0.5	1
30	2–3	S502UC-K3	2CCF009016R0001	0302345	0.5	1
30	2.8–4.2	S502UC-K4,2	2CCF009019R0001	0302352	0.5	1
30	3.8–5.8	S502UC-K5,8	2CCF009022R0001	0302369	0.5	1
30	5.3–8	S502UC-K8	2CCF009025R0001	0302376	0.5	1
30	7.3–11	S502UC-K11	2CCF009028R0001	0302383	0.5	1
30	10–15	S502UC-K15	2CCF009031R0001	0302390	0.5	1
30	14–20	S502UC-K20	2CCF009034R0001	0302406	0.5	1
30	18–26	S502UC-K26	2CCF009037R0001	0302413	0.5	1
30	23–32	S502UC-K32	2CCF009040R0001	0302420	0.5	1
30	29–37	S502UC-K37	2CCF009043R0001	0302437	0.5	1
30	34–41	S502UC-K41	2CCF009046R0001	0302444	0.5	1
30	38–45	S502UC-K45	2CCF009049R0001	0302451	0.5	1

* for DC applications

S500UC-K Characteristic K*

$I_{cu} = 30 \text{ kA}$; adjustable high performance MCB



2CCF412011R0001



I_{cu} [kA]	Range of adjustment [A]	Order details Type Code	Order code	GTIN EAN 761227	Weight [kg]	Pack. unit
30	0.1–0.15	S503UC-K0,15	2CCF008990R0001	0302505	0.71	1
30	0.14–0.21	S503UC-K0,21	2CCF008993R0001	0302512	0.71	1
30	0.2–0.3	S503UC-K0,30	2CCF008996R0001	0302529	0.71	1
30	0.28–0.42	S503UC-K0,42	2CCF008999R0001	0302536	0.71	1
30	0.38–0.58	S503UC-K0,58	2CCF009002R0001	0302543	0.71	1
30	0.53–0.8	S503UC-K0,8	2CCF009005R0001	0302550	0.71	1
30	0.73–1.1	S503UC-K1,1	2CCF009008R0001	0302567	0.71	1
30	1–1.5	S503UC-K1,5	2CCF009011R0001	0302574	0.71	1
30	1.4–2.1	S503UC-K2,1	2CCF009014R0001	0302581	0.71	1
30	2–3	S503UC-K3	2CCF009017R0001	0302598	0.71	1
30	2.8–4.2	S503UC-K4,2	2CCF009020R0001	0302604	0.71	1
30	3.8–5.8	S503UC-K5,8	2CCF009023R0001	0302611	0.71	1
30	5.3–8	S503UC-K8	2CCF009026R0001	0302628	0.71	1
30	7.3–11	S503UC-K11	2CCF009029R0001	0302635	0.71	1
30	10–15	S503UC-K15	2CCF009032R0001	0302642	0.71	1
30	14–20	S503UC-K20	2CCF009035R0001	0302659	0.71	1
30	18–26	S503UC-K26	2CCF009038R0001	0302666	0.71	1
30	23–32	S503UC-K32	2CCF009041R0001	0302673	0.71	1
30	29–37	S503UC-K37	2CCF009044R0001	0302680	0.71	1
30	34–41	S503UC-K41	2CCF009047R0001	0302697	0.71	1
30	38–45	S503UC-K45	2CCF009050R0001	0302703	0.71	1



2CCF412011R0001



30	0.1–0.15	S504UC-K0,15	2CCF011771R0001	0302758	0.92	1
30	0.14–0.21	S504UC-K0,21	2CCF011772R0001	0302765	0.92	1
30	0.2–0.3	S504UC-K0,3	2CCF011576R0001	0302772	0.92	1
30	0.28–0.42	S504UC-K0,42	2CCF011773R0001	0302789	0.92	1
30	0.38–0.58	S504UC-K0,58	2CCF011774R0001	0302796	0.92	1
30	0.53–0.8	S504UC-K0,8	2CCF011775R0001	0302802	0.92	1
30	0.73–1.1	S504UC-K1,1	2CCF011776R0001	0302819	0.92	1
30	1–1.5	S504UC-K1,5	2CCF011777R0001	0302826	0.92	1
30	1.4–2.1	S504UC-K2,1	2CCF011778R0001	0302833	0.92	1
30	2–3	S504UC-K3	2CCF011779R0001	0302840	0.92	1
30	2.8–4.2	S504UC-K4,2	2CCF011780R0001	0302857	0.92	1
30	3.8–5.8	S504UC-K5,8	2CCF011781R0001	0302864	0.92	1
30	5.3–8	S504UC-K8	2CCF011782R0001	0302871	0.92	1
30	7.3–11	S504UC-K11	2CCF011509R0001	0302888	0.92	1
30	10–15	S504UC-K15	2CCF011783R0001	0302895	0.92	1
30	14–20	S504UC-K20	2CCF011784R0001	0302901	0.92	1
30	18–26	S504UC-K26	2CCF011785R0001	0302918	0.92	1
30	23–32	S504UC-K32	2CCF011786R0001	0302925	0.92	1
30	29–37	S504UC-K37	2CCF011787R0001	0302932	0.92	1
30	34–41	S504UC-K41	2CCF011788R0001	0302949	0.92	1
30	38–45	S504UC-K45	2CCF011789R0001	0302956	0.92	1

* for DC applications

S500HV-K Characteristic K

$I_{cu} = 1,5 \text{ kA}$; for applications up to 1000 VAC



2CCCF012009R0001



I_{cu} [kA]	Range of adjustment [A]	Order details Type Code	Order code	GTIN EAN 761227	Weight [kg]	Pack. unit
1.5	1	S501HV-K1 580V	2CCCF017747R0001	0403454	0.25	1
1.5	3	S501HV-K3 580V	2CCCF015787R0001	0424160	0.25	1
1.5	4	S501HV-K4 580V	2CCCF015790R0001	0424184	0.25	1
1.5	6	S501HV-K6 580V	2CCCF015793R0001	0424214	0.25	1
1.5	8	S501HV-K8 580V	2CCCF015796R0001	0424245	0.25	1
1.5	10	S501HV-K10 580V	2CCCF015799R0001	0424276	0.25	1
1.5	13	S501HV-K13 580V	2CCCF015802R0001	0424306	0.25	1
1.5	16	S501HV-K16 580V	2CCCF015805R0001	0424337	0.25	1
1.5	20	S501HV-K20 580V	2CCCF015808R0001	0424368	0.25	1
1.5	25	S501HV-K25 580V	2CCCF015811R0001	0424399	0.25	1
1.5	32	S501HV-K32 580V	2CCCF015814R0001	0424429	0.25	1
1.5	40	S501HV-K40 580V	2CCCF015817R0001	0424450	0.25	1
1.5	45	S501HV-K45 580V	2CCCF015820R0001	0424481	0.25	1



2CCCF012008R0001



1.5	1	S502HV-K1 1000V	2CCCF017961R0001	1407810	0.50	1
1.5	3	S502HV-K3 1000V	2CCCF015788R0001	0424177	0.50	1
1.5	4	S502HV-K4 1000V	2CCCF015791R0001	0424191	0.50	1
1.5	6	S502HV-K6 1000V	2CCCF015794R0001	0424221	0.50	1
1.5	8	S502HV-K8 1000V	2CCCF015797R0001	0424252	0.50	1
1.5	10	S502HV-K10 1000V	2CCCF015800R0001	0424283	0.50	1
1.5	13	S502HV-K13 1000V	2CCCF015803R0001	0424313	0.50	1
1.5	16	S502HV-K16 1000V	2CCCF015806R0001	0424344	0.50	1
1.5	20	S502HV-K20 1000V	2CCCF015809R0001	0424375	0.50	1
1.5	25	S502HV-K25 1000V	2CCCF015812R0001	0424405	0.50	1
1.5	32	S502HV-K32 1000V	2CCCF015815R0001	0424436	0.50	1
1.5	40	S502HV-K40 1000V	2CCCF015818R0001	0424467	0.50	1
1.5	45	S502HV-K45 1000V	2CCCF015821R0001	0424498	0.50	1



2CCCF012014R0001



1.5	1	S503HV-K1 1000V	2CCCF017748R0001	0403461	0.71	1
1.5	3	S503HV-K3 1000V	2CCCF015827R0001	0500499	0.71	1
1.5	4	S503HV-K4 1000V	2CCCF015792R0001	0424207	0.71	1
1.5	6	S503HV-K6 1000V	2CCCF015795R0001	0424238	0.71	1
1.5	8	S503HV-K8 1000V	2CCCF015798R0001	0424269	0.71	1
1.5	10	S503HV-K10 1000V	2CCCF015801R0001	0424290	0.71	1
1.5	13	S503HV-K13 1000V	2CCCF015804R0001	0424320	0.71	1
1.5	16	S503HV-K16 1000V	2CCCF015807R0001	0424351	0.71	1
1.5	20	S503HV-K20 1000V	2CCCF015810R0001	0424382	0.71	1
1.5	25	S503HV-K25 1000V	2CCCF015813R0001	0424412	0.71	1
1.5	32	S503HV-K32 1000V	2CCCF015816R0001	0424443	0.71	1
1.5	40	S503HV-K40 1000V	2CCCF015819R0001	0424474	0.71	1
1.5	45	S503HV-K45 1000V	2CCCF015822R0001	0424504	0.71	1

S500X-AG1499

High magnetic release 16 ... 24 x I_n



2CCF012005R0001



I _{cu} [kA]	Range of adjustment [A]	Order details Type Code	Order code	GTIN EAN 761227	Weight [kg]	Pack. unit
50	0.1–0.15	S501X-AG1499-0,15	2CCF008773R0001	0577996	0.25	1
50	0.14–0.21	S501X-AG1499-0,21	2CCF008774R0001	0577989	0.25	1
50	0.2–0.3	S501X-AG1499-0,30	2CCF008775R0001	0577972	0.25	1
50	0.28–0.42	S501X-AG1499-0,42	2CCF008776R0001	0577965	0.25	1
50	0.38–0.58	S501X-AG1499-0,58	2CCF008777R0001	0577958	0.25	1
50	0.53–0.8	S501X-AG1499-0,8	2CCF008778R0001	0577941	0.25	1
50	0.73–1.1	S501X-AG1499-1,1	2CCF008779R0001	0577934	0.25	1
50	1–1.5	S501X-AG1499-1,50	2CCF008780R0001	0577927	0.25	1
50	1.4–2.1	S501X-AG1499-2,1	2CCF008781R0001	0577880	0.25	1
50	2–3	S501X-AG1499-3	2CCF008782R0001	0577859	0.25	1
50	2.8–4.2	S501X-AG1499-4,2	2CCF008783R0001	0577828	0.25	1
50	3.8–5.8	S501X-AG1499-5,8	2CCF008784R0001	0577798	0.25	1
50	5.3–8	S501X-AG1499-8	2CCF008785R0001	0577774	0.25	1
50	7.3–11	S501X-AG1499-11	2CCF008786R0001	0577910	0.25	1
30	10–15	S501X-AG1499-15	2CCF008787R0001	0577897	0.25	1
30	14–20	S501X-AG1499-20	2CCF008788R0001	0577873	0.25	1
30	18–26	S501X-AG1499-26	2CCF008789R0001	0577866	0.25	1
30	23–32	S501X-AG1499-32	2CCF008790R0001	0577842	0.25	1
30	29–37	S501X-AG1499-37	2CCF008791R0001	0577835	0.25	1
30	34–41	S501X-AG1499-41	2CCF008792R0001	0577811	0.25	1
30	38–45	S501X-AG1499-45	2CCF008793R0001	0577804	0.25	1



2CCF012010R0001



50	0.1–0.15	S502X-AG1499-0,15	2CCF008794R0001	0576722	0.5	1
50	0.14–0.21	S502X-AG1499-0,21	2CCF008795R0001	0576715	0.5	1
50	0.2–0.3	S502X-AG1499-0,30	2CCF008796R0001	0576708	0.5	1
50	0.28–0.42	S502X-AG1499-0,42	2CCF008797R0001	0576692	0.5	1
50	0.38–0.58	S502X-AG1499-0,58	2CCF008798R0001	0576685	0.5	1
50	0.53–0.8	S502X-AG1499-0,8	2CCF008799R0001	0576678	0.5	1
50	0.73–1.1	S502X-AG1499-1,1	2CCF008800R0001	0576661	0.5	1
50	1–1.5	S502X-AG1499-1,5	2CCF008801R0001	0576654	0.5	1
50	1.4–2.1	S502X-AG1499-2,1	2CCF008802R0001	0576623	0.5	1
50	2–3	S502X-AG1499-3	2CCF008803R0001	0576593	0.5	1
50	2.8–4.2	S502X-AG1499-4,2	2CCF008804R0001	0576562	0.5	1
50	3.8–5.8	S502X-AG1499-5,8	2CCF008805R0001	0576531	0.5	1
50	5.3–8	S502X-AG1499-8	2CCF008806R0001	0576524	0.5	1
50	7.3–11	S502X-AG1499-11	2CCF008807R0001	0576647	0.5	1
30	10–15	S502X-AG1499-15	2CCF008808R0001	0576630	0.5	1
30	14–20	S502X-AG1499-20	2CCF008809R0001	0576616	0.5	1
30	18–26	S502X-AG1499-26	2CCF008810R0001	0576609	0.5	1
30	23–32	S502X-AG1499-32	2CCF008811R0001	0576586	0.5	1
30	29–37	S502X-AG1499-37	2CCF008812R0001	0576579	0.5	1
30	34–41	S502X-AG1499-41	2CCF008813R0001	0576555	0.5	1
30	38–45	S502X-AG1499-45	2CCF008814R0001	0576548	0.5	1

S500X-AG1499

High magnetic release 16 ... 24 x I_n



2CCCF00821R0001



I _{cu} [kA]	Range of adjustment [A]	Order details Type Code	Order code	GTIN EAN 761227	Weight [kg]	Pack. unit
50	0.1–0.15	S503X-AG1499-0,15	2CCF008821R0001	0572311	0.71	1
50	0.14–0.21	S503X-AG1499-0,21	2CCF008822R0001	0572304	0.71	1
50	0.2–0.3	S503X-AG1499-0,30	2CCF008823R0001	0572298	0.71	1
50	0.28–0.42	S503X-AG1499-0,42	2CCF008824R0001	0572281	0.71	1
50	0.38–0.58	S503X-AG1499-0,58	2CCF008825R0001	0572274	0.71	1
50	0.53–0.8	S503X-AG1499-0,8	2CCF008826R0001	0572267	0.71	1
50	0.73–1.1	S503X-AG1499-1,1	2CCF008827R0001	0572250	0.71	1
50	1–1.5	S503X-AG1499-1,5	2CCF008828R0001	0572243	0.71	1
50	1.4–2.1	S503X-AG1499-2,1	2CCF008829R0001	0572205	0.71	1
50	2–3	S503X-AG1499-3	2CCF008830R0001	0572175	0.71	1
50	2.8–4.2	S503X-AG1499-4,2	2CCF008831R0001	0572144	0.71	1
50	3.8–5.8	S503X-AG1499-5,8	2CCF008832R0001	0572113	0.71	1
50	5.3–8	S503X-AG1499-8	2CCF008833R0001	0572106	0.71	1
50	7.3–11	S503X-AG1499-11	2CCF008834R0001	0572236	0.71	1
30	10–15	S503X-AG1499-15	2CCF008835R0001	0572212	0.71	1
30	14–20	S503X-AG1499-20	2CCF008836R0001	0572199	0.71	1
30	18–26	S503X-AG1499-26	2CCF008837R0001	0572182	0.71	1
30	23–32	S503X-AG1499-32	2CCF008838R0001	0572168	0.71	1
30	29–37	S503X-AG1499-37	2CCF008839R0001	0572151	0.71	1
30	34–41	S503X-AG1499-41	2CCF008840R0001	0572137	0.71	1
30	38–45	S503X-AG1499-45	2CCF008841R0001	0572120	0.71	1

S503X-AG0084

Magnetic release only (MO)



2CCCF01202RF0001



I_{cu} [kA]	Rated current [A]	Order details Type Code	Order code	GTIN EAN 761227	Weight [kg]	Pack. unit
50	0.8	S503X-AG0084-0.8	2CCF011613R0001	0500550	0.71	1
50	1.6	S503X-AG0084-1.6	2CCF014894R0001	0303908	0.71	1
50	2.5	S503X-AG0084-2.5	2CCF014895R0001	0303915	0.71	1
50	4	S503X-AG0084-4	2CCF014896R0001	0303922	0.71	1
50	6	S503X-AG0084-6	2CCF014897R0001	0303939	0.71	1
50	9	S503X-AG0084-9	2CCF014898R0001	0303946	0.71	1
50	15	S503X-AG0084-15	2CCF011532R0001	0500598	0.71	1
50	20	S503X-AG0084-20	2CCF011614R0001	0303953	0.71	1
50	25	S503X-AG0084-25	2CCF013067R0001	0500628	0.71	1
50	32	S503X-AG0084-32	2CCF011535R0001	0303960	0.71	1
50	40	S503X-AG0084-40	2CCF013061R0001	0303991	0.71	1
50	45	S503X-AG0084-45	2CCF013068R0001	0500697	0.71	1
50	52	S503X-AG0084-52	2CCF014963R0001	0303977	0.71	1
50	63	S503X-AG0084-63	2CCF014541R0001	0303984	0.71	1

F500-K

Residual current protection with motor protection



2CCCF014995R0001

I_{cu}	$I_{\Delta n}$	U_e	Range of adjustment	Order details	Order code	GTIN EAN	Weight	Pack.
[kA]	[mA]	[V]	[A]	Type Code		761227	[kg]	unit
50	30	400	0.53–0.8	F503-K0,8/0,03	2CCF014995R0001	0501496	1.07	1
50	30	400	0.73–1.1	F503-K1,1/0,03	2CCF014713R0001	0503087	1.07	1
50	30	400	1–1.5	F503-K1,5/0,03	2CCF014714R0001	0304691	1.07	1
50	30	400	1.4–2.1	F503-K2,1/0,03	2CCF014715R0001	0503155	1.07	1
50	30	400	2–3	F503-K3/0,03	2CCF014716R0001	0503216	1.07	1
50	30	400	2.8–4.2	F503-K4,2/0,03	2CCF014717R0001	0503261	1.07	1
50	30	400	3.8–5.8	F503-K5,8/0,03	2CCF014718R0001	0503339	1.07	1
50	30	400	5.3–8	F503-K8/0,03	2CCF014719R0001	0503360	1.07	1
50	30	400	7.3–11	F503-K11/0,03	2CCF014720R0001	0304752	1.07	1
30	30	400	10–15	F503-K15/0,03	2CCF014721R0001	0503131	1.07	1
30	30	400	14–20	F503-K20/0,03	2CCF014722R0001	0503162	1.07	1
30	30	400	18–26	F503-K26/0,03	2CCF014723R0001	0503186	1.07	1
30	30	400	23–32	F503-K32/0,03	2CCF014724R0001	0503223	1.07	1
30	30	400	29–37	F503-K37/0,03	2CCF014725R0001	0503230	1.07	1
30	30	400	34–41	F503-K41/0,03	2CCF014726R0001	0503285	1.07	1
30	30	400	38–45	F503-K45/0,03	2CCF014727R0001	0503308	1.07	1



2CCCF016414R0001

50	30	230/400	0.2–0.3	F504-K0,3/0,03	2CCF016414R0001	0584697	1.4	1
50	30	230/400	0.28–0.42	F504-K0,42/0,03	2CCF015466R0001	0502028	1.4	1
50	30	230/400	0.73–1.1	F504-K1,1/0,03	2CCF010073R0001	0305131	1.4	1
50	30	230/400	1–1.5	F504-K1,5/0,03	2CCF010075R0001	0305148	1.4	1
50	30	230/400	1.4–2.1	F504-K2,1/0,03	2CCF010077R0001	0305155	1.4	1
50	30	230/400	2–3	F504-K3/0,03	2CCF010079R0001	0305162	1.4	1
50	30	230/400	2.8–4.2	F504-K4,2/0,03	2CCF010081R0001	0305179	1.4	1
50	30	230/400	3.8–5.8	F504-K5,8/0,03	2CCF010083R0001	0305186	1.4	1
50	30	230/400	5.3–8	F504-K8/0,03	2CCF010085R0001	0305193	1.4	1
50	30	230/400	7.3–11	F504-K11/0,03	2CCF010087R0001	0305209	1.4	1
30	30	230/400	10–15	F504-K15/0,03	2CCF010089R0001	0305216	1.4	1
30	30	230/400	14–20	F504-K20/0,03	2CCF010091R0001	0305223	1.4	1
30	30	230/400	18–26	F504-K26/0,03	2CCF010093R0001	0305230	1.4	1
30	30	230/400	23–32	F504-K32/0,03	2CCF010095R0001	0305247	1.4	1
30	30	230/400	29–37	F504-K37/0,03	2CCF010097R0001	0305254	1.4	1
30	30	230/400	34–41	F504-K41/0,03	2CCF010099R0001	0305261	1.4	1
30	30	230/400	38–45	F504-K45/0,03	2CCF010101R0001	0305278	1.4	1

Accessory Fitted by the customer

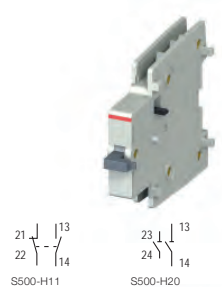

	Order details designation	Order code	GTIN EAN 761227	Weight [kg]	Pack. unit
Auxiliary contact					
1 NO and 1 NC contact	S500-H11	2CCF008681R0001	0305506	0.06	1
2 NO contacts	S500-H20	2CCF008682R0001	0305513	0.06	1

Signal contact					
1 NO and 1 NC contact	S500-S11	2CCF008684R0001	0305537	0.06	1
2 NO contacts	S500-S20	2CCF008685R0001	0305544	0.06	1

Rotary drive for 6 mm spindles					
for 1- to 3-pole circuit breaker	S500-RD3	2CCF014218R0001	0306008	0.08	1
for 4- to 6-pole circuit breaker	S500-RD4	2CCF014219R0001	0306015	0.08	1

Rotary drive for door mounting					
Front plate and switch handle black	S500-H2B1	2CCF014207R0001	0306046	0.07	1
Front plate yellow, switch handle red	S500-H2Y1	2CCF014208R0001	0306053	0.07	1

Rotary drive for door mounting – lockable in OFF-position, door interlock in ON-position					
Front plate and switch handle black	S500-H2B1	2CCF014207R0001	0306046	0.07	1
Front plate yellow, switch handle red	S500-H2Y1	2CCF014208R0001	0306053	0.07	1

Rotary handle for door mounting – door opening possible in ON-position					
Front plate and switch handle black	S500-H2B2	2CCF014209R0001	0306060	0.07	1
Front plate yellow, switch handle red	S500-H2Y2	2CCF014210R0001	0306077	0.07	1

Pistol grip for door mounting					
Black handle	S500-H8B	2CCF014215R0001	0306084	0.14	1
Lower part of handle yellow, handle red	S500-H8Y	2CCF014216R0001	0306091	0.14	1

Name-plate					
black	S500-HP2B	2CCF014211R0001	0306169	0.01	1
yellow	S500-HP2Y	2CCF014212R0001	0306176	0.01	1

Accessory Fitted by the customer

6



2CCC41306RF001



2CCC425005RF001



2CCC425006RF001



2CCC425017RF001

S500-AK20



2CCC425018RF001



2CCC425019RF001

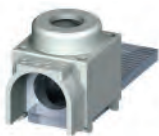

2CCC425012RF001

	Order details designation	Order code	GTIN EAN 761227	Weight [kg]	Pack. unit
Locking device					
Locking device	S500-SA	2CCF008696R0001	0305889	0.02	10

Spindle for rotary handle

length 85 mm / Ø 6 mm	S500-S51	2CCF014213R0001	0306114	0.02	1
length 180 mm / Ø 6 mm	S500-S52	2CCF014214R0001	0306121	0.03	1

Spindle for pistol grip

length 265 mm / Ø 6 mm	S500-S56	2CCF014217R0001	0306138	0.05	1
------------------------	----------	-----------------	---------	------	---

Busbar terminal for vertical pole conductor

Busbar terminal for single-phase busbar system	S500-AK50	2CCF014288R0001	0403652	0.04	10
Busbar terminal	S500-AK20	2CCF011865R0001	0403560	0.01	10

Busbar terminal for three-phase busbar system

L1	S500-L1	2CCF011866R0001	0403577	0.03	10
L2	S500-L2	2CCF011867R0001	0403584	0.03	10
L3	S500-L3	2CCF011868R0001	0403591	0.03	10
N	S500-N	2CCF011869R0001	0403607	0.03	10
NA	S500-NA	2CCF014308R0001	0403669	0.02	10

Insulated terminal for rear connection of main contacts

Terminal, insulated	S500-K1	2CCF008695R0001	0403515	0.01	10
---------------------	---------	-----------------	---------	------	----



2CCC42502CF0001

	Order details designation	Order code	GTIN EAN 761227	Weight [kg]	Pack. unit
Busbar					
8 x 2-pole breakers, length 390 mm	S500-BB28	2CCF016207R0001	0503681	1.59	1
8 x 3-pole breakers, length 590 mm	S500-BB38	2CCF016209R0001	0503704	2.91	1
13 x 3-pole breakers, length 965 mm (maximal)	S500-BB313	2CCF016858R0001	0510443	3.6	1
4 x 4-pole breakers, length 390 mm	S500-BB44	2CCF016676R0001	0510436	2.26	1

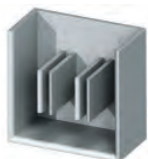

2CCC425010F0001

End cap					
End cap	S500-EK	2CCF016681R0001	0400484	0.02	10



2CCC425013F0001

Line terminal, insulated					
Line terminal 70 mm ²	S500-K2	2CCF016210R0001	0503711	0.03	1
Line terminal 95 mm ²	S500-K3	2CCF016677R0001	0510467	0.07	1



2CCC425011F0001

S500-ME1

Flush-mounting					
Insertion width 38 mm	S500-ME1	2CCF008692R0001	0305902	0.08	1
Insertion width 68 mm	S500-ME2	2CCF008693R0001	0305919	0.10	1
Insertion width 184 mm	S500-ME3	2CCF008694R0001	0305926	0.14	1



2CCC425004F0001

Terminal cover					
Terminal cover	S500-A1	2CCF013615R0001	0403638	0.00	10



2CCC425021F0001



2CCC425022F0001

Intermediate piece					
Intermediate piece 12.5 mm	S500-F1	2CCF014309R0001	0403676	0.02	10
Intermediate piece 6 mm	S500-F2	2CCF016211R0001	0403683	0.01	10

Accessory Factory fitted



	Order details	Weight [kg]	Pack. unit
Switched neutral NA	...- NA	0.21	10
Separating neutral N	...- N	0.07	10
Undervoltage release UA	... + UA 12VAC	0.16	1
	... + UA 24VAC	0.16	1
	... + UA 36VAC	0.16	1
	... + UA 48VAC	0.16	1
	... + UA 110VAC	0.16	1
	... + UA 230VAC	0.16	1
	... + UA 400VAC	0.16	1
	... + UA 500VAC	0.16	1
	... + UA 12VDC	0.16	1
	... + UA 24VDC	0.16	1
	... + UA 36VDC	0.16	1
	... + UA 48VDC	0.16	1
	... + UA 110VDC	0.16	1
	... + UA 230VDC	0.16	1
	... + UA 400VDC	0.16	1
	... + UA 500VDC	0.16	1
Shunt release AL	... + AL 12V	0.17	1
(for AC- and DC-applications)	... + AL 24V	0.17	1
	... + AL 36V	0.17	1
	... + AL 48V	0.17	1
	... + AL 110V	0.17	1
	... + AL 230V	0.17	1
	... + AL 400V	0.17	1
RCD release signal contact T10	T10	0.25	1
(1 NC)			



Table of content S500

Properties of main devices S500

Characteristics	7/2
Special features of S500	7/5
Special features of F500	7/9

Properties of S500 accessories	7/13
--------------------------------	------

High Performance MCB S500

Characteristics of the adjustable and fixed breakers

Characteristics



Tripping characteristic K

Thermal tripping
1.05 ... 1.20 x I_n
Electromagnetic tripping
< 0,21 8 ... 10 x I_n AC
< 0,42 10 ... 12 x I_n AC
> 0,42 12 ... 14 x I_n AC
Calibration temperature 40 °C

As miniature circuit breaker for the protection of single-phase and three-phase motors. For use in fuseless motor control centers (MCC). As circuit breaker with adjustable rated residual operating current, e. g. for transformers.

Tripping characteristic UC-K

Thermal tripping
1.05 ... 1.20 x I_n (DC)
Electromagnetic tripping
< 0,21 8 ... 10 x I_n DC
< 0,42 10 ... 12 x I_n DC
> 0,42 12 ... 14 x I_n DC
Calibration temperature 40 °C

As miniature circuit breaker for circuits and consumers in DC networks and DC driven vehicles. With adjustable rated residual operating current.

Tripping characteristic HV-K

Thermal tripping
1.05 ... 1.20 x I_n
Electromagnetic tripping
12 ... 14 x I_n AC
Calibration temperature 40 °C

As miniature circuit breaker for applications with a rated insulation voltage up to 1000 VAC and/or high ambient temperatures (light systems, mining, tunnelling)

Tripping characteristics

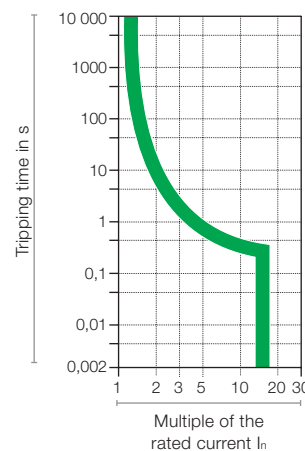
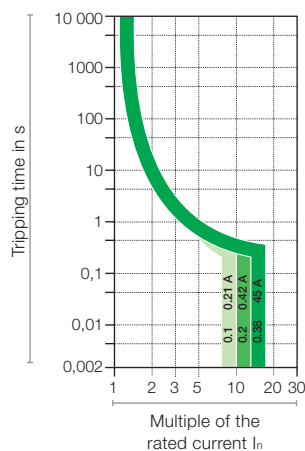
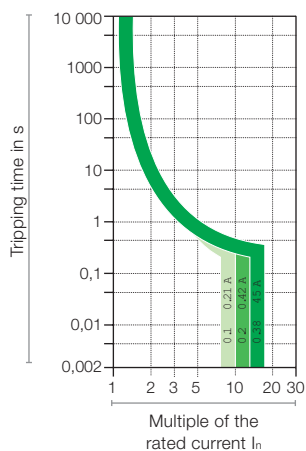

Tripping behaviour compliant to IEC 60947-2

Characteristic	Currents	Thermal tripping		Electromagnetic tripping		
		Small test current	Large test current	Currents	Small test current	Large test current
K	0,1 ... 45	1,05 x I _n	1,20 x I _n	< 0,21 < 0,42 > 0,42	8 x I _n 10 x I _n 12 x I _n	10 x I _n 12 x I _n 14 x I _n
UC-K	0,1 ... 45	1,05 x I _n	1,20 x I _n	< 0,21 < 0,42 > 0,42	8 x I _n (DC) 10 x I _n (DC) 12 x I _n (DC)	10 x I _n (DC) 12 x I _n (DC) 14 x I _n (DC)
HV-K	1 ... 45	1,05 x I _n	1,20 x I _n	-	12 x I _n	14 x I _n

High Performance MCB S500 Characteristics of the F500-K

Characteristics

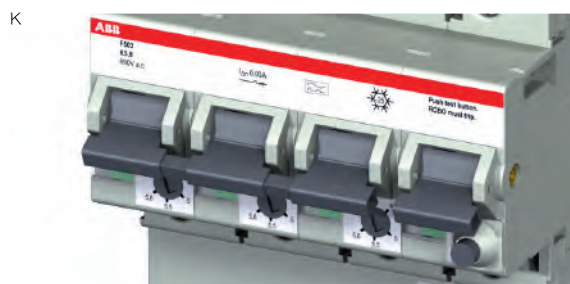

20CC41201ZF001

Tripping characteristic K

Thermal tripping

1.05 ... 1.20 x I_n

Electromagnetic tripping

< 0,21 8 ... 10 x I_n AC

< 0,42 10 ... 12 x I_n AC

> 0,42 12 ... 14 x I_n AC

Calibration temperature 40 °C

Combination circuit breaker with motor protection characteristic and integral residual current protection with I_n = 30 and 300 mA

The high performance miniature circuit breaker F500 protects against the effects of:

- Overload and short-circuits
- Dangerous residual currents
- Direct contact with an active conductor

Tripping characteristics

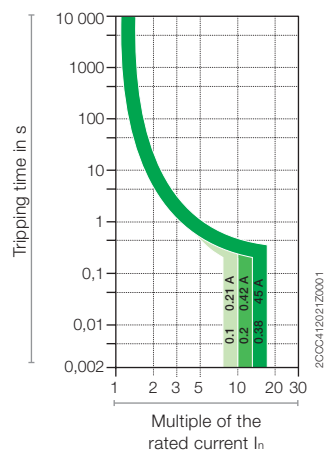

20CC41201ZF001

Tripping behaviour compliant to IEC 60947-2

Characteristic	Currents	Thermal tripping		Electromagnetic tripping		
		Small test current	Large test current	Currents	Small test current	Large test current
K	0,1 ... 45	1,05 x I _n	1,20 x I _n	< 0,21	8 x I _n	10 x I _n
				< 0,42	10 x I _n	12 x I _n
				> 0,42	12 x I _n	14 x I _n

High Performance MCB S500

Characteristics of the X-breaker

Characteristics

X-AG1499



X-AG0084



Tripping characteristic X-AG1499

Thermal tripping
 $1.05 \dots 1.26 \times I_n$
 Electromagnetic tripping
 $16 \dots 24 \times I_n$ AC
 Calibration temperature 40°C

As miniature circuit breaker for high current peaks, e. g. by transformers or condenser batteries.
 With adjustable rated residual operating current.

Tripping characteristic X-AG0084

Electromagnetic tripping
 $12.5 \dots 15 \times I_n$ AC

As circuit breaker developed for high short circuit currents, e. g. by substation distributors or fuseless motor-control-centres (MCC). The breaker dispose of electromagnetic release and thus insensible against temperature fluctuation.

7

Tripping behaviour compliant to IEC 60947-2

Characteristic	Currents	Thermal tripping		Currents	Electromagnetic tripping	
		Small test current	Large test current		Small test current	Large test current
X-AG1499	0,1 ... 45	$1,05 \times I_n$	$1,26 \times I_n$	0,1 ... 45	$16 \times I_n$	$24 \times I_n$
X-AG0084	0,8 ... 63	–	–	–	$12,5 \times I_n$	$15 \times I_n$

Properties

Special features of S500

The high performance MCB S500 – long established

It adds adjustability (among other things) to the S800 range: The S500-K and S500UC-K devices provide the option of infinitely adjusting the rated tripping current. This has the benefit of a very precise tripping operation.

The fixed-setting S500HV-K provides the best solution for applications up to 1000V AC.

For special applications, there is the S500X, which can be configured completely in accordance with the customer's requirements.

The S500X-AG0084 has a fixed setting and is predominantly used for motor protection with separate overload protection.

The S500X-AG1499 can be adjusted; due to its delayed tripping, it is mainly used to protect transformers.

S500-K: Motor protection

The S500-K may be used up to a current rating of 11 A for direct operational switching of motors.

The motor starting time should not be longer than 2,5 seconds to avoid nuisance tripping when motor starting is repeated in quick succession.



- Convincing:** Approved according to UL1077
- Safe:** Optimum coordination with A-contactors
- Loads:** Adjustable range from 0,1 to 45 A
- Checked:** Up to 50 kA rated ultimate short-circuit breaking capacity I_{cu}
- Selectable:** Available as 1- to 4-pole breakers
- Compact:** Minimal dimension
- Flexible:** Wide range of accessories

Coordination table for S500-K motor starter to IEC 60947-4-1, type 2, for 415VAC, 50kA

Motor Rated output P_e [kW]	Rated current I_n [A]	High performance MCB			Contactor		Cable Cross section mm ²	Starter group I_{max} [A]
		Type	Range of adjustment I_n [A]	Magnetic release ($\pm 10\%$) I_m [A]	Type	Safety clearance [mm]		
0.12	0.44	S503-K0,58	0.38–0.58	7	A9-30-10	20	1.5	0.58
0.18	0.72	S503-K0,8	0.53–0.8	10	A9-30-10	20	1.5	0.8
0.25	0.83	S503-K1,1	0.73–1.1	13	A9-30-10	20	1.5	1.1
0.37	1.12	S503-K1,5	1–1.5	18	A9-30-10	20	1.5	1.5
0.5	1.45	S503-K2,1	1.4–2.1	25	A9-30-10	20	1.5	2.1
0.75	1.9	S503-K2,1	1.4–2.1	25	A9-30-10	20	1.5	2.1
1.1	2.59	S503-K3	2–3	36	A12-30-10	20	1.5	3
1.5	3.45	S503-K4,2	2.8–4.2	50	A12-30-10	20	1.5	4.2
1.85	4.4	S503-K5,8	3.8–5.8	69	A16-30-10	20	1.5	5.8
2.2	4.8	S503-K5,8	3.8–5.8	69	A16-30-10	20	1.5	5.8
3	6.48	S503-K8	5.3–8	96	A16-30-10	20	1.5	8
4	8.6	S503-K11	7.3–11	132	A26-30-10	35	1.5	11
5.5	11.1	S503-K15	10–15	180	A26-30-10	35	1.5	15
7.5	14.8	S503-K20	14–20	240	A26-30-10	35	1.5	20
11	21.5	S503-K26	18–26	312	A26-30-10	35	2.5	26
15	28.5	S503-K32	28–32	384	A30-30-10	35	6	32
18.5	35	S503-K37	29–37	444	A40-30-10	35	6	37
22	41	S503-K45	38–45	540	A50-30-00	35	10	45

Properties

Special features of S500



20CC412001F0001

S500UC-K: DC circuit protection

The S500UC-K is intended for DC applications. Voltages up to 250VDC per pole can be switched with time constants ≤ 15 ms. Higher voltages up to 750VDC are switched by series connection (polarity-independent).

- Convincing:** Approved according to UL1077
- Safe:** Independent polarity connection
- Loads:** Range of adjustment from 0,1 to 45 A
- Checked:** Up to 30kA rated ultimate short-circuit breaking capacity I_{cu}
- Selectable:** Available as 1- to 4-pole breaker
- Compact:** Smallest sizes
- Flexible:** Wide range of accessories

S500UC-K: Up to 250 VDC each pole

The S500UC-K is only for DC applications.

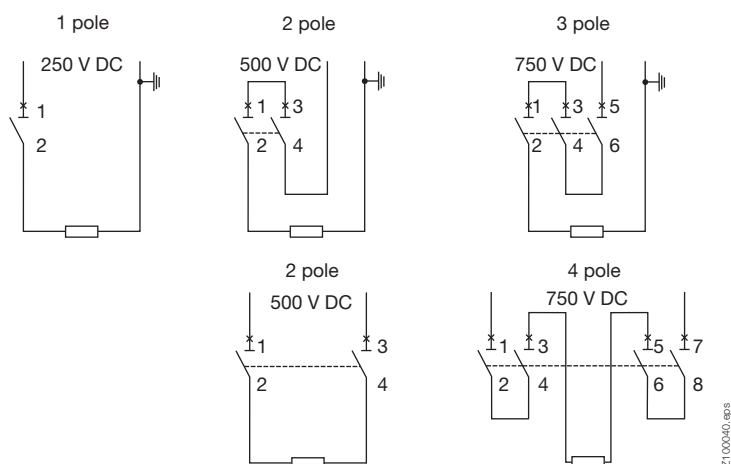

Z100040.eps

7 Earthed network

Unearthed network



20CC412003F0001

S500HV-K: For applications up to 1000 VAC

The S500HV has a fixed rated current. It is used as high performance MCB for applications up to 1000VAC – from the mining industry excess the power distribution up to tunnelling. Between two S500HV-K (1, 2 or 3 poles) or a S500HV-K and a conductive part, the 12,5 mm separating barrier S500-F1 must be installed. The separating barrier must be ordered separately.

- Convincing:** Can be used up to 1000 VAC
- Safe:** Reliable for high ambient temperatures
- Loads:** Available from 1 to 45 A
- Checked:** Up to 1,5kA rated ultimate short-circuit breaking capacity I_{cu}
- Selectable:** Available as 1- to 3-pole breaker
- Compact:** Smallest sizes
- Flexible:** Wide range of accessories

S500X: Customized circuit breaker

The S500X is a customized breaker and suitable for special applications.

Following adjustments can be conducted:

- Special ambient temperature
- Special trip characteristics through adaptation of thermal and/or electromagnetic release
- Calibration of intermediate values

The marking of S500X varies in the identification number, characterized by 2 letters and 4 digits.

- Convincing:** Customized breaker
- Safe:** Available with fixed or adjustable rated current
- Loads:** Available with max. 63 A
- Checked:** Up to 50 kA rated ultimate short-circuit breaking capacity I_{cu}
- Compact:** Smallest sizes
- Flexible:** Wide range of accessories

Fixed version Rated current [A]	Adjustable version Range of adjustment [A]
6	0.1–0.15
10	0.14–0.21
13	0.2–0.3
16	0.28–0.42
20	0.53–0.8
25	0.73–1.1
32	1–1.5
40	1.4–2.1
50	2–3
63	2.8–4.2
	3.8–5.8
	5.3–8
	7.3–11
	10–15
	14–20
	18–26
	23–32
	29–37
	34–41
	38–45



S500X-AG1499: Protection of transformers

The S500X-AG1499 is prevailing used to protect transformers. The late magnetic release and the high rated ultimate short-circuit breaking capacity of up to 50kA makes this breaker unique.

- Convincing:** Can be used up to 690 VAC
- Safe:** Magnetic release is between 16 to 21 x I_n
- Loads:** Available from 1,6 to 63 A
- Checked:** Up to 50 kA rated ultimate short-circuit breaking capacity I_{cu}
- Compact:** Smallest sizes
- Flexible:** Wide range of accessories

Properties

Special features of S500



S503X-AG0084: Motor protection up to 50 kA

The S503X-AG0084 is suitable for high short-circuit currents with an rated ultimate short-circuit breaking capacity up to 50 kA.

- Convincing:** Can be used up to 690 VAC
- Safe:** Possesses only an electromagnetic release
- Loads:** Available from 0.8 to 63 A
- Checked:** Up to 50 kA rated ultimate short-circuit breaking capacity I_{cu}
- Compact:** Smallest sizes
- Flexible:** Wide range of accessories

Coordination table S503X-AG0084 to IEC 60947-4-1, type 2, for 400 VAC, 65 kA with A-conductor and thermal overload relay

Motor Rated output P_e [kW]	Rated current I_n [A]	High performance MCB			Contactor		Thermal overload relay		Cable Cross section [mm ²]	Starter group I_{max} [A]
		Type	Rated current I_n [A]	Magnetic release ($\pm 10\%$) I_m [A]	Type	Safety clearance [mm]	Type	Range of adjustment [A]		
0.12	0.44	S503X-AG0084	1.6	22	A9-30-10	20	TA25 DU 0.63	0.4–0.63	1.5	0.63
0.18	0.60	S503X-AG0084	1.6	22	A9-30-10	20	TA25 DU 1.00	0.63–1	1.5	1
0.25	0.85	S503X-AG0084	1.6	22	A9-30-10	20	TA25 DU 1.00	0.63–1	1.5	1
0.37	1.10	S503X-AG0084	1.6	22	A9-30-10	20	TA25 DU 1.4	1–1.4	1.5	1.4
0.55	1.15	S503X-AG0084	2.5	34	A9-30-10	20	TA25 DU 1.8	1.3–1.8	1.5	1.8
0.75	1.9	S503X-AG0084	2.5	34	A9-30-10	20	TA25 DU 2.4	1.7–2.4	1.5	2.4
1.1	2.70	S503X-AG0084	4.0	55	A9-30-10	20	TA25 DU 3.1	2.2–3.1	1.5	3.1
1.5	3.60	S503X-AG0084	6.0	83	A9-30-10	20	TA25 DU 4	2.8–4	1.5	4
2.2	4.90	S503X-AG0084	6.0	83	A12-30-10	20	TA25 DU 6.5	4.5–6.5	1.5	6.5
3	6.50	S503X-AG0084	9.0	124	A12-30-10	20	TA25 DU 8.5	6–8.5	1.5	8.5
4	8.50	S503X-AG0084	20.0	275	A16-30-10	35	TA25 DU 11	7.5–11	1.5	11
5.5	11.50	S503X-AG0084	20.0	275	A16-30-10	35	TA25 DU 14	10–14	1.5	14
7.5	15.50	S503X-AG0084	20.0	275	A26-30-11	35	TA25 DU 19	13–19	1.5	19
11	22	S503X-AG0084	32.0	440	A20-30-10	35	TA25 DU 25	18–25	2.5	25
11	22	S503X-AG0084	32.0	440	A26-30-10	35	TA25 DU 25	18–25	4	25
15	29	S503X-AG0084	32.0	440	A30-30-10	35	TA25 DU 32	24–32	6	32
18.5	35	S503X-AG0084	52.0	715	A40-30-10	35	TA25 DU 42	29–42	6	42
22	41	S503X-AG0084	63.0	865	A50-30-00	35	TA25 DU 52	36–52	10	52

Maximum cable lengths for protection against indirect contact (earth leakage current) to IEC 364-4-41

High performance MCB Type	Rated current I_n [A]	Maximum permissible cable lengths and cross-sections					
		Magnetic release ($\pm 10\%$) I_m [A]	1.50 mm ² L [m]	2.50 mm ² L [m]	4.00 mm ² L [m]	6.00 mm ² L [m]	10.00 mm ² L [m]
S503X-AG0084	1.6	22	815	1360	–	–	–
S503X-AG0084	2.5	34	525	880	–	–	–
S503X-AG0084	4	55	325	540	870	–	–
S503X-AG0084	6	83	215	360	575	865	–
S503X-AG0084	9	124	145	240	385	580	965
S503X-AG0084	20	275	65	110	175	260	435
S503X-AG0084	32	440	–	70	110	160	270
S503X-AG0084	52	715	–	–	–	100	170
S503X-AG0084	63	865	–	–	–	80	140

Properties

Special features of F500



20CC42302F0001

F500-K: RCD with motor protection

The F500-K is an overcurrent breaker with motor protection characteristic. The residual current protection release is effective with sinusoidal alternating and pulsating DC fault current (Type A, according to IEC 60947-2, Annex B).

The high performance breaker F500-K ensures special protection in high power networks against:

- Dangerous residual currents at excessive contact voltage by physical contact
- Overheating of electrical operating equipment (motors) by overcurrent
- Overload and short-circuit

Convincing: High rated operating voltage up to 690 VAC

Safe: No thermal release required on contactor

Loads: Switching of all poles in event of a fault

F500S...0.3 S: Selective RCD with overload protection

The delayed RCD circuit breaker also bears the the symbol S in addition to its type designation. The F500S...0.3 S selective residual current circuit breakers ensure selectivity with respect to following sensitive RCD circuit breakers. F500S...0.3S selective residual current circuit breakers are only used for material protection.

Subsequent short-time delayed G-types also behave selectively if connected after a F500S...0.3 S.

Capacitive discharge currents accompanied by high current peaks can be caused by:

- Long line capacitances
- Large number of fluorescent lamps (particularly when using electronic ballast units)
- Electronic equipment and components (PC terminals, PLCs, voltage converters, etc.)
- Transient network overvoltages

Convincing: High rated operating voltage up to 400/690 VAC

Safe: High rated breaking capacity, 50 kA at 230/400 VAC

Loads: Clear contact position indication for all poles

Checked: RCD pulsating DC sensitivity
(Type A, according to IEC 60947-2, Annex B)

Flexible: Available with various rated tripping current

Overview accessory

Accessory for breakers

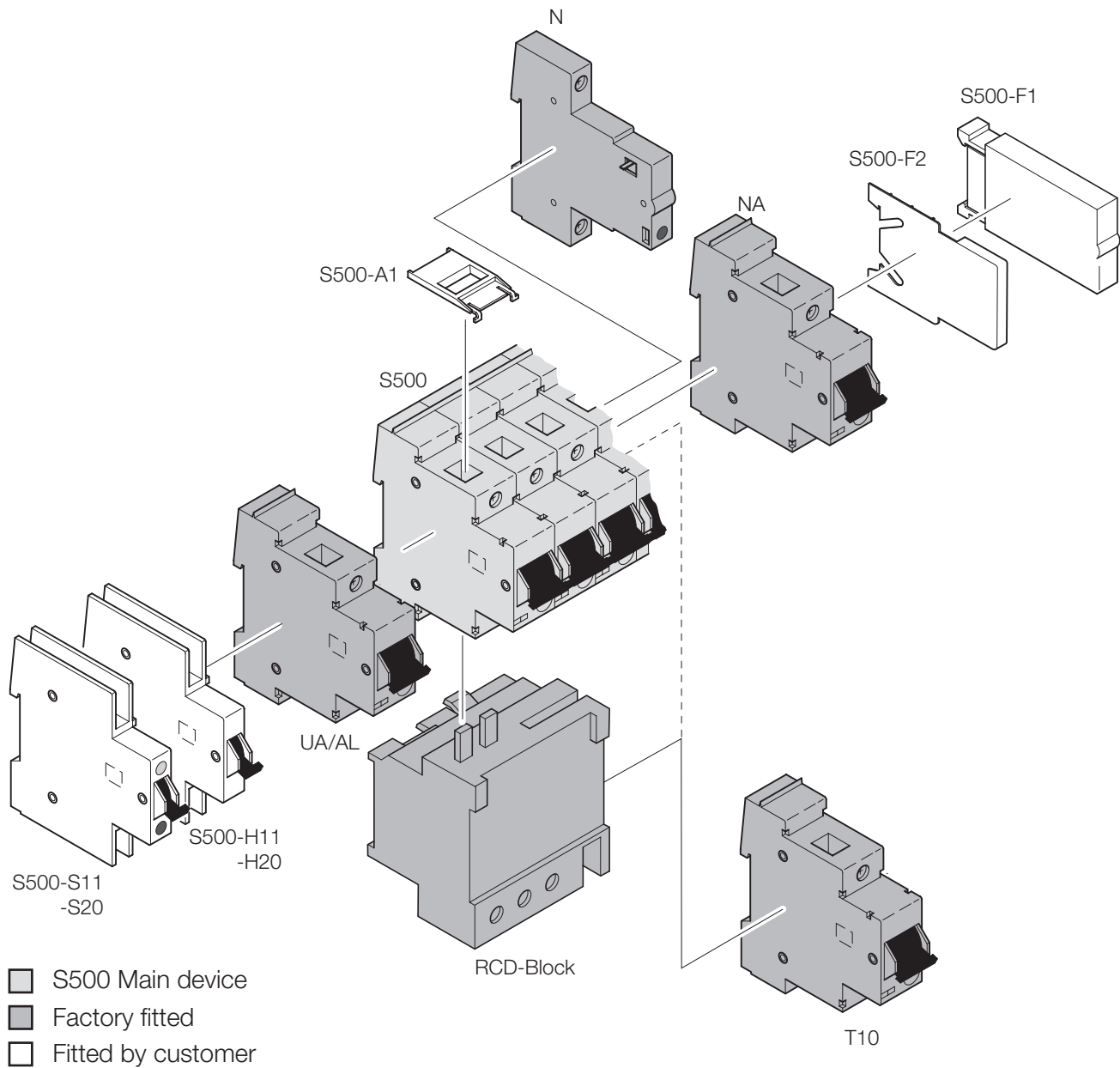

Overview accessory

Common accessory

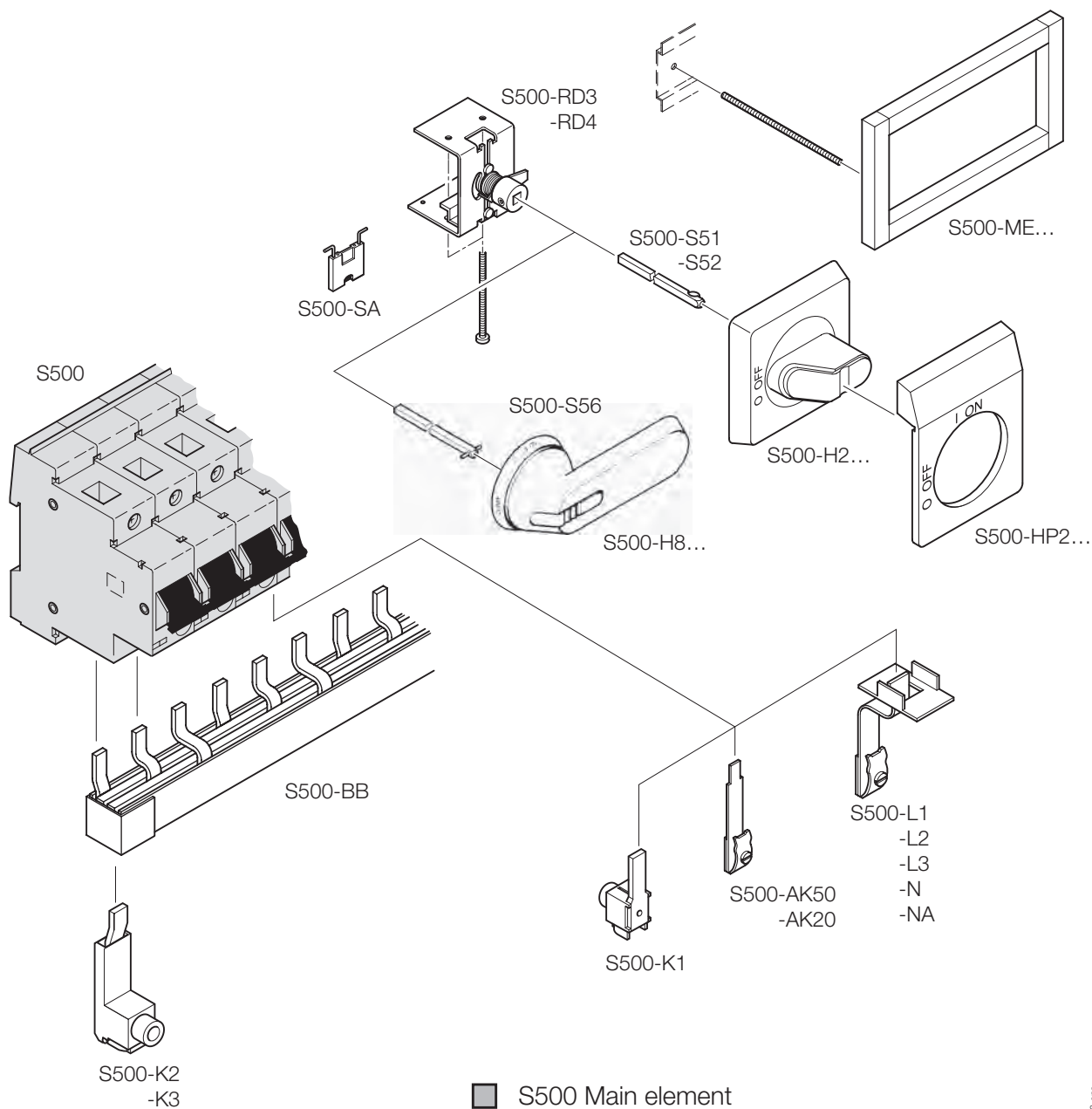

Supplied from above or below

Z100083.eps

Properties Accessories

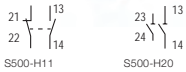

S500-H11, -H20 Auxiliary contact

The auxiliary contact is for electrical display of the operating state of the high performance MCB S500. Both changeover contacts always switch simultaneously with the live conductor contact and detect the following operating states:

- Manual tripping
- Tripping due to thermal overload
- Tripping due to magnetic overload (short-circuit)

Mounting ability of the auxiliary contact S500-H11, -H20

The auxiliary contacts can be mounted at the left on the high performance MCB S500. Max. 2 auxiliary contacts can be fitted per high performance MCB S500.



S500-S11, -S20 Signal contact

The signal contact is used for electrical signaling of the operating state of the high performance MCB S500. Signal contact switches resp. detect following form of tripping:

- Tripping due to thermal overload
- Tripping due to magnetic overload (short-circuit)
- Residual current tripping
- Tripping by residual current release

Mounting ability of the signal contacts S500-S11, -S20

The signal contacts can be mounted at the left on the high performance MCB S500. Max. 1 signal contacts can be fitted per high performance MCB S500. When using auxiliary and signal contacts the auxiliary contact must first be snapped directly onto the circuit breaker S500.

On each circuit breaker can be fitted:

- 1 Auxiliary contact
- or 1 Signal contact
- or 2 Auxiliary contacts
- or 1 Auxiliary- and 1 signal contact

...NA

Switched neutral conductor

The switched neutral conductor switches simultaneously with the high performance MCB S500.

Mounting ability of the switched neutral conductor ...NA

The neutral conductor is be mounted by the factory at the right on the high performance MCB S500.

...N

Separating neutral conductor

The S500 high performance MCB is force-opened before actuating the separating neutral conductor.

Mounting ability of the separating neutral conductor ...N

The separating neutral conductor is be mounted by the factory at the right on the high performance MCB S500.



...+UA

Undervoltage release

The ...+UA undervoltage release can be used as an emergency-stop cut-as by use of suitable emergency stop buttons. The undervoltage release switches the power supply to the high performance MCB off in case of a failure or if the value falls below $0.7 \times U_n$. After tripping, the high performance MCB can be switched back on as soon as the voltage is over $0.85 \times U_n$.

Mounting ability of the undervoltage release ...+UA

The undervoltage release is be mounted by the factory at the left side of the high performance MCB S500.



...+AL

Shunt release

The ...+AL shunt opening release is for remote release of the S500 high performance MCB using an electrical impulse (no persistent command). Operation of the trigger is guaranteed at a voltage between 70% and 110% of the rated mains voltage U_n both for AC and DC.

Mounting ability of the shunt release ...+AL

The shunt release is be mounted by the factory at the left side of the high performance MCB S500.

T10

RCD release signal contact

The T10 opens when FI trips, and is used for displaying residual current tripping operations. Pressing test button T trips the F500. Signalling can be tested using the FI signal contact T10. When operated manually (ON/OFF), the FI signal contact does not display any tripping operation. If using an auxiliary and signal contact, the following tripping operations may be displayed:

- Tripping due to pressing test button T
- Tripping due to thermal overload
- Tripping due to a magnetic overload (short circuit)
- Tripping due to undervoltage releases or operating current releases
- Tripping due to residual current tripping operations

With the FI signal contact T10, the user has a further option at their disposal for detecting and differentiating between fault causes.

Application with FI signal contact T10

Signalling specific FI tripping operations in:

- Hospitals
- Industrial plants
- Laboratories
- Telecommunications
- Systems with a great demand for high current availability

Mounting ability of the RCD release signal contact T10

The RCD release signal contact is be mounted by the factory at the right side of the pole of the residual current circuit breaker F500.



S500-SA

Locking device

The locking device safely prevents unintentional switching on and off of the S500. Simply insert the lug of the locking device through the borehole on the high performance MCB S500 and lock with a padlock with lug diameter of max 4mm (not included in delivery). Even when the high performance MCB S500 is secured with an locking device against unintentional switching off, tripping remains possible in case of overload or short-circuit by the undervoltage- and shunt release.

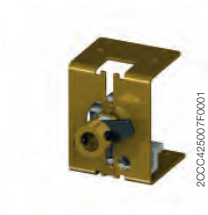

S500-RD3

Rotary drive

The rotary drive for 1-3 pole or 4-6 pole devices can be delivered for assembly on the switching field door. To the rotary drive are various rotary handles and a pistol grip available. The rotary handles avoid the switching-on of the high performance MCB S500. They could be locked in OFF position and the door lock takes place in ON position except of S500-H2B2 and S500-H2Y2 they permit the opening of the cabinet door.

- Spindle for rotary drive
 - (85 mm) S500-S51
 - (180 mm) S500-S52
- Spindle for pistol grip
 - (265 mm) S500-S56
- Pistol grip S500-H8B, -H8Y
- Rotary drive S500-H2B2, -H2Y2, H2B1, -H2Y1
- Name plate S500-HP2B, -HP2Y



S500 Busbar terminal

Busbar terminals are used for powering live conductors arranged vertically or horizontally. Individual devices can be replaced at a later stage without tripping the busbars.

Max. connection cross-section are:

- Round conductor 50 mm² oder 16 mm²
- Square 36 mm² oder 20 mm²
- Flat copper 6 x 20 mm oder 5 x 10 mm

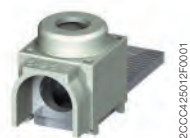

S500-K1 Terminal, insulated

The insulated terminal is for rear connection of the main contacts. The connection cross-section is max. 25 mm² for copper cable or strand.



S500 Busbar system

The S500 busbar system is comprised of:

- Busbar
- End cape
- Line terminal, insulated

The comb-shaped busbar is used for powering horizontally arranged live conductors. In addition to the comb-shaped busbar, the system incorporates the insulating cover and end caps.

The max. rated operational voltage U_n is 400/690 V a.c.

Conductor cross-section is 35 mm². The power can be supplied from centre or from the side – for supply from centre, 250 A is the maximum. For supply from the side, 125 A is the maximum.

The S500-BB44 comb-shaped busbar is for 4 x 4-pin switches with separate neutral conductor bar, and can be used for 3-pin switches with auxiliary and/or signal contact.

The S500-EK end cap is used as contact protection after cutting the busbars to length.

The line terminal is intended either for 2 and 3-pin S500-K2 or 4-pin S500-K3 comb-shaped busbars.

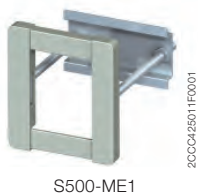
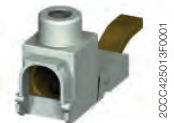

Flush-mounting

The flush-mounting is for fitting in front panel or door.

- | | |
|----------|------------------------|
| S500-ME1 | insertion width 38 mm |
| S500-ME2 | insertion width 88 mm |
| S500-ME3 | insertion width 184 mm |



S500-A1 Terminal cover

The terminal cover is for insulation the connecting terminal according to IP40.



Intermediate piece

The intermediate piece is for compensating the unit widths of 18 mm.

- | | |
|---------|--------------|
| S500-F1 | 12,5 mm wide |
| S500-F2 | 6 mm wide |

Rated short-circuit breaking capacity I_{cn}

Compliant to EN 60898-1

The maximum current which a switching device can switch off without damage at a rated operational voltage and rated operational frequency. It is specified as an effective value.

Rated ultimate short-circuit braking capacity I_{cu}

Compliant to EN 60947-2

Ultimate short-circuit breaking capacity that a circuit breaker can switch off without damage at a rated operational voltage and rated operational frequency. It is specified as an effective value.

Rated service short-circuit breaking capacity I_{cs}

Compliant to EN 60947-2

Service short-circuit breaking capacity that a circuit breaker can switch off without damage at a rated operational voltage and rated operational frequency. It is specified as an effective value.

Rated insulation voltage U_i

The rated insulation voltage (U_i) is the voltage to which dielectric checks and creepage distances refer.

The maximum rated operational voltage must not exceed its rated insulation voltage.

Rated impulse withstand voltage U_{imp}

Peak of a withstand voltage of a specified form and polarity with which the circuit can be loaded under specified test conditions without a breakdown and to which clearances relate.

The rated impulse withstand voltage must be equal to or greater than the values of the withstand over-voltages (transient overvoltages) which occur in the System in which the device is used.

Backup protection

Assignment of two overcurrent protective devices in series, where the protective device, generally but not necessarily on the supply side, effects the overcurrent protection with or without the assistance of the other protective device and prevents excessive stress on the latter [IEC 60947-1, definition 2.5.24].

Total selectivity

Overcurrent discrimination where, in the presence of two overcurrent protective devices in series, the protective device on the load side effects the protection without causing the other protective device to operate [IEC 60947-2, definition 2.17.2].

Partial selectivity

Overcurrent discrimination where, in the presence of two overcurrent protective devices in series, the protective device on the load side effects the protection up to a given level of overcurrent, without causing the other protective device to operate [IEC 60947-2, definition 2.17.3].

Table of content S500

Technical data

S500-K	8/2
S500UC/S500HV	8/4
S500X-AG1499	8/5
S500X-AG0084	8/6
F500	8/7
Internal resistance/Power loss	8/8
Accessories	8/9

230 V Let-through energies

S500-K	8/10
S500HV	8/12

Technical data

S500-K

		S500	
		K	
Characteristics			
Rated continuous current I_n adjustable	A	0.1 ... 45	
Poles		1, 2, 3+N, NA ^{1,2}	
Rated operating voltage U_e	V	AC 400/690	
Rated insulation voltage U_i	V	AC 690	
Rated impulse withstand voltage U_{imp}	kV	6	
Ultimate short-circuit breaking capacity I_{cu} compliant to 60947-2		0.1 ... 11A	10 ... 45A
AC 230/400V	kA	50	30
AC 250/440V	kA	30	25
AC 3 x 500V	kA	20	15
AC 400/690V	kA	6	6
Service short-circuit breaking capacity I_{cs} compliant to 60947-2		0.1 ... 11A	10 ... 45A
AC 230/400V	kA	30	25
AC 250/440V	kA	22	22
AC 3 x 500V	kA	15	11
AC 400/690V	kA	3	3
Rated short-circuit breaking capacity I_{cs} compliant to UL1077 and CSA-C22.2 No. 35		≤ 25A	> 25A ... 45A
AC 240/415V	kA	30	18
AC 277/480V	kA	14	14
AC 346/600V	kA	6	6
Rated frequency	Hz	50/60	
Mounting position		any	
Disconnecter properties compliant to IEC 60947-2		yes	
Standards		IEC 60947-2 UL 1077 CAN/CSA-C22.2 No. 35	
Connections C_u	mm ²	1 ... 25	
Tightening torque	Nm	2.5	
Feed AC		any	
Permissible operating ambient temperature	C	-25 ... +55	
Protection category		IP20	
Mech. lifetime		> 20 000 switching cycles	
Climatic strength		DIN 50016	

¹ N = for separating neutral isolation

² NA = switched neutral

Technical data

S500-K

Adjustable version

Rated current I_n [A]	S500-K Internal resistance/Pole R_i [Ω]	Power loss* P_v [W]
0.1–0.15	78	1.76
0.14–0.21	48	2.12
0.2–0.3	23.5	2.12
0.28–0.42	12.3	2.17
0.38–0.58	6.6	2.22
0.53–0.8	3.5	2.24
0.73–1.1	2.0	2.42
1–1.5	1.05	2.36
1.4–2.1	0.68	3.00
2–3	0.35	3.15
2.8–4.2	0.175	3.09
3.8–5.8	0.095	3.20
5.3–8	0.055	3.52
7.3–11	0.035	4.24
10–15	0.023	5.18
14–20	0.012	4.80
18–26	0.008	5.41
23–32	0.0055	5.63
29–37	0.0035	4.79
34–41	0.0025	4.20
38–45	0.0017	3.44

Internal resistance and power losses concerning the ambient temperature

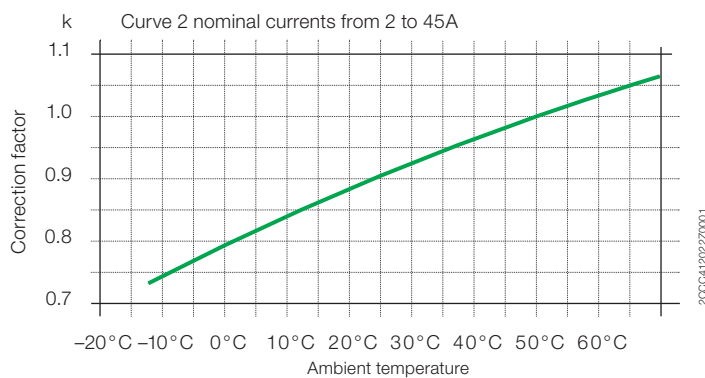
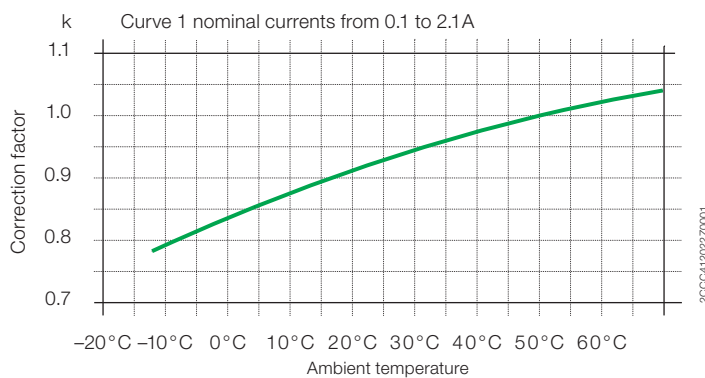

Example:

Motor 2.2 kW; $I_e = 5$ A at 380 V a.c. for 0°C ambient temperature
 High performance circuit breaker S500-K 3.8 ... 5.3 A
 According to curve 2 correction factor $k = 0.84$
 Current setting on S500-K breaker: $k \times I_e = 0.84 \times 5 \text{ A} = 4.2 \text{ A}$

Technical data

S500UC/S500HV

		S500UC
Characteristics		K
Rated continuous current I_n adjustable	A	0.1 ... 45
Poles		1 ... 4
Rated operating voltage U_e (DC/Pol)	V	DC 250 / per pole max. DC 750 / 3 poles in serie
Rated insulation voltage U_i	V	DC 1000
Rated impulse withstand voltage U_{imp}	kV	6
Ultimate short-circuit breaking capacity I_{cu} compliant to 60497-2		
(DC) 250 V L/R 15 ms (1-pole)	kA	30
(DC) 500 V L/R 15 ms (2-pole)	kA	30
(DC) 750 V L/R 15 ms (3-pole)	kA	30
(DC) 750 V L/R 15 ms (4-pole)	kA	30
Rated short-circuit breaking capacity compliant to UL1077 and CSA		
(DC) 250 V (1-pole)	kA	30
(DC) 500 V (2 poles in series)	kA	30
(DC) 600 V (3 and 4 poles in series)	kA	30
Mounting position		any
Disconnecter properties compliant to IEC 60947-2		yes
Standards		IEC 60947-2 UL 1077 CAN/CSA-C22.2 No. 35
Connections C_u	mm ²	1 ... 25
Tightening torque	Nm	2.5
Feed		any
Permissible operating ambient temperature	°C	-25 ... +55
Protection category		IP20
Mech. lifetime		> 20 000 switching cycles
Climatic strength		DIN 50016
Approvals		UL1077 File E167556

		S500HV
Characteristics		K
Rated continuous current I_n	A	1 ... 45
Poles		1 ... 3
Trip class of thermal release		Class 10A
Rated operating voltage U_e	V	AC 580 / 1000
Rated insulation voltage U_i	V	AC 1000
Rated impulse withstand voltage U_{imp}	kV	6
Ultimate short-circuit breaking capacity I_{cu} / I_{cs} compliant to 60947-2		
(AC) 580/1000V	kA	1.5
Rated frequency	Hz	50/60
Permissible operating ambient temperature	°C	-25 ... +55
Climatic resistance		DIN 50016
Protection category		IP40
Plastic		halogen-free
Disconnecter properties compliant to IEC 60947-3		yes
Standards		IEC 60947-2, SEMKO
Mounting position		any
Connections C_u	mm ²	1 ... 25
Tightening torque		2.5
Feed AC		any

Technical data

S500X-AG1499

		S500X-AG1499	
Rated continuous current I_n adjustable	A	0.1 ... 45	
Poles		1 ... 3	
Rated operating voltage U_e	V	AC 400/690	
Rated insulation voltage U_i	V	AC 690	
Rated impulse withstand voltage U_{imp}	kV	6	
Ultimate short-circuit breaking capacity I_{cu} compliant to 60947-2		0.1 ... 11A	10 ... 45A
AC 230/400V	kA	50	30
AC 250/440V	kA	30	25
AC 3 x 500V	kA	20	15
AC 400/690V	kA	6	6
Service short-circuit breaking capacity I_{cs} compliant to 60947-2		0.1 ... 11A	10 ... 45A
AC 230/400V	kA	30	25
AC 250/440V	kA	22	22
AC 3 x 500V	kA	15	11
AC 400/690V	kA	3	3
Rated short-circuit breaking capacity I_{cc} compliant to UL1077 and CSA 22.2 No. 35		≤ 25A	> 25A ... 45A
AC 240/415V	kA	30	18
AC 277/480V	kA	14	14
AC346/600V	kA	6	6
Rated frequency	Hz	50/60	
Mounting position		any	
Disconnecter properties compliant to IEC 60947-3		yes	
Connections C_u	mm ²	1 ... 25	
Tightening torque	Nm	2.5	
Feed AC		any	
Permissible operating ambient temperature	°C	-25 ... +55	
Protection category		IP20	
Mech. lifetime		> 20 000 switching cycles	
Climatic strength		DIN 50016	
Standards		IEC 60947-2	
		UL 1077	
		CAN/CSA-C22.2 No. 35	
Approvals		UL 1077	
		File E167556	

Technical data

S503X-AG0084

		S503X-AG0084
Rated continuous current I_n	A	0.8 ... 63
Poles		3+N ¹
Rated operating voltage U_e	V	AC 230/400
Rated insulation voltage U_i	V	AC 690
Rated impulse withstand voltage U_{imp}	kV	6
Ultimate short-circuit breaking capacity I_{cu} compliant to 60947-2	kA	50
Service short-circuit breaking capacity I_{cs} compliant to 60947-2	kA	25
Rated frequency	Hz	50/60
Mounting position		any
Disconnecter properties compliant to IEC 60947-2		yes
Standards		IEC 60947-2
Connections C_u	mm ²	1 ... 25
Tightening torque	Nm	2.5
Feed AC		any
Permissible operating ambient temperature	°C	-25 ... +55
Protection category		IP20
Mech. lifetime		> 20 000 switching cycles
Climatic strength		DIN 50016

¹ N = separating neutral isolation

Technical data

F500

		F500	
		K	
Characteristics			
Rated continuous current I_n	A	0.2 ... 45	
Rated residual operating current $I_{\Delta n}$	A	0.01 / 0.03 / 0.3	
with short-term delay	A	0.03	
selective	A	0.3	
Pole		2 ... 4	
Rated operating voltage U_n 50/60 Hz			
(AC) 50/60 Hz	V	AC 400, 500, 690	
Rated insulation voltage U_i	V	AC 690	
Rated short-circuit breaking capacity I_{cn} nach EN/IEC 60898-1			
AC 230/400V	kA	25	
Service short-circuit capacity I_{cs} nach EN/IEC 60898-1			
AC 230/400V	kA	12.5	
Ultimate short-circuit breaking capacity I_{cu} compliant to 60947-2			
		0.2 ... 11A	10 ... 45A
AC 230/400V	kA	50	30
AC 250/440V	kA	30	25
AC 3 x 500V	kA	20	15
AC 400/690V	kA	6	6
Service short-circuit breaking capacity I_{cs} compliant to 60947-2			
		0.2 ... 11A	10 ... 45A
AC 230/400V	k	30	25
AC 250/440V	kA	22	22
AC 3 x 500V	kA	15	11
AC 400/690V	kA	3	3
Rated frequency	Hz	50/60	
Mounting position		any	
Disconnecter properties compliant to IEC 60947-2		yes	
Standards		IEC 60947-2	
Connections C_u	mm ²	1 ... 25	
Tightening torque	Nm	2.5	
Feed AC		any	
Permissible operating ambient temperature	°C	-25 ... +40	
Protection category		IP20	
Mech. lifetime		> 10 000 switching cycles	
Climate strength		IEC 60068-2-30	

Power loss/Internal resistance per pole

Fixed version/adjustable version

Fixed version

Rated current I_n [A]	S500X-AG0084	
	Internal resistance/Pole R_i [m Ω]	Power loss P_v [W]
1.6	950	2.43
2.5	500	3.13
4	195	3.12
6	90	3.24
9	45	3.65
20	12	4.8
32	5.5	5.63
52	1.7	4.6
63	1.7	6.75

Adjustable version

Rated current I_n [A]	S500-K		S500UC-K		S500X-AG1499		F500-K	
	Internal resistance/pole R_i [Ω]	Power loss P_v [W]	Internal resistance/pole R_i [Ω]	Power loss P_v [W]	Internal resistance/pole R_i [Ω]	Power loss P_v [W]	Internal resistance/pole R_i [Ω]	Power loss P_v [W]
0.1–0.15	78	1.76	84	1.89	78	1.76		
0.14–0.21	48	2.12	51	2.25	48	2.12		
0.2–0.3	23.5	2.12	25.5	2.30	23.5	2.12		
0.28–0.42	12.3	2.17	12.8	2.26	12.3	2.17	12.4	2.19
0.38–0.58	6.6	2.22	7.0	2.35	6.6	2.22	6.7	2.25
0.53–0.8	3.5	2.24	3.6	2.30	3.5	2.24	3.6	2.30
0.73–1.1	2.0	2.42	2.04	2.47	2.0	2.42	2.1	2.54
1–1.5	1.05	2.36	1.08	2.43	1.05	2.36	1.1	2.48
1.4–2.1	0.68	3.00	0.68	3.00	0.68	3.00	0.73	3.22
2–3	0.35	3.15	0.35	3.15	0.35	3.15	0.3507	3.16
2.8–4.2	0.175	3.09	0.175	3.09	0.175	3.09	0.1757	3.10
3.8–5.8	0.095	3.20	0.095	3.20	0.095	3.20	0.0957	3.22
5.3–8	0.055	3.52	0.055	3.52	0.055	3.52	0.0557	3.56
7.3–11	0.035	4.24	0.035	4.24	0.035	4.24	0.0357	4.32
10–15	0.023	5.18	0.023	5.18	0.023	5.18	0.0237	5.33
14–20	0.012	4.80	0.012	4.80	0.012	4.80	0.0127	5.08
18–26	0.008	5.41	0.008	5.41	0.008	5.41	0.0087	5.88
23–32	0.0055	5.63	0.005	5.12	0.0055	5.63	0.0062	6.35
29–37	0.0035	4.79	0.0035	4.79	0.0035	4.79	0.0042	5.75
34–41	0.0025	4.20	0.0025	4.20	0.0025	4.20	0.0032	5.38
38–45	0.0017	3.44	0.0017	3.44	0.0017	3.44	0.0024	4.86

Technical data

Accessories

Electrical properties

Auxiliary- and signal contact		
Utilisation categories compliant to 60947-5-1		AC15 230V/2A AC15 400V/1A DC13 250V/0.5A
Utilisation categories compliant to 60947-4-1		AC1 400V/6A
Ratings compliant to UL1077		120 VAC 3A 240 VAC 1.5A 480 VAC 6A 125 VDC 0.5A 12 VDC 10 mA
Thermal continuous current I_{th}	A	6
Rated operating voltage U_e	V	AC 690
Rated operating voltage U_e nach UL1077	V	AC 480
Connections	mm ²	2 x 2.5 mm ² solid, 2 x 1.5 mm ² flexible with core, (screw connection Pozidrive size 2)
Tightening torque	Nm	0.8
Approvals		SEV, cUR, UR
Standards		IEC 60947-5-1, UL1077

RCD release signal contact T10		
Utilisation categories compliant to 60947-5-1		AC15 230 V/2A AC15 400V/1 A DC13 250V/0.5A DC13 24V/10mA
Utilisation categories compliant to 60947-4		AC1 400V/6A
Connections	mm ²	1 ... 25
Tightening torque	Nm	2.5
Standards		IEC 60947-5-1

Undervoltage release UA		
Rated operating voltage U_e	VAC/DC	12, 24, 110, 230, 400
Operating range	% U_e	50 ... 110
Power loss of coil when attracted	W/VA	max. 130
Connections C_u	mm ²	1 ... 25
Tightening torque	Nm	2.5
Standards		IEC 60947-1 UL1077

Shunt release AL		
Rated operating voltage U_e	VAC/DC	12, 24, 110, 230, 400
Operating range	% U_e	50 ... 110
Power loss of coil when attracted	W/VA	max. 130
Connections C_u	mm ²	1 ... 25
Tightening torque	Nm	2.5
Standards		IEC 60947-1 UL1077

Let-through energies S500-K

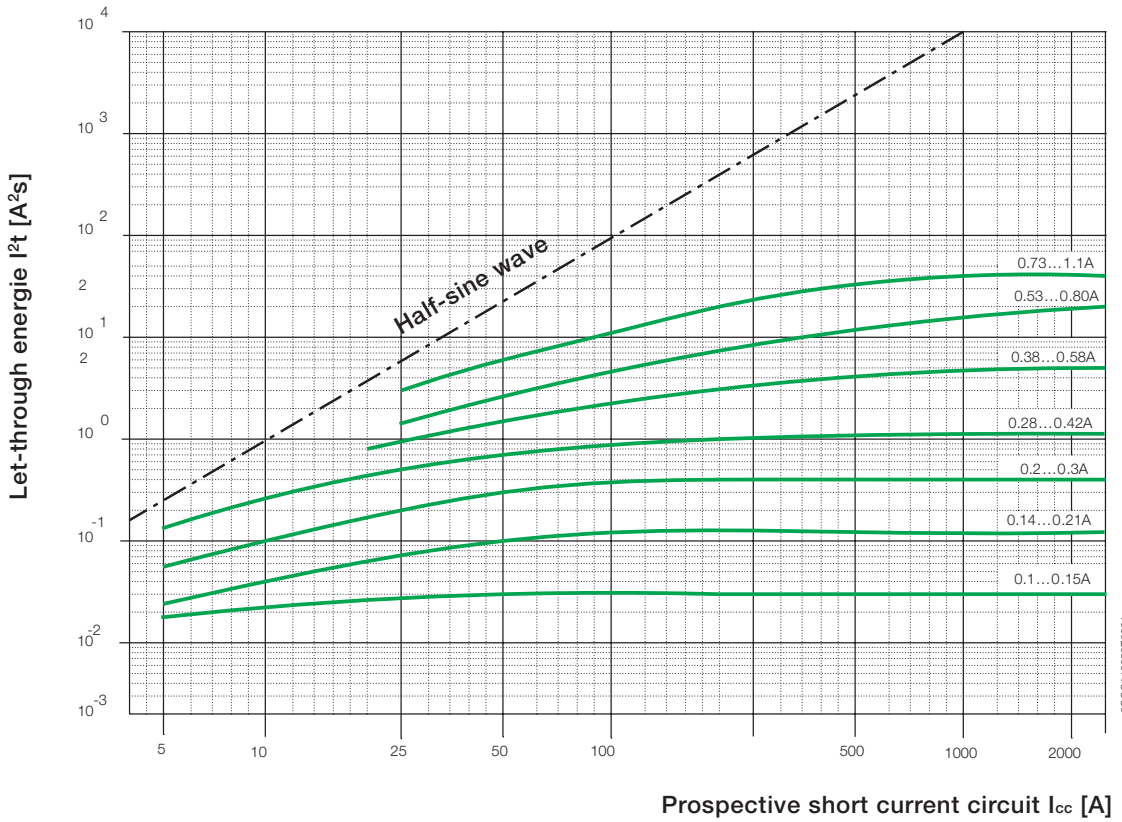

Prospective short current circuit I_{cc} [A]

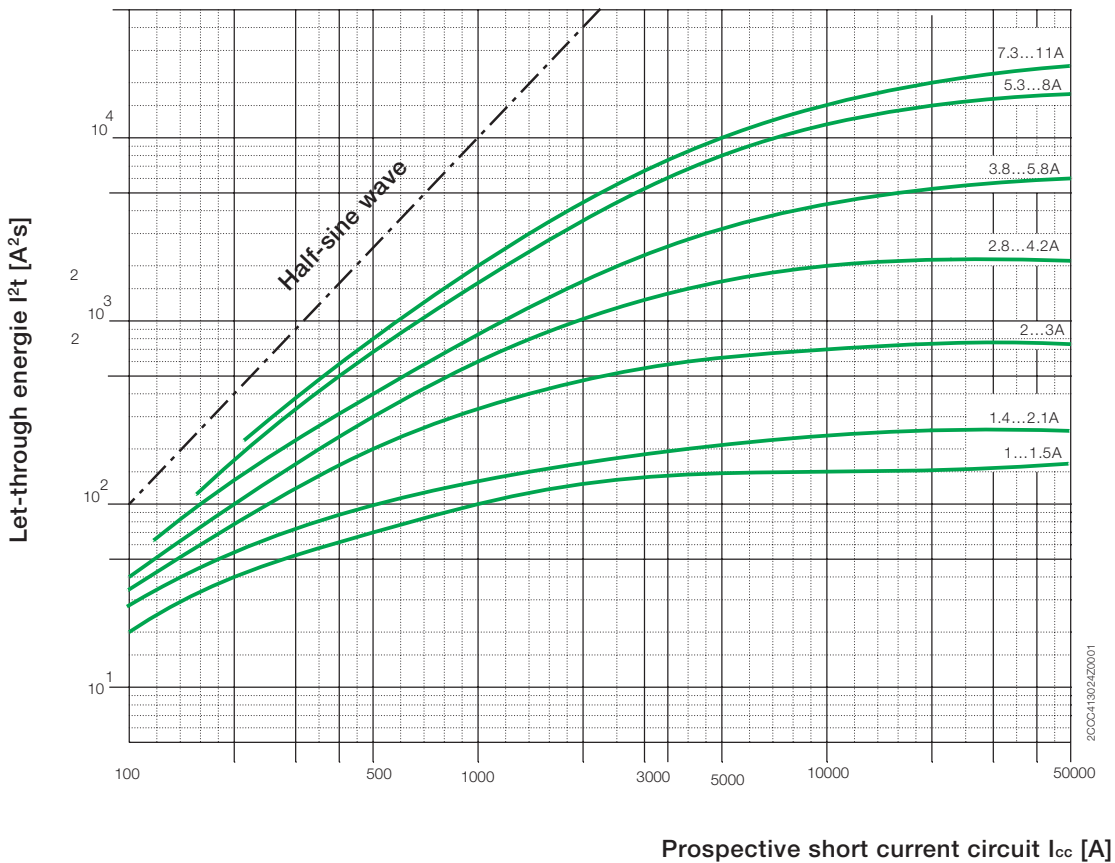

Prospective short current circuit I_{cc} [A]

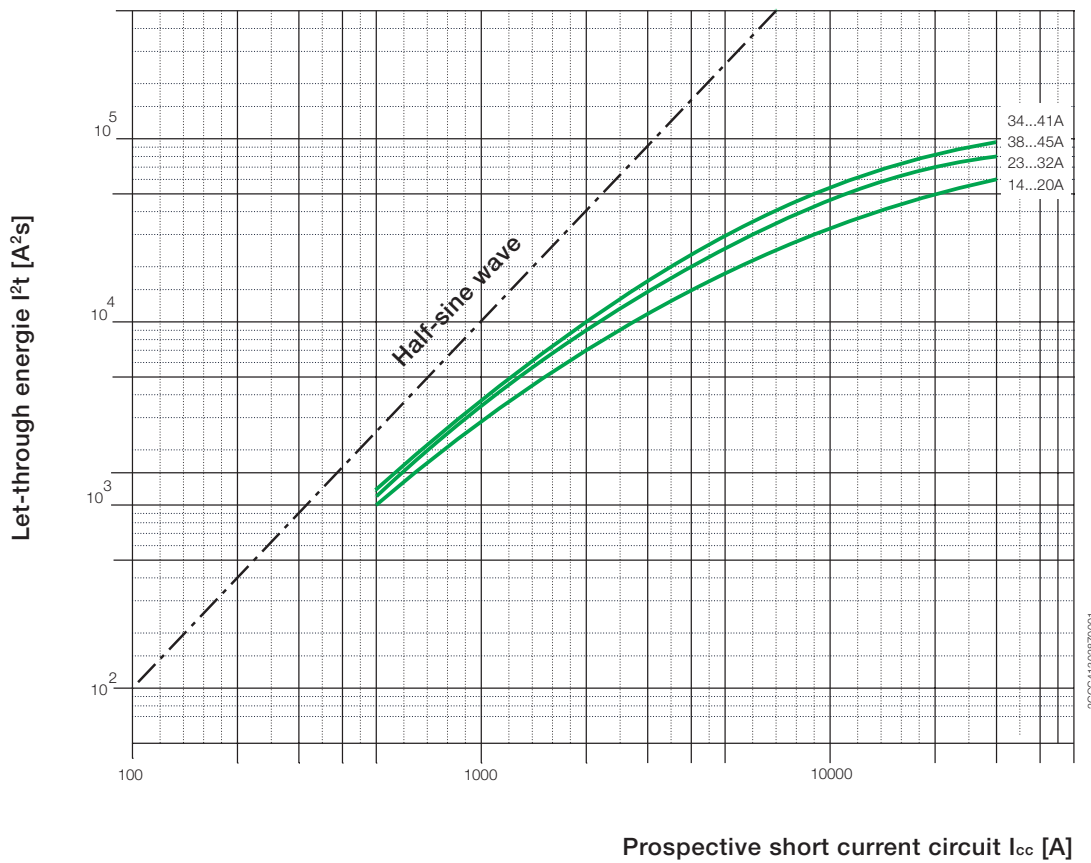
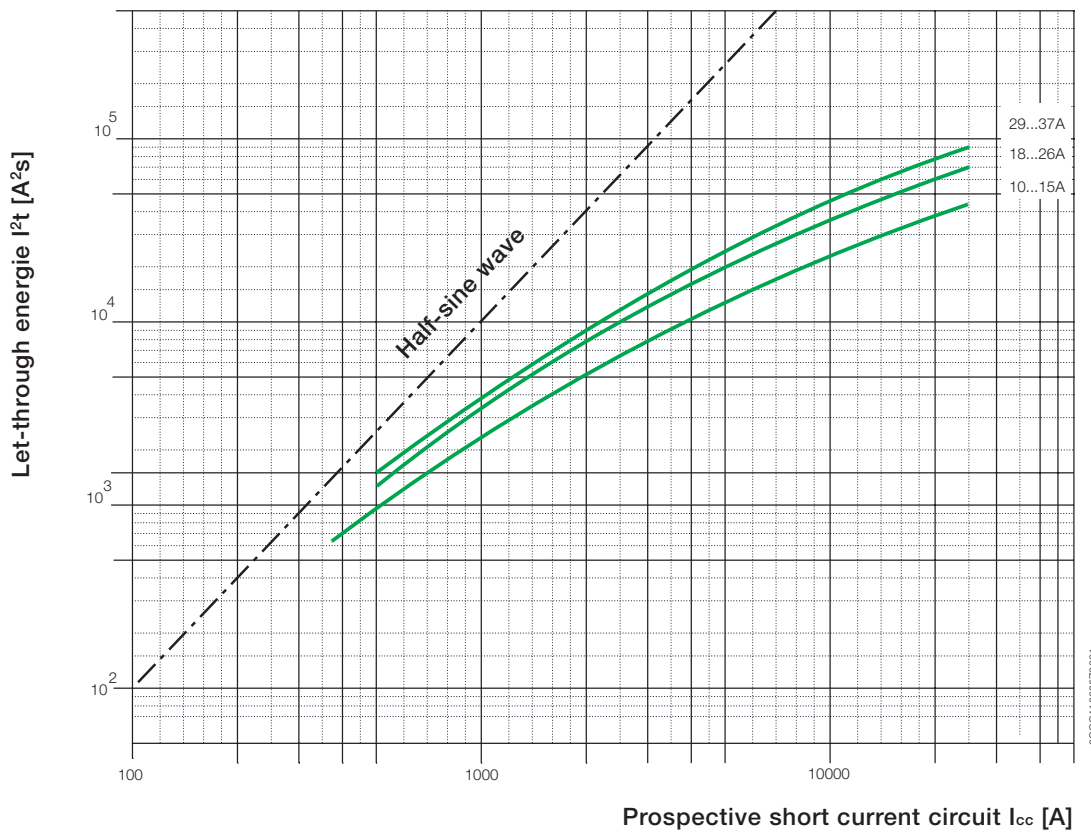

Let-through energies S500HV

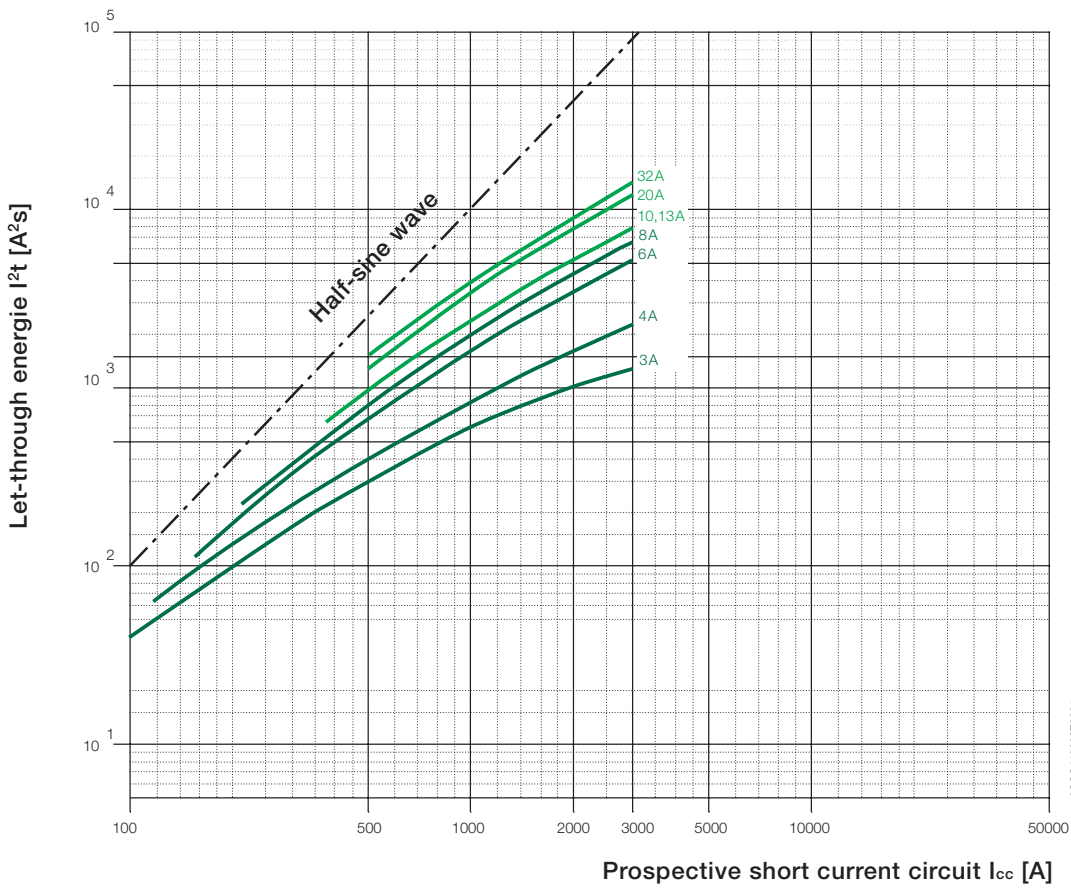
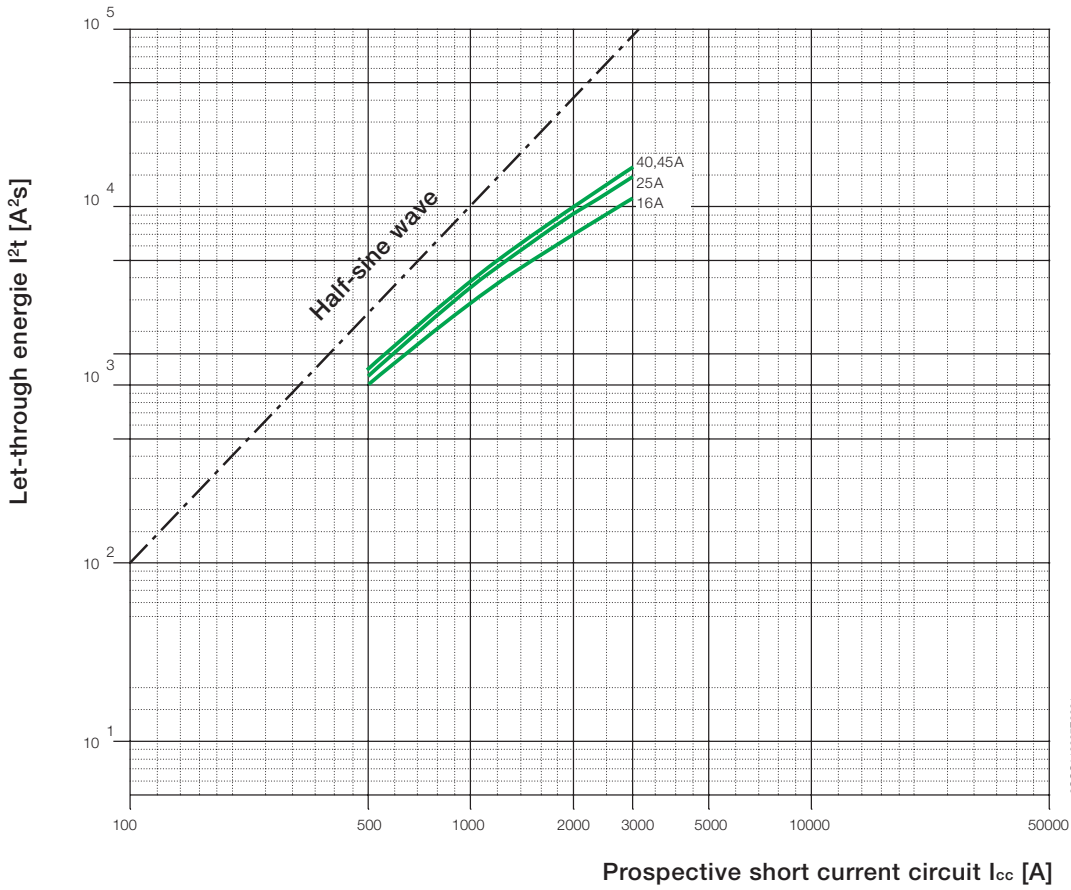

Table of content S500

Pole dimensions

S500-K, X	9/2
S500UC-K, HV	9/2
F500K	9/2

Dimensions of accessories

S500-H11, -H20	9/3
S500-S11, -S20	9/3
...N, ...NA	9/4
...+UA, ...+AL	9/4
Rotary handle	9/4
Pistol grip	9/4
S500-RD +, S500-S51, S500-S52 +, Rotary handle	9/4
Busbar	9/5
Busbar terminal	9/5

Pole dimensions

High performance MCB

S500-K, X

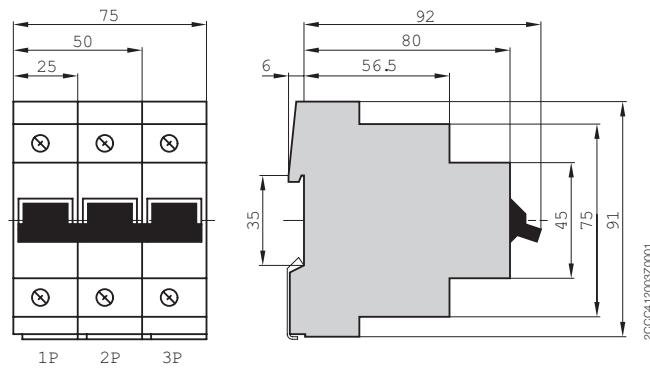

S500UC-K, HV

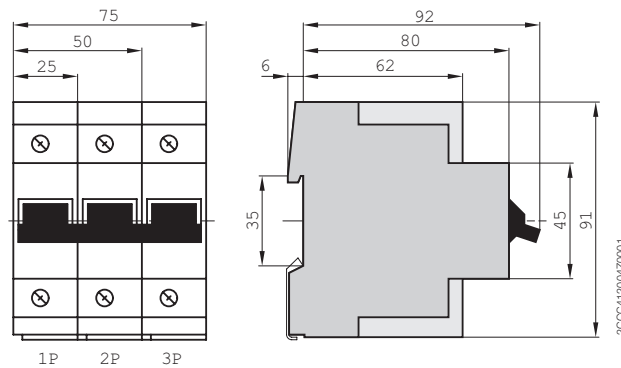

9

F500K

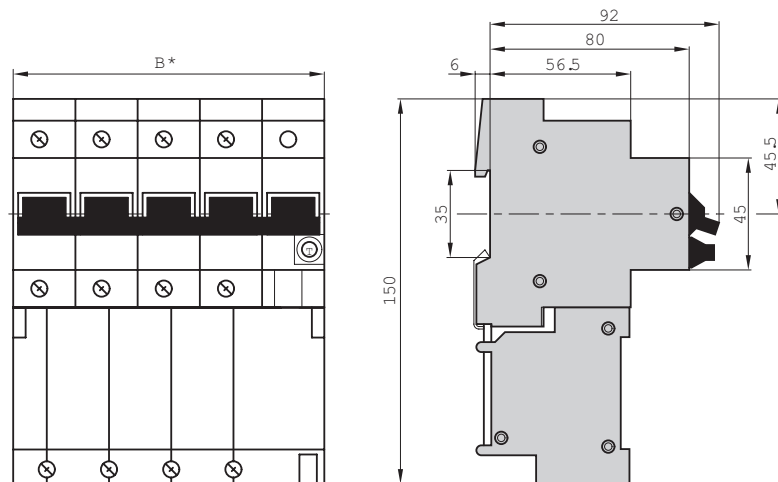

Type designation	*Dim. in mm
F503...	100
F504...	125

Dimensions of accessories

Mounting clearances in mm

Mounting clearances in mm

Dimension	To grounded parts, insulating covers or cable ducts	To bare, live parts where busbar clearance is 10 mm
A	25	80
B	7	100
C	25	25

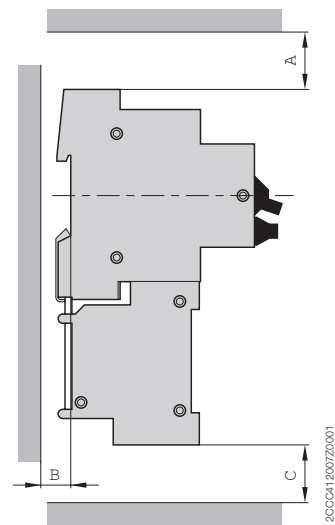
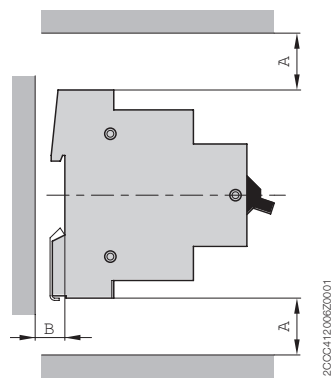

S500-H11
S500-H20

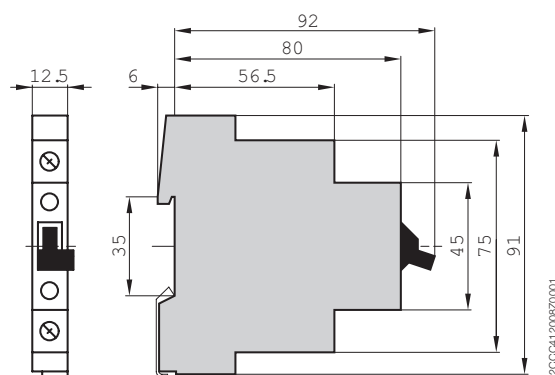

S500-S11
S500-S20

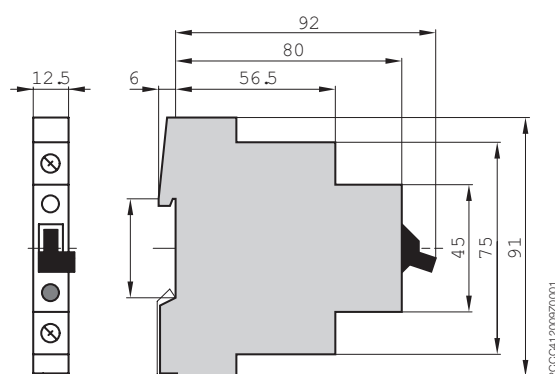

Dimensions of accessories

...N
...NA

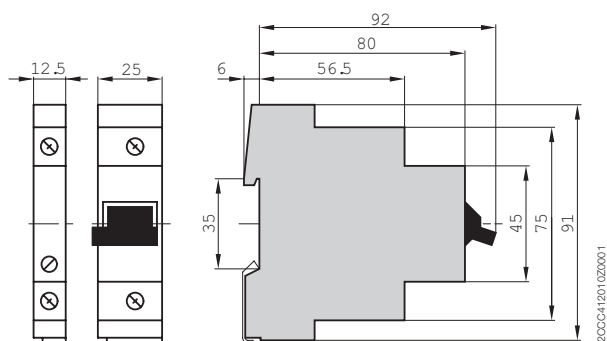

...+UA
...+AL

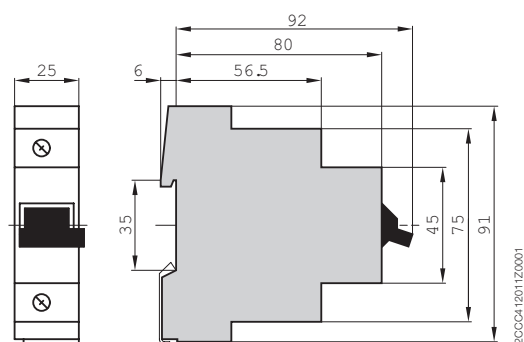

9

Rotary handle

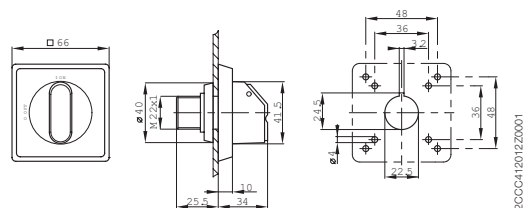

Pistol grip

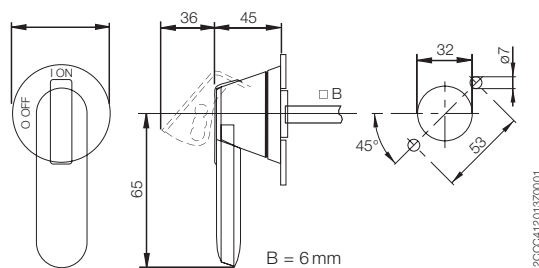

S500-RD +
S500-S51
S500-S52 +
Rotary handle

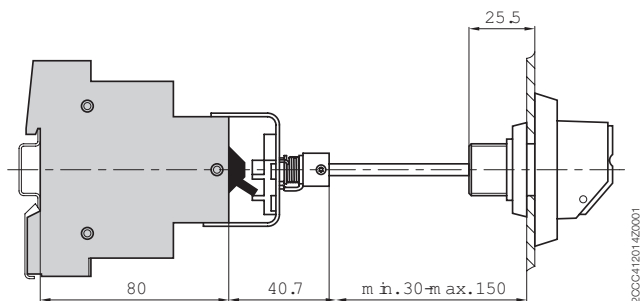

Busbar

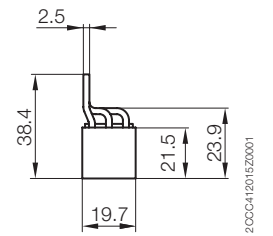
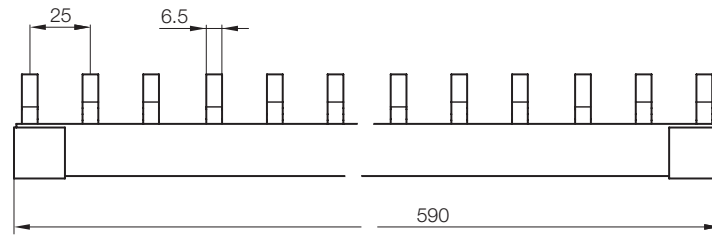

2CCC412015Z001

Busbar terminal

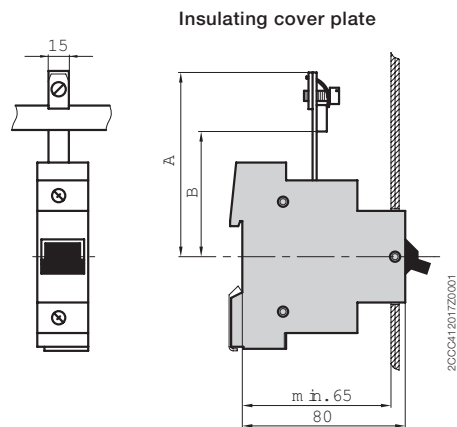
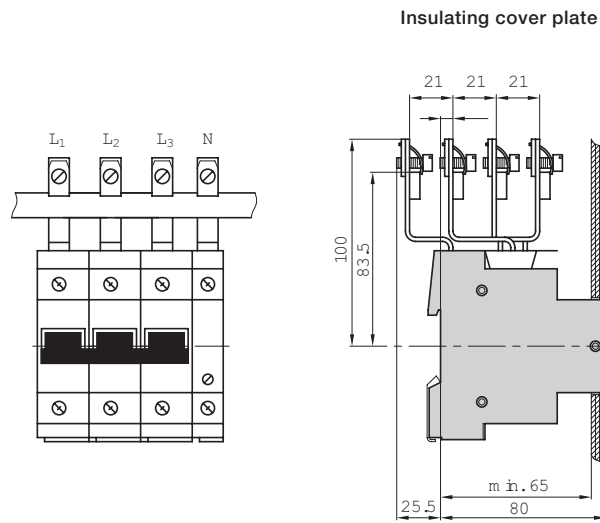







Busbar terminal	Dimension in mm	
	A	B
S500-AK50	91	71.5
S500-AK20	67	47.5

Table of content S500

Approvals and certifications S500	10/2
---	------

Approbationen

	China 	US/ Canada 	Russia  	Marine  
S500 Main devices				
S500-K High performance MCB	■	■	■	
S500UC-K High performance MCB	■	■	■	
S500 accessories				
S500-H11, -H20		■	■	
S500-S11, -S20		■	■	
...+UA Undervoltage release		■	■	
...+AL Shunt release		■	■	

■ devices are approved

□ devices have been submitted for approval or submission planned for device

Contact us

Australia

ABB Australia Pty Limited
601 Blackburn Road
Notting Hill VIC 3168
Australia
Telephone +61 (0) 3 8544 0000
Telefax +61 (0) 3 8544 0001

www.au.abb.com

Belgium

ABB ELECTRO n.v.
Hoge Wei, 27
1930 Zaventem
Belgium
Telephone +32 (0) 27 18 63 11
Telefax +32 (0) 27 18 66 66

www.abb.be

Brasil

ABB Ltda
av. dos Autonomistas, 1496
06020-902-Osasco-SP
Brasil
Telephone +55 (0) 80 00 14 91 11
Telefax +55 (11) 36 88 99 77

www.abb.com.br

Czech Republic

ABB s.r.o.
Herspická 13
61900 Brno
Czech Republic
Telephone +420 54 31 45 50 3
Telefax +420 54 32 43 48 9

www.abb.cz/elsynn

Denmark

ABB AS
Meterbuen 33
2740 Skovlunde
Denmark
Telephone +45 44 50 44 50
Telefax +45 44 50 44 60

www.abb.dk

Finland

ABB OY
Domestic Sales
P.O. Box 182
00381 Helsinki
Finland
Telephone +358 10 22 20 00
Telefax +358 10 22 22 91 3

www.abb.fi

France

ABB Entrelec
Division Commercial France
300 rue des Prés Seigneurs
ZA La Boisse – BP 90145
01124 Montluel Cedex
France
Telephone +33 (0) 825 38 63 55
Telefax +33 (0) 825 87 09 26

www.abb.fr

ABB Switzerland Ltd.

Low Voltage Products
Brown Boveri Platz 3
CH-5400 Baden
Telefon +41 (0) 58 586 00 00
Telefax +41 (0) 58 586 06 01

www.abb.ch

Great Britain

ABB Limited
Tower Court
Foleshill Enterprise Park
Courtaulds Way
Coventry
CV6 5NX
England
Telephone +44 (0) 24 76 36 85 00
Telefax +44 (0) 24 76 36 44 99

www.abb.com/lowvoltage

India

ABB Limited
Plot Nos 5 & 6, 2nd Phase
Peenya Industrial Area
Bangalore 560 058
India
Telephone +91 80 2294 9150
Telefax +91 80 2294 9148

www.abb.co.in

Ireland

Asea Brown Boveri Ltd.
Belgrad Road, Tallaght
Dublin 24
Ireland
Telephone +35 31 40 57 30 0
Telefax +35 31 40 57 33 2

www.abb.com/lowvoltage

Netherland

ABB b.v.
Automation Products
Marten Meesweg 5
3068 AV Rotterdam
Postbus 301
3000 AH Rotterdam
Netherland
Telephone +31 (0) 10 40 78 91 1
Telefax +31 (0) 10 40 78 09 0

www.abb.nl

Norway

ABB AS Automation Technology
Products Division
P.O. Box 797 Brakeroya
3002 Drammen
Norway
Telephone +47 32 24 80 00
Telefax +47 32 24 79 34

www.abb.no

Poland

ABB Sp. z o.o.
Automation Products
ul. Zeganska 1
04-713 Warszawa
Poland
Telephone +48 22 51 64 441
Telefax +48 22 51 64 444

www.abb.pl

P.R. China

ABB (China) Ltd
Universal Plaza, 10 Jiuxianqiao Lu
Chaoyang District
100016 Beijing
P.R. China
Telephone +86 10 8456 6688
Telefax +86 10 8456 9907

www.abb.com.cn

Russian Federation

ABB Industrial & Building Systems Ltd.
30/1, bld. 2, Obrucheva St.
117861 Moscow
Russia
Tel.: +7 495 960 2200
Fax: +7 495 960 2220

www.abb.ru/ibs

Singapore

ABB Pte Ltd
2 Ayer Rajah Crescent
Singapore 139935
Telephone +65 6776 5711
Telefax +65 6778 0222

www.abb.com.sg

Spain

ABB Automation Products, S.A.
c/Torrent de l'Olla 220
08012 Barcelona
Spain
Telephone +34 93 48 42 21
Telefax +34 93 48 42 190

www.abb.es

Sweden

ABB Automation
Technologies Cewe Control
Muturgråd 20
72161 Västerås
Sweden
Telephone +46 (0) 21 32 07 00
Telefax +46 (0) 21 12 60 01

www.abb.se

Ukraine

ABB Ltd, Ukraine
Automation Products Low Voltage
4, Ivana Lepse Blvd.
Kiev 67, 03680
Ukraine
Telephone +380 44 495 22 11
Telefax +380 44 495 22 10

www.abb.ua

United Arab Emirates

ABB Industries (L.L.C.)
P.O. Box 11070
Dubai
United Arab Emirates
Telephone +971 4 314 7500
Telefax +971 4 340 1771

www.mena.abb.com

In consideration of modification to standards and materials, the characteristics and overall dimensions indicated in this catalogue may be binding only following confirmation by ABB.