

iDim Sense DALI Sensor

The iDim Sense is a luminaire-based DALI sensor. It contains:

- a light sensor (for Constant Light function);
- a passive infra-red (PIR) movement detector;
- an infra-red receiver (for remote control)

The manual mode selector allows the user to easily select one of the 6 out-of-box application modes.

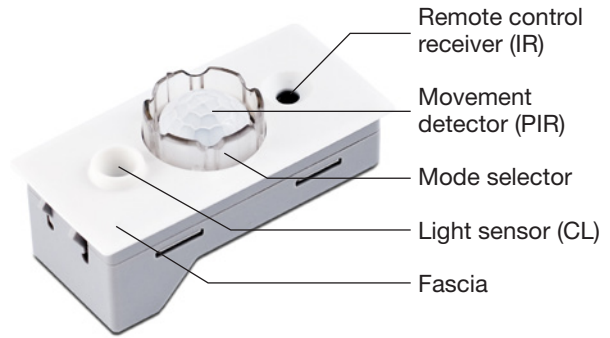

Key Features

- PIR, Constant Light and Infrared control
- Easy to select application modes
- Clip-on fascia in different colours
- Clip-on PIR Restrictor
- Mode selector with LED feedback

Installation Notes

- Multiple mounting options:
 1. Mount from outside luminaire: "Click fit"
 2. Mount from inside luminaire: "Bracket fit"
 3. Combined with a louvre adapter: "Adapter fit"
- Isolate the mains supply before installation
- Cabling must be 230 VAC mains rated when used outside luminaire. Use Alpha 1174C or 6642

Recommended Mounting Location

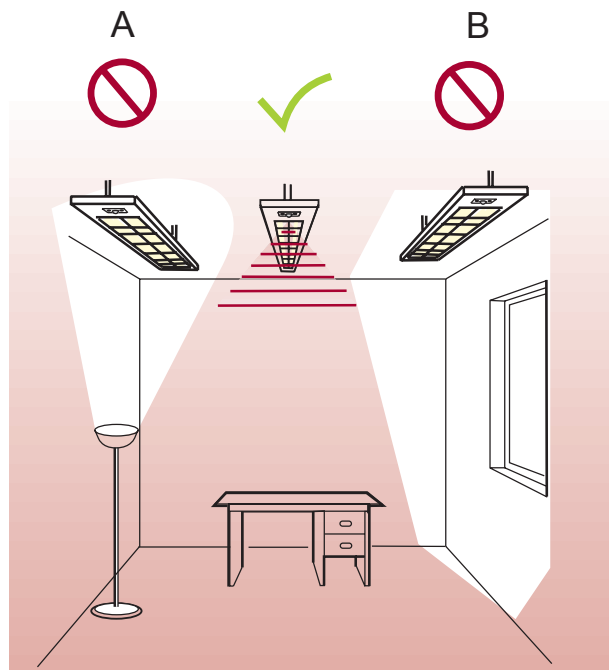

1. Do not mount sensor in direct line of artificial light sources e.g. lamps, uplighters.
2. Do not mount sensor in direct sunlight

PIR Coverage

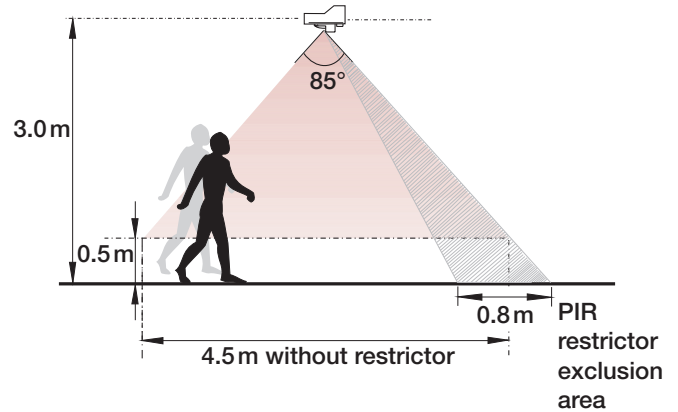

Constant Light Coverage

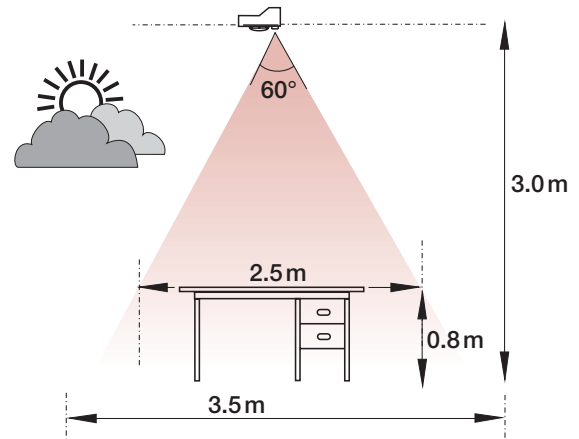

Technical Data

Connections

DALI:	Wire size: 0.5 mm ² - 1.5 mm ² Solid, flexible or stranded Strip length: 9 mm
iDim Solo:	RJ Style 4P4C crossover (max. 3 m) Accessory cable available
Power cable rating:	All cables must be mains rated

Power

DALI Consumption:	10 mA
--------------------------	-------

Sensors

Light sensor:	For Constant Light functions
Presence detector:	PIR: Passive infra-red presence detector
Infra-red receiver:	For remote control commands

Remote Control Functions

Infrared remote control:	Modify preset light levels (Constant light or Fixed light); Scene store and recall; Activate special test functions
---------------------------------	---

Mechanical Data

Dimensions (L x W x D):	55 x 25 x 20 mm (without fascia) 58 x 28.5 x 21.4 mm (with fascia)
--------------------------------	---

Recommended luminaire thickness:	0.6 mm to 2.4 mm
Material (casing):	Fire-retardant polycarbonate
Colour:	iDim Sense: Grey (RAL 9006) iDim Fascia: White (RAL 9016) or Grey (RAL 9006)

IP rating:	IP 30
Weight:	15 g

Operating Conditions

Ambient temperature:	10°C to 50°C
Relative humidity:	Max 90%, non-condensing
Storage temperature:	-25°C to 75°C
Lux level:	5 to 5000 lx

Conformity and Standards

EMC: Emission:	EN 55 015
Immunity:	EN 61 547
Safety:	EN 61 347-2-11
Isolation:	Double isolated
Environment:	Complies with WEEE and RoHS directives

Typical connection: to iDim Solo

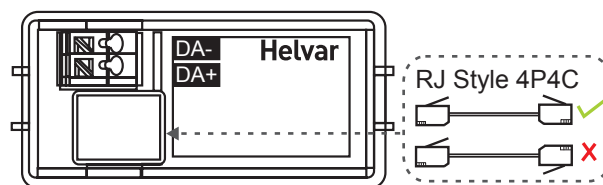

Dimensions (mm)

iDim Sense with fascia

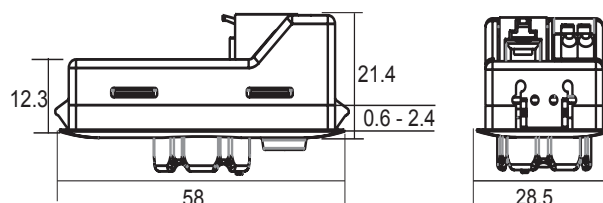

iDim Sense without fascia

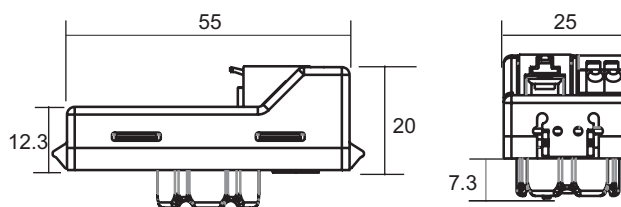

Typical mounting: with fascia

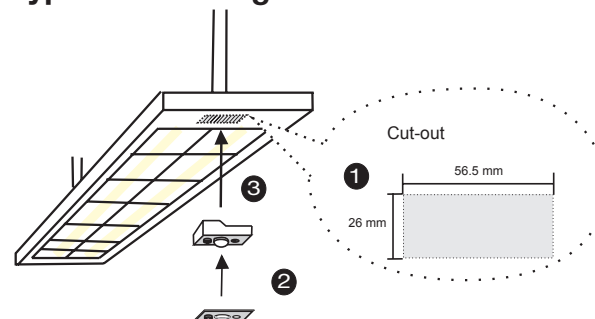

Alternative mounting: without fascia

