

ENGINEERING  
TOMORROW

*Danfoss*

Electrical Heating

# Indoor Cable Floor Heating Systems

## Application manual





# Let Danfoss do the work

Danfoss Group is Denmark's largest industrial group. It is one of the world's leading companies within heating, cooling and air-conditioning. The Danfoss Group has more than 23000 employees and serves customers in more than 100 countries.

Danfoss is Europe's leading brand of electrical cable heating systems and electric pipe heating systems with over 70 years of experience. The production of heating cables takes place in France and Poland while the head office is situated in Denmark.

## The value of experience

We have installed literally millions of systems across the globe, in every conceivable setting. This experience means that we can offer you practical advice about precisely which components you need to get the best results at the lowest cost.

## Indoor Cable Floor Heating Systems

This design guide presents Danfoss's recommendations for design and installation of cable floor heating systems for indoor application.

It provides guidance for heating cable positioning, electrical data and system configurations.

Following Danfoss's recommendations will ensure energy efficient, reliable and maintenance free solution for constant wattage heating cables with 20 year warranty.

## Our quality management system **certifications and compliances**

✓ ISO 9001

✓ TS 16949

✓ ISO 14001

Along with full compliance with EU directives and product approvals

# Index

<b>1. Danfoss electrical heating systems</b>	<b>4</b>
<b>2. Application Briefing</b>	<b>5</b>
2.1 General information	5
<b>3. Product overview</b>	<b>6</b>
3.1. Cables	6
3.2 Mats	6
3.3 Thermostats	7
<b>4. Heating systems in floor constructions</b>	<b>9</b>
4.1. Comfort Floor Heating	9
4.2. Total (Direct) floor heating	13
4.3. Accumulating heating via electrical floor heating system	18
<b>5. Electrical heating system floor constructions</b>	<b>21</b>
5.1. Cable heating in thick concrete floor construction	21
5.2. Electrical heating system in thin floor construction	25
5.3. Heating in wooden floors	30
<b>Appendixes</b>	<b>48</b>
A.1. C-C distance and corresponding output W/m <sup>2</sup>	48
A.2. Fitting	49
A.3. Floor sensor installation	50
A.4. General installation guide	51
<b>6. Cases</b>	<b>52</b>

# 1. Danfoss electrical heating systems

This document includes all necessary information about Danfoss cable heating systems which can be helpful in your decision making during its design, installation and operation. The distinctive feature of Danfoss's profile is production of cable heating systems.

Danfoss takes a leading position as a founder and an innovator in the field of electrical heating cable systems for indoor and outdoor installation.

Danfoss is the Europe's largest supplier of electrical floor heating. Our business philosophy is based on marketing electrical heating solutions that clearly stand out as the following:

- Increasing comfort in everyday life;
- Greater reliability;
- Better design;
- Improved operating costs.

Danfoss develops, manufactures and sells heating cable systems for the following main applications:

- Total electrical floor heating;
- Comfort electrical floor heating;
- Ice and snow melting on ground – roads, pavements / pedestrian walkways, bridges etc.;
- Ice protection and snow melting for roofs and gutters;
- Protection against freezing and temperature maintenance of pipelines, tanks and other industrial applications;
- Heating of play-fields with natural or artificial grass, soil in greenhouses, etc.;
- Heating of agricultural premises;
- Frost protection of foundations and floors in cold stores and ice stadiums; as well as many other heating solutions.

## Complete systems

Danfoss is the only global company in the industry that develops, produces and markets complete systems containing both heating cables and thermostats in the global market. Consequently, there is a full harmony between the single components that make up our heating systems, which means high performance, optimum reliability and usability and as a result low energy consumption.

## Integrated solutions

For almost 75 years Danfoss has been producing a wide range of proven tested heating cable solutions – everything from thin heating mat systems mainly intended for renovation purposes, to complete heating systems for room heating in private dwellings as well as offices and industrial buildings. Danfoss also supplies ice and snow melting solutions. Our cables and thermostats keep traffic areas, loading ramps and roof constructions safe in cold areas throughout the world. We provide anti-frost systems for pipes and roof gutters and we heat the soil in greenhouses, or even under football fields.

## Intelligent heating systems

The main Danfoss product is a complete heating system (heating cable or mat, thermostat and accessories).

Energy efficiency and its intelligent use is built in Danfoss thermostats since the 90's. Saving up to 30% of electrical bill, compared with an advanced electronic thermostat without a timer, Danfoss intelligent thermostats are world leading example to follow in the area of intelligent electrical floor heating.

## High quality heating elements manufactured in EU

Danfoss heating element is a screened twin or single conductor made with different specific outputs and insulation options. Danfoss heating elements are produced in over thirty different types allowing application of the product that suits best to your specific requirements.

Thin heating mats designed for installation under the tiled floor are most in demand. Danfoss mats consist of a thin cable fixed on a composite or glass fiber self-adhesive mesh, which makes mats easy to install and a logical choice for thin floors. When laying heating mats the floor level is virtually the same since installation can be performed with a standard thickness of the tile glue.

System installation and calculation of desired output shall be performed based on specific conditions of premises (application). To ensure proper installation and operation of each Danfoss system it is accompanied by multilingual detailed instructions. In addition, most of heating cables and mats have 20 year warranty.

ECtemp Smart, the latest solution, that is worth special attention – it embodies the essence of Danfoss commitment to improve user comfort, interaction with intelligent electronic devices, Nordic design and energy efficiency. ECtemp Smart thermostat with:

- user-friendly interface via APP and Wi-Fi control,
- touch screen,
- intelligent timer functions with an intuitive user-friendly interface which is designed specifically to meet the needs of modern users,
- extended warranty period – 5 years.

## Reliable choice.

Danfoss is the world leader in the production of electrical heating cable systems. Presented in the global market for almost 75 years and available in more than 100 countries on five continents. You can safely recommend products to your clients as far as Danfoss trademark has occupied a leading position on the world market and has been a trusted partner for decades.



## 2. Application Briefing

### 2.1 General information

#### Optimal comfort

All heat moves upwards! This simple fact explains why a floor heating system provides more comfortable heat, than the alternative radiator system. The radiator system provides convective air movement up to head height and ceiling, only to travel downwards and return as a cold draft around ones feet.

Danfoss's floor heating system, on the other hand, provides pleasant heat for ones feet, body and head.

As it produces only a very gentle upward air movement the amount of travelling dust particles is reduced considerably making the system a great asset to people suffering from allergies or asthma. It also minimizes presence of moisture at floor level.

#### Minimal energy consumption

Thanks to heat distribution from the floor and precise temperature control system with a EFET or ECtemp thermostat, the average room temperature can be reduced by 1-2 °C compared with traditional radiator heating, without influencing the thermal comfort or even improving it. This enables reducing energy losses, from a dwelling, by 10-20%, which is both economically and environmentally beneficial.

#### Flexible system

Danfoss's floor heating system ensures comfortable room temperatures, be it at home, at the office, in a workshop, sports hall or virtually anywhere where comfortable heat is required. Equally important is the fact that Danfoss's floor heating system can be installed in all floor types whether they are new concrete or wooden floors or renovated floors.

#### Invisible heat source

Danfoss's floor heating system is invisible. As the system is hidden under the floor it gives exciting new possibilities for furnishing and interior design and the problem of space-consuming and unattractive radiators (or heaters) no longer has to be considered.

#### Ease of Installation

Danfoss electrical underfloor heating provided as a system, be it a heating mat, cable with installation accessories or a thermostat with easy setup feature, quick and effortless installation.

#### High durability, no maintenance

Danfoss's floor heating system has a long life. Practically speaking Danfoss's heating cables and mats last as long as the house where they are installed and no maintenance is required!

#### Quick and Precise Response Time

Electrical floor heating system has a quick response time. Along with EFET and ECtemp intelligent thermostats it also offers precise increase and regulation of room temperature comparing to water based floor heating systems. System's responsiveness to temperature changes and user adjustments is also better.

#### 20-year Danfoss Warranty™ and Full Service warranty

20-year Danfoss Warranty™ is valid for most of Danfoss heating mats and heating cables. Danfoss support Full service warranty for cables and mats installed indoor for floor heating – included costs for installation and floor materials such as damage to bricklaying and tiles. Full Service 20-year warranty implies that when there is a warranty case Danfoss undertakes a responsibility to correct the defect free of charge or offer product replacement during the warranty period. In addition, Danfoss covers all costs associated with the replacement of any heating system element and floor cover restoration costs.



## 3. Product overview

### 3.1. Cables

Electrical floor heating system consists of two main components:

- Heating element (cable, thin heating mat, or heating element for laminate floors, etc.);
- Thermostat with air or/and floor temperature sensors.

Heating cables are usually installed in thick/concrete floor constructions. The main feature of a thin heating mat is its low thickness. This gives the possibility for it to be installed in a thin layer of tile glue avoiding considerable increase of floor level.

Danfoss heating cable (e.g. ECflex) is designed for installation in thick concrete floor constructions. Usual thickness of top/finish floor layer is at least 3 cm. Heating cables used in floor constructions are serial resistive cables, preferably twin conductor, but also a limited range of single conductor cable is available. Cables are manufactured as ready-to-install heating elements with specific length (i.e. 7, 10, 15, up to approx. 410 m), with a power supply cable (cold tail) and hermitically closed connections (muffs or end terminations).

Output of heating cables for installation in floor constructions is limited to 20 W/m and Danfoss cables are available with 10, 18 and 20 W/m for 230 and 400 V. Most Danfoss cables are manufactured and approved in accordance with the latest version of IEC 60800:2009, with mechanical strength class M2 (for rough concrete constructions). The main type of Danfoss heating cables for installation in the floor construction is ECflex.

Internal and external design of modern ECflex cable is shown in the figures below.

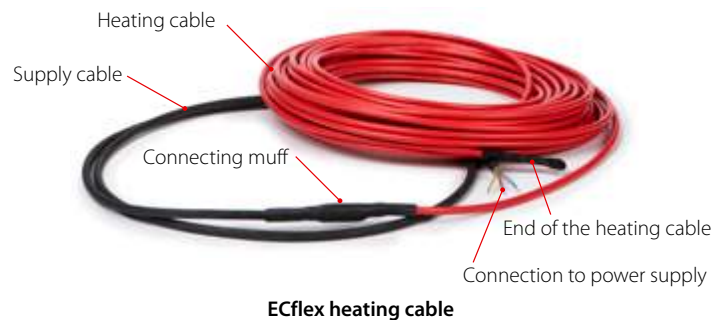
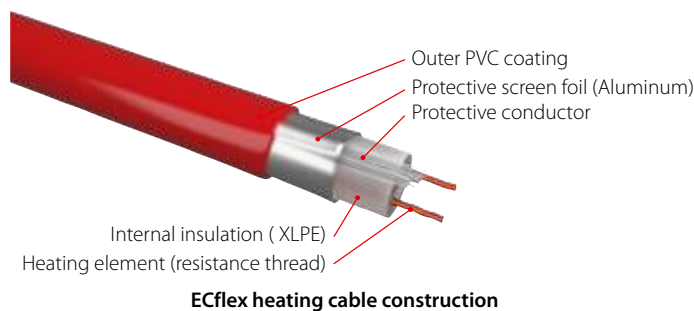

### 3.2 Mats

The thin heating mat is designed for installation in a thin tile glue layer adhesive, self-leveling mixture or alike. The standard minimum thickness of the floor layer is 5-8 mm while the thickness of Danfoss mats is 3-4,5 mm. It allows minimizing the floor level increase. Danfoss thin heating mats consist of a thin cable fixed on self-adhesive glass-fiber mesh usually

of 50 cm width. Thin heating cables are serial twin or single conductor resistive cables. Thin heating mats are manufactured as ready-made heating sections with a specific area (i.e. 0,5, 1, 1,5 ... 12 m<sup>2</sup>) including a power supply cable (cold tail) and hermetically sealed connections.

Thin heating mats are available with various outputs, for example: 70 W/m<sup>2</sup>, 100 W/m<sup>2</sup>, 150 W/m<sup>2</sup> and 200 W/m<sup>2</sup>. Danfoss thin heating mats comply with IEC 60335-1 & IEC 60335-2-96.

The most commonly used Danfoss twin conductor heating mats for installation in the floor construction are ECmat and ECcomfort.

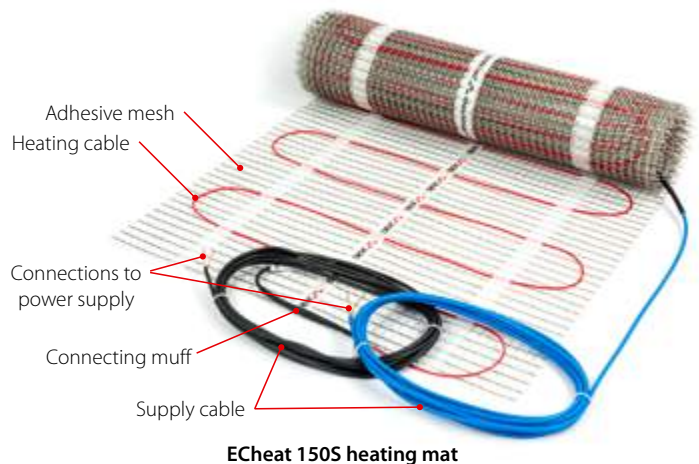
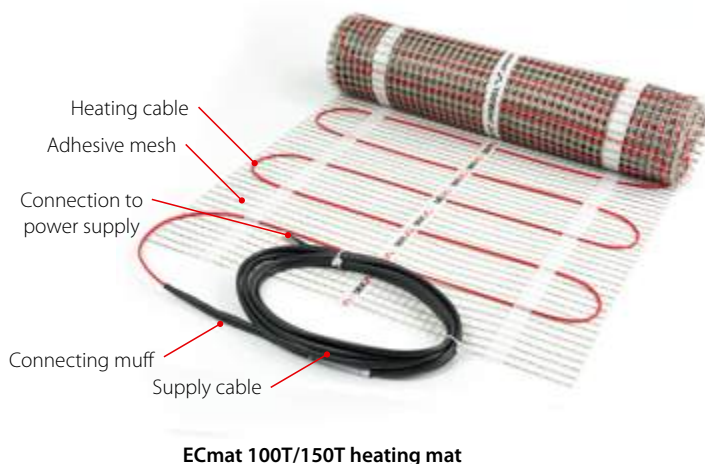

Center-to-center distance between mat's cable lines is usually 7,5 cm. It allows even distribution of heat on the floor surface avoiding cold zones between the cable lines.

The modern thin twin conductor ECmat and single conductor EHeat are shown above.

### 3.3 Thermostats

Danfoss offers specialized thermostats for electrical floor heating systems. All thermostats are electronic devices allowing precise control of the floor surface or air temperatures. In general three types of thermostats are available:

- for air/room temperature control and limitation of floor temperatures – with room sensor and floor sensor;
- for floor temperature control – with floor sensor only;
- for air/room temperature control – with room sensor only.

Danfoss offers thermostats that are:

- Intelligent and PWM regulated (Pulse Width Modulation);
- Simple (hysteresis regulated).

Intelligent thermostats provide state-of-the-art wireless control system for control of heating and electrical units in private houses. Some thermostats are fitted with Wi-Fi allowing remote control of heating systems via mobile application.

Simple thermostats are electronic control units with or without display allowing setting the heating system type, adjustment of control parameters and timer mode.

Danfoss heating cables and thin heating mats mentioned above are the most used floor heating elements. Danfoss also produces other floor heating elements, i.e. ECdry and Reflect insulation plates for heating constructions with wooden surface (laminated, multi-layer boards,

parquet, etc.) or/and on wooden subfloors. ECdry has 55 and 100 W/m<sup>2</sup> outputs.

For further information please refer to the Danfoss Product Catalogue and data sheets.

**ECtemp Smart** is the Danfoss's latest solution and a further development of, the very well known ECtemp Touch with Wi-Fi control via mobile application, unique Nordic design and advanced user experience, with application that enables up to 10 different users to control electrical heating systems from anywhere in the world using a smartphone or a tablet.

ECtemp Smart is an intuitive programmable intelligent timer thermostat used for controlling electrical floor heating elements. The thermostat is designed for flush-mount installation into a standard wall installation box, or on wall with a special on-wall box. Due to the special 2-part construction it fits a wide range of frames and sensors.

ECtemp Smart builds further on energy saving functions introduced earlier in ECtemp Touch, like:

- fast and intuitive setup using the built-in wizard;
- energy-saving program – including optimum start/end control ensuring the desired temperature at the correct time and thereby reducing heating costs;
- open window function;
- very precise regulation of user set room temperature by means of a specially developed PWM (Pulse Width Modulation) regulation, including optimal change from comfort to economy mode.



Danfoss Link CC

**Danfoss Link CC** (Central Controller) is the central brain in the Danfoss Link system which includes several wireless Danfoss Link devices installed inside the building.

Several functions, i.e. room control, intelligent timer, modes for the whole house – "Away", "Comfort", "Frost Protection", are integrated into the unit to reduce energy consumption when using electrical floor heating system.

The idea of the Danfoss Link System is to provide wireless connection of your heating system and to control it from one central point. The Danfoss Link CC communicates wirelessly with all other Danfoss Link units of the installation. A single Danfoss Link CC can control up to 30 rooms and allows connection up to 50 units and specially developed to satisfy the needs of any family house: it can be also used for apartments, and multifamily buildings.

Danfoss Link is fitted with Danfoss Link™ App, and the latest version provides the possibility of Wi-Fi control by mobile application, anywhere in the world.



ECtemp Smart



**ECtemp Touch**

**ECtemp Touch** is a thermostat fitted with a display and an intelligent timer. It is designed for flush-mount installation into a standard wall installation box. It operates with two sensors – floor wire and built-in room sensor. It allows control setting for one of 3 heating systems: with wire floor temperature sensor, with built-in room sensor or with built-in room sensor and wire floor sensor for limitation of floor temperature. The touch screen menu and intuitive user friendly interface allow easy use and quick service. The thermostat has four original colors – polar white, pure white, ivory and black. It can be installed in complex frames of different manufacturers.

ECtemp Touch is fast and intuitive to setup using the built-in wizard. It has an energy saving program – including optimum start/end control ensuring the desired temperature at the correct time and thereby reducing heating costs.



**EFET 530**

**EFET 53x** series thermostats are designed for flush-mount installation into a standard wall installation box. Three models are available:

- EFET 530 with wire temperature sensor;
- EFET 531 with built-in room sensor;
- EFET 532 with built-in room sensor and wire floor sensor for limitation of floor temperature.



**EFET 130**

**EFET 13x** series thermostats are designed for mounting directly on the wall. Following models are available:

- EFET 130 with wire temperature sensor;
- EFET 132 with built-in room sensor and wire floor sensor for limitation of floor temperature.



**EFET 330**

**EFET 330** (5...45°C) – is an electronic thermostat to be installed in electric cabinets with DIN rail attachment. The set includes wire temperature sensor. To control room temperature an external air sensor is required.

Danfoss offers over 20 different types of thermostats. The product range includes easy to operate (by APP) intelligent Wi-Fi control thermostats to specifically designed digital, thermostats with moisture sensors for ice and snow melting on ground as well as ice protection for roofs and gutters (refer to Ice & Snow melting Application Sheet). Danfoss Link and ECtemp Smart system is equipped with wireless functions and Wi-Fi control of heating systems and indoor electrical equipment.

Danfoss provides a unique solution – that is “top quality intelligent heating system”, giving consumers the highest level of comfort and safety! The intelligent component of these systems is the EFET or ECtemp electronic thermostat which is available in several options, i.e. for total heating or comfort floor heating.

More information about Danfoss thermostats you can find further in this document and in the Danfoss Product Catalogue and data sheets.



## 4. Heating systems in floor constructions

Electrical floor heating systems for indoor heating can be divided into 3 main heating categories (types):

- Comfort floor heating;
- Total or Direct heating;
- Accumulating heating.

This will be described in details on the following pages.

### 4.1. Comfort Floor Heating

#### 4.1.1. About the system

Comfort Floor Heating or “Warm Floor” system provides heated floor surface, in any rooms, and especially used for bathrooms and kitchens. Comfort floor heating can be used in any room fitted with another heating system to provide required air temperature, for example water based radiators on the walls. Warm Floor/ Comfort heating installed in such premises only maintains constant floor temperature at all times, regardless of the heating season. As an additional benefit the Comfort heating increases air temperature in the room, and due to large heated floor surface will allow compensation of inadequate heating during extremely cold winter days or in case of lack of heat regulation in rooms which are not fitted with a modern thermostat controlled room heating systems. Comfort floor heating system is controlled by a thermostat with a floor sensor (usually wire sensor). The heating element is activated by a thermostat based on the floor temperature set by the user.

A comfortable floor temperature has been evaluated many times, for example, described in standard ISO/TS 13732-2. The maximum long term comfort floor surface temperature is defined at the level of 29,5 °C. Additionally: sedentary people needed extra 1-2 °C. For floors in wet rooms maximum temperature can reach 31 °C. These maximum temperature values can be used for calculation and selection of installed outputs (in [W/m<sup>2</sup>]) of comfort floor heating systems. Different types of floor surfaces need different comfort floor temperatures, e.g. wooden floor surface has an optimal comfort temperature of approximately 26 °C, carpet – approximately 24 °C. But it is impossible to predict type of floor surfaces during life time of floor construction, as well as that comfort

temperature is perceived differently by different individuals. It is advised to use maximum comfort floor temperature level to satisfy all possible options, but often a floor temperature few degrees above the current room temperature will already satisfy the needs of most users. It is important that most of wooden floor surfaces have limitation of max. temperature at the level of 27 °C (for more details concerning maximum allowed temperatures of the floor surface please refer to a manufacturer of wooden floor materials).

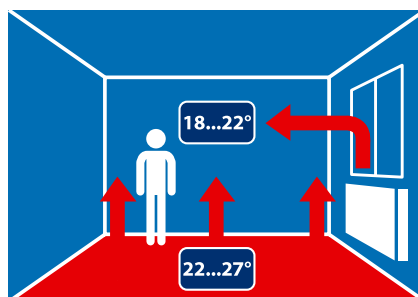

#### EXAMPLE:

The optimal required output (in [W/m<sup>2</sup>]) for comfort floor heating system, can be evaluated by a simple calculation. Assuming that the room temperature is 20 °C (supported by another heating system during the heating season) and the floor surface needs to reach up to 29 °C. The floor temperature must be increased as follows: 29 - 20 = 9 °C. Information about the installed output (in [W/m<sup>2</sup>]) needed to heat up 1 m<sup>2</sup> of floor surface to 1 °C can be found in physic books and standards (e.g. DS/EN 1264. Heat exchange coefficient, usually named alfa –  $\alpha$  [W/(m<sup>2</sup>·K)], can vary, however for general evaluation  $\alpha = 10$  W/(m<sup>2</sup>·K) can be used.

Consequently to heat 1 m<sup>2</sup> of floor up to 9 °C in relation to air temperature, approximately an installation of  $9 \text{ °C} \cdot 10 \text{ W}/(\text{m}^2 \cdot \text{K}) = 90 \text{ W}/\text{m}^2$  is required.

As a “rule of thumb” a safety value of 30% should also be added offering a minimum output for electrical heating element used in comfort floor heating system as calculated in the following example:  
 $90 \text{ W}/\text{m}^2 \cdot 1,3 \approx 120 \text{ W}/\text{m}^2$ .

**Recommendation:** output for comfort floor heating systems should be no less than 120 W/m<sup>2</sup>, unless any special restrictions are specified.

The following power outputs for comfort floor heating systems are recommended based on floor constructions, insulation levels, surface types, room air temperature and individual user preferences:

- Wooden floor constructions – no more than 100 W/m<sup>2</sup>;
- Dry rooms, thermal insulated floors – 100 W/m<sup>2</sup> or more;
- Floors without thermal insulation – 130-160 W/m<sup>2</sup>;
- Wet rooms – 150-180 W/m<sup>2</sup>;
- Low voltage, insufficient insulation, covered balcony slabs – 160-200 W/m<sup>2</sup>;
- maximum output in floor construction – should not exceed 200 W/m<sup>2</sup>.

Find more details and restrictions for special floor constructions such as wood, later in this document.

Comfort floor heating systems do not require heat loss calculation. It is advised to install power at least  $100 \text{ W/m}^2$  in all dry premises, and at least  $150 \text{ W/m}^2$  in wet premises, however note that norms for wooden floors specify no more than  $100 \text{ W/m}^2$ , and require a thermostat with a floor sensor to limit maximum floor temperature. Heating system must be controlled by thermostat and it is worth mentioning that installation of increased power, e.g.  $150 \text{ W/m}^2$  instead of  $100 \text{ W/m}^2$  does not affect energy consumption of the system, but can influence user comfort feeling.

### C-C distance

Heating cables are installed inside floor construction with some distance between them (or so called installation step, centre-centre or cable-to-cable distance: C-C distance). To achieve a warm floor with even distribution of heat and to provide comfortable temperature on the floor surface, the floor surface temperature variation should not exceed  $1,5 \text{ }^\circ\text{C}$  (e.g. DIN 44576). There will always be a difference in temperature on the floor surface, in areas between heating cables and directly above them. The bigger C-C distance – thicker layer of concrete above cable is necessary to ensure a uniform/comfort temperature distribution along the floor surface. This difference is always more pronounced during periods, when electrical heating cables are turned on (providing heat to the floor heating). The instant thermostat disconnects the heating cables, because desired floor temperature is reached, the temperature on the top of the floor surface is equalized greatly, giving an increasingly comfortable floor surface.

A rule of thumb indicates:

- The thickness of concrete & floor structure above the heating cables need to be  $\sim 1/2$  the C-C distance.

Here is the additional explanation:

For Warm Floor system installed into a thick concrete slab the C-C distance of 5-10 cm is recommended. The thickness of the concrete slab top layer is usually not less than 3-5 cm, regardless whether heating cables are to be installed there or not. For

thin floor constructions, such as tile glue, laminate etc., the C-C distance should not exceed 10 cm and is recommended to be even less: 7,5 cm. To install heating cables under the tile glue the best solution is Danfoss thin heating mats with C-C = 7,5 cm that guarantees floor surface without cold zones.

**Recommendation:** it is always advised to insulate the floor structure below the heating cables.

More details about cable installation step (C-C distance) and appropriate outputs are described below in this document.

### Thermostat with floor sensor:

The thermostat uses a wire sensor to measure the temperature inside the floor construction. The sensor needs to be placed directly between, and if possible, slightly above the lines of a heating cable or a mat. Temperature measured by the floor sensor is not the real surface temperature and depends on placement of the floor sensor. It is difficult to give any recommendations about the thermostat settings for a specific floor construction.

The thermostat with a floor sensor has a scale without degree marking.

### 4.1.2. System Design

Following stages will help you to find a right solution for your comfort floor heating system (more about Danfoss products find in the Danfoss Product Catalogue and data sheets):

#### Choice of a heating element type (mat or cable).

Define the thickness of floor construction over the cable, and a type of the installation. For example for renovation, where small floor structure needs to be enlarged, a heating mat is a preferable solution due to the element's height.

If you plan to increase the floor construction by less than 30 mm, it's preferred to use a heating mat, suitable for floor increase of 3-5 mm.

If you plan to increase the floor construction by more than 30 mm, a heating cable is usually applied. It

should be noted that there are no restrictions for use of heating mats in concrete or thick floor constructions. The question of thermal insulation, installation thickness in floor construction should also be addressed, as it's important to minimize heat losses downwards.

#### Choice of specific output.

Specific output ( $p$  in  $[\text{W/m}^2]$ ), for Comfort Floor Heating usually does not require calculation and is selected from recommendations for specific floor construction and environment. For standard floors without insulation the output of no less than  $100 \text{ W/m}^2$  is usually chosen and for wet rooms – no less than  $150 \text{ W/m}^2$ . In the lack of reliable information about the floor construction, flooring type, supply voltage, etc., it is better to choose an output as close as possible to the maximum recommended (see page above).

To fix heating cables ECFast fitting bands are usually applied, it offers a cable attachments with a step distance (C-C) of 2,5 cm.

This leads to the situation that the value of the specific output for a heating cable cannot be chosen arbitrarily, and it should be taken into consideration that the cable can be installed at 2,5 cm intervals only, and respectively output will match attachment distance.

For example if:

- cable is ECflex 18T,
- supply voltage is 230 V,
- the C-C distance of 12,5 cm gives output of  $145 \text{ W/m}^2$ .

And for installation step with the C-C of 10 cm –  $180 \text{ W/m}^2$  (see the Danfoss Product Catalogue for product selection). Thereby, for heated area the value of the specific output –  $p_{INST} [\text{W/m}^2]$ , which is actually installed, should be chosen for fixed C-C, following the table or calculated value.

It should be noted that in some countries the supply voltage is lower than 230 V that leads to decrease of the cable specific output and respectively, different  $[\text{W/m}^2]$  with the same step (C-C). For example, if the given output is 230 V the coefficient of 0,915 should be applied with 220 V supply.

### Estimation of heated floor area.

Installation area of heating cable/mat has to be calculated  $A_{INST}$  [m<sup>2</sup>]. To do this, from the total area of the room (in [m<sup>2</sup>]), the area under stationary objects (bath, toilet, shower, cabinet, cupboards, etc.) and a strip of free floor along walls (usually 10-15 cm wide) is deducted, as well as special customer's preferences should be taken into account.

The heating cable or mat is set into the floor for many years, so it's advised to exclude from heated area items/furniture that can be moved over the operation life of the premises: cupboards, cabinets, bed etc.

Along the interior walls, where any furniture most probably will be located up to 30-40 cm can be allowed. For heating systems installed in the floor construction, furniture on legs, that provide air circulation underneath is recommended.

### Choice of a specific heating element (length of heating cable or area of heating mat).

Heating cable is normally chosen based on required heating output for room (the calculated total output  $P_{CALC}$  [W]). This output is calculated as the chosen specific output  $P_{INST}$  [W/m<sup>2</sup>] multiplied by the installation area  $A_{INST}$  [m<sup>2</sup>]:  $P_{CALC}$  [W] =  $P_{INST}$  [W/m<sup>2</sup>] ·  $A_{INST}$  [m<sup>2</sup>]. The heating element is selected from the product list of factory-produced elements, with specific output  $P_{INST}$  [W]. Always the product nearest to, but larger than, calculated total output  $P_{CALC}$  [W], is to be chosen. For indoor heating Danfoss recommends to use screened twin conductor ECflex 18T, ECflex 10T, heating cables or if nothing else is suitable, a screened single conductor ECbasic 20S heating cable.

**Note.** The number at the end of the cable's name refers to: its specific output for 1 m in [W/m] at 230 V, and letter "T" means a twin conductor cable (Twin), letter "S" - single conductor cable (Single).

The most frequently used cable type is ECflex 18T – twin conductor, 18 W/m at 230 V (16,5 W/m at 220 V). A linear output of ECbasic of 20 W/m, is not the best choice for even temperature distribution along the floor construction, if installed in the same floor, compared to 10 or 18 W/m.

The heating mat is selected from a range of factory-produced elements (covering area from 0,5 to 12 m<sup>2</sup>), with an area covering usually the nearest less value to available installation space  $A_{INST}$  [m<sup>2</sup>]. If the installation area ( $A_{INST}$  [m<sup>2</sup>]) exceeds 12 m<sup>2</sup>, a multiplication of chosen heating mats needs to be applied.

For example, Danfoss screened heating mats designed for floor installation have the cable/mat thickness for:

- twin conductor of ~3,5 mm: ECmat 100T, ECmat 150T;
- twin conductor of ~4,0 mm: ECcomfort 100T;
- single conductor of ~3,0 mm: EHeat 150S.

**Note.** The number at the end of a mat's name refers to its specific output for 1 m<sup>2</sup> in [W/m<sup>2</sup>] at 230 V, and letter "T" means twin conductor mat (Twin), letter "S" a single conductor mat (Single).

A single conductor heating mat requires more planning before installation, to ensure that the power supply cord attached to both ends of the heating mat starts and ends at the same place.

For Comfort Floor Heating ECmat 150T and EHeat 150S heating mats are used most often – 150 W/m<sup>2</sup> at 230 V (135 W/m<sup>2</sup> for 220 V).

### Calculation of the fitting band length (ECfast).

If heating cable is applied, it is recommended to use fitting band to fix it to the floor base. For example, metal galvanized ECfast fitting band. It is attached to the floor (nailed or fixed with screws or glued) in parallel lines, usually every 50 cm.

This equals 2 meters of band for each square meter [m<sup>2</sup>] of cable installation.

Simple calculation of the fitting band length  $L_{FIX}$  (m): cable installation space is multiplied by two, e.g.

$$L_{FIX} = S_{INST} \cdot 2 \text{ (m)}.$$

### Thermostat selection.

Thermostat for Comfort Floor Heating system should be fitted with a floor temperature sensor.

### Choice recommendations:

heating area is larger than 5 m<sup>2</sup> – programmable thermostat with timer, for example, ECtemp Smart; smaller than 5 m<sup>2</sup> – simple one without a timer, for example, EFET 530 or EFET 130, can be chosen. Simple thermostats are only recommended due to their lower cost, and as there are no restrictions for use of thermostat with timer for small areas.

The maximum output, that thermostat is able to switch on usually varies between 3450-3600 W (15-16 A). This needs to be taken into consideration for larger rooms. If more than maximum is needed the following two solutions are possible:

1. Heating area is divided into independent zones with separate cables and individual thermostats. Each zone not exceeding the connected output indicated above, and with the same output (in [W/m<sup>2</sup>]) installed;
2. Contactor (additional relay) with increased maximum current is used (e.g. 20 A or more), usually mounted on a DIN rail in the electrical switchboard.

**Recommendation:** it is advised to choose thermostat load of 70-80% of maximum.

### Choice of additional equipment.

Mounting box for thermostat, conduit pipe for floor temperature sensor, screws, nails or anchors for attaching fitting band to the floor, etc.

It is assumed that the voltage supply is stable and properly connected, according to electrical laws of the

country of installation e.g. fuse and RCD (Residual Current Device) are installed in switchboard, section and length and cross section area

of power supply cable are properly chosen. Otherwise these elements have to be selected too.

#### Floor construction.

Follow installation instructions provided by manufacturers of floor elements, and local building regulations.

### 4.1.3 Design Example. Calculation and selection of equipment

#### Comfort floor heating for bathroom.

Input data: bathroom, 2nd floor (over heated room), no floor insulation, size 3 x 4 m, total area of 12 m<sup>2</sup>, with installed 0,9 x 1,7 m bathtub, stable power supply voltage of 230 V, floor surface made of tiles.

Restrictions for the floor height: can be increased maximum by 2 cm.

#### Heating mat or cable?

Since the floor height is an issue the concrete thickness is less than 3 cm. Choose a mat, ECmat or ECcomfort twin conductor screened mat (find a detailed description of products in the Danfoss Product Catalogue).

#### Installed output.

Wet room, stable voltage, 2-nd floor, tiles, heated room below: an output of 150-180 W/m<sup>2</sup> (chapter 4.1.1) is recommended.

#### Calculation of heated floor space (area of cable installation).

Out of the total space *A* (in [m<sup>2</sup>]) bathtub area (0,9 x 1,7 m) and strips of floor of 10 cm along the walls are subtracted:

$$A_{INST} = 12 \text{ m}^2 - (0,9 \text{ m} \cdot 1,7 \text{ m}) - ((3 \text{ m} + 4 \text{ m}) + (3 \text{ m} - 0,9 \text{ m}) + (4 \text{ m} - 1,7 \text{ m})) \cdot 0,1 \text{ m} = 12 \text{ m}^2 - 1,53 \text{ m}^2 - 1,14 \text{ m}^2 \approx 9,33 \text{ m}^2.$$

#### Select the desired mat size.

Available floor area is 9,33 m<sup>2</sup>.

ECmat 150T covering 9 m<sup>2</sup> of floor, and with total output of 1235 W at 230 V, is chosen.

If the mat covering 10 m<sup>2</sup> of floor is chosen, there will be a surplus of 0,67 m<sup>2</sup> of mat, and since it's not allowed to cut or shorten a heating cables and mats, the mat covering 9 m<sup>2</sup> of floor is a preferred choice.

#### Fitting band.

It is not needed, since ECmat has a self-adhesive glue on the underside. We advise to clean the floor and remove all debris and dust.

#### Thermostat selection.

ECmat 150T with 1235 W output, less than 3450- 3680 W maximum allowed, can be connected to a Danfoss thermostat. For the heating area exceeding 5 m<sup>2</sup> – thermostat with a timer is recommended. For example, choose the most modern programmable WiFi thermostat with intelligent timer – ECtemp Smart.

Type	System	Temperature sensor	Range	IP class	Load, max.
ECtemp Smart	Programmable: Comfort Floor Heating or Direct Heating with floor temperature limiting	Air: embedded, Floor: included wire sensor	Floor 5...45 °C. Air 5...35 °C	IP21	3680 W

As an option, simple thermostat with floor sensor can be chosen: e.g. EFET 530. When thermostat is installed in a wet room, the requirements of electrical safety norms and corresponding IP class should be strictly followed! It is recommended to install the thermostat outside the bathroom.

#### Additional equipment.

Electrical materials necessary for installation will typically include the following: wall mounting box for thermostat, 4-5 m conduit pipe for a floor temperature sensor and additional power supply if necessary. It is assumed that there is a proper power supply, according to the rules

and regulations for safety elements of electrical installation, e.g. fuse and RCD are installed.

#### Summary:

For comfortably warm floor in 12 m<sup>2</sup> bathroom (with free area of 9,33 m<sup>2</sup>), the following Danfoss floor system elements are recommended:

Equipment	Characteristics	Quantity
Twin conductor screened ECmat 150T heating mat	9 m <sup>2</sup> , 1235 W at 230 V, 150 W/m <sup>2</sup>	1 pc.
ECtemp Smart thermostat	Programmable, WiFi, APP enabled, intelligent timer, air and floor sensors, IP21	1 pc.
Conduit pipe	Ø 16	4 m
Mounting box		1 pc.



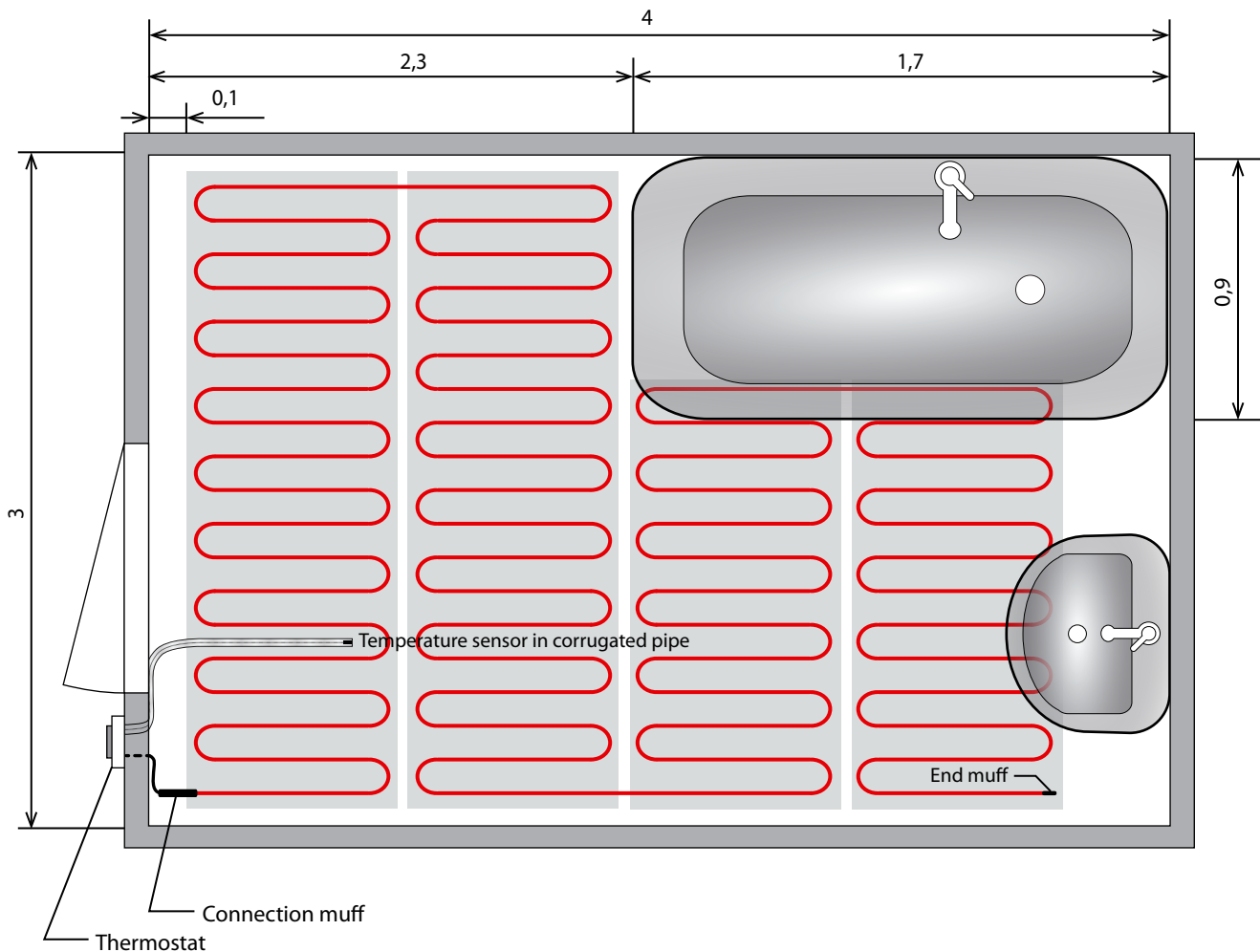

Fig. 1 – Example of heating mat installation in bathroom. All distances are in [m].

## 4.2. Total (Direct) floor heating

### 4.2.1. About the system

Total or Direct electrical floor heating is the only heating system installed in a room (or area) for maintaining a user specified room temperature. It is ensured by adjusting floor surface temperature, due to the changeable heat transfer from the surface of the floor. Such a system is regulated by a thermostat with air & floor or only room temperature sensor. Air room sensor is an integrated part of EFET or ECtemp room thermostats. A floor heating system has a large heated surface of the floor, and it is a convection and radiation heating system. Advantage of a floor heating system is to provide heat in the lower part of a room near legs and relatively less heat around room ceiling, where it's not so highly needed. It is proven by many studies, that such temperature

division is the most comfortable for any person, independent of gender, age and activity level. Floor heating system provides a feeling of the same or improved thermal comfort at lower overall room temperature setting.

As a result, it can be lowered by app. 1...2 °C, compared with an earlier used radiator heating system, with heating element installed visibly under the window. This provides a user with improved thermal comfort and energy savings of approximately 10-20%.

Output of a heating system is chosen based on the level of calculated heat loss (in Watts). Energy, which is provided via a floor heating system, must cover heat loss and support a specified air (room) temperature. Usually a safety factor of 20-30% is added to the heat loss calculated

output value, depending on room's specific thermal condition. As the heating system is controlled by a thermostat, installing larger power output does not affect the overall consumption of electrical energy for heating.

Total electrical floor heating, (Heating via floor) should not be confused with "Comfort Floor Heating/Warm Floor". The need for warmth is variable, because of the changing outside temperatures during the heating period, and accordingly floor temperatures varies too. As an example, in October, when the outside temperature is +5 °C, it would be enough to heat the floor up to 21...22 °C to maintain indoor temperature of 20 °C. But in February, when the outside temperature is lower e.g. -15 °C, floor will be heated more

e.g. 25...26 °C, to maintain the same room temperature.

When utilizing floor heating system for total heating you should always choose as technically correct solution, but observe the limitation of the maximum floor temperature. For regulation of a total heating system a thermostat measuring air (room) temperature and fitted with floor temperature sensor is the preferred choice. Allowing setting maximum floor temperature level and constantly monitoring prevents overheating of floor. Such limitations are strictly necessary for floors with wooden surface.

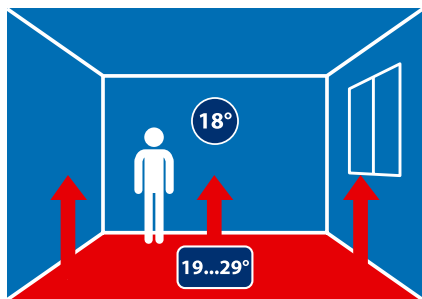

Special Danfoss thermostats are used where setting of the maximum floor temperature is necessary or advisable:

- in programmable models: by setting of special option.
- in simple models: by manual potentiometer under the thermostats cover.

Factory default setting for maximum floor temperature limit is 35 °C.

Even if a specific floor installation doesn't particularly require a floor sensor to be installed, it's strongly advised to do so. Install a plastic pipe conduit where, at later date, floor sensor could be fitted. The heating element (cable or mat), is installed in the floor construction where it forms parallel lines. When using a heating cable: output density of heating system (in  $[W/m^2]$ ) is determined by C-C distance (cable-to-cable or center-to-center distance) of heating cable. Increasing the distance between cables leads to decreasing of output and vice versa. When a desired output density is calculated and chosen, than C-C distance, that will determine the number of cable lines per  $1 m^2$  of

floor or the cable length per  $1 m^2$  is calculated. Multiplying the chosen cable length on a total area of heating cable installation will give the calculated length of heating cable.

$$\begin{aligned} \text{C-C distance (cm)} &= \\ &= \frac{\text{Available floor area (m}^2) \cdot 100 \text{ (cm/m)}}{\text{Length of chosen cable (m)}} \end{aligned}$$

Detailed information about cable installation procedure is found later in this document.

For modern houses or dwellings calculated heat loss is small and, consequently, the output of floor heating system is also limited. As a result, to prevent a heating cable from being installed with a large C-C distance, it's advisable to use one with less linear output. For example, for calculated heat loss of  $50 W/m^2$ , when using the most common Danfoss cable: ECflex 18T, the C-C distance will be as big as 36 cm. That will inevitably lead to a floor surface pitted with cold zones situated between lines of the installed heating cable. As aim for a floor heating system is to achieve and maintain a constant and comfortable floor temperature, for heating systems with required low specific output, we recommend heating cables with lower linear output (in  $[W/m^2]$ ): for example ECflex 10T.

This allows reduction of C-C distance and leads to a more even temperature division on the floor.

#### **Safety coefficient.**

For heating systems installed in floor structure, it's necessary to add a safety coefficient of 1,2-1,3, when designing a power output that needs to be installed in the floor. This factor is an experience value used by the industry, and is based on following facts:

- heating cables length, resistance and wattage tolerance,
- power supply voltage has some accuracy,
- heat loss downwards, floor buildup, and surface material type.

#### **Floor surface temperature.**

It should be taken into account that the big heat loss leads to necessity of big output from a heating system and, accordingly, to high and perhaps not a comfortable temperature on the

surface of the floor. The maximum temperatures of the floor surface for different types of applications are specified in the relevant standards. For a rough estimation of the possible floor temperature for a given output the value of heat exchange coefficient of  $\alpha = 10 W/(m^2 \cdot K)$  (more description is found in paragraph about Comfort floor heating) should be used. For example, if the output of the heating system is  $150 W/m^2$  and heat loss down is  $\sim 20\%$ , than the heat flow up is  $150 - (150 \cdot 20\%) = 120 W/m^2$ . If actual heat loss is close to that value, it will imply a requirement of an increase of a floor surface temperature with as much as  $12^\circ C$  ( $120 W/m^2 / 10 W/(m^2 \cdot K)$ ) in relation to air temperature. E.g. if the air/room temperature is  $18^\circ C$ , the floor temperature can reach  $18 + 12 = 30^\circ C$  in the coldest time of the year to satisfy the rooms actual heat loss.

#### **4.2.2. Calculation and selection of elements/products**

For more detailed information refer to the Danfoss Product Catalogue and previous chapters of this document.

#### **Estimation of a heating system's calculated output.**

Define heat loss of the premises  $Q$  [W]: from documentation or by calculation (e.g. EN 12831).

Floor heating system calculated output is determined with taking into account a safety factor of 1,3:

$$P = Q \cdot 1,3 \text{ [W].}$$

#### **Choice of a specific heating element (mat or cable).**

Define the thickness of floor construction over the cable. If planned concrete height is 3 cm or more, heating cable is usually installed, if floor construction is thin (tile adhesive, etc.), heating mat (with thickness of  $\sim 3-4,5$  mm) is a preferred choice. It should be noted that there are no restrictions for use of heating mat in concrete or thick floor construction.

It's strongly advised to install insulation in the floor construction if possible. Its thickness should be selected according to local norms. When heating system works for a fairly long period during the year (e.g. in the Nordic countries for 6-8 months per year), thickness of thermal insulation in the floor has a direct influence on level of heat loss and therefore additional electricity costs. For the durability of the floor construction concrete installed over/ onto insulation, has to have a thickness of at least 3 cm and be in accordance with local building norms.

### Estimation of heated floor area.

To estimate installation area of heating cable or mat  $A_{INST}$  (in  $[m^2]$ ): deduct the area, where cable is not installed, from the total area of the installation (room). It's recommended that strip along the walls without cable/mat has width of ~ 10-15 cm and along the interior walls, where furniture will be most probably installed, is within 30-40 cm. For heating systems in the floor construction, furniture on legs (min. 5 cm of air gap to the floor) is advised, allowing airflow underneath, so the cable/mat under the furniture will not overheat.

### Estimation of the calculated output per $[m^2]$ .

Specific calculated area output,  $p_{CALC}$   $[W/m^2]$  is calculated by dividing the calculated heat loss  $Q$   $[W]$  by the installation area  $A_{INST}$   $[m^2]$ :

$$p_{CALC} = Q / A_{INST} \text{ [W/m}^2\text{]}.$$

It should be noted that the calculated output is typically slightly less than real chosen output of heating cable, which is installed in the floor. This is due to the fact that cable can be attached on ECfast fitting band with a fixed distance of 2,5 cm (or multiplication thereof) only.

### Choice of length of heating cable or area of heating mat.

Total cable/mat output should not be less than the calculated heat loss, including the safety factor of 1,3.

### Heating cable.

Cable is usually fixed with help of ECfast metal fitting band, with cable attachment points every 2,5 cm and allows to implement different fixed output on 1  $[m^2]$ . This fact should be taken into consideration during calculation of a specific solution. For example, if the cable is ECflex 18T and supply voltage is 230 V for C-C distance of 12,5 cm, output is 145  $[W/m^2]$ , and for C-C = 10 cm – 180  $[W/m^2]$  (See also Appendix A.1).

It should be noted that in some countries supply voltage is lower than 230 V, which leads to a decrease in cable output and, respectively, different  $[W/m^2]$  with the same installation distance. For example at 220 V electrical supply, the output from a heating element, rated at 230 V is only 91,5% (coefficient 0,915 should be applied to heating element output from Danfoss Product Catalogue).

For heating cable with defined installation C-C distance, a specific output  $p_{INST}$   $[W/m^2]$  is selected, with help of a product table or calculated using the formula. Usually a product with nearest larger value to calculated output  $p_{CALC}$  is chosen. This chosen/ calculated output will be the actual output for 1  $m^2$  of the heating system. In other words, it is area specific output  $p_{INST}$   $[W/m^2]$  of selected heating cable installation C-C distance.

Heating cable total output  $p_{CALC}$   $[W]$  is calculated as the specific output  $p_{INST}$   $[W/m^2]$  multiplied by the installation area  $A_{INST}$   $[m^2]$ :

$$p_{CALC} \text{ [W]} = p_{INST} \text{ [W/m}^2\text{]} \cdot A_{INST} \text{ [m}^2\text{]}.$$

Cable is selected from a list of factory produced products, with output  $p_{INST}$   $[W]$ , usually the nearest larger to calculated output  $p_{CALC}$   $[W]$ . The nearest lower output can only be recommended, if it differs from the estimated no more than ~5%.

Output of the selected cable is the actual output of the heating system.

For total room heating Danfoss recommends to choose screened twin conductor ECflex 18T, ECflex 10T, heating cables or, only if necessary, a single conductor ECbasic 20S heating cable.

**Note.** The number at the end of the cable's name refers to its specific output for 1 m – W/m at 230 V, letter T – twin conductor cable (Twin), letter S – single conductor cable (Single).

In floor construction the most frequently used cable is ECflex 18T – twin conductor, 18 W/m at 230 V.

### Heating mat.

When installing thin heating mat, it is chosen with a specific output  $p_{INST}$   $[W/m^2]$  the nearest larger to calculated output  $p_{CALC}$ . However installation also needs to look at the available floor area  $A_{INST}$   $[m^2]$ , and choose a mat, that covers an area close to available. Otherwise installation will leave unheated and cold floor areas, resulting in users dissatisfaction with the total heating system.

For example, Danfoss screened heating mats designed for installation in floor construction:

- twin conductor of ~3,0 mm: ECmat 100T, ECmat 150T;
- twin conductor of ~4,0 mm: ECcomfort 100T;
- single conductor of ~3,0 mm: ECheat 150S.

**Note.** The number at the end of the mat's name refers to its specific output for 1  $m^2$  in  $[W/m^2]$  at 230 V, letter T – twin conductor mat (Twin), letter S – single conductor mat (Single).

For example, ECcomfort 100T heating mat is a twin conductor, 100 W/m<sup>2</sup> at 230 V (91 W/m<sup>2</sup> at 220 V).

Output of the selected heating mat will be the actual output of the heating system.

### Calculation of the length of the fitting band.

If heating cable is chosen, it is recommended to use fitting band to fasten it to the floor base, for example, galvanized ECFast fitting band. ECFast is usually attached to the floor (screwed, nailed or glued) in parallel lines spaced every 50 cm, but not more than 1 m. As a result, approximately two meters of band for each square meter of installation area are used.

Calculation of fitting band length  $L_{FIX}$  (m) - cable installation area is multiplied by two:

$$L_{FIX} = A_{INST} \cdot 2 \text{ [m]}.$$

Alternatively, if installation allows, heating cable can be fixed to metal reinforcement mesh placed in the floor construction.

### Choose a thermostat.

Thermostat designed for electrical floor heating system for total heating is fitted with an internal air temperature sensor and usually with an additional floor temperature sensor (included with thermostat).

The floor sensor allows controlling and limiting the maximum temperature of the floor surface. This restriction is often mandatory and standardized for some producers of floor coverings, e.g. for laminate or parquet boards.

Following is recommended, if:

- heating area is larger than 5 m<sup>2</sup>: programmable thermostat with timer, for example, ECtemp Smart or ECtemp Touch
- heating areas is smaller than 5 m<sup>2</sup>: simple thermostat without timer, for example, EFET 532 or EFET 132, can be chosen.

Simpler thermostats are only recommended in terms of their lower cost. But for heating system thermostats with timer are the most energy-efficient choice, since there is a possibility to save energy during the absence of people in the room, e.g. reduce temperature in the room at night.

Thermostats have an internal relay that has a limitation of the maximum output, that thermostat can switch on: typically 3450-3680 W (15-16 A).

In case of need to install more than maximum, following two solutions are possible:

1. Heating area is divided into independent zones with separate cables and individual thermostats,

each zone not exceeding the connected output indicated above, and with the same output (in [W/m<sup>2</sup>]) installed;

2. Contactor for proper current issued (additional larger relay), usually mounted on a DIN rail in the switch panel.

**Recommendation:** it is better to choose thermostat load at 70-80% of maximum.

### Choice of additional equipment.

Mounting box for thermostat, conduit pipe for floor temperature sensor, nails or anchors for attaching fitting band to the floor, etc.

It is assumed that the voltage properly supplies the place of the thermostat installation, e.g. fuse and RCD are installed in switchboard, section and length of power cable are properly chosen, etc. Otherwise these elements have to be selected too.

### Floor construction.

In multi-layer floor construction, consisting of many elements, a wide range of considerations need to be made. Always follow the national rules for construction and in case of uncertainty get in contact with your local Danfoss product supplier.

## Example. Direct Floor Heating – calculation and selection of equipment

### Total heating system for new build living room.

Total heating via electrical floor, using the heating cable including limiting of maximum floor temperature.

Data:

Room size 3 x 5 m, total area of 15 m<sup>2</sup>, concrete floor, stable supply voltage 230 V, ground floor, concrete is assumed more than 3 cm thick, calculated heat loss is 1100 W.

### Definition of cable system's calculated output.

The calculated heat loss  $Q$  is 1100 W. To select heating cable(s) take into account the safety factor of 1,3, the calculated output is:  $P = 1100 \text{ W} \cdot 1,3 = 1430 \text{ W}$  or per [m<sup>2</sup>]: 95,3 W/m<sup>2</sup>.

### Choice: heating mat or cable.

Concrete is assumed not less than 3 cm thick, floor construction is "thick". Twin conductor screened ECFlex 18T heating cable is chosen for installation.

It is assumed that insulation of necessary thickness will be laid under the cable, so downward heat loss is minimal and does not require taking into account.

### Estimation of heating cable installation area.

It is proposed that the cable is placed at a distance of 10 cm (0,1 m) from the 3 m length outer wall and the same from opposite wall with the door. Permanent (fixed) installations are supposed along the 5 m length inner

walls. It is proposed that the cable is placed at a distance of 35 cm (0,35 m) from 5 m length inner walls. Under these assumptions for 3 x 5 m room the area for cable installation is:

$$\begin{aligned} A_{INST} &= 15 \text{ m}^2 - (3 + 3) \text{ m} \cdot 0,1 \text{ m} - \\ &\quad - (5 + 5) \text{ m} \cdot 0,8 \text{ m} = \\ &= 15 \text{ m}^2 - 0,6 \text{ m}^2 - 3,5 \text{ m}^2 = \\ &= 10,9 \text{ m}^2 \approx 11 \text{ m}^2. \end{aligned}$$

### 4. Estimation of the calculated output per 1 m<sup>2</sup>.

The calculated heat loss  $Q$  [W] should be divided into cable installation area  $A_{INST}$  [m<sup>2</sup>]:

$$\begin{aligned} p_{CALC} &= Q / A_{INST} = 1430 \text{ W} / 11 \text{ m}^2 = \\ &= 130,3 \approx 131 \text{ W/m}^2. \end{aligned}$$



## Calculation of the length of the heating cable

Choose twin conductor screened ECflex 18T heating cable. Cable installation on ECfast fitting band requires the choice of C-C distance with step of 2,5 cm (see Appendix A.1.). Specific output  $p_{INST}$  [W/m<sup>2</sup>] is selected by the table or calculated using the formula as the nearest larger settlement to calculated output  $p_{CALC}$ .

For calculated above  $p_{CALC} = 131$  [W/m<sup>2</sup>] for cable 18 [W/m] – ECflex18T, choose from the table the nearest larger specific output (at 230 V) and appropriate C-C distance (see Appendix A.1):

C-C distance, cm	18 W/m ECflex18T
...	...
12,5	144 W/m <sup>2</sup>
15	120 W/m <sup>2</sup>
17,5	103 W/m <sup>2</sup>
...	...

Choose specific installation output  $p_{INST} = 144$  W/m<sup>2</sup> and respectively C-C = 12,5 cm.

**Note.** For the heating system, mat heating element can be installed in concrete too. The nearest larger to  $p_{CALC} = 131$  W/m<sup>2</sup> is mat output 150 W/m<sup>2</sup>, so mats which names end with 150T are suitable (ECmat 150T, etc.).

Heating cable calculated specific output:

$$P_{CALC} = p_{INST} \cdot A_{INST} = 144 \text{ W/m}^2 \cdot 11 \text{ m}^2 = 1584 \text{ W}$$

Factory-produced cable ECflex 18T with the nearest larger to 1584 W output is 1625 W cable 90 m (see Danfoss Product Catalogue) .

It should be noted that cable with less power – 1485 W (82 m) could not be selected as a variant, because its power varies more than 5% from the calculated of 1584 W.

## Calculation of the length of the fitting band.

Using of metal fitting band ECfast for cable fixing is supposed. Band is attached to the floor in parallel lines spaced every 50 cm. So band length can be defined as the area of cable installation multiplied by two:

$$L_{FIX} = A_{INST} \cdot 2 = 11 \text{ m}^2 \cdot 2 = 22 \text{ m} \approx 23 \text{ m}$$

You can choose, for example, 1 packaging of 25 m of ECfast.

## Thermostat selection.

Thermostat designed for heating system has to be selected. e.g. thermostat with air temperature sensor and an additional floor temperature sensor. The heating system will operate during the whole heating period: therefore, it is important to save electricity. To do this, choose thermostat with timer, with possibility to set low temperature at night and during periods of absence of people in the room.

For rooms with area smaller than 5 m<sup>2</sup>, consider also the economic implication of choosing a thermostat without timer.

For this example the selected heating cable's output is 1625 W. It is less than the maximum allowable 3500 W (15-16 A) for most Danfoss thermostats. For example, ECtemp Smart thermostat: it can be used for comfort or total room heating, with the ability to limit the maximum floor temperature. With Danfoss Smart APP, an intelligent timer and stylish design, it should be installed in the wall mounting box, maximum load is 3,7 kW (16 A), 230 V, IP21.

## Choice of additional equipment.

Mounting box for thermostat, conduit pipe for floor temperature sensor, nails or anchors for attaching fitting band to the floor, etc.

It is assumed that there is a stable voltage supply to the place of the thermostat installation, and safety fuse and RCD are installed in switchboard, section and length of power cable are properly chosen, etc. Otherwise these elements have to be selected too.

Summarizing the above:

Danfoss electrical floor heating system for total heating (Direct Heating via Floor) with limitation of maximum floor temperature is implemented for a floor area of 15 m<sup>2</sup> with calculated heat loss of 1100 W, following equipment is needed:

Equipment	Characteristics	Quantity
Twin conductor screened heating cable ECflex 18T	90 m, 1625 W (at 230 V), C-C distance of 12,5 cm, ~144 [W/m <sup>2</sup> ], available floor area of 11 m <sup>2</sup>	1 pc.
ECfast Metal fitting band	Galvanized metal, distance of 2,5 cm	1 pc. of 25 m pack
ECtemp Smart thermostat, white	Programmable, Wi-Fi, accessible with APP, intelligent timer, air and floor sensors, IP21	1 pc.
Conduit pipe	Ø 16	4 m
Mounting box		1 pc.

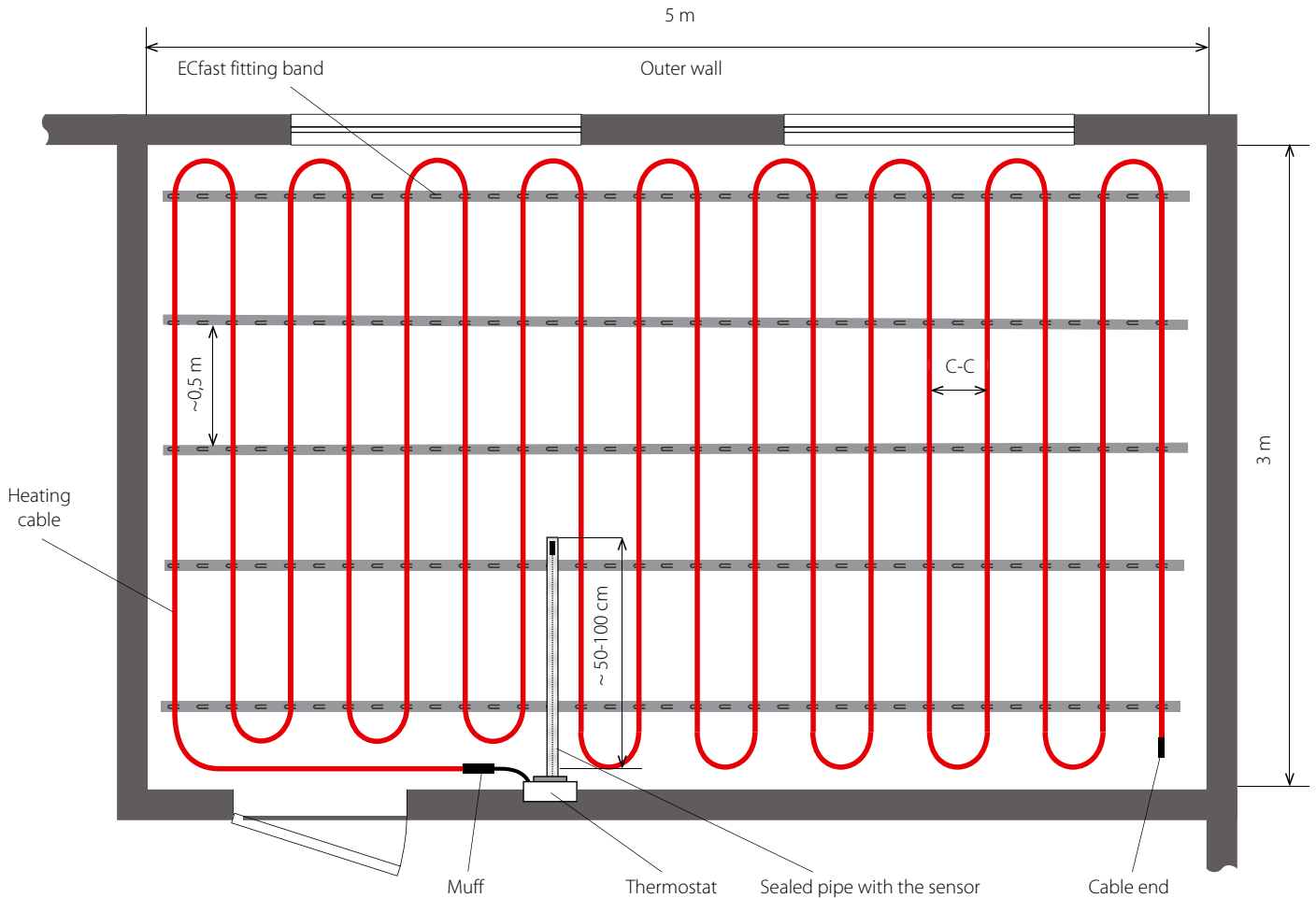

Fig. 2 - Example of heating cable installed in a room. Direct Floor Heating

## 4.3. Accumulating heating via electrical floor heating system

### 4.3.1. About the system

Danfoss's accumulating heating system is designed to be used in houses, offices, and factories where there is an opportunity to use electricity during low tariff periods.

The heating cables are embedded in a thick layer of concrete (7-15 cm) typically >10 cm, that accumulates the heat produced during the low tariff period. The bigger amount of concrete is installed, enveloping the heating cables, the bigger is the thermal capacity of the floor (more energy can be stored).

#### Installed output.

As already described in the previous chapter, the heat loss in a room needs to be known in order to calculate the installed output for accumulating heating.

A low tariff period of e.g. eight hours during night means that the cables/mats have eight hours to generate the

required amount of heat to be released over approximately the next 16 hours before the next low tariff period sets in. So output for this accumulating system has to be 3 times higher than output of direct heating system. To ensure that the system responds quickly, a safety factor of approx. 1,3 has to be included in the output calculation.

It should be noted that air (room) temperature regulation is different, with almost no possibility of adjustment during day. That's because floor is overheated in the morning, due to heat accumulation in the night, and under-heated at the end of a day. Difference of the air (room) temperature, according to standards, usually should not be more than 4 °C. To avoid uncomfortable room temperatures at winter time, it is advised to install an additional direct heating system. It has to be designed in such way, that the accumulating heating system should be supplemented by direct cable rim zone heating, or other heating source.

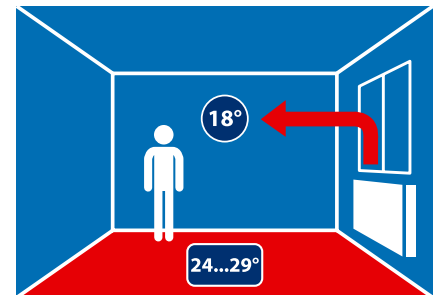

Accumulating heating system has to be controlled by special timer thermostat, to regulate the floor storage heating during low tariff periods and save energy. Thermostat is usually connected to an outdoor sensor, in order to constantly measure an outdoor temperature or weather conditions, and calculate amount of energy which has to be stored in floor. Alternatively a thermostat with a timer can also be used as a regulation unit.

More information about accumulating heating can be found in specialized standards, e.g. DIN 44576.

## 4.3.2. Calculation and selection of equipment for Accumulating heating system

### Installed output

As already described in the previous paragraph, the heat loss in a room needs to be known in order to calculate the installed output for accumulating heating.

To ensure that the system responds quickly a safety factor of approx. 1,3 has to be included in the calculation.

A low tariff period of e.g. eight hours means that the cables/mats have eight hours to generate the required amount of heat to be released over approximately the next 16 hours before the next low tariff period sets in.

The following equation is used to calculate the total required output [W] for accumulating heating systems:

$$P = \frac{\text{Calculated heat loss} \cdot T \cdot C}{t}$$

Where:

- T – hours of use, 24 hours;
- C – safety factor, 1,3;
- t – time of low tariff, hours.

Normally, the installed output of an accumulating heating system is between: 125-200 W/m<sup>2</sup>. If the calculation reveals an installed output over 200 W/m<sup>2</sup>, the heating system should be supplemented with a rim zone heating (a smaller heating cable or mat, installed along the external walls, connected to a separate thermostat).

### Rim zone heating

Rim zone heating fulfils the following purposes:

1. In houses with large glass and door surfaces it protects against cold drafts.
2. In houses with high heat losses it functions as an additional heat source.

A rim zone area is an area where the output per square meter is increased, so more heat (higher output) is installed in the rim zone area than in the rest of the floor. This may be done by laying the cable in front of a large glass surface and decreasing the C-C distance until the required output is achieved, but observing a minimum bending radius of a heating cable. The width of a rim zone area is usually 0,5–1,5 m. The recommended output in a rim zone area is 200-250 W/m<sup>2</sup>.

Rim zone areas require separate thermostats and sensors to control them, as it is turned on only at the times, when regulator for accumulating floor heating is off.

The rim zone heating can be regulated by a thermostat with a combined room and floor sensor or a thermostat with a floor sensor alone.

As a rim zone system is a directly acting heating system, it should not be covered by more than 3 cm of concrete. Together with the high output this will ensure that it responds quickly and efficiently to temperature changes.

With regard to wooden flooring, please refer to a later paragraph about wooden floor.

### Product choice

When Danfoss's accumulating heating system is installed, the heating cables with a minimum output of 18 [W/m] should be used:

- the twin conductors heating cables ECflex 20T, ECflex 18T;
- the single conductor heating cables ECbasic 20S.

Use ECFast fitting bands to ensure a quick and easy installation or fix heating cable to reinforcing metal net installed in floor.

Alternatively, Danfoss heating mats with an output of up to 200 W/m<sup>2</sup> can also be used.

### Regulation

To control the temperature of the accumulating heating system a special thermostat should be used to save energy and regulate the floor storage heating during low tariff periods. Unit should be connected to an outdoor sensor in order to constantly measure the outdoor temperature. It needs to predict changes of weather and to generate just the required amount of heat for supporting comfort conditions during the next low tariff period. Thermostat has to be fitted with a floor sensor, for measuring the remaining heat in the floor, and limiting the floor temperature.

Regulating of accumulating floor heating can be done by a thermostat with possibility for input for electrical tariff II (low price traffic), like Danfoss Link.

Danfoss Link, with it's built-in intelligent timer, is a useful solution for regulation of accumulating floor heating.

A simpler, but less comfortable and intelligent solution can be made with EFET 130/132 (on wall mounting) or EFET 520/532 (in wall mounting), with use of external timer and connection relays. For detailed information contact your local Danfoss system provider.

### Installation

A suitable insulation should be laid below the cables according to the building standards. When the cables are laid, special care must be taken to avoid that they get into contact with the insulating material or become enveloped by it in any way.

The cables are attached to ECFast fitting bands or the steel reinforcement with help of plastic ties, with an appropriate C-C distance.

As the rim zone system is a directly acting heating system, it should not be covered by more than 3 cm of concrete. Together with the high output, this will ensure that it responds quickly and efficiently to temperature changes.

It is important that the floor construction is well insulated so the downward heat loss is kept to a minimum.

Another important element is the vertical rim zone insulation. This insulation must be efficient in order to prevent heat from being transported to the walls or adjoining rooms. Besides, it should be able to respond to the horizontal expansibility of the floor construction.

Finally, the insulation must comply with general and local regulations.

It is always advisable to install more insulation, than the minimum amount indicated by the current building requirements of your country.

## Floor surfaces

Nearly all types of floor surfaces are suited for floors in which accumulating heating has been installed. However the suppliers of the floor surface should always be consulted with regard to the temperature tolerance and the adhesives to be used. The supplier's instructions must be very carefully followed when wooden floors are laid directly on concrete constructions, in which accumulating floor heating has been installed.

Particularly important is the information about the maximum temperature tolerance of the floor surface material, that typically is set to +27 °C on the wooden floor surface.

Floor surface materials with a high insulation value, like thick wool carpets, may limit the heat distribution from the floor. In these cases, please consult the supplier of the floor surface material for further information.

### Example 1

A 13 m<sup>2</sup> office with an available floor space of 12 m<sup>2</sup> has to be heated with an accumulative heating system. The total heat loss has been calculated to 650 W. The entire low tariff period lasts for 10 hours (8 hours at night and 2 hours during the day).

1. Required installed output:  

$$\frac{650 \text{ W} \cdot 24 \text{ hours} \cdot 1,3}{10 \text{ hours}} = 2028 \text{ W.}$$
2. Choice of nearest cable: if we choose the ECflex 18T, the nearest cable is 2135 W, 118 m.
3. Calculation of C-C distance:  

$$12 \text{ m}^2 \cdot 100 \text{ cm/m} / 118 \text{ m} = 10,17 \text{ cm.}$$
 Fix the cable with help of ECfast fitting band, with a C-C distance of 10 cm.
4. Choice of thermostat:  
 The accumulating heating system should be controlled by special thermostat. As an option a timer thermostat can be selected, where timer can be turned on when low tariff is available. Alternatively an additional timer can be connected, to disconnect power to heating cable relay, in periods of high electrical tariff.

### Example 2

In this example the low tariff period lasts for 8 hours. A 26 m<sup>2</sup> storage has a usable floor space of 23 m<sup>2</sup>. The total heat loss has been calculated to 1320 W.

1. Total required installed output:
2. Choice of nearest cable:  

$$\frac{1320 \text{ W} \cdot 24 \text{ hours} \cdot 1,3}{8 \text{ hours}} = 5148 \text{ W.}$$
 The biggest ECbasic 20S is 4565 W, 228 m.  
 The chosen cable cannot provide the required output. Therefore, a rim zone

system below the windows could be a satisfactory solution. If we subtract the 4565 W from the required output (5148 W), we can calculate that the required output still exceeds the output of the cable, as we need an additional 583 W.

As the rim zone system is a directly acting heating system, as opposed to accumulating heating, the 583 W must be converted back to their original status.

This is best done by dividing the 583 W of storage heat by 3 (24 / 8 h) which means that the security factor is still included in the final result. 583 W / 3 = 194 W of directly acting heat.

If we choose the ECflex 18T, the nearest cable is 270 W, 15 m.

3. Calculation of C-C distance:  

$$23 \text{ m}^2 \cdot 100 \text{ cm/m} / 228 \text{ m} = 10 \text{ cm.}$$
4. The C-C distance of the rim zone. If the area of the rim zone is 0,5 m · 2,4 m = 1,2 m<sup>2</sup>, this gives a C-C distance of:  

$$1,2 \text{ m}^2 \cdot 100 \text{ cm/m} / 15 \text{ m} = 8 \text{ cm.}$$
5. Choice of thermostat:  
 in this example, the accumulating heating system should be controlled by a special thermostat. The rim zone can be controlled by any timer Danfoss thermostat.

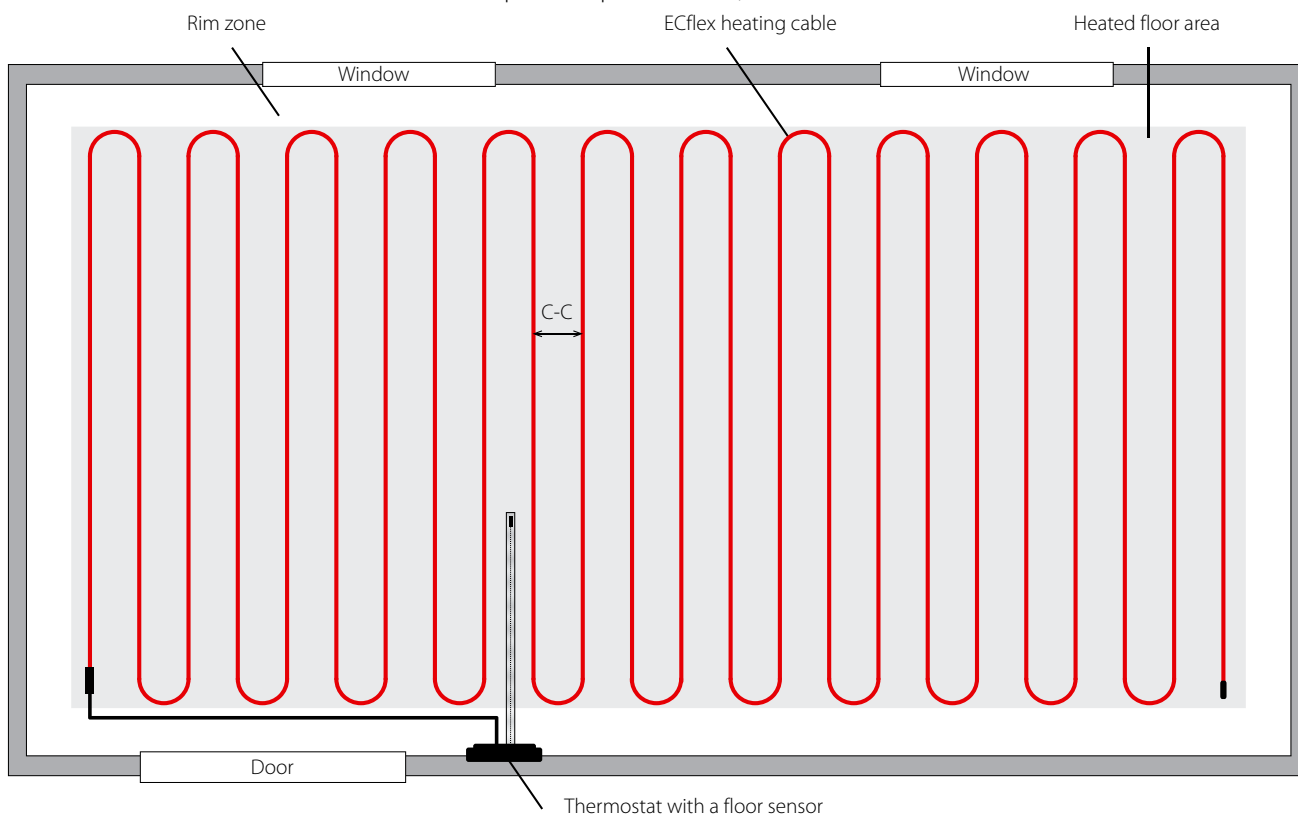

Fig. 3. Example of Accumulating heating system.



## 5. Electrical heating system floor constructions

Danfoss designs and produces heating equipment: cables, mats, heating elements, thermostats, fixings, to fulfill installation requirements for the following, most common floor constructions:

1. Thick (>3 cm) concrete floor construction;

- Thin (<3 cm) floor and similar floor constructions;
- Wooden floors:
  - wooden floor on joists;
  - floor with wooden surface and concrete or wooden subfloor;
  - ECdry – special heating elements/mats for dry installation under laminate

- Reflect insulation plates (EFCI Dry) – heating system with heat distribution plates under laminate.

All these floor constructions and heating equipment for them are described in chapters below.

### 5.1. Cable heating in thick concrete floor construction

Most used floor construction is where heating element is installed in concrete. Heating cables, or mats are embedded in layer of concrete and normally placed in the lower part of a finish (top) layer of concrete. For Direct Floor Heating and Comfort Floor Heating systems typical thickness of concrete, above the cables, is: 3-7 cm. For Accumulating Heating system, heating cables are usually embedded in a thick layer of concrete: 7-15 cm.

Building norms usually limit the minimum thickness of finish concrete layer to 3-4 cm, due to mechanical integrity of the floor (follow local norms). This limitation is independent of installation of a heating cable in the floor. Always strictly follow the specific norms and regulations concerning the floor constructions applicable in your country.

**Recommendation:** install heating cables not far from floor surface (approx. 3-5 cm below), it gives improved reaction time for controlling the system. However secure that the C-C distance between cables is not bigger than 2x (two times) the thickness of concrete above the heating cables, and there is a sufficient insulation installed below the heating element. Otherwise a floor surface can develop cold areas, and will not feel comfortable for the user.

#### C-C distance.

For Comfort Floor Heating System one of the main demands is to support uniform/comfort temperature distribution on the floor surface (see chapter 4.1). To ensure this, the C-C distance for heating cable installed into concrete slab with thickness 3 cm or more, should be recommended

5-15 cm and preferred is 10 cm or less. The C-C distance for thin floor constructions with thickness less than 3 cm (concrete, self-leveling, glue, etc.) should be no wider than 10 cm and is recommended to be even less: 7,5 cm. Amount of insulation in the floor, as well as other thermal conditions of installation (like e.g. installation over a heated room), play also an important role in stable surface floor temperature.

For Direct Floor Heating system is less sensitive to uniform comfort

temperature distribution on the floor surface (see chapter 4.2).

The C-C distance depends primarily on heat loss, which is small for modern premises, e.g. 30-60 W/m<sup>2</sup>. This leads to rather big distances, for example, C-C = 30-50 cm. This resembles situation described for Accumulating Floor Heating system (see chapter 4.3).

### Benefits

- **Optimal comfort.**
- **Warm feet.**
- **Freedom of design.**
- **Easy installation.**
- **Under any top flooring.**
- **High durability, no maintenance.**
- **Total heating without any radiators.**
- **Control your electrical heating systems from a distance**
- **Central Controller for combined control of both radiator heating and floor heating**

## Installed output

### Thick concrete floors with thickness of 3 cm or more.

The recommended maximum cable linear output is 20 W/m. It should be noted that some local regulations specify lower values and should be followed strictly. For lower cable temperatures, and an improved thermal division of heat over the whole surface of the floor, Danfoss advises to use cable with lower linear output, e.g. 10-18 W/m, or even 6 W/m for low energy houses.

Maximum specific output in this concrete floor construction is allowed to be 200 W/m<sup>2</sup>.

### Concrete floors with thickness less 3 cm.

The recommended maximum cable linear output is 20 W/m. For lower cable temperatures and resulting longer cable life time, it is preferable to use cable with lower specific output, e.g. 10-15 W/m.

Specific output in this concrete floor construction must not exceed 200 W/m<sup>2</sup>.

### Concrete floors with wooden surface (laminat, multi-layer boards, parquet, etc.).

Specific output in this concrete floor construction has to be maximum 150 W/m<sup>2</sup>, but for some applications as low as 100 or even 55 W/m<sup>2</sup>. If floor construction is without insulation: heat loss down has to be evaluated, and specific output should be increased to match the heat loss value.

Floors with wooden surface are always limited with a floor temperature, allowing a maximum surface temperature of floor surface of 27 °C. We advise always to use a thermostat with, beside room sensor, wire floor sensor for installations with wooden floor.

More detailed information about wooden floor is available in part 5.3 of this compendium.

**Note.** Heating cables can be installed in wall and ceiling construction too. For such type of applications cable with specific output of maximum 20 W/m and surface specific output of

maximum 100 W/m<sup>2</sup> is advisable.

In such applications always contact Danfoss as special care must be taken for designing and installing of such systems.

### Product choice

When heating system is installed in concrete floor following Danfoss screened heating cables can be recommended:

- twin conductor heating cables: ECflex 20T, ECflex 18T, ECflex 10T;
- single conductor heating cables: ECbasic 20S.

**Note.** The number in a cable's name is its specific output, e.g. 18T means a linear output of 18 W/m at 230 V, T means twin conductor.

It should be noted that it is also possible to use thin heating mat in thicker concrete floor types.

Heating in floor is independent of the thickness of the heating element (cable or mat), but depends on specific output of area (in [W/m<sup>2</sup>]).

### Fixing

For the installation of heating cables we recommend the use of ECfast metal fitting band with possibility for fixing of heating cables for every 2,5 cm. Alternatively plastic fitting bands can be used. Another alternative: the heating cables can be attached to concrete armoring (metal mesh embedded in concrete), with help of special plastic cable ties used for quick and easy installation. Additional information about products for installation are found in Danfoss Product Catalogue.

### Thermal insulation

It is important that the floor construction is well thermally insulated, in accordance with general and local building regulations and standards. Aim is to keep the downward heat loss to a minimum. Otherwise downward heat loss down has to be evaluated and decision for correct additional output has to be done. New build houses follow the modern building requirements, and insulation below a floor construction is standard.

Renovations, however, can be a different case, and here an extra effort should be undertaken to clarify presence of insulation, if it is lacking, it's strongly advisable to, at least install Reflect insulation plates (EFCI Dry), with 12 mm insulation and heat distributing aluminum layer. Even a smaller amount of insulation is better than none.

It should be observed that heating cable must not get into direct contact with the insulation. Otherwise working temperature of it can become too high, which might result in cable defects at worst. Direct contact with insulation can be avoided by laying a separating layer, for physical separation and prevention of embedding of cable into insulation, onto insulation. For example, such separating layer can be in form of:

- thin concrete covering,
- aluminum (with PE sheet) or thick plastic foil, allowed to be used in contact with electrical heating cables,
- wire mesh netting with a diameter of 1-2 mm, and mesh size of max. 2x2 cm.

Another important element of insulation, is the vertical insulation near outside walls, which are not properly insulated. This insulation must be efficient in order to prevent heat being transported outside. Additionally it should be able to respond to the horizontal expansion of the floor construction.

### Floor surfaces

Nearly all types of floor surfaces are suited for floors in which heating cables have been installed, but the supplier of the floor surface should always be consulted.

The supplier's instructions must be very carefully followed when wooden floors are installed above floor heating. For further information about heating with wooden floors, please refer to the relevant paragraph later in this document.

Flooring materials with a high insulation value, like thick wool carpets, can limit the heat distribution from the floor. In these cases, please consult the supplier of the flooring material for further information.

The maximum value of the thermal resistance for the floor top layer material should not exceed 0,125 m<sup>2</sup>·K/W.

Flooring materials suitable for floor heating will be fitted with following mark:

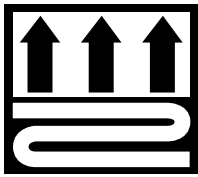

### Installation and floor construction

Floor construction has to be done according to the building standards. Generally a floor construction with electrical heating element (cable or mat), installed in a concrete layer, does not have any special demands and restrictions.

It is advisable however to install a dampening layer in vertical parts of floor slab, adjacent to walls (and especially external walls), of e.g. soft tape min. 5 mm thick, thin thermal insulation or alike. It gives possibility to respond to the horizontal expansibility of the floor construction and to prevent cracking of the floor.

The need for reinforcement of floor construction should be fulfilled according to local building norms.

Minimum cable-to-cable distance is based on cables outer diameter, and it is 6x its diameter. Practically it means ~5 cm between any two cable lines.

For additional installation instructions, please refer to the Appendix A.4 "General installation guide" and relevant heating cable/mats/elements installation instructions.

Concrete floor constructions with cable heating system and different types of fixing are shown on figure below.

- 1 – Thermostat
- 2 – Tiles
- 3 – Tiles glue for heated floors
- 4 – Primer
- 5 – Finish/top layer of concrete
- 6 – Conduit plastic tube for sensor (sealed at the end)
- 7 – ECfast fitting band
- 8 – Connection cable and muff
- 9 – End muff
- 10 – Twin conductor heating cable
- 11 – Separating layer e.g. thin concrete covering
- 12 – Thermal insulation
- 13 – Concrete base

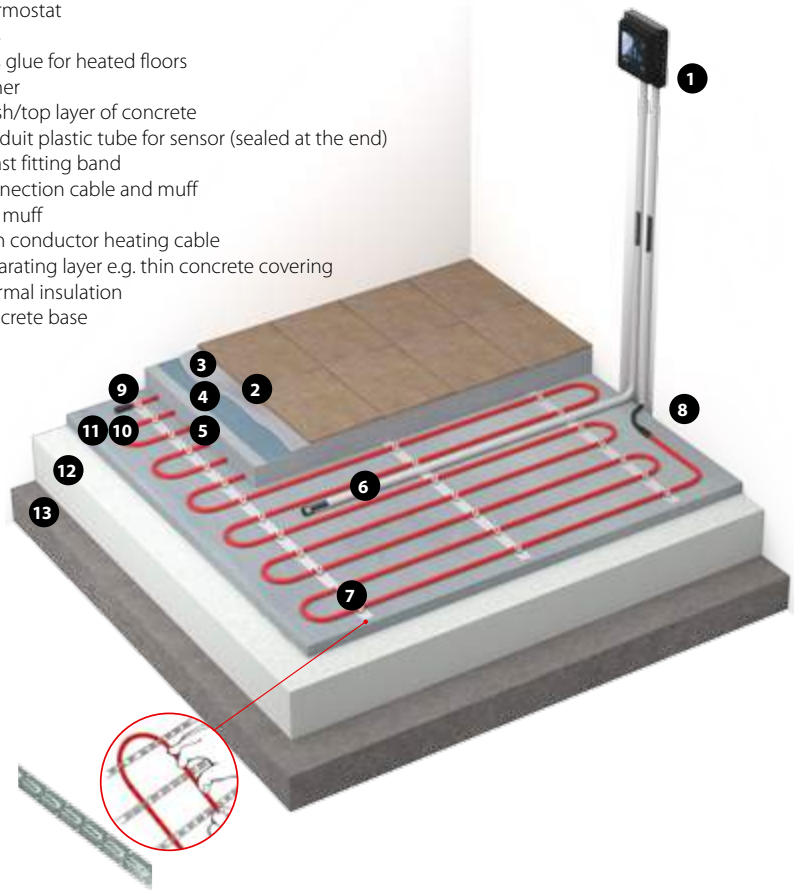

Fig. 4. Cable heating in concrete floor with cable fixed by ECfast fitting band.

- 1 – Flooring
- 2 – Adhesive
- 3 – Damp proofing (wet room), primer
- 4 – Finish/top layer of concrete
- 5 – Conduit tube for floor sensor
- 6 – Heating cable
- 7 – Reinforcing mesh
- 8 – Plastic cable ties
- 9 – Spacer for reinforcing mesh
- 10 – Thermal insulation
- 11 – Leveling layer
- 12 – Concrete base

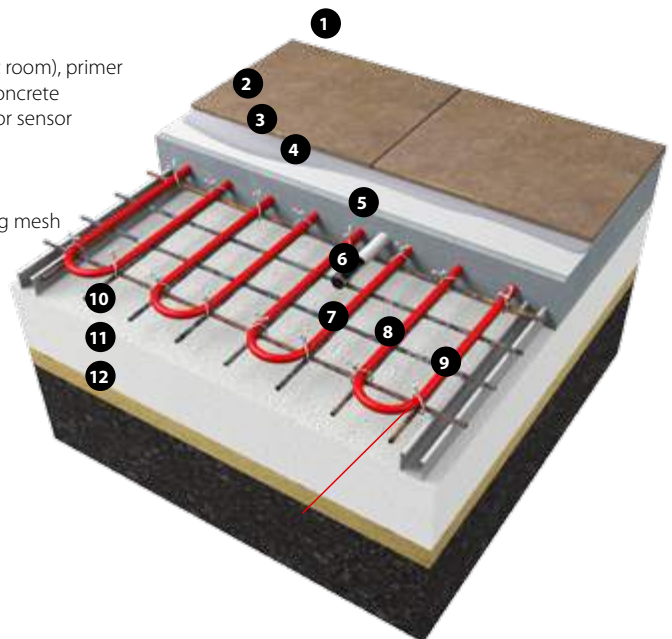
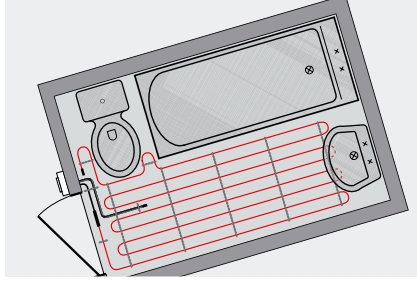

Fig. 5. Cable heating in concrete with cable fixed to reinforcement mesh by plastic cable ties.

## Installation steps for cable heating system in concrete



1. Cable heating system: heating cable, thermostat with floor temperature sensor, fitting band, conduit pipe.



2. Draw a plan in order to position heated area, cable, cold tail, floor sensor, thermostat and connection box, if any.

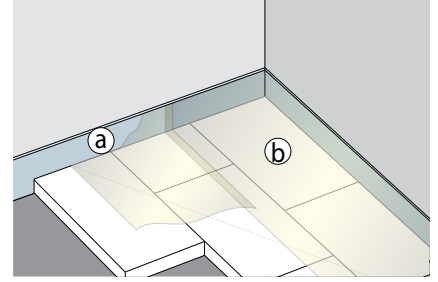

3. Install insulation: deformation tape (a), thermal insulation (b).

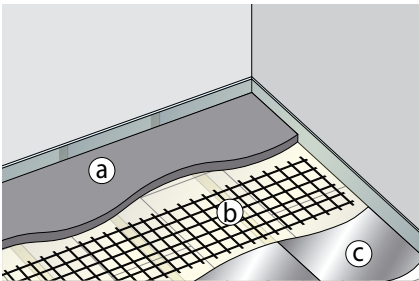

4. Install separating layer, e.g. concrete (a), metal mesh (b) or aluminum foil (c).

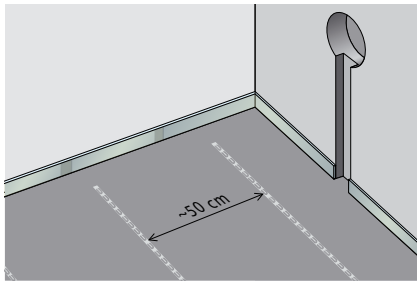

5. Fasten ECfast fitting bands in 50 cm distance (by nails, screws, dowels, hot melt glue etc.).

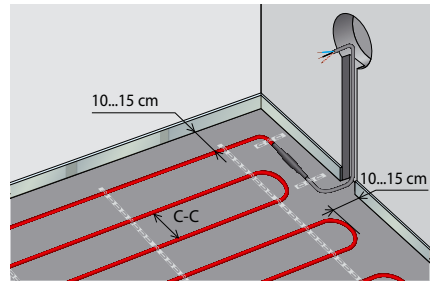

6. Check resistance and insulation values of cable. Install heating the heating cable: app. 10-15 cm from the walls. For comfort heating preferred C-C = 7,5 cm.

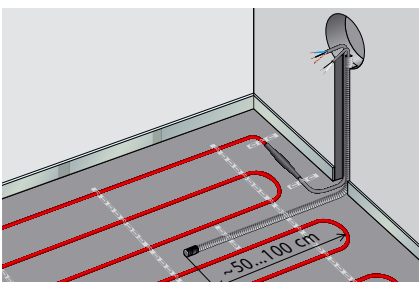

7. Install conduit pipe for floor sensor (must be sealed at the end installed in concrete). Check resistance of sensor before installing in pipe.

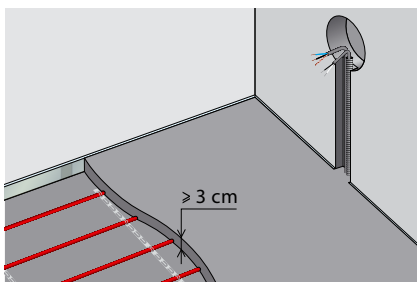

8. Check resistance and insulation values of cable and sensor. Apply concrete.

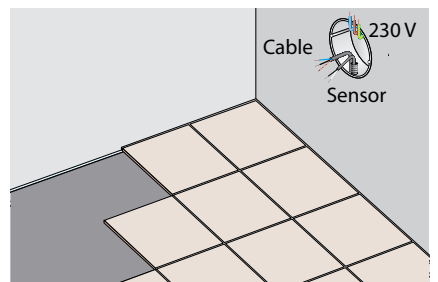

9. Check resistance and insulation values of cable and resistance of sensor. Install flooring and connect thermostat.

Additionally check with Installation Instructions included together with every element of a heating system (cable, mat and thermostat).

Cable must be attached to a floor foundation very securely to prevent its movement in the further process of concrete layout. Generation of air pockets, during the layout process of concrete around the cable, must be prevented.

It is forbidden for heating cable lines to touch, or cross each, failure to comply with that important rule will overheat a cable and lead to a fault at later date!

## 5.2. Electrical heating system in thin floor construction

Danfoss has designed a special heating system: thin heating mats, for application where the construction height of the floors needs to be low. Thin heating mats require a height of approx. 3-4,5 mm, which is less than layer's height of most used tiles glue (adhesive, self-leveling compound) materials. The thin heating mats can be installed on the existing tiles, wooden floors or concrete floors. It is required that the underconstruction is free of mechanical or thermally induced movement and any sharp objects. Typical areas of use are kitchens and bathrooms, but the thin heating system can be used anywhere in a house or apartment.

A heating cable is also applicable for installation into thin floor construction. But the construction height is higher, than of mat, because of fixing type, and heating cables usually have larger diameter (maybe even as much as double of the mat).

The heating cable application requires a minimum height of approx. 1-2 cm, and it's not advisable for thin floor installations.

To achieve a comfortable temperature on top of the new floor, with thin floor construction, a buildup of the floor needs to be reviewed, especially in regard to insulation. Insulation under electrical floor heating is always strongly advisable, and lack thereof can lead to unsatisfactory surface temperatures for heating system in thin floor construction. Always follow building regulation in your country, and in case of doubt, don't hesitate to contact Danfoss representative.

### C-C distance.

For Comfort Floor Heating System one of the main demands is the support of uniform/comfortable temperature distribution on the floor surface (refer chapter 3.1. "Comfort Floor Heating"). To ensure this, the C-C distance for thin floor constructions with thickness less than 3 cm has to be no wider than 10 cm and is recommended to be less: 7,5 cm (or even 5 cm).



## Benefits

- Warm feet.
- No breakup of the old floor.
- Freedom of design.
- Easy and quick installation.
- Under any top flooring.
- Building height increase by only 3-5 mm.
- Quick responding floor heat.
- Reduce heat loss.
- Total heating without any radiators.
- Precise and energy saving regulation.
- Control your electrical heating systems from a distance
- Central Controller for combined control of both radiator heating and floor heating

As Direct Floor Heating System does not strictly require a uniform floor temperature, it is still desired (see chapter 3.2).

However, as insulation is always installed in new installations, the C-C distance, is more dependent on heat loss, and any needed value is possible. It is advisable however to keep the C-C distance, in this application, below 15 cm.

### Installed output

#### Thin glue/adhesive, self-leveling compound, etc. floors with thickness less than 3 cm.

Heating cables/mats with maximum specific output 20 W/m have to be used. All Danfoss thin heating mats fulfill this condition.

Specific output in this floor construction has to be maximum 200 W/m<sup>2</sup>, usually between 100-150 W/m<sup>2</sup>.

#### Thin floors with wooden surface (laminated, multi-layer boards, parquet, etc.).

Heating cables/mats with specific linear output of maximum 10 W/m, are allowed.

Specific output in this concrete floor construction is allowed to be maximum 100 W/m<sup>2</sup>. But here floor has to be thermal insulated enough to prevent significant heat loss down. If floor is without insulation: heat loss down has to be evaluated and specific output should be considered.

More detailed about wooden floor can be found in chapter 5.3.

#### Floor with wooden sub flooring.

If heating mat/cable is installed onto wooden subfloor, norms and regulations limiting maximum cable specific output to 10 W/m.



Specific output in this floor construction should be maximum  $55 \text{ W/m}^2$ . It should be noted that  $55 \text{ W/m}^2$  can heat  $1 \text{ m}^2$  of floor maximum up to  $5 \text{ }^\circ\text{C}$  only, in relation to air temperature. It has to be evaluated, for each specific case of that type, if this output level is satisfactory for direct heating system.

More details about wooden floor are found in chapter 4.3.

**Note.** Thin heating mats/cables can be installed in wall and ceiling construction too. In such case it is recommended to use the heating element with specific output of maximum  $20 \text{ W/m}$  and surface specific output of maximum  $100 \text{ W/m}^2$ .

### Product choice

When heating system is installed in thin floor following Danfoss thin screened heating mats can be recommended:

- twin conductor  $\sim 3,5 \text{ mm}$ :  
ECmat 100T,  
ECmat 150T;
- twin conductor  $\sim 4 \text{ mm}$ :  
ECcomfort 100T;
- single conductor  $\sim 3 \text{ mm}$   
EHeat 150S.

The width of mat covers  $\sim 50 \text{ cm}$  while the length ranges usually from  $1$  to  $24 \text{ m}$  ( $0,5\text{-}12 \text{ m}^2$ ).

If the floor height is not crucial, Danfoss screened heating cables of max.  $10 \text{ W/m}$  can be recommended:

- twin conductors heating cables  
ECflex 10T.

**Note.** The number in a cable's name is its specific output, e.g. 10T mean  $10 \text{ W/m}$  at  $230 \text{ V, T}$  – twin conductor.

More information about heating mats and cables can be found in chapter 3 and 4 of this manual or in Danfoss Product Catalogue and Installation Instructions.

### Fixing

For the installation of thin heating mats onto subfloor no fixing is needed. Mats have self-adhesive glass fiber mesh which is designed for quick and safe installation.

For the installation of heating cables we recommend the use of ECfast metal fitting band with possibility of C-C distance of  $2,5 \text{ cm}$ . It is also possible to attach the cables directly to foundation with a glue gun, but observe the maximum temperature, that cables can be subjected to.

Mats and cables must be installed securely to prevent its moving during the installation. It is forbidden for lines of heating cable to touch or cross each other. Failure in strictly following this rule will result in cable overheating and a likely fault of the installation.

### Thermal insulation

It is important that the floor construction is well thermal insulated, according to local building regulations and standards. So the heat loss downward is kept to a minimum. Otherwise heat loss down has to be evaluated and decision for correct additional output has to be made.

It should be noted that heating cable must not get into direct contact with the insulation. Otherwise temperature can become too high, which might result in cable defect over time.

Vertical insulation is also an important element of an installation, and it should be installed near outside walls which are not properly insulated. This insulation must be efficient in order to prevent heat being transported to outside. Besides, it should be able to respond to the horizontal expansibility of the floor construction.

### Floor surfaces

Nearly all types of floor surfaces are suited for floors in which heating mats/cables have been installed, but the supplier of the floor surface should always be consulted.

Cables must be covered with at least  $20 \text{ mm}$  of glue, adhesive, concrete, etc. if the covering material consists of wood or plastic.

The supplier's instructions must be very carefully followed, when wooden floors or thick wool carpets are installed directly on concrete constructions in which floor heating has been installed. These materials limit the heat distribution from the floor. In such cases a thermostat included a floor temperature sensor has to be used. For further information about heating in wooden floors, please refer to the relevant paragraph of this document, or contact the floor supplier.

Flooring materials with a high insulation value, like thick wool carpets, can limit the heat distribution from the floor. In these cases, please consult the supplier of the flooring material for further information.

The maximum value of the thermal resistance for the floor above heating elements should not exceed  $0,125 \text{ m}^2\text{K/W}$ .

Keep a minim air gap of  $5 \text{ cm}$  beneath permanent objects like cabinet, desk, beds, etc.

### Installation and floor construction

Floor construction has to be done according to the local building standards. In thin floor construction with heating element placed into glue, adhesive, or alike, no special demands and restrictions are needed. The glue, adhesive, or alike has to be designed by the manufacturer for use with heated floor construction.



As damping layer installed in vertical parts (ends) of floor slab it is advisable to install a special soft tape minimum 5 mm, e.g. thin thermal insulation or alike. It gives possibility to respond to the horizontal expansibility of the floor construction and to prevent its cracking.

Distance of min. 3-5 cm between any two cable lines or nearby mats is recommended.

It is very important to choose a mat with the right dimensions, little smaller than available floor installation area, since the mat cannot be shortened.

For additional information about installation, please refer to the Appendix A.4 and relevant heating cable/mats/elements installation instructions.

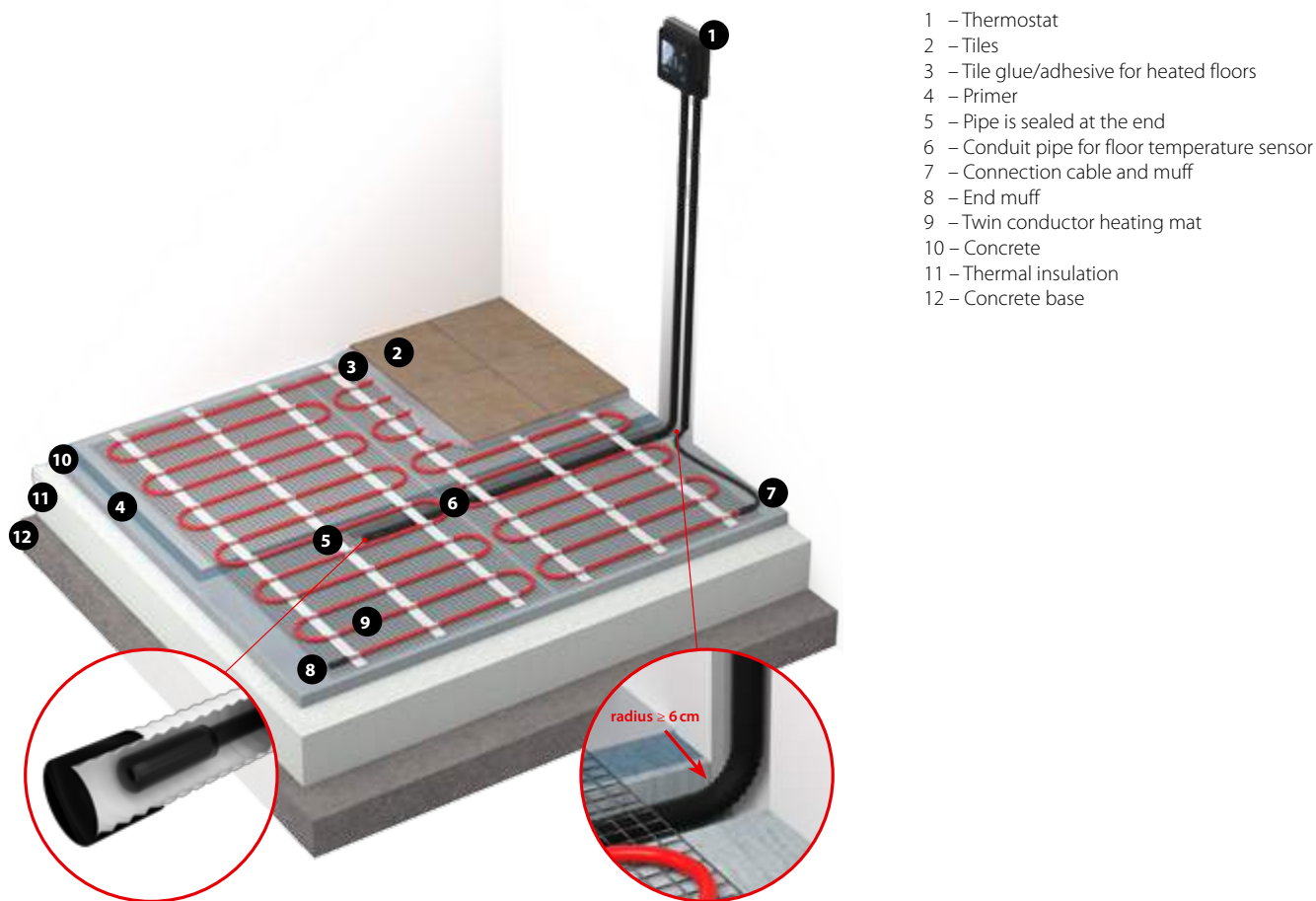

- 1 – Thermostat
- 2 – Tiles
- 3 – Tile glue/adhesive for heated floors
- 4 – Primer
- 5 – Pipe is sealed at the end
- 6 – Conduit pipe for floor temperature sensor
- 7 – Connection cable and muff
- 8 – End muff
- 9 – Twin conductor heating mat
- 10 – Concrete
- 11 – Thermal insulation
- 12 – Concrete base

Fig. 6. Thin floor construction with twin conductor thin heating mat

## Installation steps - thin heating mat in tile glue



1. Heating system with thin mat: heating mat, thermostat with floor temperature sensor, con-duit pipe.



2. Check/draw a plan in order to position heated area, mat, cold tail, floor sensor, thermostat and connection box, if any.



3. Make a groove for the sensor conduit pipe and cold cable.



4. Install conduit pipe for floor sensor (must be sealed at the end). Check resistance of sensor before installing in pipe. Install wire sensor in pipe.



5. Check resistance and insulation values of the mat. Roll out the heating mat from thermostat position. Attach it to the sub floor.



6. Cut and turn the mat mesh when meeting walls or obstacles. DO NOT CUT the cable.



7. Install the heating mat avoiding obstacles, future objects fixed to the floor, etc. Min. 3 cm between any two cable lines.



8. Install mat on the entire surface. App. 3-4 cm between nearby mats. Check resistance and insulation values of mat and resistance of sensor.



9. Apply tile glue and Install tiles. Check resistance and insulation values of mat and resistance of sensor.

Additionally: follow Installation Instruction for heating cable/mat and thermostat, included with every product.

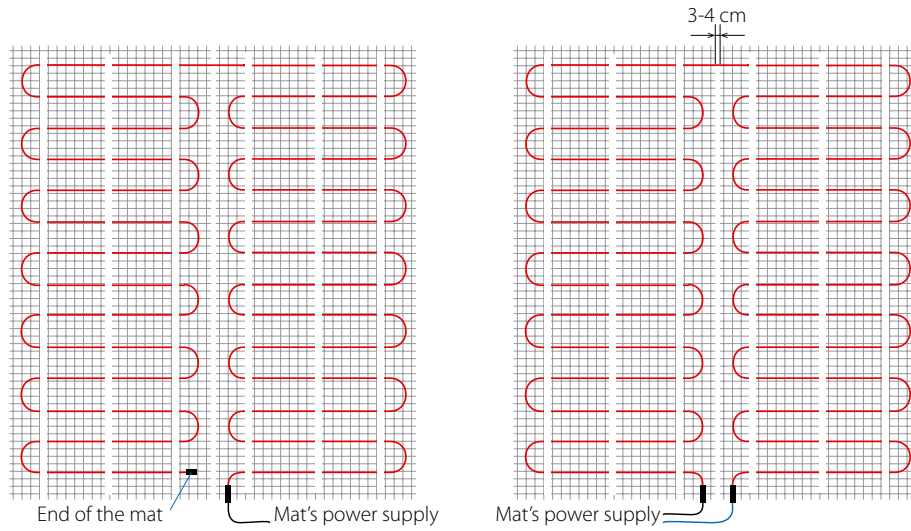

Fig. 7. Example of layout of a twin and single conductor heating mat.

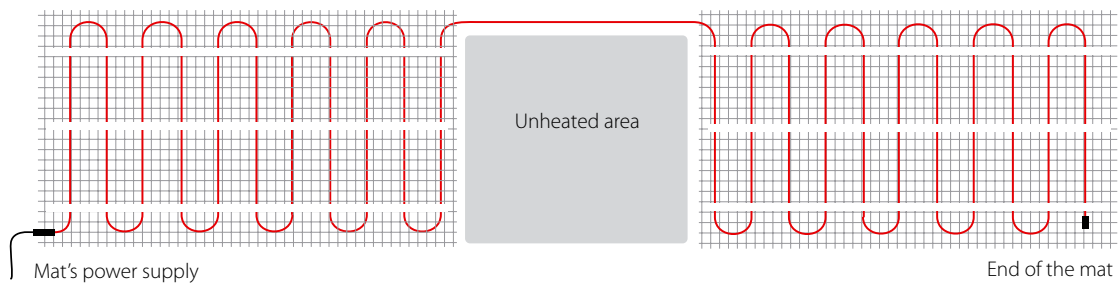

Fig. 8. Layout for a mat around an unheated area / obstacle.

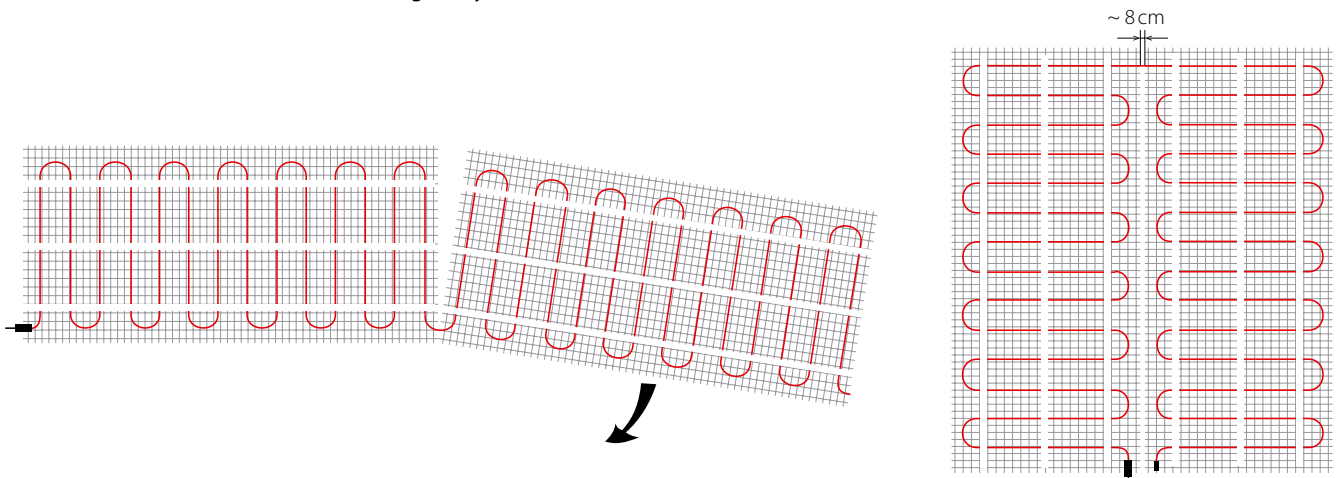

Fig. 9. The heating mats can be very easily adapted to the shape of the heated surface.  
Example above: placing ECmat 150T 50 x 300 cm on 100 x 150 cm.

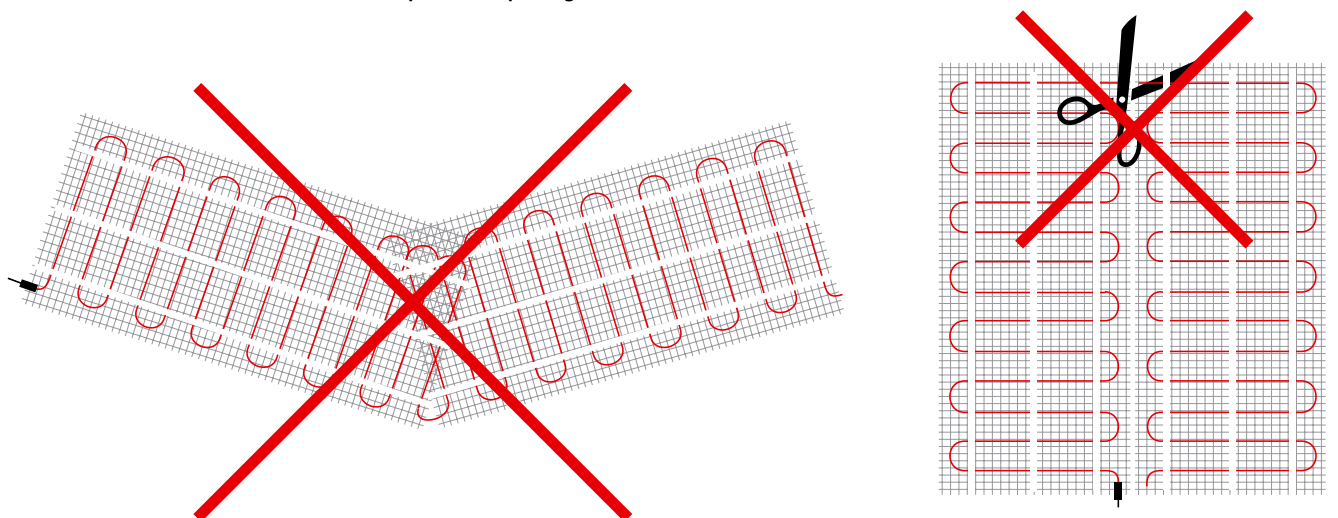

Fig. 10. Never cross or cut cable on the heating mat.

## 5.3. Heating in wooden floors

Danfoss heating system can be installed in all kinds of wooden floors, as long as the installation requirements are observed and followed. Danfoss produces heating equipment: cables, mats, heating elements, thermostats, fixings, etc. for the following most common wooden floor constructions:

- wooden surface on concrete or wooden subfloor;
- wooden floor on joists;
- ECdry – special heating elements/mats for dry installation under laminate etc.;
- Reflect insulation plates (EFCI Dry) – heating system with heat distribution plates for dry cable installation under laminate etc.

All this floor constructions and heating equipment are described in chapters below.

### Temperature limitation

When heating is installed in wooden floors on concrete or on existing wooden floors, the surface temperature of the wooden floor should not exceed level that the manufacturer of the floor surface has recommended. Usually the manufacturers' maximum limit of surface temperature is 27 °C.

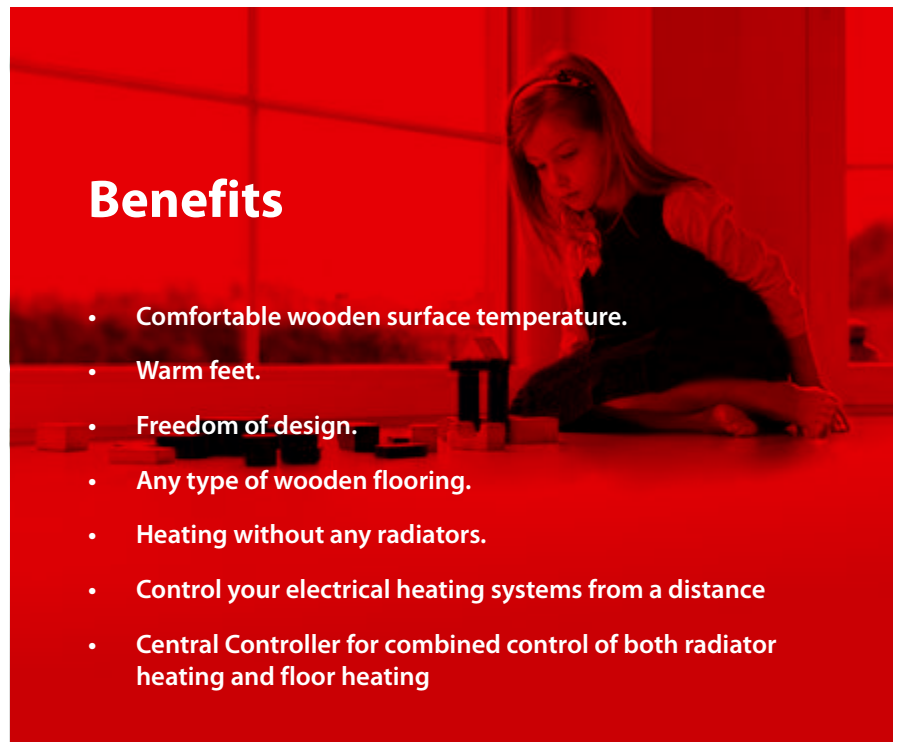

## Benefits

- **Comfortable wooden surface temperature.**
- **Warm feet.**
- **Freedom of design.**
- **Any type of wooden flooring.**
- **Heating without any radiators.**
- **Control your electrical heating systems from a distance**
- **Central Controller for combined control of both radiator heating and floor heating**

**Recommendation:** a floor sensor should always be used in order to control the temperature in the floor. The floor sensor has to be connected to the electronic thermostat with the temperature limiting feature. As an extra safety factor, the thermostat should disconnect the heating system, if the sensor has failed.

According to ISO 13732-2, the comfortable floor surface temperature depends on the flooring material. But for all wooden floorings maximum value of comfortable floor surface temperature is 27 °C.

All floor temperature settings for sensor installed in floor construction must be a few degrees higher to compensate for the heat resistance in the floor covering.

Approximate thermal resistance, m <sup>2</sup> ·K/W	Examples of flooring	Details	Approx. setting/limitation for 27 °C floor surface temperature
0,05	8 mm HDF based laminate	>800 kg/m <sup>3</sup>	30 °C
0,10	14 mm beech parquet	650 - 800 kg/m <sup>3</sup>	33 °C
0,13	22 mm solid oak plank	>800 kg/m <sup>3</sup>	35 °C
<0,17 max	Max. carpet thickness suitable for floor heating	Acc. to EN 1307	36 °C
0,18	22 mm solid fir planks	450 - 650 kg/m <sup>3</sup>	37 °C

The floor temperature must be increased slowly during the first week after installation to allow the new floor to settle. This is also recommended at the beginning of a heating season.

depending on the relative humidity (RH) in the room. The optimal range is 30-60% RH and must never be lower than 30%.

The heating system shall be designed so that it gives a very uniform surface temperature over the whole floor area, with evenly spaced heating elements (cables or mats).

Wood shrinks and swells naturally,

### Installed output

There are few limitations to be observed when installing floor heating in conjunction with the wooden floors, like:

1. The installed output in wooden floors with wooden subfloor must not exceed 55 W/m<sup>2</sup>.
2. The installed output in wooden floors on joists must not exceed 80 W/m<sup>2</sup>.
3. The installed output in tile floors lying on wood must not exceed 100 W/m<sup>2</sup>.
4. The installed output in thin floor (thickness <3 cm, e.g. mats in tile glue) must not exceed 100 W/m<sup>2</sup>.
5. The installed output in thick concrete floor (thickness >3 cm) must not exceed 150 W/m<sup>2</sup>.

If heating element (mat or cable) is installed just onto a wooden subfloor, norms and regulations limit maximum cable specific output to 10 W/m.

It should be noted that 55 W/m<sup>2</sup> can heat 1 m<sup>2</sup> of floor surface maximum up to app. 5 °C in relation to air temperature (see chapter 4.1.1). For example, if air temperature is 18 °C, possible max surface temperature is 18 + 5 = 23 °C.

Sometimes it is not enough to provide a feeling of comfortable warm. In such case output of 55 W/m<sup>2</sup> has to be evaluated for possibility to reach demanded floor surface temperature.

For Direct Heating system, if an installed maximum output does not fulfill the specific heat loss (in [W/m<sup>2</sup>]), an additional heating system has to be installed to ensure a required room temperature in the coldest days of a year.

### Types of floor surfaces

Danfoss's floor heating systems may be used in connection with all known types of wood, both as plank or laminated. It is important that the manufacturer's recommendations for maximum temperatures are carefully followed.

Avoid Beech and Maple in multilayered constructions unless press dried.

The maximum value of the thermal resistance for the floor structure above cable should not exceed 0,125 m<sup>2</sup>·K/W.

With regards to the thickness of the wooden floor, floor heating should only be installed if:

1. The maximum thickness of soft wood (density 400-600 kg/m<sup>3</sup> – pine etc.) is ≤ 2 cm.
2. The maximum thickness of hard wood (density over 600 kg/m<sup>3</sup> – oak etc.) is ≤ 3 cm.

Keep an air gap of minimum 5 cm under objects like: cabinet, desk, bed, etc. And do not install the floor heating element under furniture preventing air movement under it.

Wooden floors shall always be protected against moisture from the subfloor. If a wooden floor is installed over underfloor heating, there shall always be a vapor barrier in the construction as close to the wooden floor as possible. If the relative humidity in the foundation exceeds 95%, a vapor barrier is not sufficient; a damp proof membrane must then replace it.

The supplier of the wooden floor should be informed that heating is being installed, so the right type of adhesive is used etc. The floor manufacturer's recommendations regarding the installation of floor heating under wooden floors should always be followed.

### Product choice - control

The electronic thermostats with floor sensor, for limitation of floor temperature, must to be chosen.

Danfoss thermostats are pre-set with a max. floor temperature of 35 °C.

If a higher value is necessary, and allowed to be used by a wooden floor manufacturer, get in contact with your local Danfoss solution provider.

### Installation and floor construction

Ensure that the temperature in the floor construction and chosen output [W/m<sup>2</sup>] always corresponds to the tolerance level that the manufacturer of the floor surface has recommended.

Always install a floor sensor to limit the floor surface temperature.

Some suppliers have certain requirements regarding the start up of a heating system under wooden floors. For example before the wooden floor is laid:

- The floor heating system must have been switched on for at least 3 weeks.
- The system must have been working under max. output for 4 days.
- After the wooden floor has been installed, the concrete temperature must be below 18 °C.
- The floor temperature must be increased slowly during the first week. This is also recommended in the beginning of a heating season.

It is always advisable to train the end-user or daily supervisor in the operation of the heating system.



### 5.3.1. Wooden floor on concrete or on thin floors

Thick concrete floor and thin floor are the most used floor constructions. Cable heating systems for these floors are mostly used for Comfort Floor Heating and Direct Heating. Wooden surface can be used as top layer of floor, for those systems and its constructions are described in chapter 4.1 and 4.2.

#### Installed output

When heating is installed in wooden floors on concrete, few limitations should be observed

1. The installed output in thin floor (thickness <3 cm, e.g. mats in tile glue) must not exceed 100 W/m<sup>2</sup>.
2. The installed output in thick concrete floor (thickness >3 cm) must not exceed 150 W/m<sup>2</sup>.
3. The specific output of heating cables/mats must not exceed 20 W/m.

#### Floor surfaces

Danfoss floor heating systems may be used in connection with all known types of wood floorings, both in plank and laminated form. It is important that the wooden floors manufacturer's recommendations are carefully followed.

With regards to the thickness of the wooden floor, floor heating should only be installed/used if:

1. The maximum thickness of soft wood (density 400-600 kg/m<sup>3</sup>: pine etc.) is ≤ 2 cm.
2. The maximum thickness of hard wood (density over 600 kg/ m<sup>3</sup>: oak etc.) is ≤ 3 cm.



## Benefits

- **Wooden surface up to 30 mm.**
- **Easy to install.**
- **Freedom of design.**
- **Warm feet.**
- **Output up to 150 W/ m<sup>2</sup>.**
- **Comfort floor heating.**
- **Total heating without any radiators.**
- **Control your electrical heating systems from a distance**
- **Central Controller for combined control of both radiator heating and floor heating**

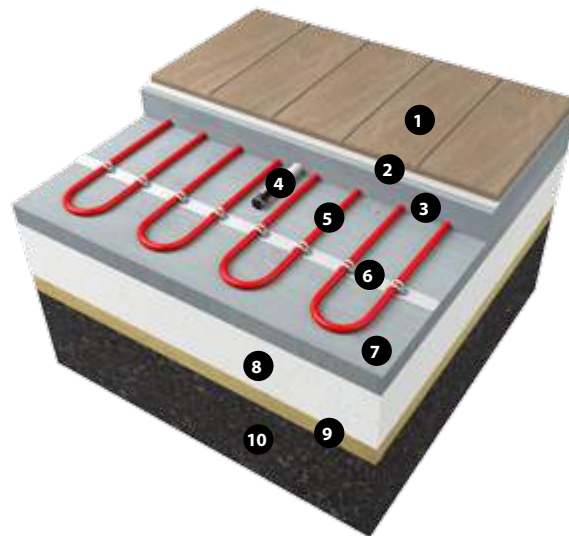

- 1 - Wooden top flooring
- 2 - Noise insulation + vapor barrier
- 3 - Concrete
- 4 - Conduit pipe with wire sensor
- 5 - Heating cable
- 6 - Fitting band ECfast
- 7 - Concrete separating layer
- 8 - Insulation
- 9 - Capillary-breaking layer, concrete, etc.
- 10 - Soil

Fig. 11 – Wooden floor on concrete

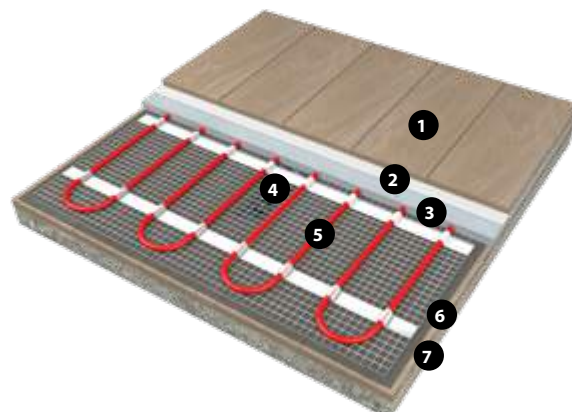

- 1 - Wooden floor
- 2 - Noise insulation + vapor barrier
- 3 - Self-leveling compound
- 4 - Temperature sensor (in a sealed tube)
- 5 - Heating mat
- 6 - Damp proof membrane/primer
- 7 - Floor base

Fig. 12 – Wooden floor on thin floor



### 5.3.2. Wooden floor on joists

In wooden floor on joists, electrical heating can be added within existing construction height. The heating cable/mat is installed on mesh netting (or chicken wire), which is placed between joists under wooden planks.

#### Installed output

When heating is installed in wooden floors supported by joists few limitations should be observed:

1. The installed output must not exceed 80 W/m<sup>2</sup>.
2. The specific output of heating cables/mats must not exceed 10 W/m.

#### Product choice

When cable heating system is installed in wooden floor on joist constructions following Danfoss heating cables can be recommended:

- twin conductor heating cables ECflex 10T;

For regulation a thermostat with floor sensor must always be used, with the ability to limit the maximum floor temperature.

For more information about heating mats/cables, see chapter 3 or Danfoss Product Catalogue and Installation Instructions.

#### Thermal insulation

It is important that the floor construction is well thermally insulated, according to general and local building regulations and standards. In this way heat loss downward is kept to a minimum.

Otherwise heat loss down has to be evaluated and decision for correct additional output has to be made.

It should be noted that heating cable must not get into direct contact with the insulation. To avoid this contact, fine mesh netting (chicken wire, reinforced mesh, etc.) or heat leading foil, can be laid directly onto, or above the insulation.

It is also important to insulate thermal bridges and limit ventilation, e.g. between the floor construction and walls.

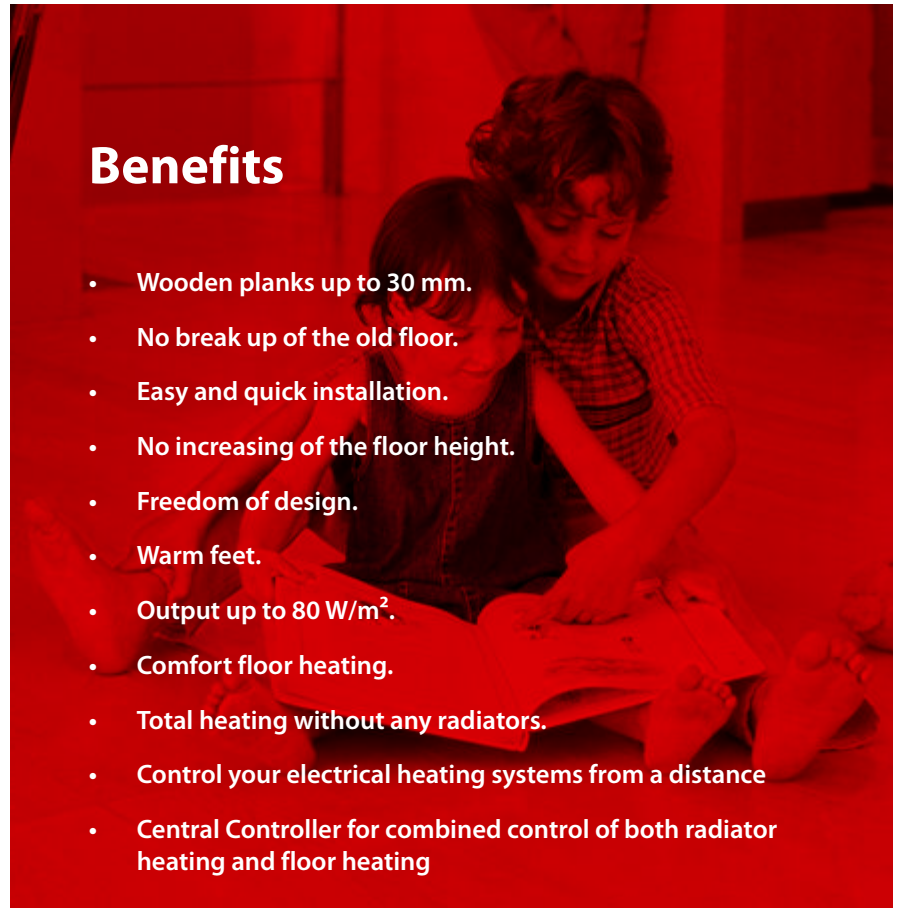

## Benefits

- **Wooden planks up to 30 mm.**
- **No break up of the old floor.**
- **Easy and quick installation.**
- **No increasing of the floor height.**
- **Freedom of design.**
- **Warm feet.**
- **Output up to 80 W/m<sup>2</sup>.**
- **Comfort floor heating.**
- **Total heating without any radiators.**
- **Control your electrical heating systems from a distance**
- **Central Controller for combined control of both radiator heating and floor heating**

#### Floor surfaces

Danfoss's floor heating systems may be used in connection with all known types of wood floorings, both in plank form and laminated. It is important that the wooden floors manufacturer's recommendations are carefully followed.

Wood shrinks and swells naturally depending on the relative humidity (RH) in the room. Wooden floors with a multi-layer construction and a surface layer of Beechwood or Maplewood shall not be installed over underfloor heating.

With regards to the thickness of the wooden floor, floor heating should only be installed if:

1. The maximum thickness of soft wood (density 400-600 kg/m<sup>3</sup> – pine etc.) is ≤ 2 cm.
2. The maximum thickness of hard wood (density over 600 kg/m<sup>3</sup> – oak etc.) is ≤ 3 cm.

#### Installation and floor construction

Floor construction has to be done according to the general and local building norms and standards.

The distance between the heating cable and the joists should be at least 3 cm.

The distance between the heating cables and the underside of the wood floor covering should be at least 3 cm.

The heating cables are installed on mesh netting (chicken wire), which is fastened to the sleepers (joists). The mesh netting is installed so there is a minimum distance of 3,5 cm between the netting and the underside of the floor surface.

The heating cable must be fastened to the mesh or foil at max. 30 cm intervals.

Heating cables may cross a joist through 3 x 6 cm recess, covered with metal (e.g. aluminum tape). Make sure the cable is never in contact with bare wood. There must never be more than one cable in each recess.

The bending diameter of the cables must not be less than 6 times the cable diameter. Minimum distance is: 5 cm between any two cable lines.

A floor sensor for the thermostat regulating the room temperature has to be installed inside the space below the wooden floor. Like shown on the adjacent picture.

The heating cable must be installed evenly in the spaces between the joists.

For additional information about installation, please refer to the Appendix A.4 and relevant heating cable/mats/elements installation instructions.

**Example.**

A 20 m<sup>2</sup> (4 x 5 m) well insulated kitchen has to be heated with direct electrical floor heating. The floor type is wooden floor on joists. The usable floor area is only 15 m<sup>2</sup>. The total heat loss has been calculated to 800 W (specific heat loss is 800/20 = 40 W/m<sup>2</sup>). Power supply is 230 V.

1. The calculated total required output for cable heating system should be 30% higher than heat loss (safety coefficient 1,3):  
 $800 \text{ W} \cdot 1,3 = 1040 \text{ W}$ .

2. Specific output, which is corresponding to 15 m<sup>2</sup> of usable floor:  
 $1040 \text{ W} / 15 \text{ m}^2 = 69 \text{ W/m}^2$ .

This is appropriate for floor heating underneath wooden floor on joists: max. 80 W/m<sup>2</sup>.

3. Choice of ECflex 10T cable with the nearest larger output: 1220 W, 120 m.

4. Total installed output per m<sup>2</sup> with chosen cable:  
 $1220 \text{ W} / 15 \text{ m}^2 = 81 \text{ W/m}^2$ .

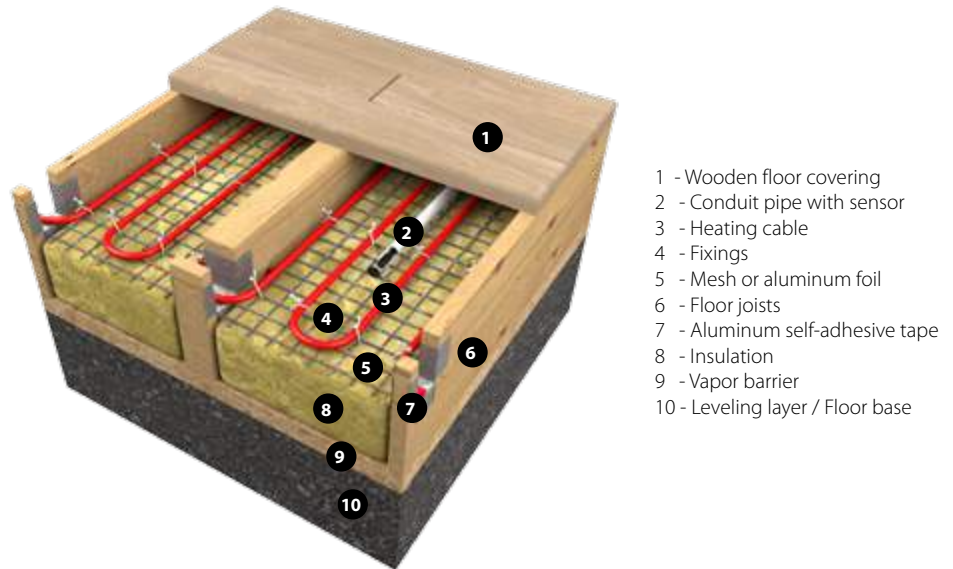

Fig. 13. Wooden floor on joists

This is appropriate choice for floor heating underneath wooden floor on joists: max. ~80 W/m<sup>2</sup> (higher only by 1 W/m<sup>2</sup>).

If is not appropriate, a cable with the nearest smaller output has to be chosen.

5. Calculation of C-C distance: as this cable covers up to 15 m<sup>2</sup>, the calculated C-C distance is (see Appendix A.1)  
 $15 \text{ m}^2 \times (100 \text{ cm/m}) / (120 \text{ m}) = 12,5 \text{ cm}$ .

6. Choice of thermostat, e.g. ECtemp Smart with Wi-Fi and APP control or ECtemp Touch.

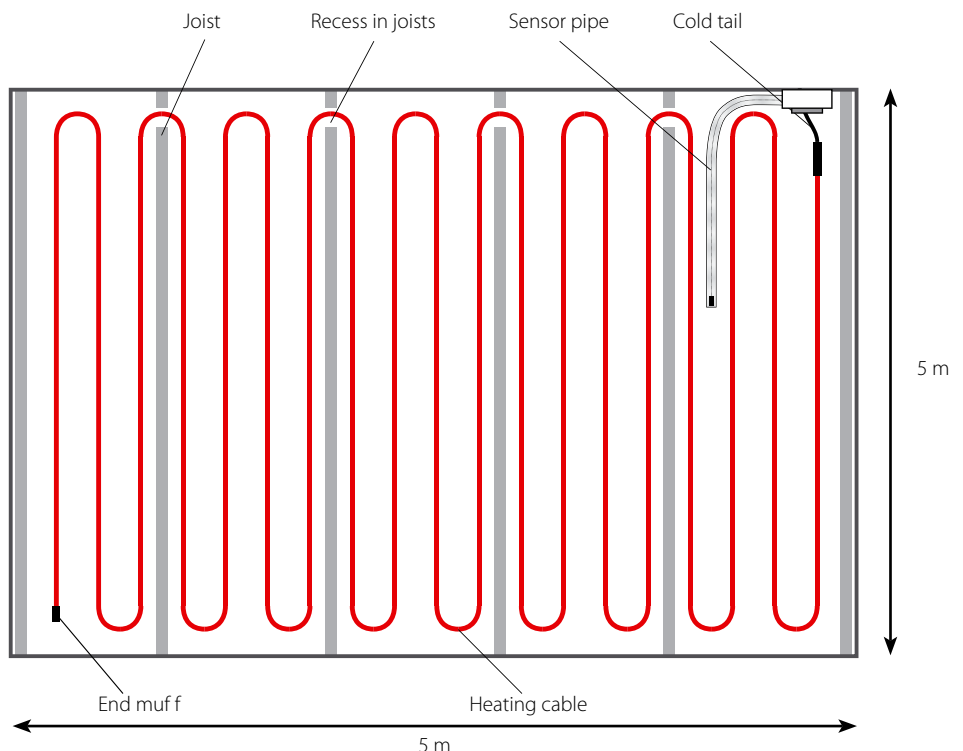

Fig. 14. Wooden floor on joists

## Installation steps - wooden floor on joists



1. Cable heating system: ECflex heating cable, thermostat with floor sensor and max temperature limit, fitting band, conduit pipe, aluminum tape.



2. Cut 3x6 cm recess in joists. Check C-C to do minimum number of recess (best on one side / end of joists).



3. Recess has to be covered with metal or aluminum tape etc.



4. Apply mesh or foil onto the insulation. Fasten it to the joists.



5. Install cable with chosen C-C distance. Max. 80 W/m<sup>2</sup> and cable output max. 10 W/m. Min. 3 cm distance to wood.



6. Fasten cable at max 30 cm intervals. E.g. plastic cable ties can be used. Secure that the heating cable does not rest in insulation.



7. Install the heating cable evenly over the whole floor area.



8. Install sensor pipe and wire sensor. Seal/close the end of pipe. Check resistance and insulation value of cable and sensor's resistance.



9. Install wooden surface. Check resistance and insulation value of cable and resistance of sensor and connect the thermostat.

### 5.3.3. ECdry – special heating element for dry installation under laminate etc.

When floors in flats, houses, basements or patios are renovated, comfort floor heating can be added without using screed or without breaking up the old floor. The comfort is provided by the ECdry system which is designed to be in contact with wooden sub or top floorings.

#### ECdry system

- consists of a 8 mm sandwich element providing an underlay with multiple properties;
- is installed on the old or sub floor, right under the new top floor;
- ensures fast responding floor heating and evenly distributed floor heat.

Using ECdry requires a mechanically stable and relatively even (ECdry equalizes floor unevenness up to 3 mm) understructure.

Parquet flooring of thickness below 8 mm, can be used with cable heating system, if its manufacturer allows it.

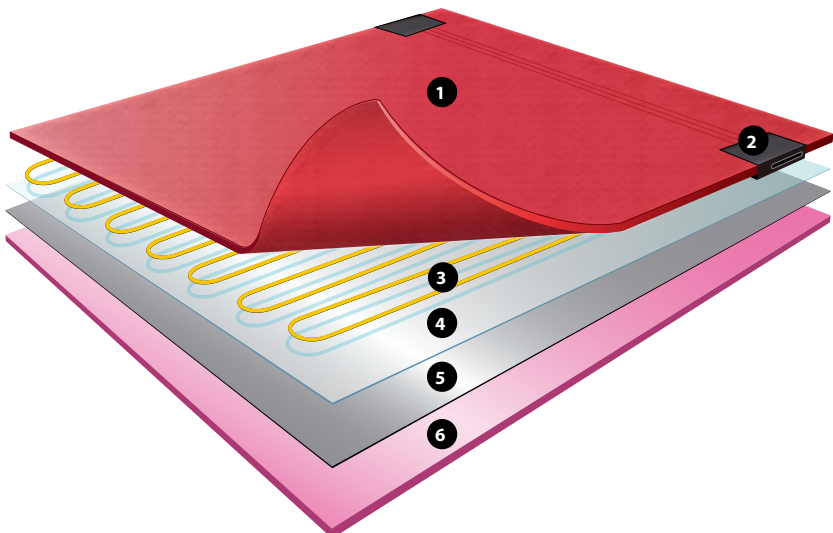

- 1 - Rubber layer – pressure distribution
- 2 - Connection – fast, sturdy and water proof IPX7
- 3 - Cables – providing 55 W/m<sup>2</sup> or 100 W/m<sup>2</sup> at 230 V
- 4 - Polyester Foil – reinforcing
- 5 - Aluminum Foil – heat distribution
- 6 - PP-Foam - sound reducing and insulating

Fig. 15. ECdry heating element construction



## Technical details ECdry heating element

Thickness: 8 mm.  
 Width: 1 m.  
 Length: 1, 2, 3, 4, 5 m.  
 Cutting areas: 25 + 25 cm.  
 Mains voltage: 230 V 50 Hz.  
 Max. Amperes per connector: 10A.  
 IP rating: IP X7.  
 Output: 55 W/m<sup>2</sup> and 100 W/m<sup>2</sup>.  
 Sound reduction value: 17 db.  
 Insulation value (U-value): 8 W/m<sup>2</sup>·K.

### Installed output and temperature limit

When heating is installed in wooden floors with ECdry few limitations should be observed.

#### Wooden subfloor:

- The installed output must not exceed 55 W/m<sup>2</sup>.
- The maximum temperature limit has to be 30°C.

#### Concrete subfloor:

- The installed output must not exceed 100 W/m<sup>2</sup>.
- The maximum temperature limit has to be 35 °C.

It should be noted that 55 W/m<sup>2</sup> can heat 1 m<sup>2</sup> of floor maximum up to approx. 5 °C in relation to air temperature (see also chapter: 4.1.1). For example if room air temperature is 18 °C: possible max floor temperature is approx. 23 °C. With such output, it is sometimes not enough to provide a feeling of warm floor or cover a requirement of the heat loss.

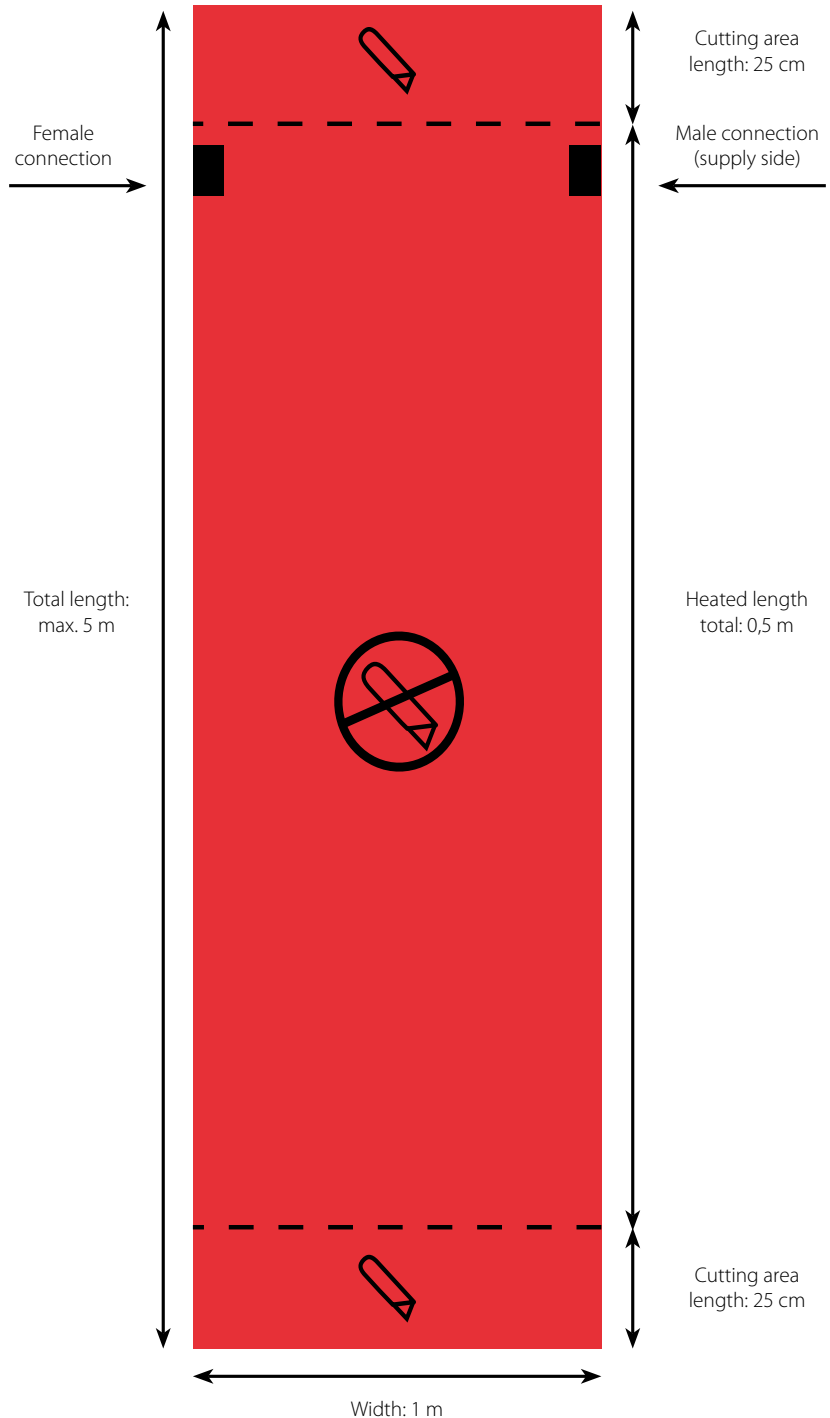

### Product choice

The ECdry system can be controlled in 2 ways, depending on the output, the floor construction and flooring material:



	Control kit	ECdry output	Subfloor		Flooring		
			Wood	Concrete	Wooden	Laminate	Carpet
 ECdry Touch Kit	55 W/m <sup>2</sup>	•	•	•	•	—	
	100 W/m <sup>2</sup>	—	•	•	•	—	

The ECdry system components can be selected from the following list:

Product	Options	Description
 ECdry	ECdry 55: 1, 2, 3, 4 and 5 m <sup>2</sup> . ECdry 100: 1, 2, 3, 4 and 5 m <sup>2</sup>	For wooden subfloors, max. 10 A per section. For concrete subfloors, max. 10 A per section
 ECdry Pro Kit	ECdry Touch Kit	With ECtemp Touch, limited to 35 °C, 16 A. 10A supply cord. Extra cord is required above 10 A
Accessories	ECdry Fillermat, 1, 2, and 4 m <sup>2</sup> . ECdry Extension cord.	Filler material. Extension cords for split elements; 25, 100, 200 cm.

### Thermal insulation

It is important that the floor construction is well insulated, according to general and local building regulations and standards. That way the heat loss downward is kept to a minimum. Otherwise heat loss down has to be evaluated and decision for correct additional output has to be made.

ECdry has an insulation resistance R of 0,125 m<sup>2</sup>·K/W and reduces the downward heat loss.

### Floor surfaces

ECdry system is designed to be in contact with parquet, laminate and carpet floorings.

It is important that the parquet floor manufacturer's recommendations are carefully followed.

The total insulation value R above cables is max. 0,18 m<sup>2</sup>·K/W (1.8 Tog). Or maximum thickness of soft wood (pine etc.) is 2 cm and maximum thickness of hard wood (oak etc.) is 3 cm.

Carpets up to 0,25 mm thick, with insulation value of: 0,125 m<sup>2</sup>·K/W are applicable but will reduce the floor temperature by 1-2 °C.

### Installation and floor construction

In order to avoid a fire hazard, the ECdry 100 is to be installed only above a floor of concrete or similar material.

ECdry 55 can be installed on either concrete or wooden floors.

Maximum set point temperatures of the thermostat are:

- 30 °C for wooden subfloors;
- 35 °C for concrete subfloors.

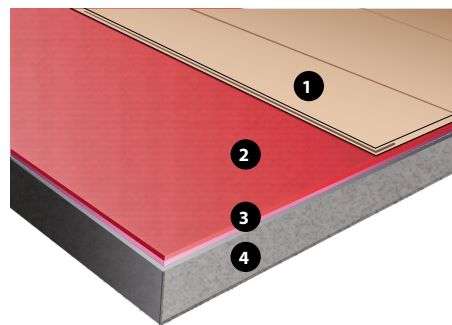

- 1 - Parquet/laminate/carpet
- 2 - ECdry 55 or ECdry 100
- 3 - Vapour barrier
- 4 - Existing concrete subfloor

Fig. 16. Floor heating with ECdry on existing concrete subfloor

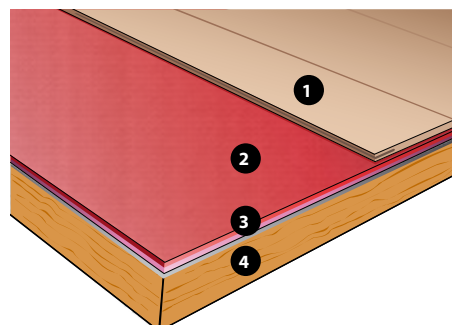

- 1 - Parquet/laminate/carpet
- 2 - ECdry 55
- 3 - Vapour barrier
- 4 - Existing wooden subfloor

Fig. 17. Floor heating with ECdry on existing wooden subfloor



Maximum heated surface by one system, composed by several sections (split heating elements), and is limited by max. current of 10 Amperes. For 2 types of ECdry outputs: 55 W/m<sup>2</sup> and 100 W/m<sup>2</sup> (at 230 V), the maximum heated areas for one system are: ECdry 55: ~42 m<sup>2</sup>; ECdry 100: 23 m<sup>2</sup>.

When connecting several ECdry elements, all must have the same area output (in W/m<sup>2</sup>).

The printed side of the heating element must be visible when rolling out the element showing the symbol: THIS SIDE UP.

We are recommending taping the heating elements/mats together, e.g. with aluminum tape or glued tape, especially under carpets.

Note that you can only attach power supply cord to one side of heated area – where male connector is placed. In other words, only 2 zones in the room are available for thermostat's installation (connection). First picture below shows connectors along top wall and place for thermostat installation (connection) is top-right corner of the room. Second picture shows connectors along bottom wall and place for thermostat installation is bottom-left corner of the room.

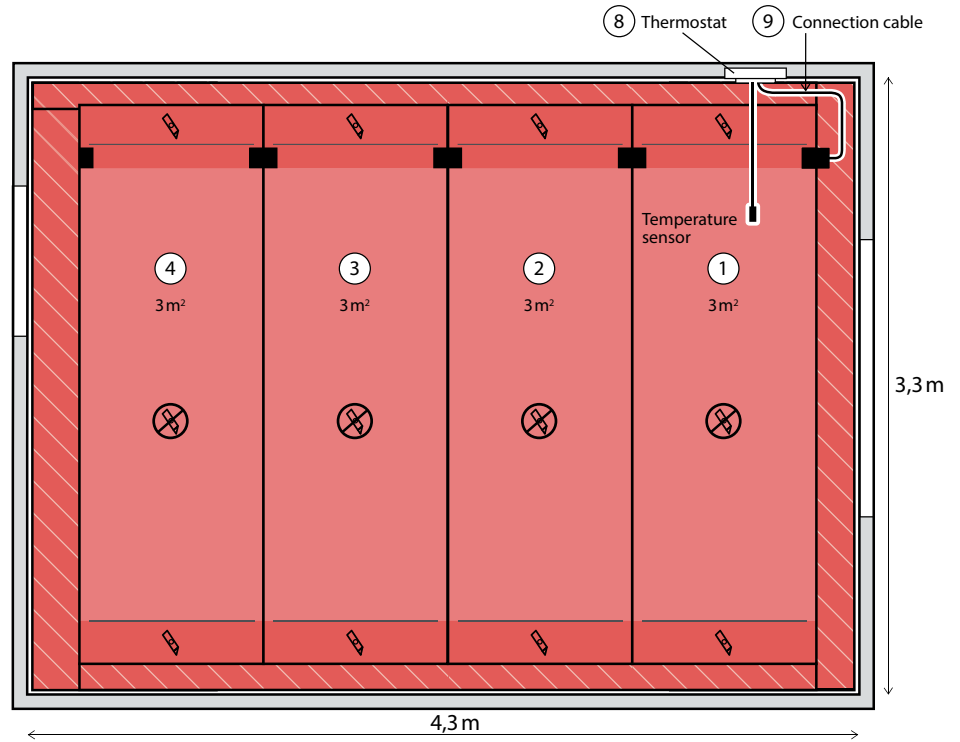

Fig. 18. Connectors along top wall and place for thermostat installation (connection to heating elements) at top-right corner of the room.

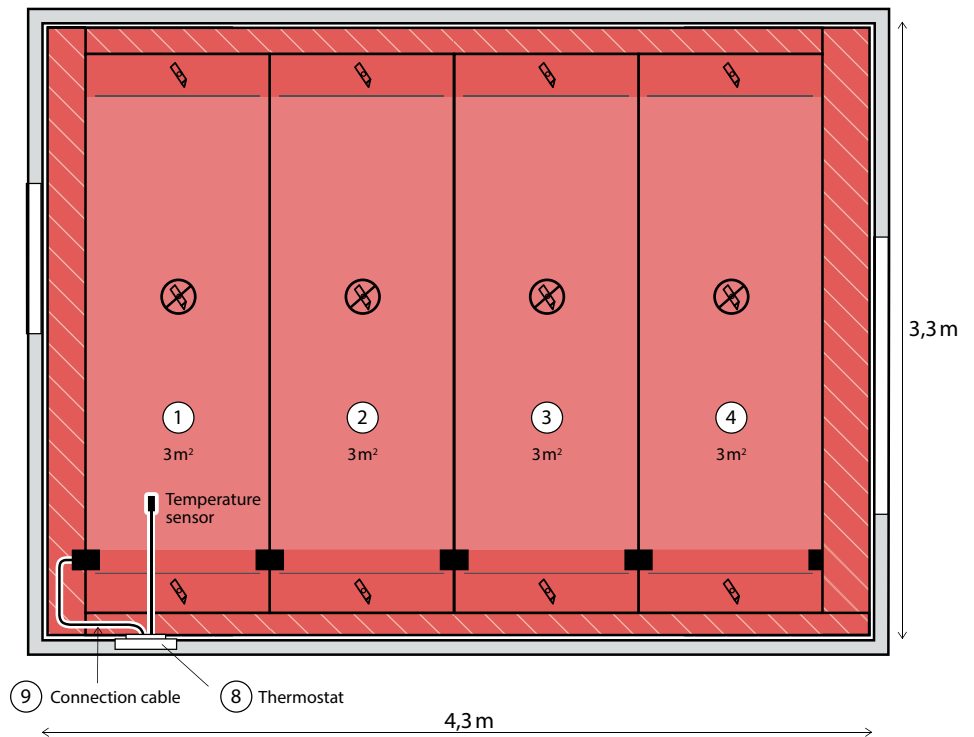
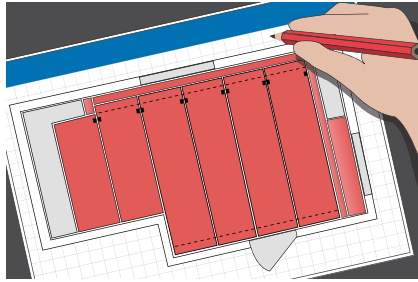

Fig. 19. Connectors along bottom wall and place for thermostat installation is bottom-left corner of the room.

## Installation steps – ECdry



1. ECdry heating system: ECdry Touch Kit, ECdry heating element, ECdry Fillermat filler material if any.



2. Recheck the layout, e.g. the placement of the control kit, floor sensors near the correct side of ECdry with male connector.

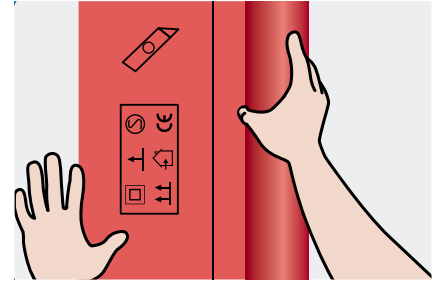

Make sure that the subfloor is reasonably level, firm and stable. Lay out a moisture barrier. Roll out the ECdry elements, the printed side of the elements must be visible.

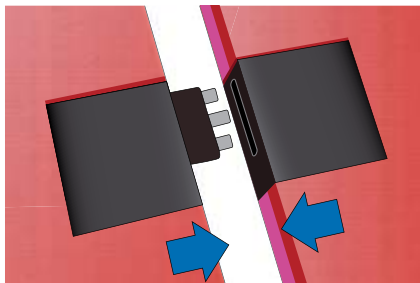

3. Remove the end stops from connectors. Put the male and female connector together by hand.

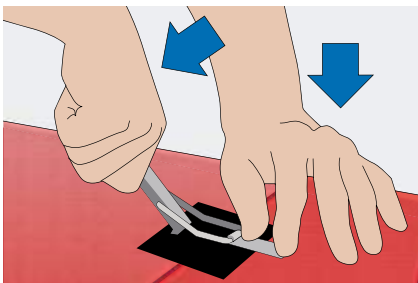

4. Push the elements/connectors tight together using the connector tool.

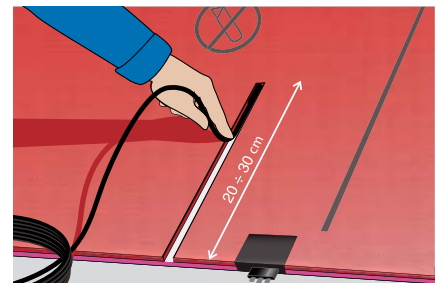

5. Rip off the pre-cut strip near supply cord connection and lay the sensor in the groove. Attach the included aluminum tape on top to fix the sensor cord.

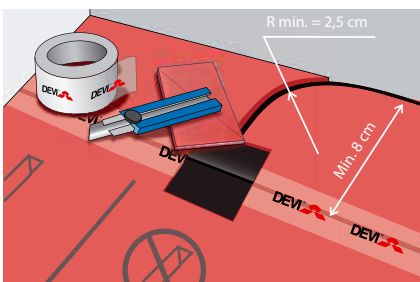

6. Cover the remaining part of the area with filler material. Cut out for supply and sensor cord and optionally extension cord.

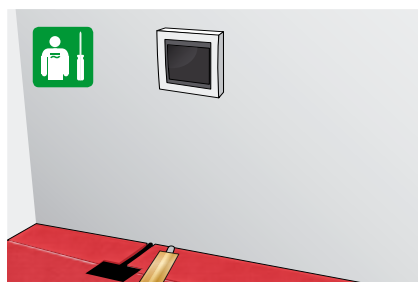

7. Check the insulation resistance of the heating elements. Install ECdry Touch Kit. Connect the cold tail, sensor and thermostat or plug the control into the socket.

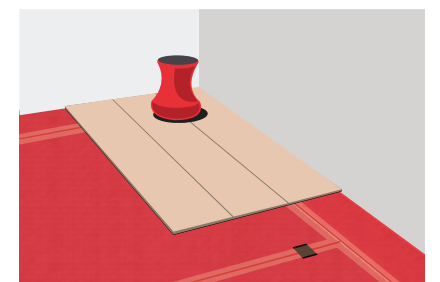

8. Make sure that the ECdry is heating before installing the floor finish. Tape the elements together. Install the floor finish directly onto the ECdry elements.

**Example 1.**

Living room of 3,03 x 4,88 m, 14,8 m<sup>2</sup>. Concrete subfloor, expected laminate flooring. Has to be heated with direct heating by ECdry system. The specific heat loss has been calculated to 80 W/m<sup>2</sup>. Power supply is 230 V.

1. The calculated required output for cable heating system should be including safety coefficient 1,3:  $80 \text{ W/m}^2 \cdot 1,3 = 104 \text{ W}$ .

This is correct to use Direct Floor Heating system with ECdry 100 heating elements with output 100 W/m<sup>2</sup> at 230 V.

2. One wall is 3,03 m – this corresponds to one of the ECdry 100 lengths – 3 m (240 W at 230 V). So it is good reason to install ECdry elements along this wall.

3. Second wall is 4,88 m. Width of ECdry heating mats is 1 m. So 4 mats can be installed.

4. Heated area by ECdry 100 with length 3 m:  $3 \cdot 4 = 12 \text{ m}^2$ .

Area without heating mats:  
 $14,8 \text{ m}^2 - 12 \text{ m}^2 = 2,8 \text{ m}^2$ .

Filler material has to be chosen:  
 ECdry Fillermat – 2 m<sup>2</sup>, 2 pcs.

5. Sum output of 4 pcs. ECdry 100:  $240 \cdot 4 = 960 \text{ W}$ . It is less than max 2300 W or 10 A.

6. Control kit: e.g. ECdry Touch Kit with timer thermostat ECtemp Touch.

ECdry solution:

- 1...4. ECdry 100, 3 m<sup>2</sup> – 4 pcs.
5. ECdry Fillermat, 2 m<sup>2</sup> – 2 pcs.
- 6, 7. ECdry Touch Kit with ECtemp Touch.

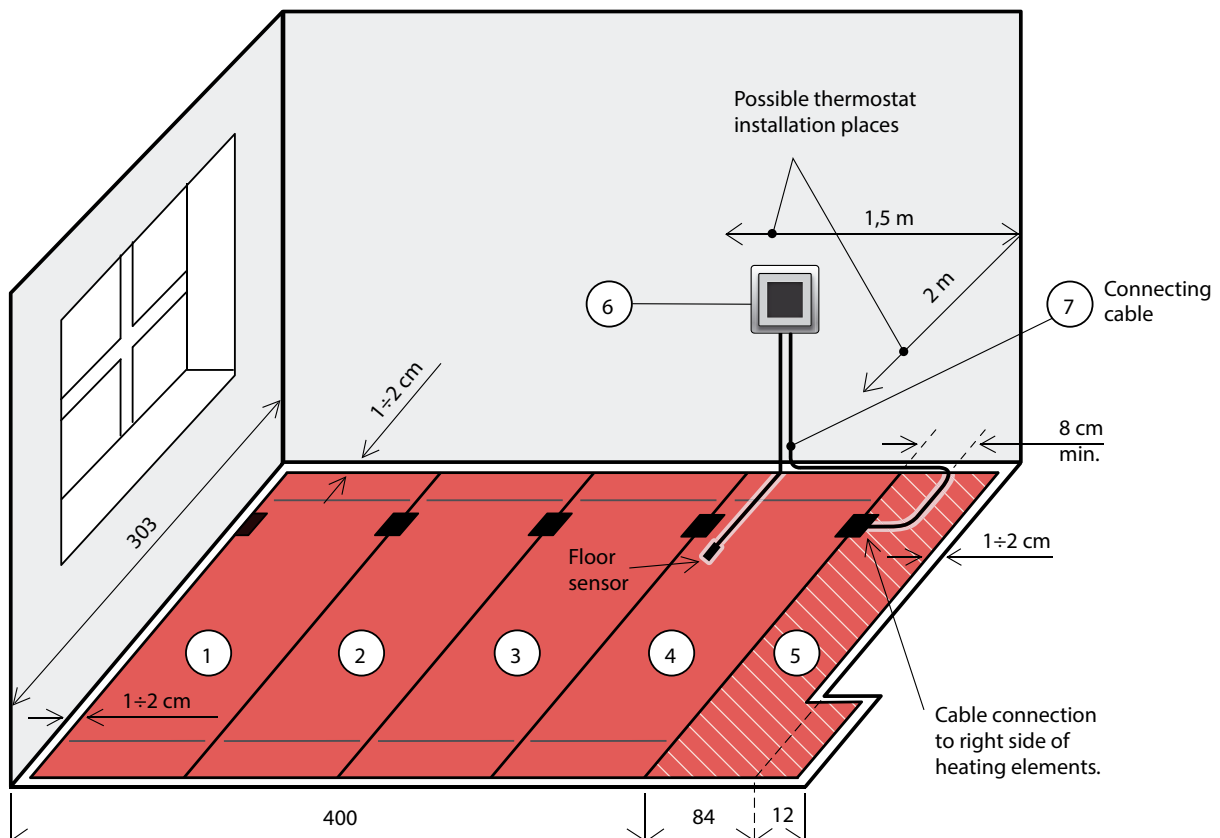

### Example 2.

Selection of ECdry heating mats for non-rectangular room. Max size is 3,3 x 6,5 m.

Mat installation along the long side of the room is impossible – mats with length 6,5 m long are not available. Therefore, mats should be installed along the short side of the room.

If the mat connectors are placed on the bottom side of the room (see the figure), there would be no possibility to connect mat to mat in one line because of the fracture walls. Consequently, connectors should be located along the top wall of the room.

The selected mat position specifies place where thermostat has to be installed: the upper-right corner is the only possibility. Near the right wall should be a strip, for example ~15 cm, for possibility to place connector of power supply cable.

Room area is:  
 $1,9 \times 2,2 + 4,3 \times 3,3 = 18,4 \text{ m}^2$ .

Four pcs. of ECdry heating mats,  $3 \text{ m}^2$  each, are installed on  $12 \text{ m}^2$ ,  
2 pcs. of  $2 \text{ m}^2$  are installed on  $4 \text{ m}^2$  –  
total heated area is  $16 \text{ m}^2$ .

Area of filler material is  
 $18,4 - 16 = 2,4 \text{ m}^2$ ,  
so chosen filler is: ECdry Fillermat  $2 \text{ m}^2$ ,  
2 pcs., total sum:  $4 \text{ m}^2$ .

DEVIdry™ solution:

1...4. DEVIdry™ 55/100,  $3 \text{ m}^2$  –  
4 pcs.

5, 6. DEVIdry™ 55/100,  $2 \text{ m}^2$  –  
2 pcs.

7. DEVIdry™ FM1,  $1 \text{ m}^2$  – 1 pc.,  
DEVIdry™ FM2,  $2 \text{ m}^2$  – 1 pc.

8, 9. ECdry Touch Kit.

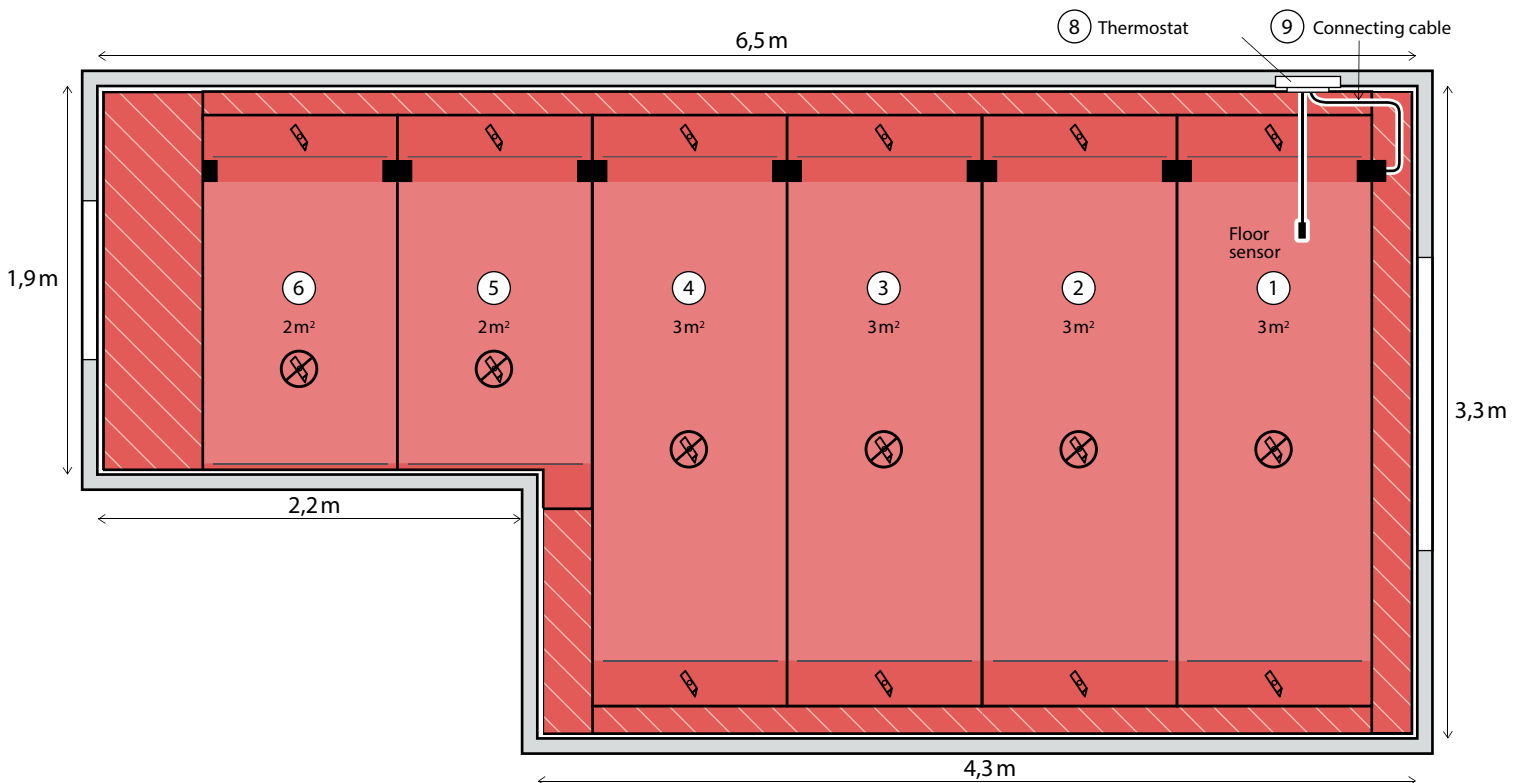

**Example 3.**

Selection of ECdry heating mats for area of complex form – room, corridor and hall.

Sum area 12,8 m<sup>2</sup>. Area heated by ECdry 10 m<sup>2</sup>. Thus needs 3 m<sup>2</sup> of filler material.

Extension cord ECdry Extension cord 0,25 m, 1 m or 2 m has to be used.

ECdry products:

- 1, 2. ECdry 55/100, 3 m<sup>2</sup>: 2 pcs.
- 3, 4, 5. ECdry 55/100, 1 m<sup>2</sup>: 3 pcs.
- 6. ECdry 55/100, 2 m<sup>2</sup>: 1 pc.
- 7. ECdry Fillermat, 2 m<sup>2</sup>: 2 pcs.
- 8. ECdry Extension cord 2 m: 1 pc.
- 9, 10. ECdry Touch Kit.

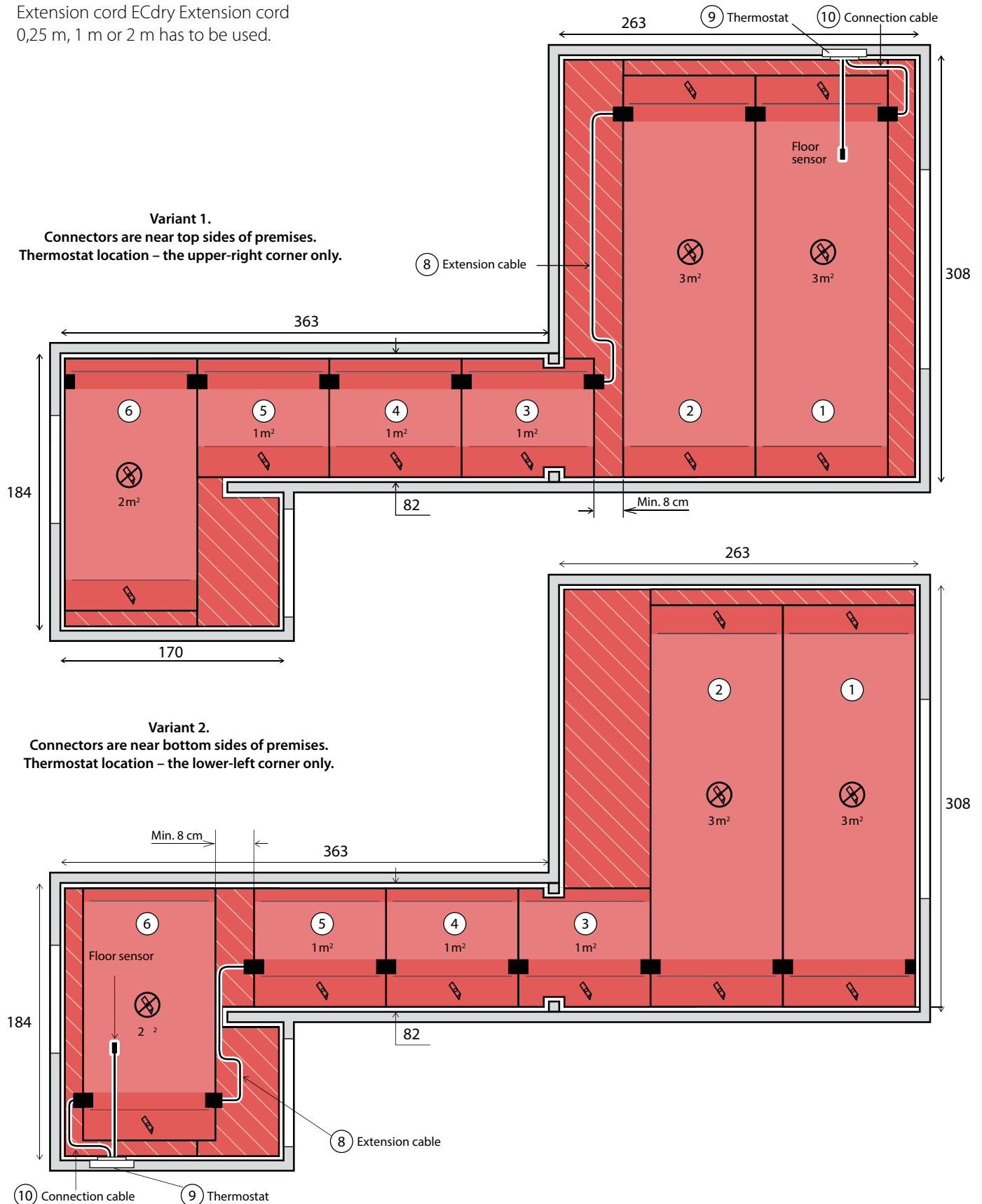

### 5.3.4. Reflect Insulated Plates (EFCI Dry) – heating system with heat distribution plates under laminate etc.

When floors in flats, houses, basements or patios are renovated, floor heating can be added without using screed or without breaking up the old floor. The comfort is provided by Reflect insulated plates heating system which is designed to be in contact with wooden sub or top floorings.

Reflect insulated plates (EFCI Dry):

- consists of a 12 mm polystyrene plate and a 1 mm aluminum plate with cable grooves;
- is installed on the old/sub floor, right under the new top flooring e.g. timber or parquet;
- ensures fast responding floor heating and evenly distributed floor heat;
- cable grooves every 10 cm;
- fits ECflex heating cable only.

Reflect insulated plates can be used for Comfort Floor Heating and for Direct Heating via Floor with output up to 100 W/m<sup>2</sup>.

See the installation manual for the product for further information.

#### Installed output

When heating is installed in wooden floors with Reflect insulated plates (EFCI Dry) few limitations should be observed:

1. The installed output must not exceed 100 W/m<sup>2</sup>.
2. The specific output of heating cables must not exceed 10 W/m.

#### Product choice

When cable heating system is installed in wooden floor with Reflect insulated plates (EFCI Dry) following Danfoss products can be recommended:

- Reflect insulated plates (EFCI Dry): 50x100 cm, 2 or 5 m<sup>2</sup> package;
- Mounting set for sensor: conduit pipe and end cup;
- Twin conductors heating cables ECflex 10T only.

Room thermostat with floor sensor, and with the maximum temperature limiting feature must always be used.



## Benefits

- **Dry installation.**
- **Thickness 13 mm only.**
- **No mason work with screed.**
- **Reduced downward heat loss.**
- **Even temperature distribution.**
- **Quick response time with timer.**
- **Up to 20 mm soft wood (pine).**
- **Up to 30 mm hard wood (oak).**
- **Linoleum/vinyl, thin carpets.**
- **Up to 100% floor coverage.**
- **Fits odd corners.**
- **Noise reduction 3 dB.**

More information about heating cables is found in chapter 2, or in Danfoss Product Catalogue and Installation Instructions.

#### Thermal insulation

It is important that the floor construction is well insulated, according to general and local building regulations and standards. That way the heat loss downward is kept to a minimum. Otherwise heat loss down has to be evaluated and decision for correct additional output has to be made.

Reflect insulated plates (EFCI Dry) have an insulation resistance R of 0,26 m<sup>2</sup>·K/W and reduces the downward heat loss.

#### Floor surfaces

Reflect insulated plates (EFCI Dry) floor heating system may be used in connection with all known types of wood floorings, both in plank and laminated form. It is important that floors manufacturer's recommendations are carefully followed.

Avoid Beech and Maple in multilayered constructions unless it's press dried.

Installation under carpets, linoleum or vinyl must be separated from cables by at least 5 mm of pressure distribution board. Observe the total insulation value above the pressure distribution board: R < 0,10 m<sup>2</sup>·K/W corresponding 1 Tog or a thin carpet.

With regards to the thickness of the wooden floor, Reflect insulated plates (EFCI Dry) floor heating should only be installed if:

1. The maximum thickness of soft wood (density 400-600 kg/m<sup>3</sup> – pine etc.) is ≤ 2 cm.
2. The maximum thickness of hard wood (density over 600 kg/ m<sup>3</sup>– oak etc.) is ≤ 3 cm.

For detailed information about whether a carpet can be used with floor heating, contact the carpet manufacturer.





**Fig. 20. Mounting method for heating cable into Reflect insulated plates (EFCI Dry)**

**Installation and floor construction**

Floor construction has to be done according to the general and local building norms and standards.

Reflect insulated plate (EFCI Dry) has cable grooves for every 10 cm and only one cable can be used: ECflex 10T. There are four possible heat densities

that can be installed with C-C 10 and 20 cm (at @230 V):  
ECflex 10T: 100 W/m<sup>2</sup> and 50 W/m<sup>2</sup>.

The bending diameter of the cables must not be less than 6 times the cable diameter. Min. 5 cm between any two cable lines.

For additional information about installation, please refer to the Appendix A.4 and relevant heating cable/mats/elements installation instructions.

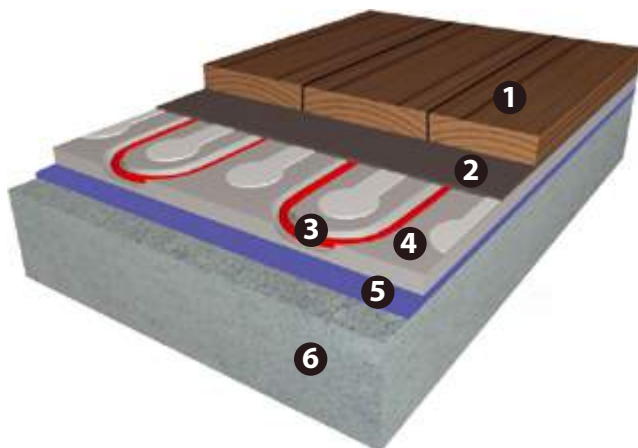

1. Timber, parquet or laminate.\*
2. Noise absorption mat / rag felt.
3. Heating cable ECflex.
4. Reflect insulated plates (EFCI Dry).
5. Vapor barrier or damp proof membrane.
6. Existing floor construction (e.g. concrete, gypsum, polystyrene)

\* The opposite combination with top flooring and existing floor construction is also optional.

**Fig. 21. Floor heating with Reflect insulated plates (EFCI Dry) on concrete floors**

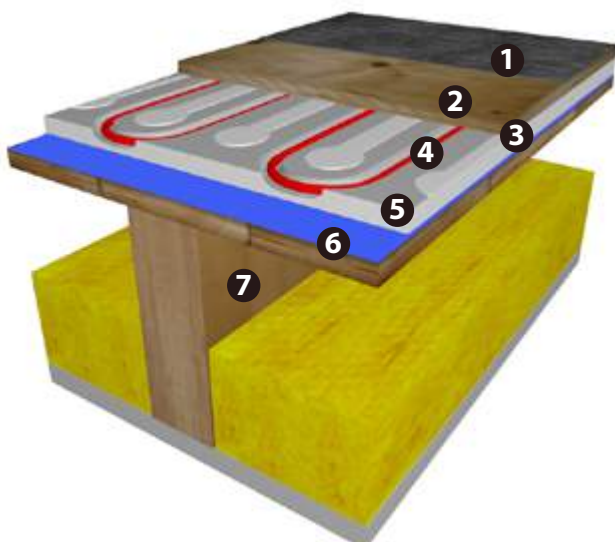

1. Linoleum/vinyl or carpet.\*
2. Pressure distribution board, min. 5 mm.
3. Noise absorption mat/rag felt.
4. Heating cable ECflex.
5. Reflect insulated plates (EFCI Dry).
6. Vapor barrier.
7. Existing wooden floor construction.

**Fig. 22. Floor heating with Reflect insulated plates (EFCI Dry) on existing wooden floors**

## Installation steps – Reflect insulated plates (EFCI Dry)

Required tools:

- Knife
- Compass saw
- File
- Glue gun
- Aluminum tape
- Milling cutter
- Installation manuals

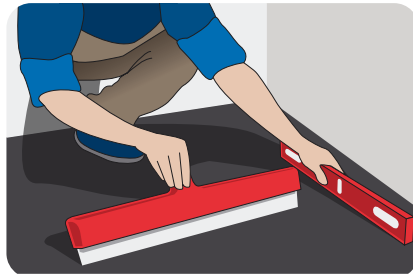

1. Make sure that the sub floor is reasonably level, firm and stable. New concrete needs to dry out for 30 days before installation.

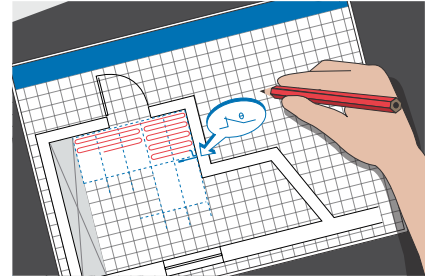

2. Draw a plan positioning cable, cold tail, floor sensor, thermostat and connection box, if any. Avoid all present and future objects fixed to the floor.



3. Cut out a wall groove and fix cable ducts and connection box. Clean the sub floor and lay out a vapor barrier or damp proof membrane (if required).



4. Install the Reflect insulated plates (EFCI Dry) on the heated areas and optionally 13 mm plasterboards on the non-heated areas. Connect the plates together with provided connection material.

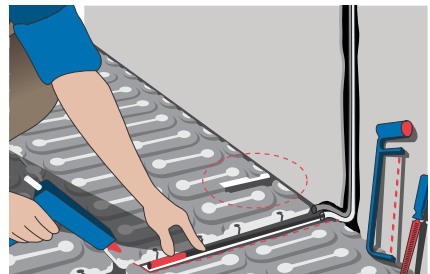

5. Cut out a hole for the warm/cold cable connection and the floor sensor conduit and file any sharp edges. Fix the conduit to the sub floor with glue or screws.

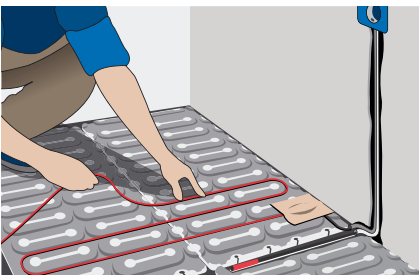

6. Check the insulation resistance and resistance (Ohm) rating of the heating cable before installation. Install the ECflex heating cable. Make sure that the cable end and connection muffs are in contact with the aluminum plate or aluminum tape at all times.



7. Check the insulation resistance and resistance (Ohm) rating of the heating cables. Plaster the wall groove and connect the cold tail, sensor and thermostat. Check resistance of sensor.

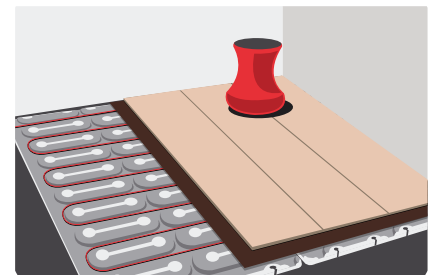

8. Install the floor finish at a room temperature of approximately 15 °C. Install a noise absorption mat and wooden floor, if desired.

**Example.**

A 28 m<sup>2</sup> living room has to be heated with direct electrical floor heating by Reflect insulated plates (EFCI Dry) heating system. The total heat loss has been calculated to 2240 W or specific heat loss is 2240 / 28 = 80 W/m<sup>2</sup>. Power supply is 230 V.

Heated floor area is 28 m<sup>2</sup>: 4 x 2 m<sup>2</sup> and 4 x 5 m<sup>2</sup> packages of Reflect insulated plates are chosen. Mounting set for sensor (plastic pipe / conduit) has to be used too.

Calculated cable heating system output with safety coefficient of 1,3 is 80 W/m<sup>2</sup> · 1,3 = 104 W/m<sup>2</sup>.

An installed heat density of 100 W/m<sup>2</sup> is chosen by means of ECflex 10T with 10 W/m (230 V) at Reflect insulated plates with fixed C-C = 10 cm.

The power required by cables is therefore 28 m<sup>2</sup> · 100 W/m<sup>2</sup> = 2800 W.

To avoid one excessive cable, 2 cables ECflex 10T of 1410 W (230 V) are chosen and sum output is 2820 W.

Another way for choosing a heating cable is the calculation of cable length.

Floor is 28 m<sup>2</sup> and C-C = 10 cm, hence the calculated cable length is 28 · 100/10 = 280 m. ECflex 10T with 140 m length and 2 pieces of this heating cable has to be chosen. Cable length is exactly equal to the installation area, e.g. cables will be installed close to its borders. This results in a danger, that the cables cannot be installed on this area, and need to cut off part of one cable could arise. However cutting the heating cable is strictly forbidden.

To avoid this, you should select the cables length nearest but lesser to calculated. So if it's necessary, due to lack of space, 2 cables of 120 m with sum length of 260 m, can be chosen as an alternative.

Thermostat for direct heating system and temperature limiting feature has to be selected: with a room/air sensor and floor sensor. A choice between two can be made: ECtemp Touch or ECtemp Smart with Wi-Fi control.

# Appendixes

## A.1. C-C distance and corresponding output W/m<sup>2</sup>

The C-C distance is the centre-to-centre distance between the cables (sometimes named installation step or Cable-to-Cable distance).

When heating cables are installed, we recommend the use of ECfast fitting bands. These bands are designed to ensure a C-C distance at regular intervals of 2,5 cm, e.g. 5 cm, 7,5 cm, 10 cm, 12,5 cm, etc.

Two different formulas may be used to calculate the C-C distance:

1) Using heating cable length

$$C - C [cm] = \frac{\text{Heated floor space [m}^2] \cdot 100 [cm/m]}{\text{Cable length [m]}} \cdot 100 \text{ cm.}$$

2) Using cable specific output and output per m<sup>2</sup>:

$$C - C [cm] = \frac{\text{Cable specific output [W/m]} \cdot 100 [cm/m]}{\text{Output per m}^2 \text{ heated floor space [W/m}^2]}$$

### Example 1

The ECflex 18T, 535 W, 29 m is to be installed in a bathroom with heated floor space of 3 m<sup>2</sup>.

The calculated by formula no. 1 C-C distance is:

$$C - C [cm] = \frac{3 \text{ m}^2 \cdot 100 \text{ cm/m}}{29 \text{ m}} \cdot 100 \text{ cm} = 10,35 \text{ cm.}$$

If we use ECfast fitting bands with

regular intervals of 2,5 cm, we can install the heating cable in this bathroom with a C-C distance of 10 cm.

### Example 2

For a floor renovation we choose a ECflex 10T cable (specific output is 10 W/m). If the chosen output is 120 W/m<sup>2</sup>, the calculated by formula no. 2 C-C distance is:

$$C - C [cm] = \frac{10 \text{ W/m} \cdot 100 \text{ cm/m}}{120 \text{ W/m}^2} = 8,33 \text{ cm.}$$

**C-C distances and corresponding outputs per m<sup>2</sup> for some linear outputs of heating cables.**

C-C distance, cm	Thermal output of heating surface for several Danfoss heating cables at 230* or 400* V, W/m <sup>2</sup>					
	6 W/m	10 W/m ECflex 10T	18 W/m ECflex 18T	20 W/m ECsnow 20T, ECflex 20T, ECbasic 20S	30 W/m ECsnow 30T	
5	120	200	360	400	600	Recommended for Ice and snow melting and Frost protection systems
7,5	80	133	240	270	400	
10	60	100	180	200	300	
12,5	48	80	144	160	240	
15	40	67	120	133	200	Recommended for Comfort floor or Direct heating systems
17,5	34	57	103	114	170	
20	30	50	90	100	150	
22,5	26	45	80	89	133	Surface heating, etc.
25	24	41	72	80	120	
Usually used for Direct floor heating						

\* The outputs at 220 or 380 V has to be recalculated with the coefficient of 0,91.

## A.2. Fitting

If we want to calculate the length of fitting band (e.g. ECfast, Montagestege™), we first have to determine the distance between the fitting bands.

For concrete floors, where the cable is covered with 3 cm of concrete or more, and the cable's C-C distance is more than 10 cm, the distance between fitting bands can be recommended 0,5-0,75 m.

For thin floors where the cable is covered with 1-2 cm of self-levelling compound and the cable's C-C distance is 10 cm or less, the max. distance between fitting bands is recommended to 25 cm.

Below is the formula for calculation of C-C distance.

$$\begin{aligned} \text{Length of fitting band [m]} &= \\ &= \frac{\text{Heated floor space [m}^2\text{]}}{\text{Distance between fitting bands [m]}} + L_w \text{ [m]}. \end{aligned}$$

$L_w$  is the length of the wall parallel to which the fitting bands are installed.

### Example

The heated floor space is  $1 \text{ m} \times 2 \text{ m} = 2 \text{ m}^2$ .

If we install ECfast fitting bands parallel to a 1 m wall and the distance between the ECfast fitting bands is 0,5 m, we need a fitting band with a length of:

$$\frac{2 \text{ m}^2}{0,5 \text{ m}} + 1 \text{ m} = 5 \text{ m}.$$

If we install ECfast fitting bands parallel to a 2 m wall and the distance between the ECfast fitting bands is 0,5 m, we need a fitting band with a length of:

$$\frac{2 \text{ m}^2}{0,5 \text{ m}} + 2 \text{ m} = 6 \text{ m}.$$

As we can see from this example, the length of fitting band may vary although the area and the distance between the fitting bands remain the same.

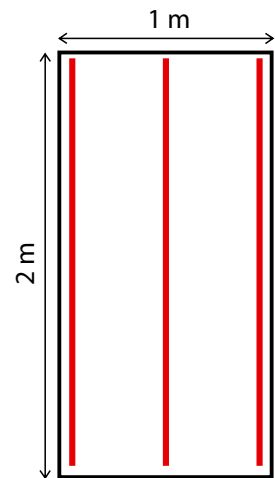
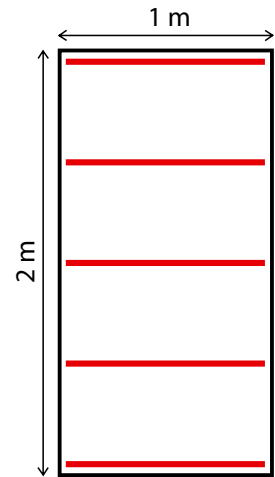

Fixing of the heating cable on the ECfast fitting band.

### A.3. Floor sensor installation

Before installation of the heating mat or cable, determine where to install the thermostat and make a recession in the wall for the mounting box. Cut out the wall groove from the thermostat's place down to the floor to install the connection cable (cold lead) of the heating cable and temperature sensor conduit. It is recommended, regardless of the system type, always to install floor sensor (wire sensor).

Floor sensor is usually mounted in the corrugated plastic pipe with a diameter of 10-20 mm. Pipe is laid in the wall groove starting from the mounting box and then along the flooring underlay to the heating area. It must be installed in the heating cable zone, at least 0,5-1 m inside (see included picture). Pipe should provide free replacement of wire sensor (remove-insert) through the hole in the mounting box.

Where the pipe is bent between the floor and the wall, the minimum bending radius is 6 cm. It is necessary to make a smooth bend of corrugated pipe when going from the wall to the floor. You can run one bend with large radius R1. As an option of a smooth bend, can be recommended making two big radius of tube in two planes R2 and R3 when going from the wall to the floor (where  $R2 > R1$ , and  $R2 \approx R3$ ).

The pipe has to be sealed at the end so the concrete does not enter it (marked A on pictures).

The pipe/sensor must be positioned in the centre at an open end of a cable loop and usually on the same level, or slightly above, the heating cables.

If thin heating mat is installed, conduit pipe has to be laid in a groove, so it does not to overhang above the surface. Groove in the floor is also required for the cold lead and muff for the same reason.

Sensor cable can be extended to any reasonable length, using a cable min 0,75 mm<sup>2</sup>.

After the wire temperature sensor is installed it is recommended to measure resistance.

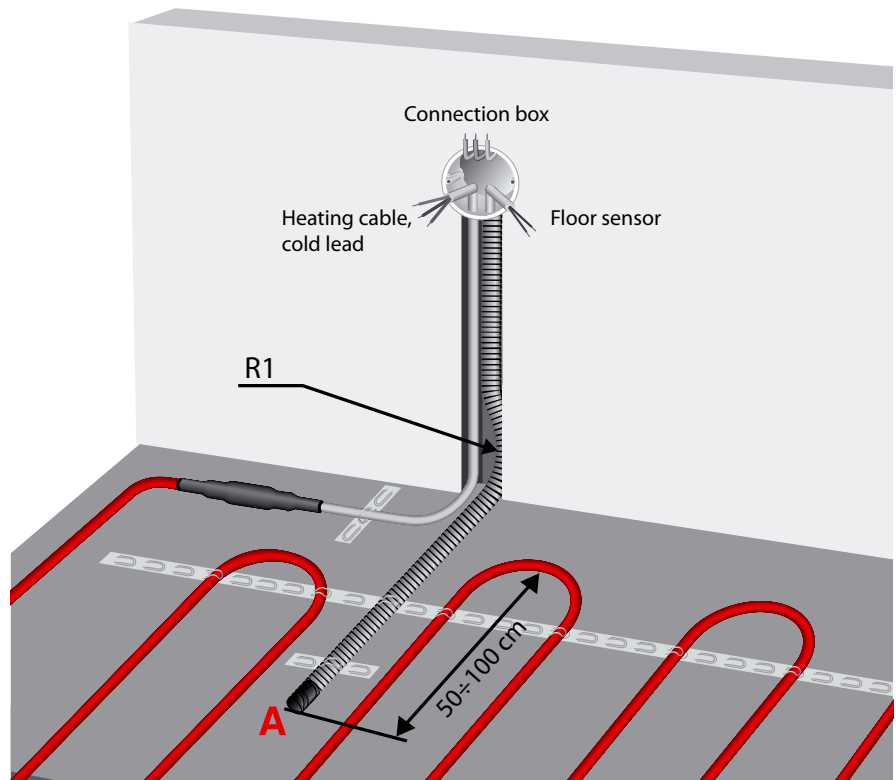

Sensor has to be installed between two heating cables and, preferably, slightly above their level.

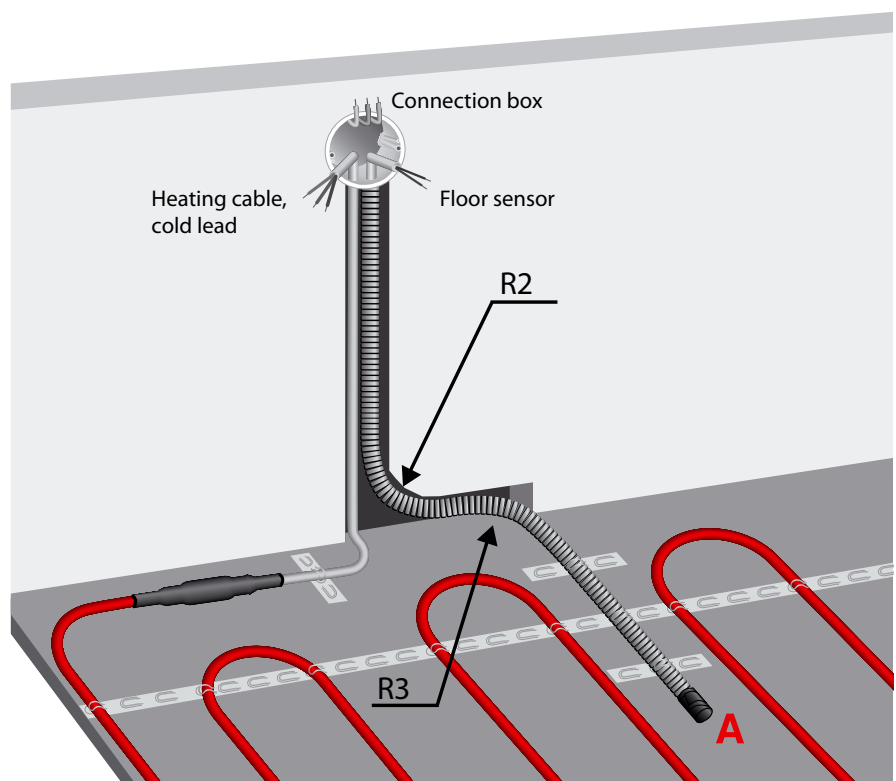



## A.4. General installation guide

The installation of heating cables and thermostats should comply with general and local regulations. The cables and the thermostats should only be connected by an authorized electrician and connected to an RCD.

It is important that the floor construction is well insulated according to the building standards so the downward heat loss is kept to a minimum.

Rim zone insulation, along the walls, which should be efficient in order to prevent heat from being transported to the foundation walls or adjoining rooms, and allowing for a thermal expansion of the concrete.

The foundation must be clean and free of sharp objects.

The cables must never get into contact with the insulation material or become enveloped by it in any way.

The cables must be evenly spread on the available floor and led around permanently fixed objects such as bathtubs etc.

The cables must be gently attached so they are not damaged.

The concrete around the cables must not contain sharp stones and should have a consistency enabling it to surround the cable completely without leaving air pockets. The concrete should be applied very carefully in order not to damage the heating cables!

Concrete must be laid out in such way, that air pockets inside it are avoided.

In connection with wet rooms (bathrooms etc.) a damp proof membrane should always be used in order to prevent moisture from entering the floor construction.

If the floor is built on the ground, a damp proof membrane is needed to prevent moisture from moving upwards and into the floor construction.

The wire of the floor sensor must be protected by a plastic pipe.

The sensor must be positioned in the centre at an open end of a cable loop. Where the pipe is bent between the floor and the wall, the minimum bending radius is 6 cm.

The pipe must be sealed at the end to prevent concrete from entering. Should the cable become damaged while being laid out or later during the building process, it is a great advantage in the fault finding process to know the exact positioning of the connection box between the heating cable and the cold cable as well the end of the cable end, as the cable layout. It is therefore important to make a sketch showing the positioning of these things in the room.

Heating cable and floor sensors resistance needs to be measured before, after installation and after installation of concrete, before thermostat is connected.

The heating cable and the connection muff between the heating cable and the cold cable must both be cast in concrete. If the cable is pushed down into the insulation material or covered by it in any other way, the surface temperature can become too high, which might result in cable defects at worst.

At low temperatures (below 5 °C) the cable can become difficult to handle due to the plastic sheath. This problem can be overcome by connecting the cables for a short period. For this purpose THE CABLE MUST BE ROLLED OUT! When the cable has become flexible again, the electrical flow should be disconnected. It is not recommended to lay cables at temperatures below - 5 °C.

The floor heating must not be turned on before the concrete has fully set. It takes approximately 30 days for concrete and usually 10-15 days for moulding compound, tile glue etc. (it is important carefully followed to manufacturer's recommendations).

Keep a min. 5 cm air gap beneath permanent objects like desks and beds, and floor surface with installed floor heating. In connection with wet rooms (bathrooms etc.) a damp proof membrane should always be used in order to prevent moisture from entering the floor construction.

Thermostat fitted with air (room) temperature sensor should always be placed on inner wall, away from doorway or other large openings, and not in direct sunlight.

Thermostat fitted with air (room) temperature sensor should be placed above the floor at ~1,5 m (0,8 - 1,8 m) height.

To ensure an accurate and easy installation of the cables, ECfast fitting bands can be used.

The ECfast fitting bands are equipped with attachment clips at intervals of 2,5 cm so the distance between the cable loops will be 5, 7,5, 10, 12,5, 15, etc.

## 6. Cases

### **TAS EVLER, Tas Evler, Antalya**

Situated within the idyllic countryside of Isla mlar, these charming new built stone villas are set amongst peaceful woodland and pine forest surroundings. Styled and designed to a high quality finish.

Project Size:

- 16 Villas – 4000 m<sup>2</sup>

Products:

- Heating cables:  
13750 m of ECflex 18T
- Thermostats:  
200 pcs. ECtemp Touch
- Accessories:  
210 pcs. ECfast



### **TURNING TORSO, Malmö, Sweden**

In the 54 storey tall Turning Torso Danfoss supplied the heating cables for the bathrooms in the otherwise water heated building.

The low build-up height of heating systems creates an advantage.

Project size:

- 180 bathrooms

Products:

- Type of cable: ECflex 10T

For more case stories for electric indoor heating visit [www.heating.danfoss.com](http://www.heating.danfoss.com).



**Danfoss A/S** · Heating Segment · Ulvehavevej 61 · 7100 Vejle · Denmark  
Tel.: +45 7488 8500 · Email: [heating@danfoss.com](mailto:heating@danfoss.com) · [www.heating.danfoss.com](http://www.heating.danfoss.com)

Danfoss can accept no responsibility for possible errors in catalogues, brochures and other printed material. Danfoss reserves the right to alter its products without notice. This also applies to products already on order provided that such alterations can be made without sub sequential changes being necessary in specifications already agreed. All trademarks in this material are property of the respective companies. Danfoss and the Danfoss logotype are trademarks of Danfoss A/S. All rights reserved.