

Application Guide

Heating Control

Danfoss Link[™] & Connect Thermostats



Table of Contents

1. Introduction

1.1	Segment	3
1.2	<i>Danfoss Eco</i> ® programmable radiator thermostat	3
1.3	Overview of units in a <i>Danfoss Link™</i> system.....	3
1.4	Number of units in a <i>Danfoss Link™</i> system	4
1.5	Best Practice	4

2. General Guidelines

2.1	Heat supply	6
2.2	Functions	7
2.3	Rooms	8

3. Applications

3.1	Heating system with Boiler	11
3.2	Heating system with Central Boiler.....	13
3.3	District Heating.....	14
3.4	Heat Pump	15

1. Introduction

1.1 Segment

This application guide covers the use of *Danfoss Link™*, *Danfoss Link™* Connect Thermostat wireless heating controls and *Danfoss Eco™* in 1 and 2 family houses and flats up to 300 m².

1.2 *Danfoss Eco™* programmable radiator thermostat

Danfoss Eco™ is a stand-alone intelligent and programmable radiator thermostat* for residential use, where a central control system is not available. It is easy to install and is supplied with adapters for all thermostatic valves manufactured by Danfoss and most other radiator valve manufacturers.



1.3 Overview of units in a *Danfoss Link™* system

The following units can be used in a *Danfoss Link™* wireless system:

***Danfoss Link™* CC Central Controller** is the unit, from which the entire installation can be controlled. One *Danfoss Link™* CC is always needed in a system.



***Danfoss Link™* Connect Thermostat** is an electronic radiator thermostat* for residential use, which is controlled by a *Danfoss Link™* CC.

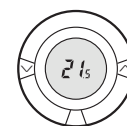

***Danfoss Link™* HC Hydronic Controller** allows control of hydronic floor heating with a large range of functions.



***Danfoss Link™* RS Room Sensor** is used for measuring and adjusting the room temperature.

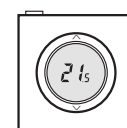

***Danfoss Link™* FT Floor Thermostat** is used for measuring and adjusting electrical floor heating.

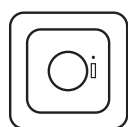

***Danfoss Link™* BR Boiler Relay** is a unit for turning gas and oil boilers ON/OFF, depending on heating demand.

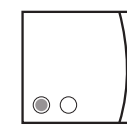

***Danfoss Link™* RU Repeater Unit** is used for extending the wireless transmission range between *Danfoss Link™* CC and other units in a system.

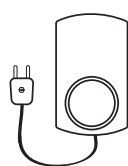

* *Danfoss* recommends using *Connect* and *Eco™* Thermostats together with *Danfoss* radiator valves with integrated pre-setting in order to achieve optimal performance.
For choice of adaptor please use the *Danfoss* adaptor guide, which also includes adaptors for non *Danfoss* valves.

1.4 Number of units in a *Danfoss Link™* system

When building a wireless *Danfoss Link™* control system it is important to follow these rules:

1. The **total** number of units must not exceed 50 (1 *Danfoss Link™* Central Controller + 49 units).
2. The number of **each type** of unit must not exceed:

<i>Danfoss Link™</i> CC.....	1 unit
Connect Thermostat.....	30 units
<i>Danfoss Link™</i> HC.....	3 units
<i>Danfoss Link™</i> RS.....	30 units
<i>Danfoss Link™</i> FT.....	30 units
<i>Danfoss Link™</i> BR.....	1 unit
<i>Danfoss Link™</i> RU.....	3 units

1.5 Best practice

Mains powered units

Avoid disconnecting mains powered units in a *Danfoss Link™* system. In the event this happens the system will eventually re-establish the network, when repeater unit is reconnected to the mains power.

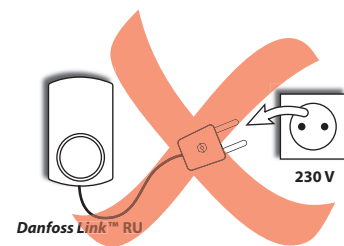

Danfoss Link™ RU Repeater units

It is always recommended to use *Danfoss Link™* RU, when a repeater is needed to extend the radio communication range. Several mains powered units (such as relays) also act as repeaters, but with limited capability to improve the communication range compared to *Danfoss Link™* RU. *Danfoss Link™* RU repeaters should always be registered as the first 230 V units in the system.

Danfoss Link™ RS Room Sensor

The *Danfoss Link™* RS is designed to measure the room temperature and control the Connect Thermostats to reach the set room temperature. The *Danfoss Link™* RS is useful in all applications where the actual temperature at the Connect Thermostat is significantly different from the desired room temperature., or if you have multiple radiators in the same room.

Best performance of the system with Connect Thermostats and *Danfoss Link™* RS is achieved, if the RS is not too far from the radiator, best between 1 and 5 meters.

Make sure to select the proper settings for the Connect Thermostat and *Danfoss Link™* RS on *Danfoss Link™* CC. Choose the "covered radiator" option if the radiator is behind a fixed radiator cover and possibly if the radiator and Connect Thermostat is covered by heavy furniture.

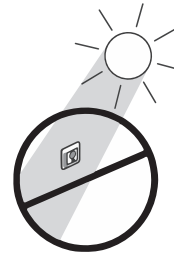

Do not install Danfoss Link™ RS on outer walls or where it will be subject to direct sunlight.

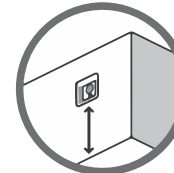

The installation height should typically be between 80-150 cm.



In wet rooms Danfoss Link™ RS shall be installed according to local building regulations.



At least 50 cm away from windows/doors that will be left open occasionally.

2. General Guidelines

2.1 Heat supply

If the heating system has been optimized for constant set temperature around the clock, you may need to adjust the settings when working with setback periods. When changing the temperature from a low economy setting to a comfort temperature, the system must be able to supply enough heat to raise the room temperature at least 1 °C per hour to perform well. Compared to a steady temperature the heating system must typically be able to supply 25% more heat, but only for a short period of time during heat up.

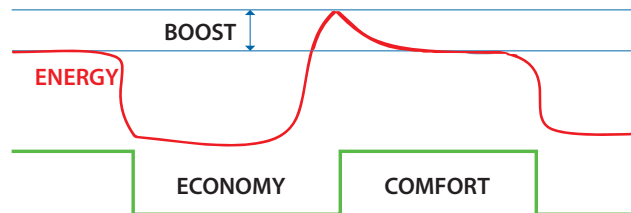

How to achieve 25% extra capacity in a system that should run boost:

Limitations	Action
Max. ΔP and temperature reached:	Increase valve presetting
Max. temperature and preset reached:	Increase pump pressure
Max. preset and ΔP reached:	Increase water temperature

Note: Maximum acceptable presetting, water temperature and pump differential pressure settings are different from system to system and depend on the application.

For radiator valves with pre-setting, balance the system to allow for enough flow.

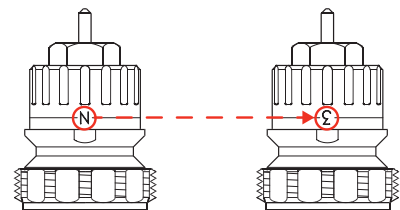

The supply line temperature at the radiator valves should be above 40 °C to ensure optimal control.

Make sure that the supply water temperature and flow is adequate to provide enough energy.

Increase the temperature or the pump level, if necessary.

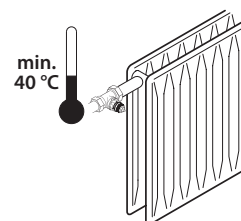

2.2 Functions

Connect Thermostats have a built-in function, which automatically shut off the heat while the room is ventilated. When the thermostat detects a drop in room temperature, it closes the valve.

To prevent excessive cooling of the room, the thermostat will automatically open the valve again after 30 minutes, meaning that during longer periods of ventilation you must manually set the temperature down.

To prevent multiple detections of ventilation, e.g. caused by opening a door, leading to instability, the thermostat will not detect a new ventilation session in a period of 45 minutes from the previous occurrence.

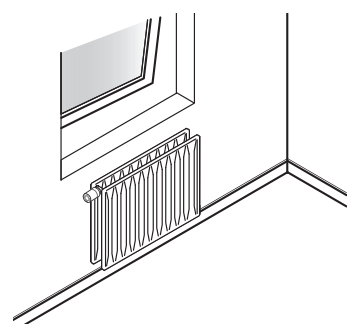

Be aware that a large window sill might prevent the Connect Thermostat from detecting cold air from an open window, and thereby not activate the automatic Open-window function.

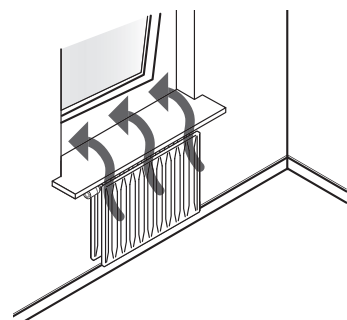

If the radiator is under or oversized in relation to the room, the settings should be changed accordingly.

Connect Thermostat: to change the settings, please refer to the Connect Thermostat installation and user guide.

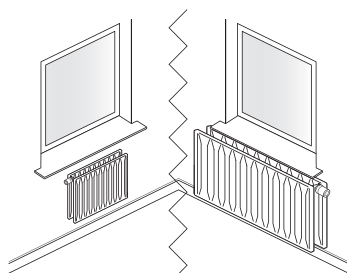

The adaptive learning function (Forecast) ensures that the comfort temperature is reached at set time. The warm up time is continuously adjusted according to seasonal temperature changes.

- Adaptive learning ensures the wanted temperature at the wanted time (here 20 °C at 07:00).
- Adaptive learning uses data from the previous 7 days to be able to reach the correct temperature at the right time.
- Adaptive learning is sensitive to large, rapid temperature changes.

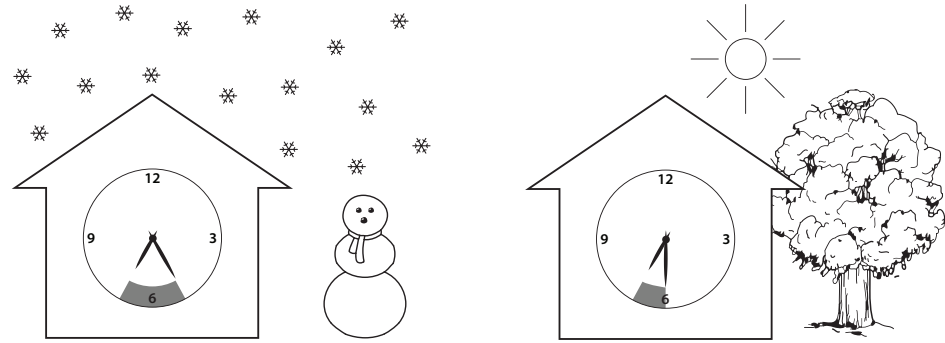

Winter: Long warm up time.

Spring/fall: Short warm up time.

2.3 Rooms

Covering the radiator - e.g. with furniture, curtains or a radiator cover - might cause heat to be accumulated around the thermostat.

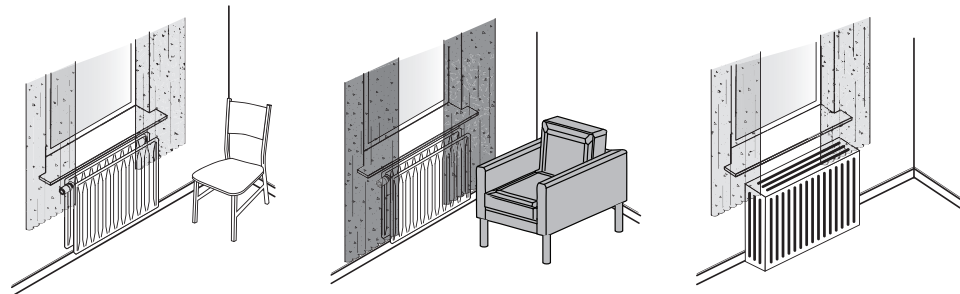

Light curtain/furniture:

- *Connect* Thermostat: can be used, but function is improved by using a RS room sensor.
- *Danfoss Eco™*: can be used, but it might be necessary to raise the set temperature.

Medium curtain/furniture:

- *Connect* Thermostat: use with *Danfoss Link™* RS room sensor.
- *Danfoss Eco™*: can be used, but it might be necessary to raise the set temperature.

Radiator cover:

- *Connect* Thermostat: use with *Danfoss Link™* RS room sensor.
- *Danfoss Eco™*: not recommended in this situation.

If two radiators are placed within 40 cm of each other, the heat emission from one radiator can affect the thermostat on the other radiator.

- *Connect* Thermostat: use with *Danfoss Link™* RS room sensor.
- *Danfoss Eco™*: balance the two radiators by adjusting the set temperature on the affected radiator.

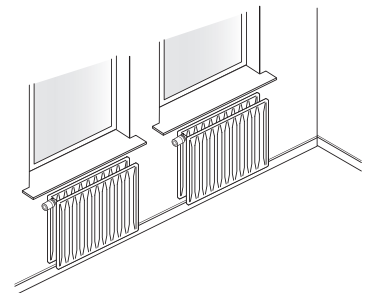

Direct heat radiation from large radiators may disturb the Connect Thermostats ability to measure the room temperature correctly.

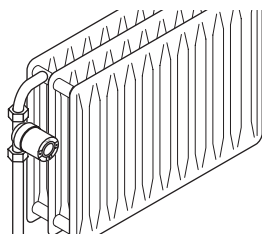

To avoid this, mount the thermostat pointing away from the radiator. The optimal solution is a Connect Thermostat with a *Danfoss Link™* RS room sensor.

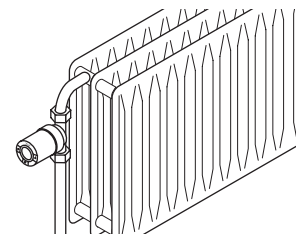

Danfoss do not recommend to use an angle adapter, instead the valve should be turned or replaced.

A fireplace in the room can affect the adaptive learning function of the Connect Thermostat and disturb the heating control.

If you use your fireplace regularly it is recommended to deactivate the adaptive learning.

By deactivating the adaptive learning function, Connect will work as a traditional thermostat, but with a delay in heating up the room after the fire has burned out.

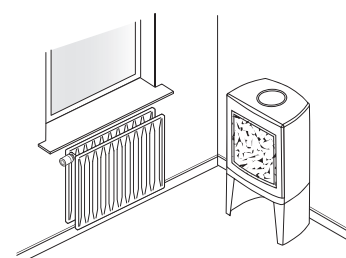

Note: If the valve has been closed for a longer period there may be a delay in heating up the room.

Sunlight from large windows in the room can affect the adaptive learning function of the Connect Thermostat and disturb the heating control. Then it is recommended to deactivate the adaptive learning.

By deactivating the adaptive learning function, Connect will work as a traditional thermostat, but with a delay in heating up the room after the heating from the sunlight has stopped.

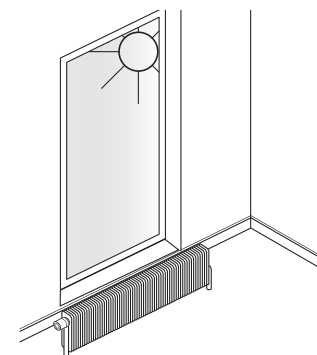

Continuous draft from a leaky window or garden door directly on the Connect Thermostat will disturb the heating control.

- Connect Thermostat: use with *Danfoss Link™* RS room sensor.
- *Danfoss Eco™*: We do not recommend using *Danfoss Eco™* in installations where temperature measurement at the thermostat is not representative of the room temperature. In an installation with frequent draft, the regulation may become instable and lead to fluctuating temperature and reduced battery life.

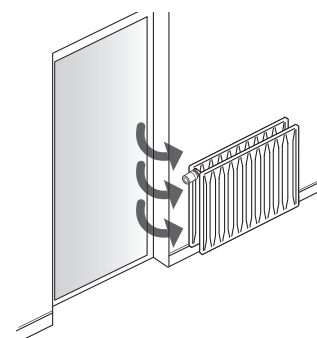

Connect Thermostats are primarily designed to be used with supply valves.
But Connect Thermostats can also be used with return valves on small radiators (smaller than 120 cm diagonally, rule of thumb).
On larger radiators with return valves Connect Thermostats are not recommended.

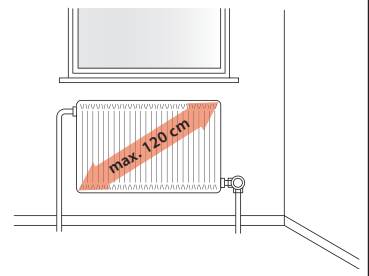

Neither Connect Thermostat nor *Danfoss Eco™* should be used on convectors placed in floor trenches.

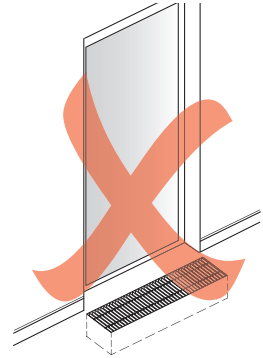

3. Applications

3.1 Heating System with Boiler

Description

A boiler with build-in or external domestic hot water tank can provide instant heat for the heating system, as well as for the domestic hot water.

The system can be operated with or without a *Danfoss Link™* BR (Boiler Relay).

Minimum requirements

- ▶ minimum 40 °C supply temperature at the valve.
- ▶ sufficient heating capacity to increase the room temperature with 1 °C per hour.
- ▶ only radiator valves approved for Danfoss adapters.

Note! Bypass valve is recommended.

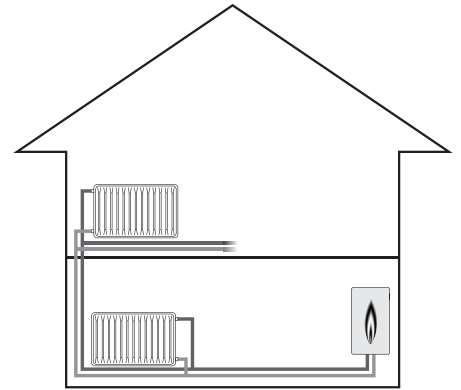

Recommendations

Central room temperature with night setback

If a central room temperature controller is used in combination with Connect Thermostats, it must only be as temperature limiter.

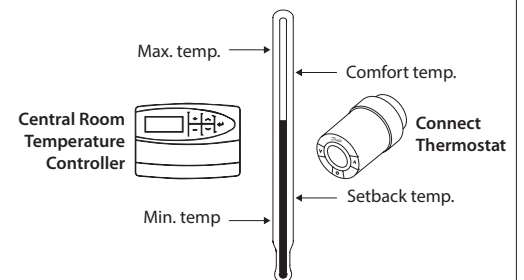

Boiler turned off at night

If the boiler is turned off or has reduced temperature during the night, then make sure that it is active when the Connect Thermostat is programmed to warm. In a system with *Danfoss Link™* CC and Connect Thermostat, this can be controlled automatically by adding a boiler relay

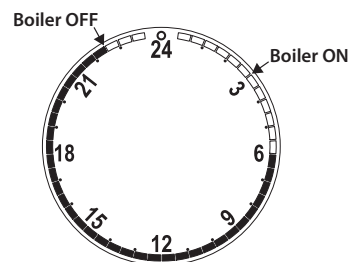

With Forecast: The Forecast period should vary over the year, but typically the boiler will start up to 3 hours before the comfort period.

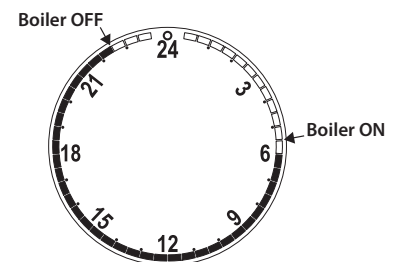

Without Forecast: The boiler should typically start up ½ hour before the comfort period.

Weather compensation

If the boiler's heating curve is set to have the radiator thermostats on comfort temperature constantly, the curve must be increased in order to be able to raise the room temperature after a setback period.

- If the setback periods are long, further increase might be necessary.
- If the economy periods are short, less increase can be sufficient.

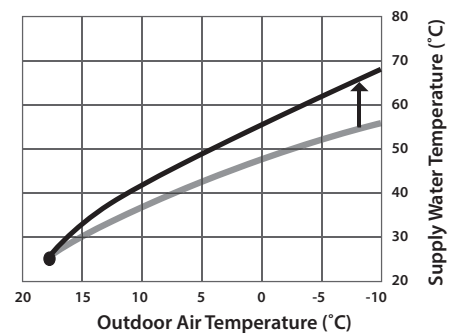
**Boiler relay**

Set *Danfoss Link™* BR boiler relay to automatic ON/OFF in the *Danfoss Link™* set-up menu.

3.2 Heating System with Central Boiler

Description

A large gas, oil or pellet boiler which provides hot water to several households.

Min. requirements

- ▶ min. 40 °C supply temperature at the valve.
- ▶ sufficient heating capacity to increase the room temperature with 1 °C per hour.
- ▶ only radiator valves approved for Danfoss adapters.

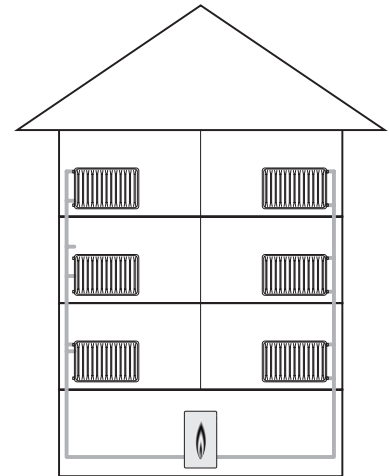

Recommendations

Boiler turned off at night

If the boiler is turned off or has reduced temperature during the night, then make sure that it is active when the Connect Thermostat is programmed to warm. In a system with *Danfoss Link™* CC and Connect Thermostat, this can be controlled automatically by adding a boiler relay

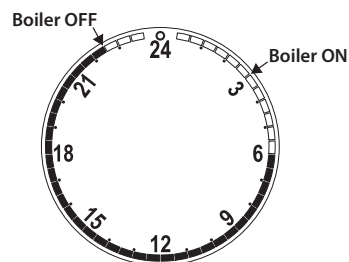

With Forecast: The Forecast period should vary over the year, but typically the boiler will start up to 3 hours before the comfort period.

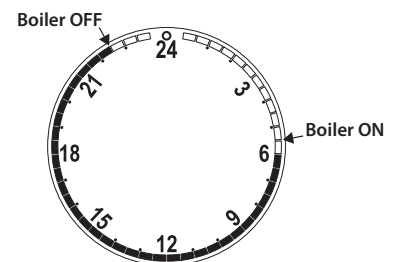

Without Forecast: The boiler should typically start up ½ hour before the comfort period.

Weather compensation

If the boiler's heating curve is set to have the radiator thermostats on comfort temperature constantly, the curve must be increased in order to be able to raise the room temperature after a setback period.

- If the setback periods are long, further increase might be necessary.
- If the economy periods are short, less increase can be sufficient.

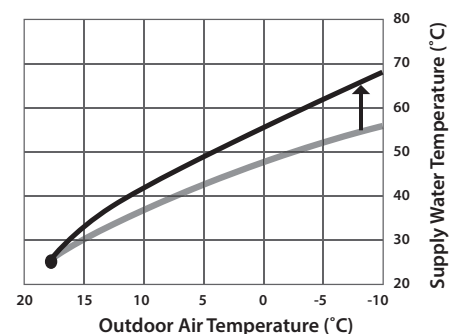

3.3 District Heating

Description

District heating is generated in a centralized location and distributed to residential and commercial use.

Min. requirements

- ▶ min. 40 °C supply temperature at the valve.
- ▶ sufficient heating capacity to increase the room temperature with 1 °C per hour.
- ▶ only radiator valves approved for Danfoss adapters.

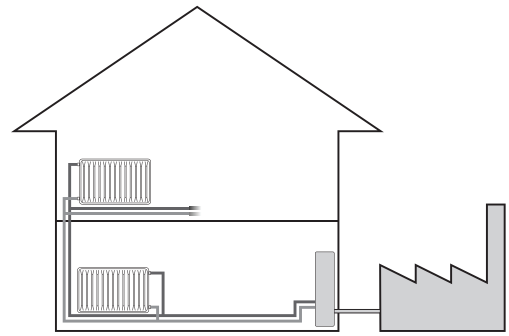

Recommendations

Weather compensation / ECL

If the boiler's heating curve is set to have the radiator thermostats on comfort temperature constantly, the curve must be increased in order to be able to raise the room temperature after a setback period.

- If the setback periods are long, further increase might be necessary.
- If the economy periods are short, less increase can be sufficient.

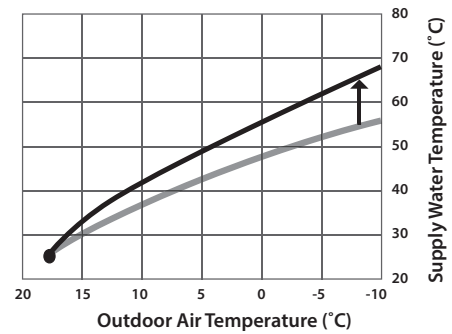

3.4 Heat Pump

Description

A heat pump is generating heating by transferring heat from a relatively low-temperature reservoir, such as air or ground, to one at a higher temperature.

Min. requirements

- ▶ min. 40 °C supply temperature at the valve.
- ▶ sufficient heating capacity to increase the room temperature with 1 °C per hour.
- ▶ only radiator valves approved for Danfoss adapters.

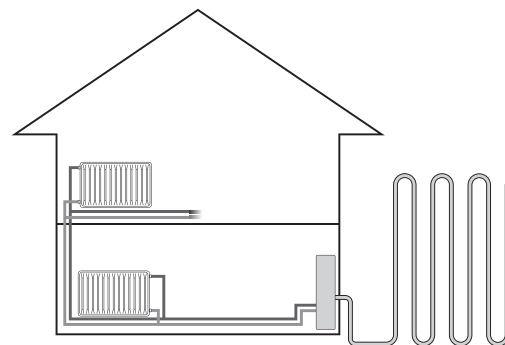

Recommendations

Weather compensation

If the heat pump's heating curve is set to have the radiator thermostats on comfort temperature constantly, the curve must be increased in order to be able to raise the room temperature after a setback period.

- If the setback periods are long, further increase might be necessary.
- If the economy periods are short, less increase can be sufficient.

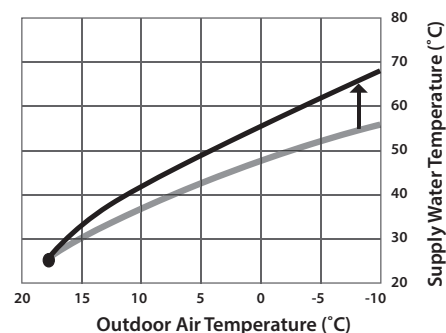

If system is installed during period with outside temperature > 10° C opening point will not be found until temperature drops below 7-8° C. Can be solved by manually setting the heating curve higher during the run in period (approx. 1 week).

