

ENGINEERING  
TOMORROW

*Danfoss*



Installation and User Guide

**eco Intelligent Radiator Thermostat**

## Installation Guide

### 1. Installation

1.1	Identify your eco thermostat.....	4
1.2	In the package.....	4
1.3	Overview of valve adapters.....	5
1.4	Installing the right adapter.....	6
1.5	Inserting the batteries.....	7
1.6	Using the buttons.....	7
1.7	Setting time and date for the first time.....	8
1.8	Installing eco.....	8
1.9	Automatic adjustments.....	9
1.10	Removing eco.....	9
1.11	Resetting eco to default settings.....	10
1.12	Removing an adapter from eco.....	10

2.	Technical specifications.....	11
----	-------------------------------	----

## User Guide

### 3. Display and menus

3.1	Home Screen .....	12
3.2	Programme menu.....	12
3.3	Function menu.....	13
3.4	Advanced menu .....	14
3.5	Pause .....	15

### 4. Temperature and programme settings

4.1	Setting the comfort temperature .....	16
4.2	Default programme settings .....	17
4.3	Adjusting programme setting P1 .....	18
4.4	Adjusting programme setting P2 .....	19
4.5	Creating a Travel programme.....	19
4.6	Override a Travel programme (early return) .....	20
4.7	Changing an existing Travel programme .....	21
4.8	Deleting a Travel programme.....	21
4.9	Adjusting the Pause temperature .....	22

### 5. Additional settings

5.1	Setting the time.....	23
5.2	Deactivating automatic daylight saving time.....	23
5.3	Setting the Heating Control .....	24
5.4	Automatic valve exercising .....	25
5.5	Activating intelligent Control (Forecast).....	25
5.6	Limiting the temperature setting range .....	26
5.7	Child Lock .....	26
5.8	Pause .....	26
5.9	Open-window function .....	27

### 6. Safety precautions..... 27

### 7. Disposal .....

## 1. Installation

### 1.1 Identify your eco thermostat

eco comes in several versions to meet the demands of different markets.

You identify your version by the code number on the box label. Adapters for a range of different valves types are available as accessories, see chapter 1.3. comes in several versions to meet the demands of different markets. To identify your version, see the code number on the box label.

Adapters for a range of different valves types are available as accessories, see chapter 1.3.

Code no.	Version characteristics	Quick guide languages
<b>014G0065</b>	Incl. pre-mounted RA adapter (Default MODERATE and FORECAST ON in software setting)	UK/DK/SE/FI/LT/EE/LV/IS
<b>014G0051</b>	Incl. RA + M30 x 1.5 adapters (Default MODERATE and FORECAST OFF in software setting)	UK/DK/SE/FI/LT/EE/LV/IS
<b>014G0064</b>	Incl. RA + M30 x 1.5 adapters, Forecast disabled as default (Default QUICK and FORECAST OFF in software setting)	UK/DE/FR/PL/NL/NO/CZ/HU/SK/SI/ES/IT

### 1.2 In the package

eco are supplied with the adapters as listed above. In addition each pack contains:

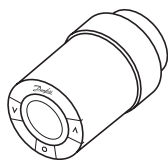

eco sensor



Quick Guide

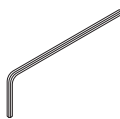



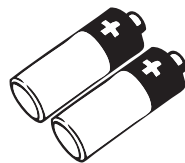



Allen key, 2 mm

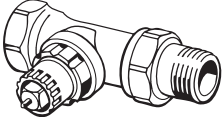

Alkaline AA batteries

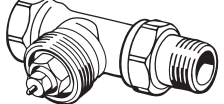
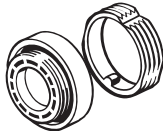
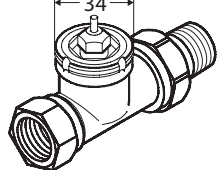
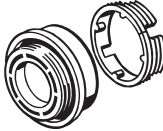
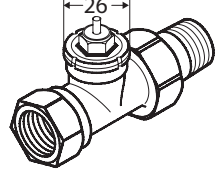
### 1.3 Overview of valve adapters

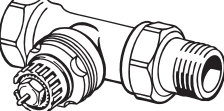
Adapters for a wide range of different valve types are available as accessories.

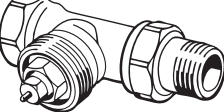
Adapter type	Code no.	Adapter	Valve
For Danfoss RA valves	014G0251		
For M30 x 1.5 (K) valves	014G0252		
For Danfoss RAV valves	014G0250		
For Danfoss RAVL valves			
For Danfoss RTD valves	014G0253		
For M28 valves: - MMA - Herz - Orkli - COMAP	014G0255 014G0256 014G0257 014G0258		

### 1.4 Installing the right adapter

#### Adapter for RA valves

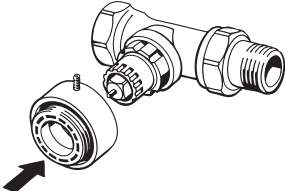
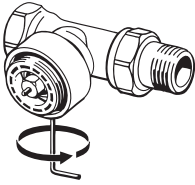
<p>1.</p>  <p>Place the RA adapter on the valve as shown.</p>	<p>2.</p>  <p>Tighten the adapter with the 2 mm Allen key.</p>
--	---

#### Adapter for M30 x 1.5 (K) valves

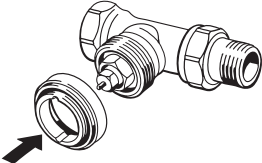
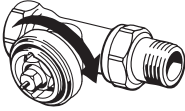
<p>1.</p>  <p>Place the K adapter on the valve as shown.</p>	<p>2.</p>  <p>Hand-tighten the K adapter (max. 5 Nm).</p>
---	--

#### Adapter for RAV valves (accessory)

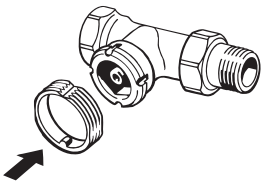
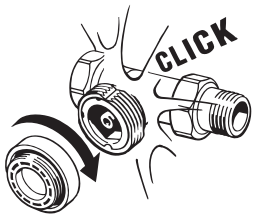
<p>1.</p>  <p>Click the inner adapter on the valve.</p>	<p>2.</p>  <p>Hand-tighten the outer adapter (max. 5 Nm).</p>
---	---

#### Adapter for RAVL valves (accessory)

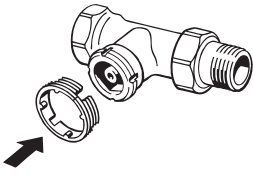
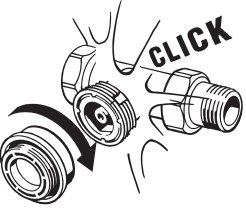
<p>1.</p>  <p>Click the inner adapter on the valve.</p>	<p>2.</p>  <p>Hand-tighten the outer adapter (max. 5 Nm).</p>
--	--

**Adapter for RTD valves (accessory)**

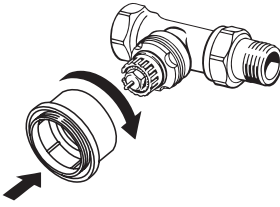
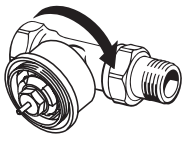
<p>1.</p>  <p>Place the RTD adapter on the valve as shown.</p>	<p>2.</p>  <p>Hand-tighten the RTD adapter (max. 5 Nm).</p>
---	--

**Adapters for M28 valves (accessories)**

Please follow the instructions supplied with the valve adapter for the specific M28 valve.

**1.5 Inserting the batteries**

Remove the battery cover and insert two AA batteries. Make sure the batteries are correctly oriented.

Rechargeable batteries **must not** be used.

When replacing batteries the programme settings will be preserved, but after two minutes the settings for time and date are reset.

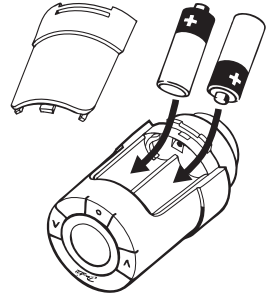



The low battery symbol  is displayed approx. one month before the batteries run out.

After approx. two weeks the  symbol will flash 14 times from 19:00 to 21:00 hrs.

Before the batteries run out eco will leave the valve in Frost Protection position to protect the heating system from damage.

**1.6 Using the buttons**



eco has two arrow buttons   which allow you to navigate the display and the menus and to set the temperature.

The middle button  is used to select and confirm.

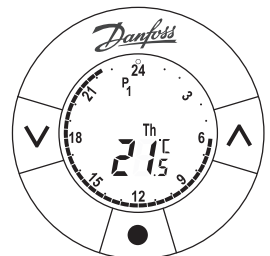

If the display is off, press either button to activate the display.



### 1.7 Setting time and date for the first time

<p>1.</p>  <p>When the batteries are installed the time flashes on the display - 23:59.</p> <ol style="list-style-type: none"> <li>Set hours with  , press  to confirm.</li> <li>Set minutes with  , press  to confirm.</li> <li>Set date with  , press  to confirm.</li> </ol>	<p>2.</p>  <p>When  flashes, press  to confirm your settings. The display now switches to the Installation Mode a large  flashes on the screen.</p>
--	--

### 1.8 Installing eco

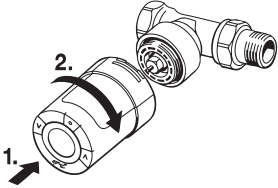
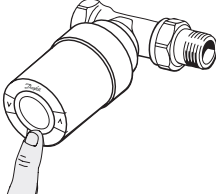
<p>1. <i>Note! Activate Installation Mode</i></p>  <p>Ensure you are in Installation Mode before you mount eco. If not, press  for 4 seconds.</p>	<p>2.</p>  <p>A large  is flashing in the display to indicate that Installation Mode is activated.</p>
<p>3.</p>  <p>Screw eco onto the adapter and tighten by hand (max. 5 Nm). While slightly pressing forward, turn eco clockwise until it locks, then tighten.</p>	<p>4.</p>  <p>Press  for 4 seconds to fix eco.</p>

### 1.9 Automatic adjustments

When eco is installed it will automatically begin to adjust itself to your heating system. During this process you might experience that the thermostat reacts slowly or turns the heat up and down by itself. This is normal and a necessary part of the adjustment process.

#### 1. Adjusting to the valve

During the first night of operation eco will shut off the radiator heat and then open again to detect the exact opening point of the valve. This will allow eco to control the heat as efficiently as possible. If necessary, the procedure is repeated once a night for up to a week.





#### 2. Intelligent Control (Forecast)

If you activate Intelligent Control eco learns during the first week of operation when it is necessary to start heating the room in order to reach the correct temperature at the correct time.

The intelligent control will continuously adjust the heating time compared to seasonal temperature changes. To activate Intelligent Control see chapter 5.5.

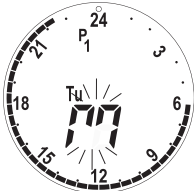
Using Saving Program requires that your heating system has enough heat for a short period during heat up. If your experience problems you should contact your installer.

### 1.10 Removing eco

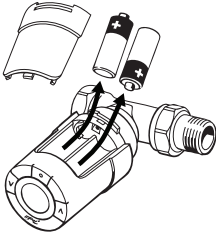
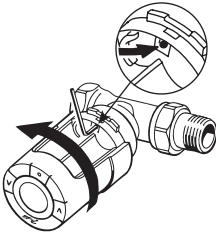
<p>1.</p>  <p>Activate Installation Mode: Press  for 4 seconds. When <i>m</i> flashes, press .</p>	<p>2.</p>  <p>A large <i>m</i> is flashing in the display to indicate that Installation Mode is activated.</p>
<p>3.</p>  <p>Remove the battery cover and the batteries.</p>	<p>4.</p>  <p>Insert the Allen key or similar into the hole to lock the adapter ring. Turn counterclockwise to unscrew eco from the adapter.</p>

## 1.11 Resetting eco to default settings

1.

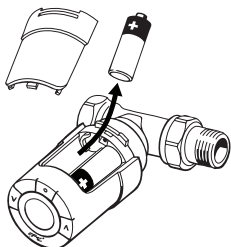

Remove the battery cover and take out one battery.

2.

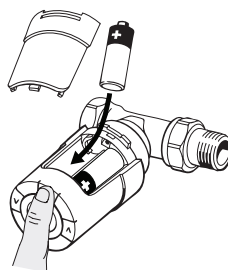

Press and hold , Keep holding while reinserting the battery. The screen will show all functions then return to a large flashing *m*.

## 1.12 Removing an adapter from eco

1.

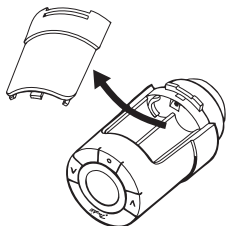

Remove the battery cover.

2.

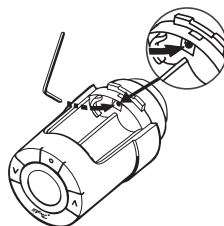

Insert a small Allen key or similar into the locking hole to lock the adapter ring.

3.

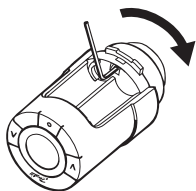

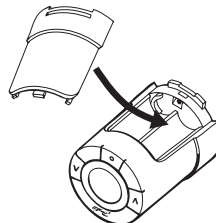

With the Allen key locking the adapter ring, turn the adapter in the shown direction.

4.



Put back the battery cover. Mount eco on another valve adapter according to the instructions supplied with the adapter.

## 2. Technical specifications

Thermostat type	Programmable electronic radiator valve controller
Recommended use	Residential (pollution degree 2)
Actuator	Electromechanical
Display	Grey digital with backlight
Software classification	A
Control	PID
Power supply	2 x 1.5 V alkaline AA batteries (not included)
Power consumption	3 $\mu$ W in standby 1.2 W when active
Battery life	Up to 2 years
Low battery signal	Battery icon will flash in display. If battery level is critical, the whole display will flash.
Ambient temperature range	0 to 40 °C
Transportation temperature range	-20 to 65 °C
Maximum water temperature	90 °C
Temperature setting range	4 to 28 °C
Measurement interval	Measures temperature every minute
Clock accuracy	+/- 10 min/year
Spindle movement	Linear, up to 4.5 mm, max. 2 mm on valve (1 mm/s)
Noise level	<30 dBA
Safety classification	Type 1
Weight (incl. batteries)	177 g (with RA adapter)
IP class	20 (not to be used in hazardous installations or in places where it will be exposed to water)
Approvals, markings etc.	  



### 3. Display and menus

#### 3.1 Home Screen

When pressing  the Home Screen appears with basic information on programming and operation of eco:

Time is shown with the dashed circle, each segment representing 30 minutes.

- Black segments = periods with comfort temperature.
- White segments = periods with setback temperature.
- Flashing segment = current time.

The chosen programme P0, P1, P2,  (Travel) or  (Pause)





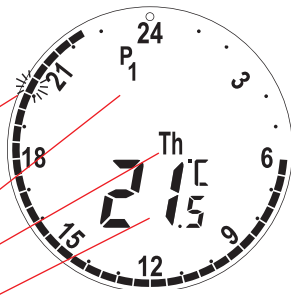

Day of week

The set temperature\*

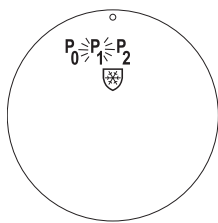

\* eco is displaying the **set temperature**, not the **measured room temperature**.

#### 3.2 Programme menu







<p>1.</p> 	<p>To select the Programme menu: If the display is off, press , then press  again to open the programme menu. Use   to shift between the programmes, press  to confirm. The chosen programme is flashing.</p>
--	---

#### Display symbols in the Programme menu

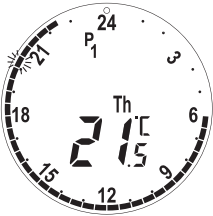

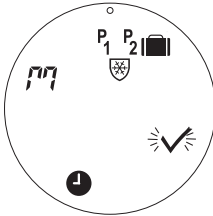

<b>P0</b>	Programme without automatic temperature reduction. This programme maintains the comfort temperature of 21 degrees constant all day and night.
<b>P1</b>	Saving programme which as default lowers the temperature to 17 °C at night (22:30 - 06:00 hrs). Time and temperature are configurable.
<b>P2</b>	Extended saving programme which as default lowers the temperature to 17 °C at night (22:30 - 06:00 hrs), and during the day on weekdays (08:00 - 16:00 hrs). Time and temperature are configurable.
	Pause program. The thermostat will maintain a constant temperature of 4-10 °C in the room, ensuring frost protection.

*Note! Symbols must be flashing to be activated.*

### 3.3 Function menu





<p>1. </p> <p>To select the Function menu: If the display is off, press , then press both   and hold for 3 seconds.</p>	<p>2. </p> <p>Use   to shift between functions.</p>
---	--

#### Display symbols in the Function menu



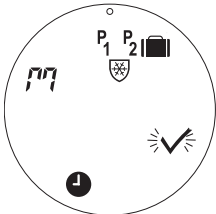

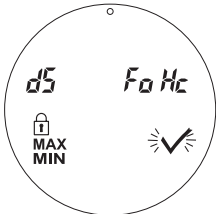

	Installation Mode must always be activated when installing or removing eco. The thermostat may be irreparably damaged if not in the correct position during installation.
	Travel programme which lowers the temperature when you are away. Date, time and temperature are configurable.
	Set time and date - see chapter 5.1.
<b>P1</b>	Saving programme, adjust the default settings. Time and temperature are configurable, weekdays and weekend days.
<b>P2</b>	Extended saving programme, adjust the default settings. Time and temperature are configurable, weekdays and weekend days.
	Pause programme. To set the default Pause temperature.

*Note! Symbols must be flashing to be activated.*

### 3.4 Advanced menu







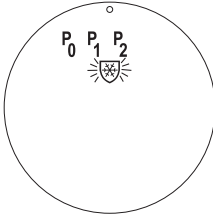

<p>1.</p>  <p>To select the Advanced menu: If the display is off, press , then press  and hold for 3 seconds to open the Function menu.</p>	<p>2.</p>  <p>Press both   buttons for 3 seconds to open the Advanced menu.</p>
--	--

#### Display symbols in the Advanced menu

	Confirm selection.
	Deactivate/activate automatic daylight saving time - see chapter 5.2.
	Deactivate/activate intelligent control (Forecast) - see chapter 5.5.
	Select moderate or quick heating control - see chapter 5.3.
	Set the max and min temperature range - see chapter 5.6
	Child Lock - see chapter 5.7

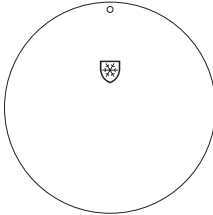
*Note! Symbols must be flashing to be activated.*

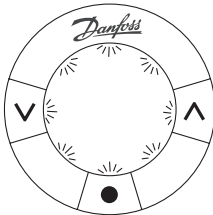





3.5 Pause

<p>1.</p>  <p>To activate Pause from the <b>programme menu</b>. If the display is off, press . Press  again to open the Programme menu. The Pause symbol is flashing .</p>	<p>2.</p>  <p>To confirm you want to set the eco into Pause, press .</p>
<p>3.</p>  <p>The whole display will blink slowly to indicate that Pause is activated.</p>	<p>4.</p>  <p>To leave Pause press  twice, the eco will return to the home screen.</p>

*Note! The default pause temperature is 6 °C, to adjust the pause temperature see chapter 4.9.*

## 4. Temperature and programme settings

### 4.1 Setting the comfort temperature

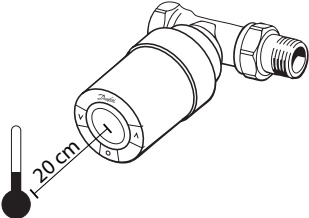
<p>1.</p>  <p>If the display is off, press . Use the   buttons to raise or lower the comfort temperature (default temperature 21 °C). eco will maintain the new comfort temperature until the next setback or comfort period.</p>	<p>2.</p>  <p>If the temperature is changed during a setback period (default 17 °C), the new temperature will only be valid for this setback period. For a permanent change of the setback temperature, see chapter 4.3.</p>
<p>3.</p>  <p>If the comfort temperature is set at its lowest, the MIN and temperature show, indicating the minimum constant temperature.</p>	<p>4.</p>  <p>eco is measuring the temperature with two built-in sensors - one behind the display and one near the valve. Based on both readings the room temperature is calculated for an area approx. 20 cm in front of the display. This allows eco to control the actual room temperature very accurately. Be aware that sources of cold or heat, e.g. fireplace, direct sun or draft, might affect the function of eco.</p>

*Note! If the set temperature is raised more than 1 °C eco will boost the radiator heat to reach the new temperature faster. You can feel the valve and radiator are getting warmer.  
Minor temperature changes will not evoke a heat boost, and so the changes are made without any immediate indication.*

## 4.2 Default programme settings

### Programme P<sub>0</sub>

This programme is without automatic temperature reduction. It will maintain the temperature at a constant comfort level all day and night.

The default comfort temperature is 21 °C, but can be adjusted to any level between 6 and 28 °C.

0	3	6	9	12	15	18	21	24
21 °C								

### Programme P<sub>1</sub>

This is the default savings programme, which has a comfort temperature of 21 °C and one setback period from 22:30 to 6:00 hrs with a temperature of 17 °C. Time and temperature are configurable for both comfort and setback periods.

0	3	6	9	12	15	18	21	24
17 °C		21 °C						17 °C

### Programme P<sub>2</sub>

This is the extended savings programme with a setback period from 22:30 to 6:00 hrs and an additional setback period from 8:00 to 16:00 hrs on weekdays. Time and temperature are configurable for both comfort and setback periods.

*Weekdays:*

0	3	6	9	12	15	18	21	24
17 °C		21 °C	17 °C			21 °C		17 °C

*Weekend:*

0	3	6	9	12	15	18	21	24
17 °C		21 °C						17 °C

### Travel Programme

This programme keeps the setback temperature ( default 17 °C) all day and night. Use the programme to save energy, when you are away from home. Time and temperature are configurable.

0	3	6	9	12	15	18	21	24
17 °C								











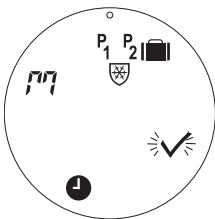





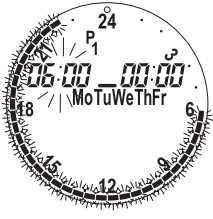

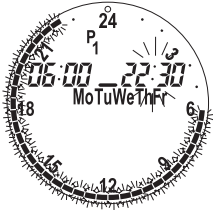

### Pause Programme

This programme keeps a low temperature ( default 6 °C) all day and night. Use the programme to prevent damage of the radiator, when you are away from home. The temperature is configurable.

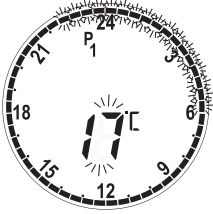
0	3	6	9	12	15	18	21	24
6 °C								

### 4.3 Adjusting the programme settings, P1

Change the default P1 and P2 programmes to your own schedule and preferred time and temperature settings.

<p>1.</p>  <p>If the display is off, press , then press and hold both  and  for 3 seconds to open the Function menu. Use  to select P1 programme. When the chosen programme is flashing, press  to confirm.</p>	<p>2.</p>  <p>Start time for weekday comfort period is flashing. Use  to set the start time, press  to select.</p>
<p>3.</p>  <p>Stop time for the comfort period is flashing. Use  to set the stop time, press  to select. Once the time is chosen, press  to confirm.</p>	<p>4.</p>  <p>Comfort temperature is flashing. Use  to set the comfort temperature, press  to select.</p>
<p>5.</p>  <p>The setback temperature is flashing. Use  to set the setback temperature, confirm using .</p>	<p>6.</p>  <p>Start time for weekend comfort period is flashing. Use  to set the start time, press  to select.</p>

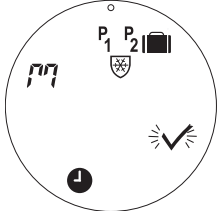
<p>5.</p>  <p>Stop time for the weekend comfort period is flashing. Use   to set the stop time, press  to select.</p>	<p>6.</p>  <p>When  flashes, press  to confirm the entire P1 Programme.</p>
--	--



#### 4.4 Adjusting the programme settings, P<sub>2</sub>



eco P<sub>2</sub> programme is adjusted as P1.

*Note - Weekdays have 2 comfort periods.*

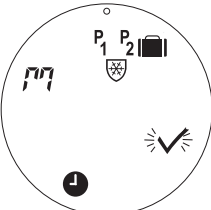
#### 4.5 Creating a Travel programme

A Travel programme keeps the setback temperature for a period, defined by you. Use a Travel programme to save energy, when you are away from home.

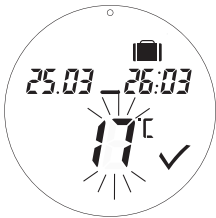
<p>1.</p>  <p>If the display is off, press , then press both   and hold for 3 seconds to open the function menu. Use   to select . When the suitcase symbol flashes, press  to confirm.</p>	<p>2.</p>  <p>The current day is flashing. Use   to set the day of departure, press  to confirm. Now the current month is flashing. Use   to set the month of departure, press  to confirm.</p>
--	--







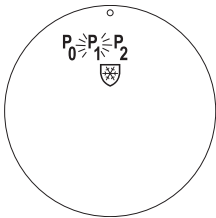



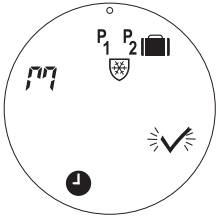

<p>3.</p>  <p>The day of return is flashing. Use   to set the day of return, press  to confirm. Now the month of return is flashing. Use   to set the month of return, press  to confirm.</p>	<p>4.</p>  <p>The setback temperature is flashing. Use   to set the setback temperature, press  to confirm.</p>
<p>5.</p>  <p>✓ flashes, press  to confirm your Travel programme.  is now displayed on the Home Screen.</p>	<p>6.</p>  <p>When the date of departure arrives, the display will show: , set Travel period and the setback temperature.</p>

#### 4.6 Overrule a Travel programme (early return)







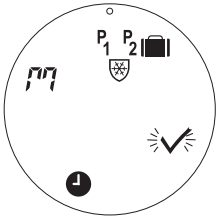

If returning earlier than expected you might wish to shift from the Travel programme to your normal programme.

<p>1.</p>  <p>If the display is off, press . The display will show: , set Travel period and the setback temperature.</p>	<p>2.</p>  <p>Press  again to open the programme menu. Use   to select the usual programme P0, P1 or P2, press  to confirm.</p>
---	--

### 4.7 Changing an existing Travel programme



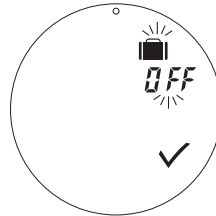







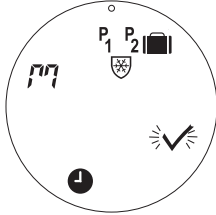



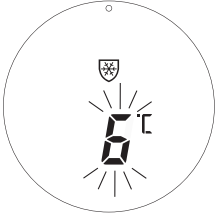

<p>1.</p>  <p>If the display is off, press , then press both  and  and hold for 3 seconds to open the function menu. Use  to select , press  to confirm.</p>	<p>2.</p>  <p>The day of departure is flashing, change with . Press  to confirm your changes and shift to the next value. When the necessary changes are made, press  to confirm.</p>
<p>3.</p>  <p>✓ now flashes. Press  to confirm your changes of the Travel programme.</p>	

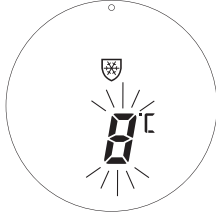
### 4.8 Deleting a Travel programme

<p>1.</p>  <p>If the display is off, press , then press both  and  and hold for 3 seconds to open the function menu. Use  to select , press  to confirm.</p>	<p>2.</p>  <p>Use  to select <i>OFF</i>, press  to confirm.</p>
---	--

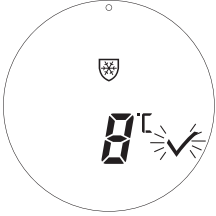









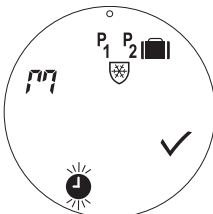















### 4.9 Adjusting the Pause temperature

The Pause programme keeps the setback temperature until another programme is selected.











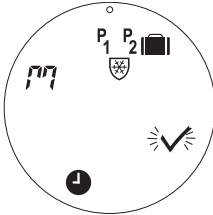



<p><b>1.</b></p>  <p>If the display is off, press , then press both  and  and hold for 3 seconds to open the function menu.</p> <p>Use  to select . When the Pause symbol flashes, press  to confirm.</p>	<p><b>2.</b></p>  <p>The Pause temperature is set at 6°C as default, if okay press  to confirm.</p>
<p><b>3.</b></p>  <p>To change the Pause temperature use  and  arrows. When you have chosen your Pause temperature, press  to confirm.</p>	<p><b>4.</b></p>  <p>To leave Pause, use  and  arrows select  to return to the Function menu.</p>

## 5. Additional settings

### 5.1 Setting the time

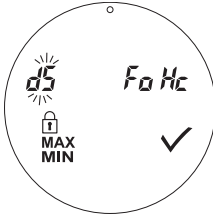
<p>1.</p>  <p>If the display is off, press , then press both   to open the function menu. Use   to select , press  to confirm.</p>	<p>2.</p>  <p>Hours flashes, use   to set and press  to confirm. Then Minutes flashes, use   to set and press  to confirm.</p>
<p>3.</p>  <p>Date flashes, use   to set and press  to confirm. Then Month flashes, use   to set and press  to confirm. Then Year flashes, use   to set and press  to confirm.</p>	<p>4.</p>  <p>✓ flashes. Press  to confirm your changes of time and date.</p>

### 5.2 Deactivating automatic daylight saving time

<p>1.</p>  <p>If the display is off, press , then press both   to open the function menu. Press   again to open the advance menu. Use   to select , press  to confirm.</p>	<p>2.</p>  <p>Use   to select , press  to confirm.</p>
---	---

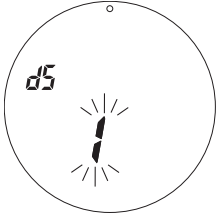
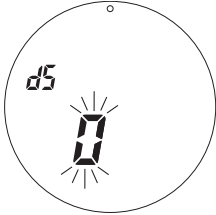
<p>3.</p>  <p>1 flashes, indicating automatic daylight saving time is <b>on</b>. Use <math>\leftarrow</math> to shift to 0, press <math>\rightarrow</math> to confirm.</p>	<p>4.</p>  <p>0 flashes, indicating automatic daylight saving time is <b>off</b>. Press <math>\rightarrow</math> to confirm.</p>
---	---

Note: Default is set at Daylight Saving ON

### 5.3 Setting the Heating Control

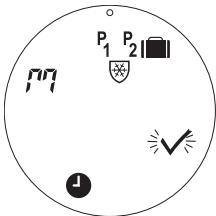
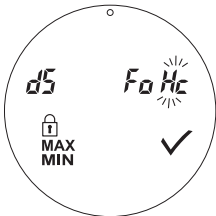
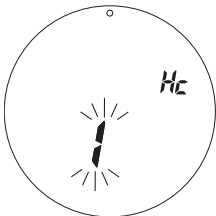
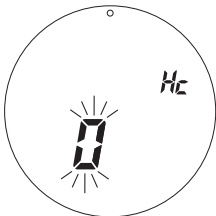
<p>1.</p>  <p>If the display is off, press <math>\rightarrow</math>, then press both <math>\leftarrow</math> to open the function menu. Press <math>\leftarrow</math> again to open the advance menu. Use <math>\leftarrow</math> to select <b>Hc</b>, press <math>\rightarrow</math> to confirm.</p>	<p>2.</p>  <p>Use <math>\leftarrow</math> to select <b>Hc</b>, press <math>\rightarrow</math> to confirm.</p>
<p>3.</p>  <p>1 flashes, indicating moderate heating response is selected (recommended for district heating). Use <math>\leftarrow</math> to shift to 0, press <math>\rightarrow</math> to confirm.</p>	<p>4.</p>  <p>0 flashes, indicating quick heating response is selected (recommended for all boilers), press <math>\rightarrow</math> to confirm.</p>











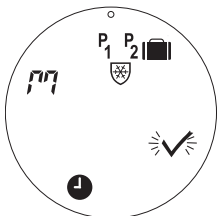





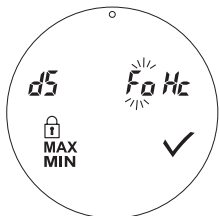

Note: Note: Default setting is dependant on the code number - please see table in chapter 1.1

## 5.4 Automatic valve exercising



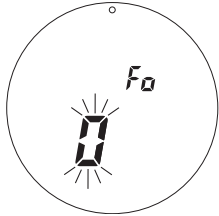
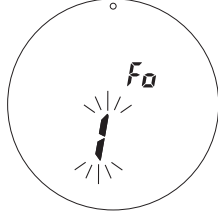







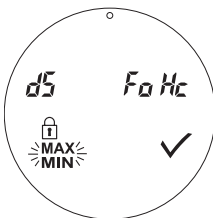



To keep the radiator valve functional and at its best, eco automatically exercises the valve every Thursday at approx. 11:00 hrs by opening it fully and then return to normal setting.

## 5.5 Activating Intelligent Control (Forecast)

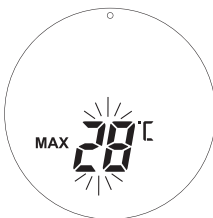
The Intelligent Control (Forecast) ensures that eco reaches the comfort temperature on time, according to the settings. The default is set to off. (Except for code number 014G0065 where forecast default is set as ON)











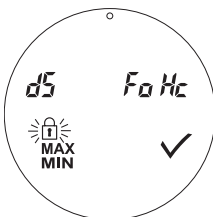



<p>1.</p>  <p>If the display is off, press , then press both   to open the function menu. Press   again to open the advance menu. Use   to select <b>FD</b>, press  to confirm.</p>	<p>2.</p>  <p>Press both   buttons for 3 seconds, use   to select <b>FD</b> and press  to confirm.</p>
<p>3.</p>  <p><b>0</b> flashes, indicating the Forecast is off. (default setting is off).</p>	<p>4.</p>  <p>Use   to shift to <b>1</b>, indicating the Forecast is activated. Press  to confirm.</p>

### 5.6 Limiting the temperature setting range





<p>1.</p>  <p>If the display is off, press , then press both   to open the function menu. Press   again to open the advance menu. Use   to select MAX/MIN, press  to confirm.</p>	<p>2.</p>  <p>Use   to set MAX temperature, press  to confirm. Use   to set MIN temperature, press  to confirm.</p>
--	--

### 5.7 Child Lock

Protect your eco settings from tampering by activating the Child Lock.

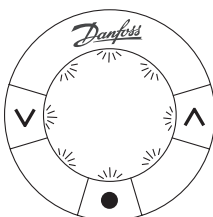
<p>1.</p>  <p>If the display is off, press , then press both   to open the function menu. Press   again to open the advance menu. Use   to select , press  to confirm.</p>	<p>2.</p>  <p> is shown on the Home Screen, indicating Child Lock is <b>on</b>. Deactivate Child Lock by pressing all three buttons    <b>simultaneously</b> for 5 seconds.</p>
--	---

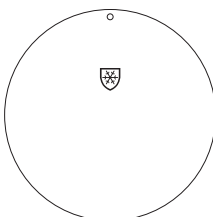
### 5.8 Pause Function

<p>1.</p>  <p>To Pause the system, press , to activate the display. Press  twice, this now sets eco into Pause. The display will flash slowly to indicate that Pause is activated.</p>	<p>2.</p>  <p>To disable the Pause, press  to activate the display, then  twice, to disable Pause.</p>
---	---

## 5.9. Open-window function

eco features an Open-window function, which closes the valve if the room temperature is falling dramatically, thus reducing the heat loss.

The heat is turned off for up to 30 minutes, before eco returns to its original settings.

When Open-window has been activated, the function is quarantined for 45 minutes.

*Note! Be aware that the Open-window function will be affected, if curtains or furniture are covering eco, preventing it from detecting the decreasing temperature.*

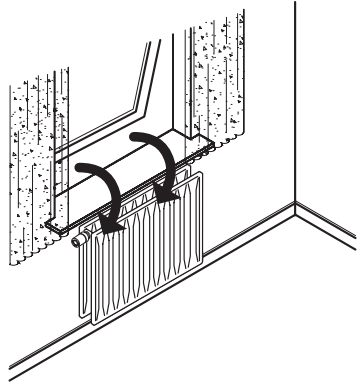

## 6. Safety precautions

The thermostat is not intended for children and must not be used as a toy.

Do not leave packaging materials where children may be tempted to play with them, as this is extremely dangerous.

Do not attempt to dismantle the thermostat as it contains no user-serviceable parts. If error code E1, E2 etc. is shown in the display or other defects appear, please return the thermostat to the distributor.

## 7. Disposal

The thermostat must be disposed of as electronic waste.



---

**Danfoss A/S**

Haarupvaenget 11

DK-8600 Silkeborg

Denmark

Phone: +45 7488 8000

Fax: +45 7488 8100

[www.danfoss.com](http://www.danfoss.com)