

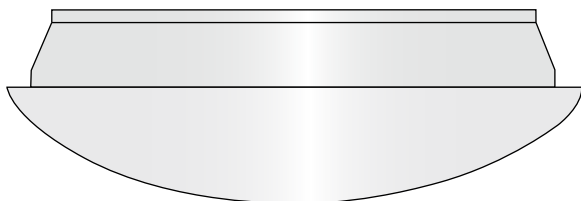

Saves Your Energy

PEM 292  
1.12.2015



AVR320 - series



AVR320 LED - series

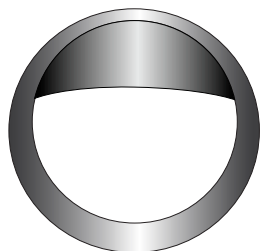

AVL46

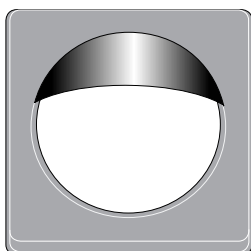

AVL49

- FIN** Asennusohje
- SWE** Installationsanvisning
- ENG** Installation instruction
- DEU** Montageanweisung
- FRA** Instruction d'installation
- CZE** Návod k montáži
- LAV** Montāžas instrukcija
- LIT** Montavimo instrukcija
- POL** Instrukcja montażu
- EST** Paigaldusjuhend
- ITA** Istruzioni per l'installazione
- NOR** Installasjonsinstruksjoner
- UKR** Інструкції з установки
- RUS** Руководство по монтажу



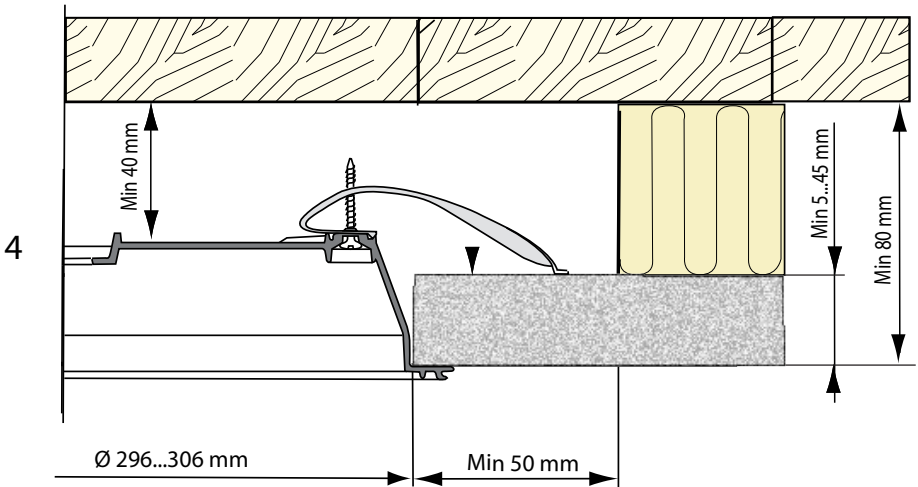
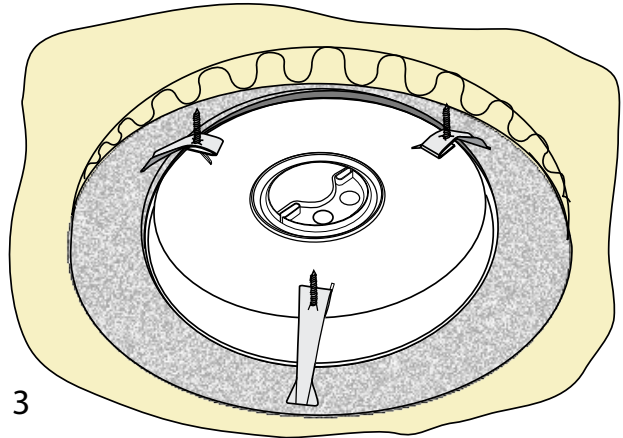
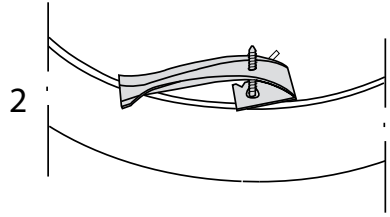
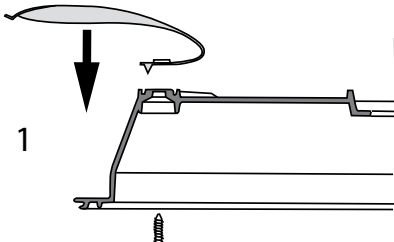

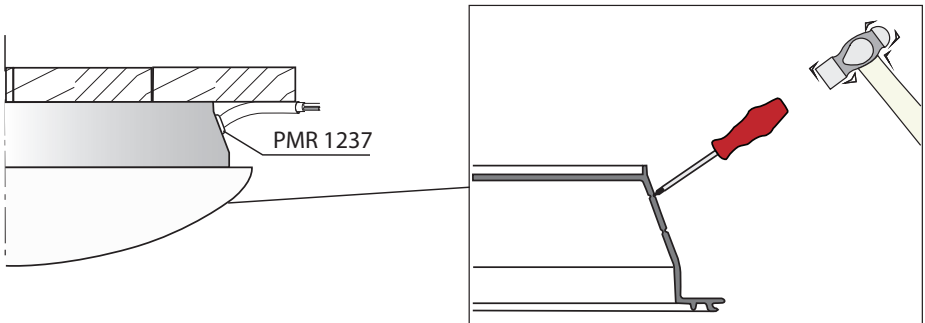
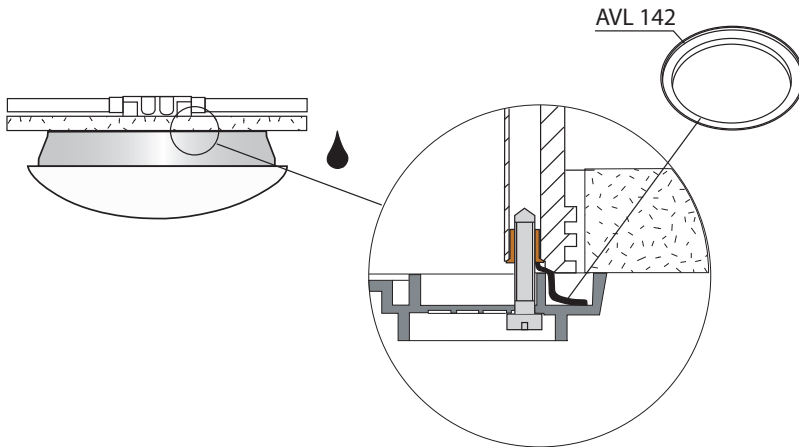
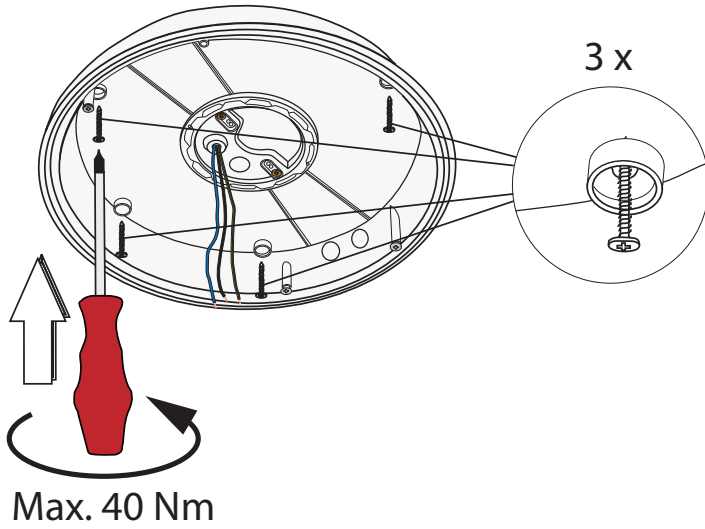

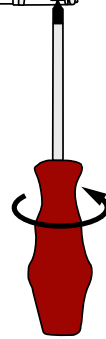
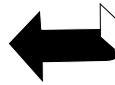
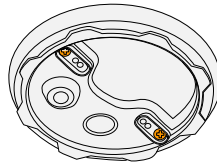
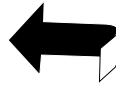
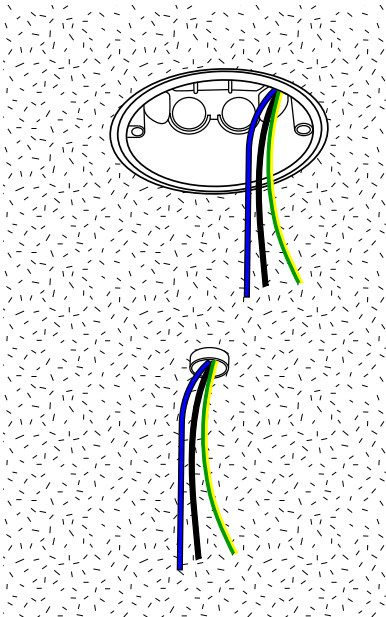
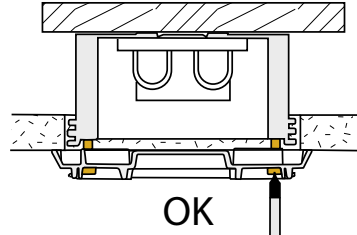
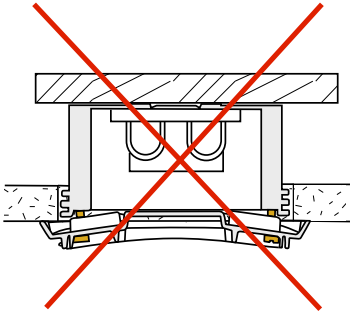

Max. 10 Nm

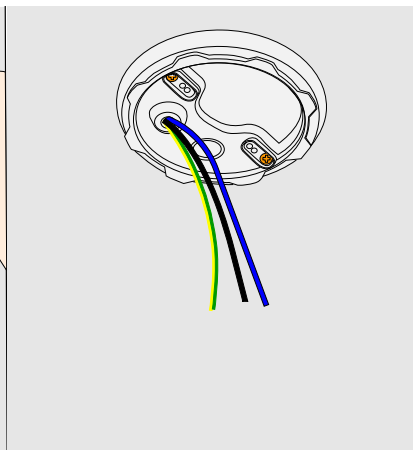
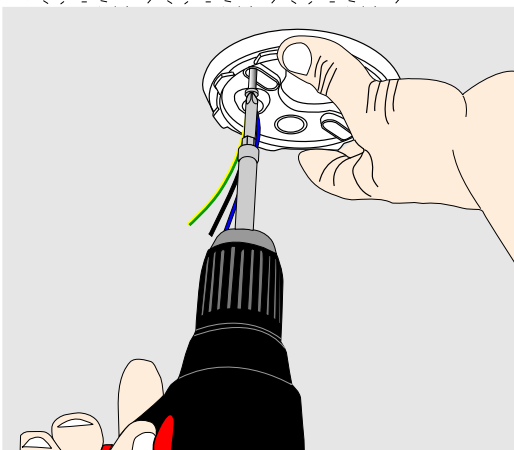

1

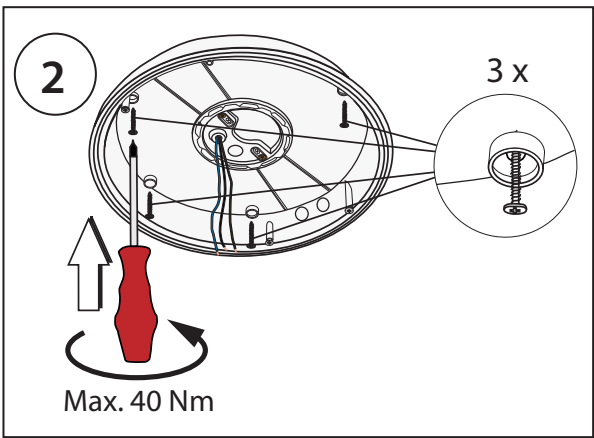
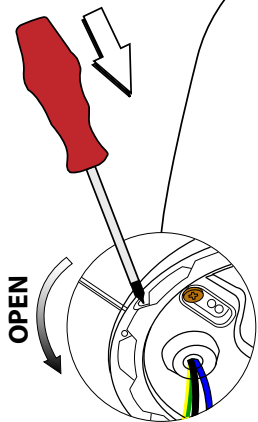
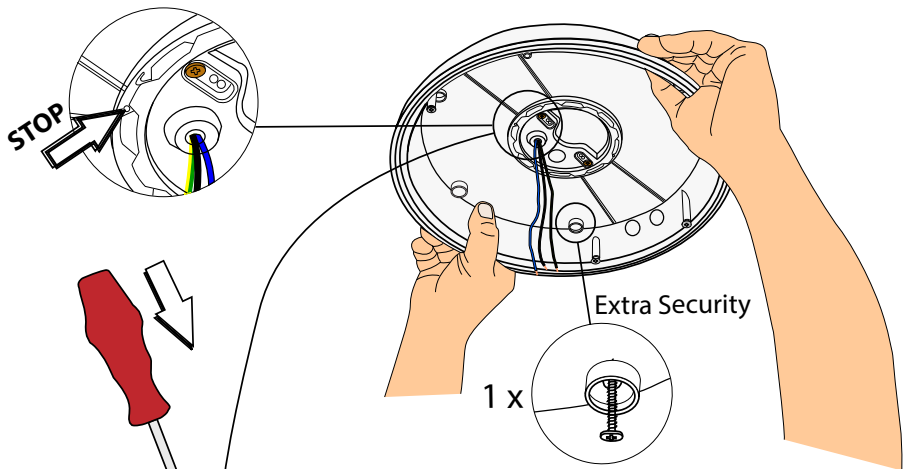
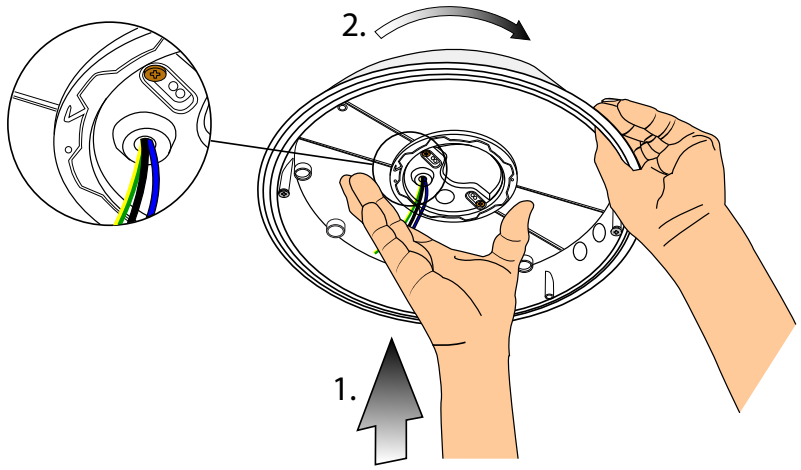

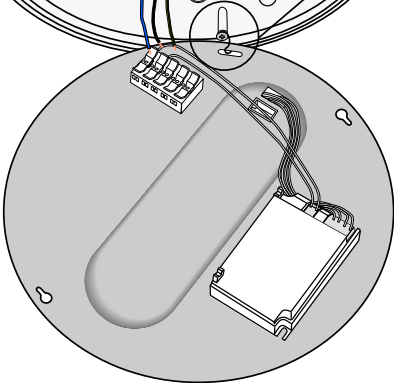
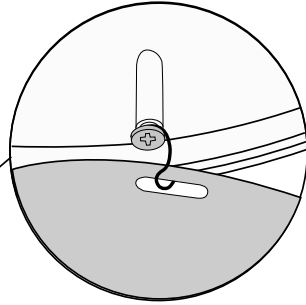
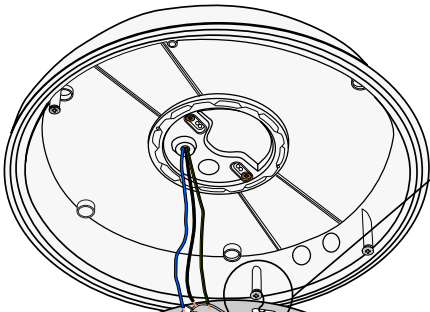
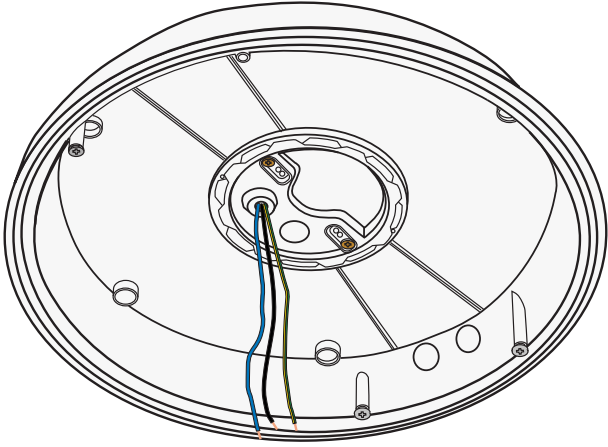

**PIR  
RADAR**

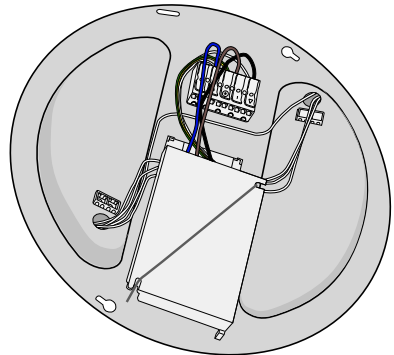

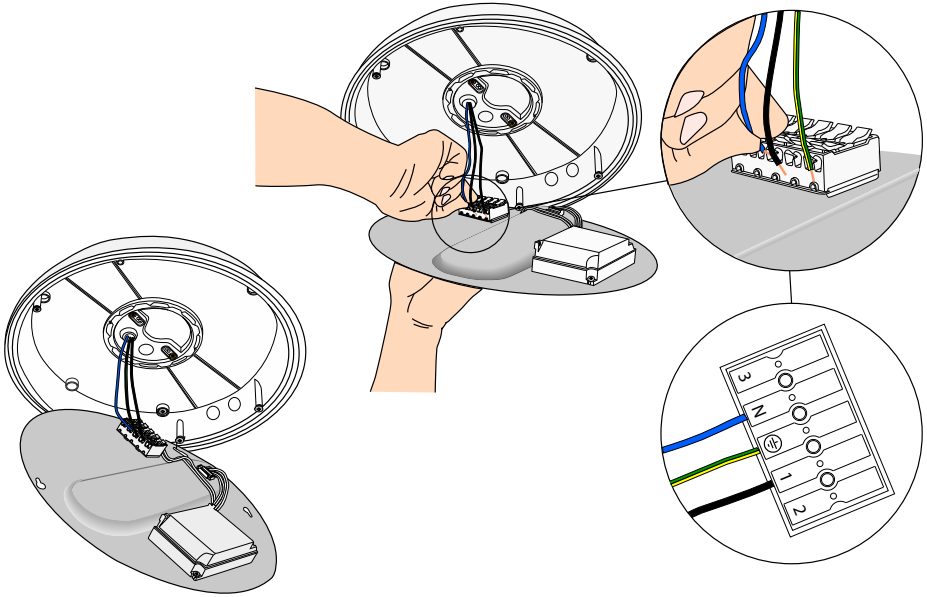

---

## PIR RADAR

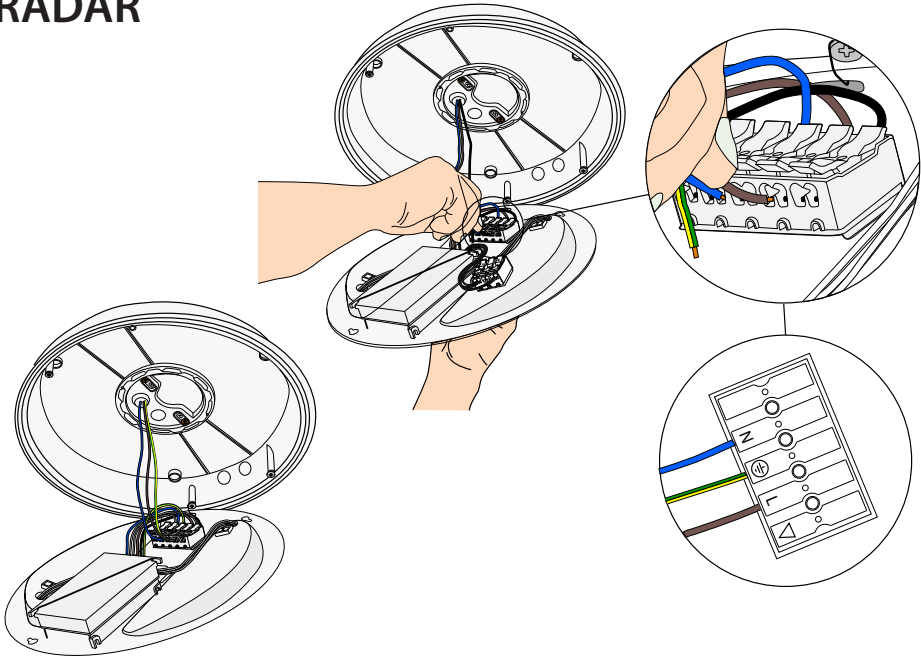

# LED

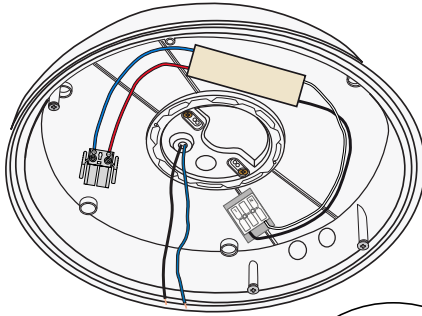

1 - 10V

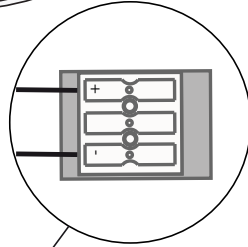
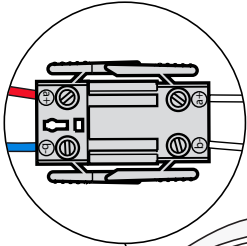

DALI / switchDIM

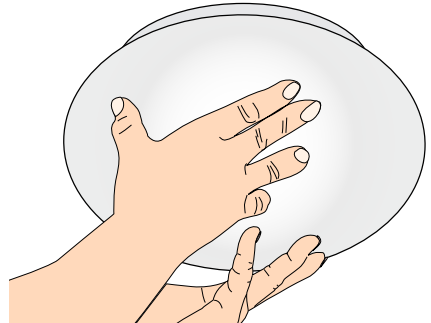
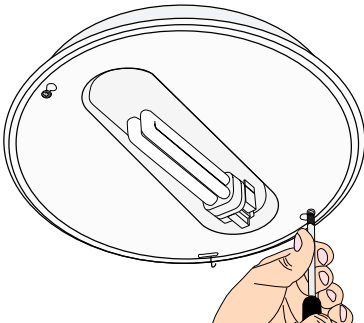
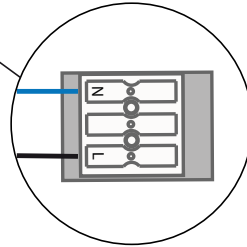
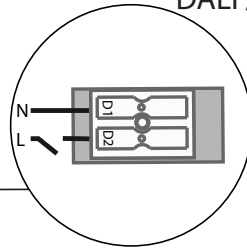
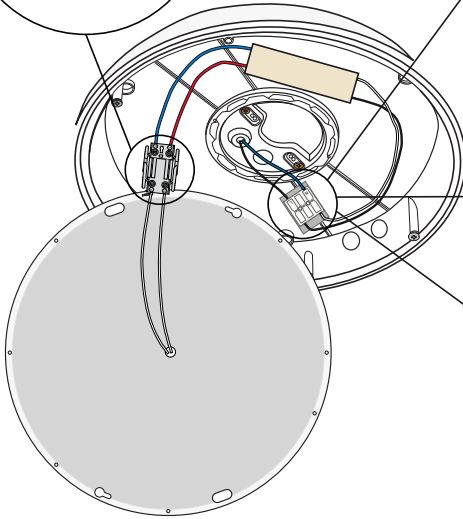

**AVL45**

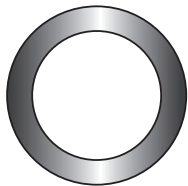

**AVL47**

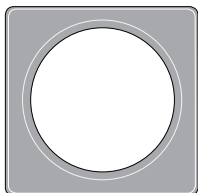

**AVL46**

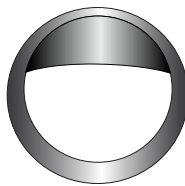

**AVL49**

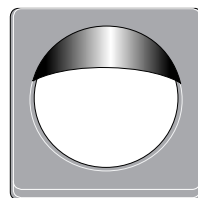

---

**AVL45, AVL47**

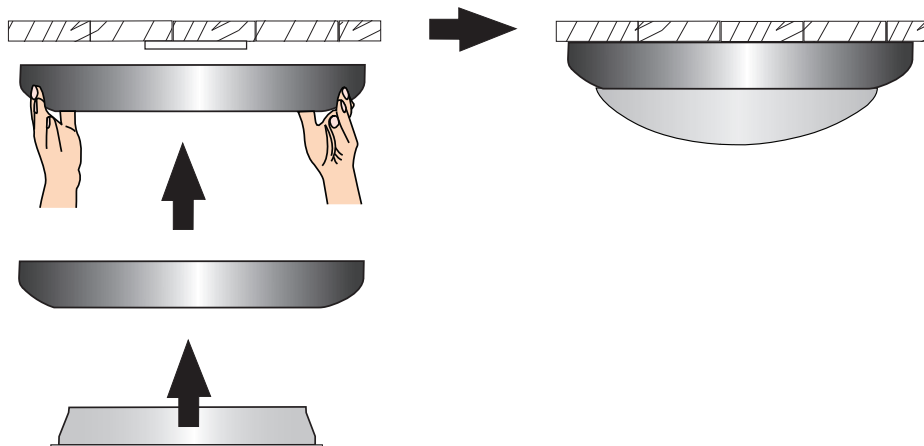





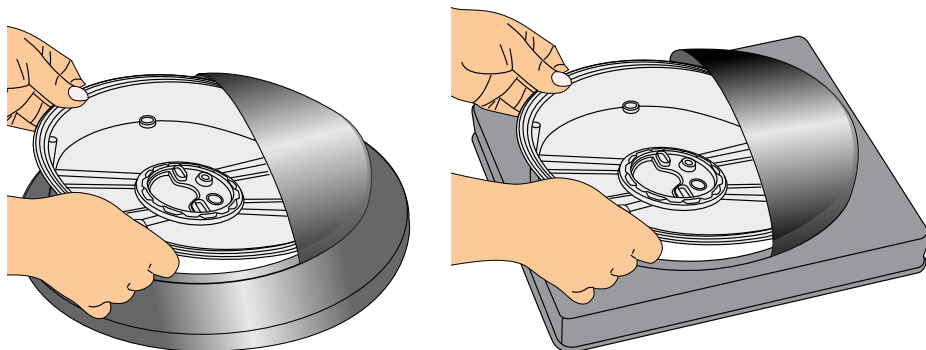

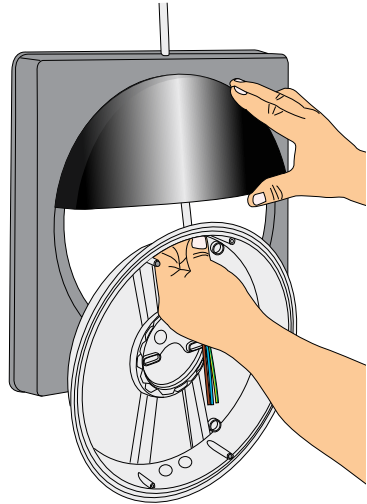
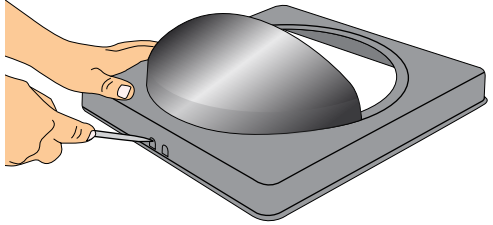
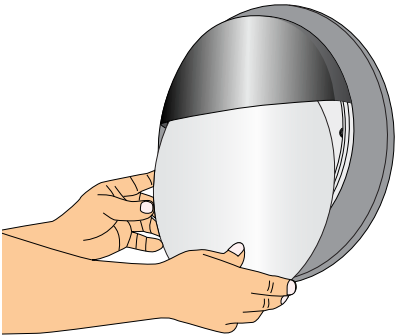
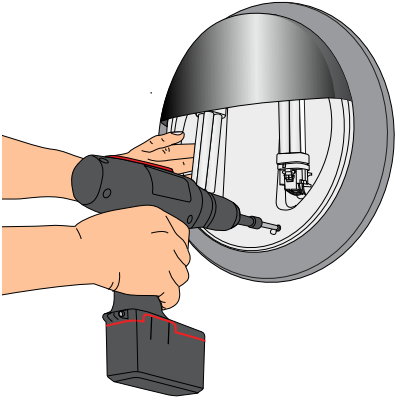
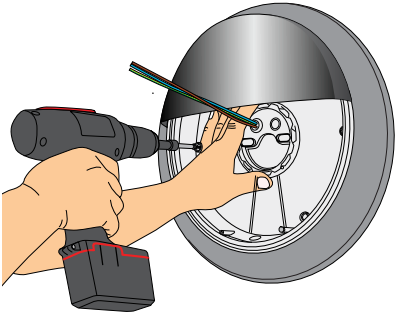





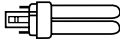

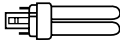

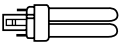

---

**AVL46, AVL49**





AVR320 AVR320.1	1 x 23W TC-DSE/E27 1 x 23W TC-DSE/E27	 62 lm/W		-	0°C...+25°C			
AVR320.013E AVR320.213E	2 x 13W TC-DE/G24-q1	 69 lm/W		A2	-20°C...+25°C	HF		
AVR320.213D	2 x 13W TC-DE/G24-q1			A1	+5°C...+25°C	HFD 1-10V		
AVR320.0134E AVR320.2134E	2 x 13W TC-DE/G24-q1			A2	-20°C...+25°C	PIR		
AVR320.2139E	2 x 13W TC-DE/G24-q1			A2	-20°C...+25°C	RADAR		
AVR320.2135D	2 x 13W TC-DE/G24-q1			A1	+5°C...+25°C	PIR 1-10V		
AVR320.2139D	2 x 13W TC-DE/G24-q1			A1	+5°C...+25°C	RADAR		
AVR320.018E AVR320.218E	2 x 18W TC-DE/G24-q2			 67 lm/W		A2	-20°C...+25°C	HF
AVR320.218/18E	1 x 18W TC-DE/G24-q2 + 1 x 18W TC-DE/G24-q2					A2	-20°C...+25°C	HF
AVR320.018D AVR320.218D	2 x 18W TC-DE/G24-q2	A1	+5°C...+25°C			HFD 1-10V		
AVR320.018DR AVR320.218DR	2 x 18W TC-DE/G24-q2	A1	+5°C...+25°C			HFD 1-10V RELAY		
AVR320.0184E AVR320.2184E	2 x 18W TC-DE/G24-q2	A2	-20°C...+25°C			PIR		
AVR320.0184ER AVR320.2184ER	2 x 18W TC-DE/G24-q2	A2	-20°C...+25°C			PIR RELAY		
AVR320.2189E	2 x 18W TC-DE/G24-q2	 67 lm/W				A2	-20°C...+25°C	RADAR
AVR320.2185D	2 x 18W TC-DE/G24-q2					A1	+5°C...+25°C	PIR 1-10V
AVR320.0186D AVR320.2186D	2 x 18W TC-DE/G24-q2					A1	+5°C...+25°C	PIR
AVR320.2189D	2 x 18W TC-DE/G24-q2					A1	+5°C...+25°C	RADAR
AVR320.026 AVR320.126	1 x 26W TC-D/G24-d3	 69 lm/W		B1	-15°C...+25°C			
AVR320.028E AVR320.128E	1 x 28W TC-DD/GR10q	 80 lm/W		A2	-20°C...+25°C	HF		
AVR320.022CE	1 x 22W T5C/2GX13			A2	-20°C...+25°C	HF		
AVR320.0224CE	1 x 22W T5C/2GX13			A2	-20°C...+25°C	PIR		

AVR320.114L	1 x 14W LED			-	-20°C...+25°C	
AVR320.114DL				-	-20°C...+25°C	1-10V
AVR320.114DDL				-	-20°C...+25°C	DALI
AVR320.114DLR				-	-20°C...+25°C	1-10V RELAY
AVR320.1144L				-	-20°C...+25°C	PIR
AVR320.1149L				-	-20°C...+25°C	RADAR
AVR320.1145DL				-	-20°C...+25°C	PIR 1-10V
AVR320.1146DL				-	-20°C...+25°C	PIR
AVR320.1149DL				-	-20°C...+25°C	RADAR
AVR320.110L	1 x 10W LED			-	-20°C...+25°C	
AVR320.110DL				-	-20°C...+25°C	1-10V
AVR320.110DDL				-	-20°C...+25°C	DALI
AVR320.1104L				-	-20°C...+25°C	PIR
AVR320.1109L				-	-20°C...+25°C	RADAR
AVR320.1105DL				-	-20°C...+25°C	PIR 1-10V
AVR320.1106DL				-	-20°C...+25°C	PIR
AVR320.1109DL				-	-20°C...+25°C	RADAR
.../3K, CCT 3000K						

- FIN** Valaisimen saa asentaa vain riittävän ammattitaidon omaava henkilö. Käytä ainoastaan sytytintyyppiä, valonlähdettä ja tehoa joka valaisimeen on merkitty. Kytke virta pois päältä ennen asennusta tai huoltoa. Tämä asennusohje on säilytettävä ja sen on oltava käytettävissä asennuksessa ja huollossa tulevaisuudessakin.  
Tekninen tuki: +358 200 29009
- SWE** Armaturen får endast installeras av person med tillräcklig yrkesskicklighet. Använd endast tändare, ljuskälla och effekt som är märkta på armaturen. Gör kretsen strömlös före installation eller service. Denna bruksanvisning bör sparas och finnas tillgänglig vid installation eller framtida service.  
Teknisk hjälp: +46 8 556 309 00
- ENG** Only a professional electrician is allowed to do the installation. Use only starters, light sources and rated wattages as marked in the luminaire. Switch off the current before installation or service. This installation instruction must be kept available for future maintenance.
- DEU** Die montage darf nur durch qualifizierte elektriker vorgenommen werden. Nur die anzündertypen und die auf der leuchte angegebene lichtquelle und leistung verwenden. Vor montage und wartung den strom abschalten. Montageanleitung für spätere wartungsarbeiten aufbewahren!
- FRA** La pose doit être faite par un électricien professionnel. Les starters, les types et puissances de lampes utilisés doivent être strictement conformes aux spécifications indiquées à l'intérieur du luminaire. Couper l'alimentation avant l'installation et pendant toute l'intervention. Conserver la notice pour les opérations de maintenance futures.  
Support technique: +334 68 57 20 20
- CZE** Montáž svítidla může provádět pouze pracovník s odrovnými kvalifikací pouziteliných starterů, světelných zdrojů a napětí jsou uvedeny na svítidle. Před instalací nebo opravou svítidla vypněte proud. Tento návod k montáži uchovávejte pro další použití.
- LAV** Gaismekla montāžu var veikt tikai attiecīgas kvalifikācijas strādnieks. Driest izmantot tikai tādus palaišanas iekārtas, gaismas avotu un tā jaudu, kāda ir norādīta uz gaismekla. Pirms montāžas vai remonta ir jāatslēdz strāva. Dota montāžas instrukcija ir jāglabā turpmākajiem montāžas vai apkalpošanas darbiem.
- LIT** Montazo darbus gali atlikti tik darbuotojas, turintis atitinkama kvalifikacija. Naudoti tik ant šviestuvo nurodytus paleidziancius itaisus, šviesos šaltinius ir galingumus. Atjungti itampa prieš montaza ar remonta. Šia instrukcija saugoti ir ja naudotis ateityje, atliekant montazo ir remonto darbus.  
Kontaktai <http://www.ensto.com/lt/kontaktai>.

**POL** Oprawa może być instalowana tylko przez uprawnionego elektryka. Należy używać zapłonników oraz źródeł światła wskazanych w opisie. Przed instalowaniem lub obsługą należy odczekać zasilanie. Instrukcje należy zachować.  
Wsparcie techniczne: +48 58 692 40 00

**EST** Valgustit tohib ühendada vaid nõutava kutseoskusega isik. Kasuta üksnes valgustile märgitud võimsusega starterit ja valgusallikat. Lülita vool välja enne paigaldus- või hooldustööd. Käesolevat paigaldusjuhendit tuleb säilitada ning see peab olema saadaval ka edaspidiste paigaldus- ja hooldustööde ajal.  
Klienditeenindus: +372 6512104  
Tehniline tugi: +372 6512100

**ITA** Il dispositivo di illuminazione va installato da un elettricista professionista. Usare esclusivamente le tipologie di starter, di lampada e il wattaggio indicato sul dispositivo. Spegnere la corrente prima di montare il dispositivo o effettuare riparazioni. Conservare le istruzioni per futuri interventi di manutenzione o eventuali nuove installazioni.  
Supporto tecnico: +39 2 294 030 84

**NOR** Armaturer må kun installeres av en person med faglig dyktighet. Bruk bare forretter, lyskilder og vurdert wattstyrker som er merket i armaturen. Slå av strømmen før installasjon eller service. Denne håndboken skal lagres og være tilgjengelig for fremtidig vedlikehold.  
Teknisk support: +47 22 90 44 00

**UKR** Світильник може бути встановлений тільки людиною, яка має достатню професійну валіфікацію. Відключити напругу до початку монтажу чи обслуговування. Цю інструкцію зберігати та використовувати при подальшому обслуговуванні. Застосовувати запальючий пристрій та лампу тільки такі, які вказані на світильнику.

## **ВІДОМОСТІ ПРО СЕРТИФІКАЦІЮ**

Продукція сертифікована і відповідає вимогам нормативних документів.

### **Импортер:**

ПрАТ "Енсто Україна"  
вул. Полярна, 12а  
Київ 04655  
Україна  
Тел. +38 044 581 37 92

[ensto.ukraine@ensto.com](mailto:ensto.ukraine@ensto.com)

RUS

Светильник может устанавливаться только человеком, обладающий достаточной профессиональной квалификацией. Отключить ток до начала монтажа или обслуживания. Эту инструкцию сохранять и в дальнейшем применять при монтаже и обслуживании. Применять только указанное на светильнике зажигающее устройство и лампу, указанной мощности.

#### **СВЕДЕНИЯ О СЕРТИФИКАЦИИ**

Товар сертифицирован и соответствует требованиям нормативных документов.

#### **ИНФОРМАЦИЯ О ПРОИЗВОДИТЕЛЕ И ИМПОРТЕРЕ**

##### **Заводы-изготовители:**

"Ensto Finland Oy" ("Энсто Финланд Ой")

Ensio Miettisen katu, P.O.BOX 77 (Энсио Миеттисен ул., п/я 77)

06101 Porvoo, Finland (06101 Порвоо, Финляндия)

"Ensto Ensek AS" (Эстония)

Paldiski mnt 35/4A

76606 Keila, Estonia

##### **Импортер:**

ООО "Энсто Рус"

105062 Москва

Подсосенский переулок, д.20, стр.1

Тел. +7 495 258 52 70

Факс. +7 495 258 52 69

ООО "Энсто Рус"

196084, Россия, Санкт-Петербург

Ул.Воздухоплавательная, д.19

тел. (812) 336 99 17

факс (812) 336 99 62

[www.ensto.ru](http://www.ensto.ru)



*Saves Your Energy*

Ensto Lighting Oy  
Hepolammentie 25  
FIN-08680, Finland  
Tel. +358 19 328 51  
Customer service +358 19 328 51  
Fax. +358 382 856  
ensto@ensto.com  
**www.ensto.com**