

Tuotetiedot

Tuotekoodi	VC02-0152	Sähkönumero	1914400	EAN-koodi	6430051863073
Tuotenimi	OT-yleiskaapelikenkä 2xAl/Cu 35-240mm ² 2xM10	ETIM-luokka	EC000897		
Johtimet	2xAl/Cu 35-240 mm ²				

Tekniset tiedot

Nimellisvirta (IEC)	Cu	850	A
	Al	380	A
Nimellisjännite (IEC)		690	V
		-	
		-	
		-	
Napaluku		1	kpl
Max. Johdinkoko		240	mm ²
Kiristysmomentti			
	35-120 mm ²	26	Nm
	150-240 mm ²	40	Nm
		-	
		-	
		-	
Käyttölämpötila		-20..+80	°C
Paino		229	g
		-	

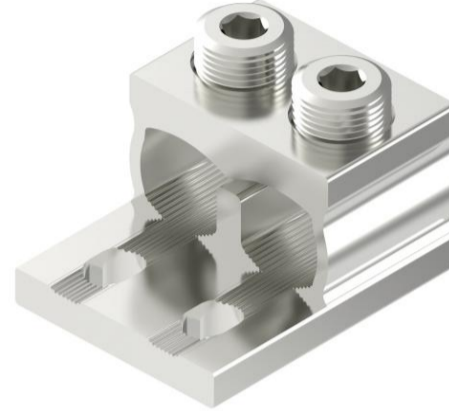

Standardit	EN 61238-1; EN60947-7-1
Väri / Materiaali	Tinapinnoitettu alumiini
Kiinnitys / Kytkenä	Ruuvi 2xM20

Kuvaus

Ounevan OT-yleisliittimet ovat tarkoitettu Al- ja Cu-johdinten laitteistokytkentöihin. Liittimiä käytetään sähkökojeissa ja kojeistoissa. OT-liittimet valmistetaan tinapinnoitetusta alumiinista. Liittimet valmistetaan Suomessa.

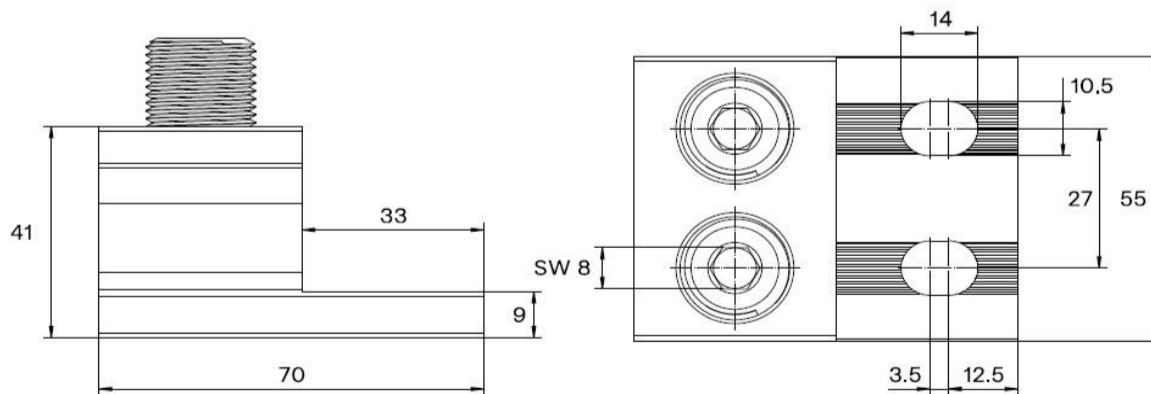
Mittakuva

Pakkaus

Pakkausmuoto	Laatikko	Kpl / Pakkaus	10	Paino [kg]	2,39
Pituus [mm]	210	Leveys [mm]	160	Korkeus [mm]	105

Ouneva Oy

Teollisuustie 21
FI-82730 Tuupovaara
Finland

www.ounevagroup.fi

www.ounevaproducts.fi

Product data

Product code	VC02-0152	STK-code	1914400	EAN-code	6430051863073
Product name	OT Universal connector 2xAl/Cu 35-240mm ² 2xM10			ETIM class	EC000897
Wires	2xAl/Cu 35-240 mm ²				

Technical data

Nominal current (IEC)	Cu	850	A
	Al	380	A
Nominal voltage (IEC)		690	V
		-	
		-	
		-	
Number of poles		1	pcs
Max. Cross section		240	mm ²
Tightening torque			
	35-120 mm ²	26	Nm
	150-240 mm ²	40	Nm
		-	
		-	
		-	
Operating temperature		-20..+80	°C
Weight		229	g
		-	



Standards	EN 61238-1; EN60947-7-1
Color / Material	Tin plated aluminium
Mounting / Connection	Screw 2xM20

Description

Ouneva OT-connectors are a universal terminal series for connecting Al- and Cu-conductors to equipment. OT-connectors are used in equipment or as a transfer terminal between copper and aluminium. Connectors are made of tin plated aluminium. The connectors are manufactured in Finland.

Drawing

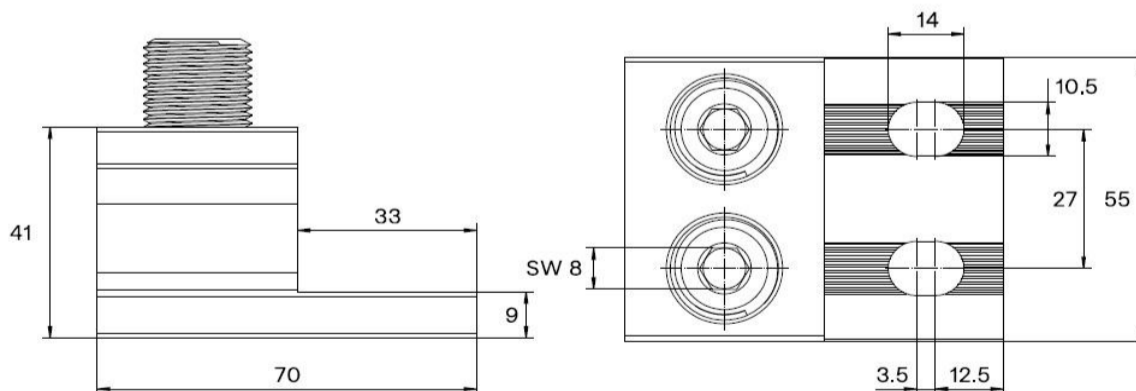

Package

Package	Box	Pcs / Package	10	Weight [kg]	2,39
Length [mm]	210	Width [mm]	160	Height [mm]	105

Ouneva Oy

Teollisuustie 21
FI-82730 Tuupovaara
Finland

www.ounevagroup.fi

www.ounevaproducts.fi