









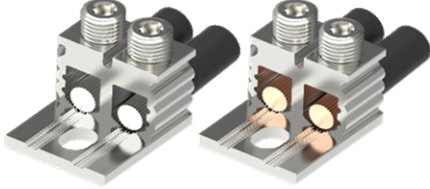
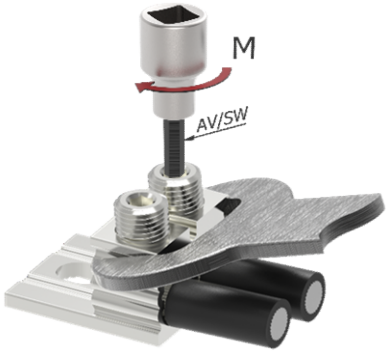

Tuotetiedot							
Tuotekoodi	Tuotenimi	I _n Al	I _n Cu	U _n	USA spesifiset		
					I _{max} Al	I _{max} Cu	U _{max}
VC02-0136	OT-yleiskaapelikenkä 2xAl/Cu 6-95mm ²	220 A	490 A	690 V	-	-	-

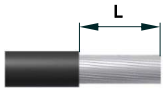

Yleistä	Johtimien asennus
<p>OT-yleisliittimet ovat tarkoitettu alumiini- ja kuparikaapeleiden liittämiseen.</p> <ul style="list-style-type: none"> - Sektorikaapeli on muokattava pyöreäksi ennen asennusta. Esimuokkaus siirtoleukapihdeillä ennen eristyksen poistamista tai pyörästysleuoilla eristyksen poistamisen jälkeen. - Poista eristys kaapelista. Ks. kuorintapitus L taulukosta alapuolella. - Poista mahdollinen oksidikerros messinki- tai teräsharjalla. - Liitin on esirasvattu liitosrasvalla.  	 <p>Tue liitin kiristyskäsiksi.</p> <p>Kiristä liitinruuvit alla mainittuun kiristysmomenttiin M.</p> <p>Varmista liitinruuvien kireydet ensimmäisten momenttien kiristysten jälkeen. Tee tarvittaessa jälkikiristys.</p> <p>Asennettaviin johtimiin ei saa kohdistua vetojännitystä.</p> 

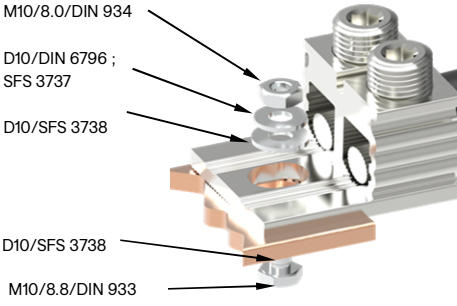



Kytkeä			
Ruuvien koko	Ruuvi	M14	Kiristysmomentti M
	AV	6	6-25 mm ² 12 Nm
			35-95 mm ² 22 Nm
			Kuorintapitus L 21±1 mm
			
			Johtimet 2xAl/Cu 6-95 mm²
Kuparijohtimet	Alumiinijohtimet	Sallitut IEC 60228 -johdintyytit	
Max. 3 X CU / Liitinaukko	1 X AL / Liitinaukko	Class 5 & 6 (hienosäikeinen) Suositellaan johdinpääholkkia	
		Class 1 & 2 (yksi- ja muutamalankainen)	
≤ 95 mm ² yhteensä	Liitosrasva: esim. Penetrox		
		Muokkaa pyöreäksi	

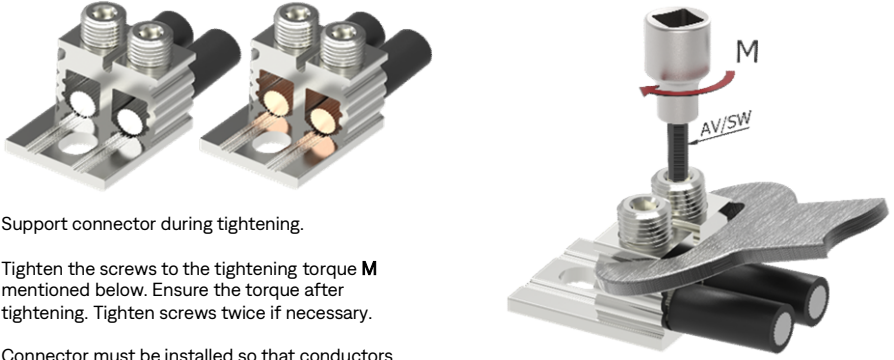

Asennus virtakiskoon	Huomi!
<ul style="list-style-type: none"> - Kun kytket liittimen virtakiskoon, varmistu että liitospinnat ovat puhtaat ja reikien reunoilla ei ole purseita. - Käytä kuvan mukaisia tai vastaavia kiinnitystarvikkeita. - Suositus kiritysmomentti 30-44 Nm <p>Huom! Ruuvien pituus riippuu virtakiskon paksuudesta.</p>  <p>M10/8.0/DIN 934 D10/DIN 6796 ; SFS 3737 D10/SFS 3738 D10/SFS 3738 M10/8.8/DIN 933</p>	 <p>Liittäessä alumiinikiskoon on kiskon pinta harjattava teräsharjalla ja välittömästi käsiteltävä liitosrasvalla. Kosteissa tiloissa suojarasvan käyttö on suositeltavaa (esim. Penetrox). Kiskon puolella on käytettävä paineentasauslaatan lisäksi kartiomaista puristuslaattaa (esim. DIN 6796).</p>

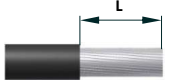
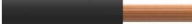
Johdintaulukko, poikkipinta-ala ja johtojen määrä / kytkentätila (Al-johtimien määrä suluisissa)															
1,5 mm ²	2,5 mm ²	6 mm ²	10 mm ²	16 mm ²	25 mm ²	35 mm ²	50 mm ²	Taulukossa olevat johtimien luvut tarkoittavat vain tehdasmaisesti asennettuja liittimiä.							
-	-	3 (1)	3 (1)	3 (1)	3 (1)	2 (1)	1 (1)								
								70 mm ²	95 mm ²	120 mm ²	150 mm ²	185 mm ²	240 mm ²	300 mm ²	400 mm ²
								1 (1)	1 (1)	-	-	-	-	-	-

Product data							
Product code	Product name	I _n Al	I _n Cu	U _n	US specific		
					I _{max} Al	I _{max} Cu	U _{max}
VC02-0136	OT Universal connector 2xAl/Cu 6-95mm ²	220 A	490 A	690 V	-	-	-

General	Conductor installation
<p>OT-Connectors are suitable for Aluminium- and Copper conductors.</p> <ul style="list-style-type: none"> - Segmental conductors have to be rounded before mounting. Pre-shape the sector conductor with transfer jaw pliers before removing the insulation or with rounding jaws after removing the insulation. - For stripping cable, see stripping length L (table below) - Remove any layer of oxide by brass or steel brush.  	 <p>Support connector during tightening.</p> <p>Tighten the screws to the tightening torque M mentioned below. Ensure the torque after tightening. Tighten screws twice if necessary.</p> <p>Connector must be installed so that conductors are relieved from strain.</p>

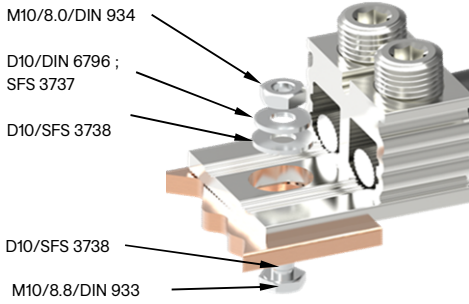
Connection							
	Screw	Screw	M14	Tightening torque M	6-25 mm ²	12 Nm	Stripping length L 21±1 mm 
		SW	6		35-95 mm ²	22 Nm	
Conductor range				2xAl/Cu 6-95 mm²			
Copper conductors	Aluminium conductors	Supported IEC 60228 -conductors				Sector shaped cable	
Max. 3 X CU / Conductor contact space  ≤ 95 mm ² total	1 X AL / Conductor contact space  Anti-corrosion paste: e.g. Penetrox	 Class 5 & 6 (fine stranded) Using ferrule is recommended Class 1 & 2 (solid and stranded)	 Pre-round the cable				

Mounting to busbar	Attention
<ul style="list-style-type: none"> - Be sure that there are no burrs around the hole. - Length of the screw depends on the busbar thickness. - Use standard screws, nuts and washers. (Plated with Zn) - Recommended torque for M10 is 30-44 Nm. 	 <p>When connecting to an aluminium rail, the surface of the rail must be brushed with a wire brush and immediately treated with connecting grease. In damp areas, the use of protective grease is recommended (eg. Penetrox). On the rail side, in addition to the pressure relief plate, a conical press plate (eg. DIN 6796) must be used.</p>

Cross section and max. number of Cu- conductors / contact space (Al- conductors in parenthesis)									
1,5 mm ²	2,5 mm ²	6 mm ²	10 mm ²	16 mm ²	25 mm ²	35 mm ²	50 mm ²	The specified max. amount of conductors refers only to industrially installed terminals.	
-	-	3 (1)	3 (1)	3 (1)	3 (1)	2 (1)	1 (1)		
		70 mm ²	95 mm ²	120 mm ²	150 mm ²	185 mm ²	240 mm ²	300 mm ²	400 mm ²
		1 (1)	1 (1)	-	-	-	-	-	-