



ENVIRONMENTAL PRODUCT DECLARATION

EPD OF MULTIPLE PRODUCTS, BASED ON A REPRESENTATIVE PRODUCT

Programme: **The International EPD® System, www.environdec.com**

Programme operator: **EPD International AB**

EPD registration number: **EPD-IES-0017167**

Publication date: **2024-11-25**

Valid until: **2029-11-25**

In accordance with
ISO 14025:2006 and
EN 15804:2012+A2:2019/AC:2021 for:
**PRESSFITTING SYSTEM
MADE IN STAINLESS STEEL**

from
Raccorderie Metalliche SpA



THE INTERNATIONAL EPD® SYSTEM



inoxPRES®



RACCORDERIE METALLICHE

General Information

Programme information

Programme The International EPD[®] System

Address EPD International AB
Box 210 60
SE-100 31 Stockholm
Sweden

Website www.environdec.com
e-mail info@environdec.com

Accountabilities for PCR, LCA and independent, third-party verification

Product Category Rules (PCR)

CEN standard EN 15804 serves as the Core Product Category Rules (PCR)

Product Category Rules (PCR): PCR 2019:14 Construction products (EN 15804+A2) (1.3.4)

PCR review was conducted by: The Technical Committee of the International EPD[®] System. Review chair: No chair appointed-

Contact via the Secretariat www.environdec.com/contact

Life Cycle Assessment (LCA)

LCA accountability: MADE HSE S.r.l.

Third-party verification

Independent third-party verification of the declaration and data, according to ISO 14025:2006, via:

EPD verification by accredited certification body

Third-party verification: Bureau Veritas Italia S.p.A. is an approved certification body accountable for the third-party verification

The certification body is accredited by: Accredia – accreditation number 0009VV

Procedure for follow-up of data during EPD validity involves third party verifier:

Yes No

The EPD owner has the sole ownership, liability, and responsibility for the EPD.

EPDs within the same product category but registered in different EPD programmes, or not compliant with EN 15804, may not be comparable. For two EPDs to be comparable, they must be based on the same PCR (including the same version number) or be based on fully-aligned PCRs or versions of PCRs; cover products with identical functions, technical performances and use (e.g. identical declared/functional units); have equivalent system boundaries and descriptions of data; apply equivalent data quality requirements, methods of data collection, and allocation methods; apply identical cut-off rules and impact assessment methods (including the same version of characterisation factors); have equivalent content declarations; and be valid at the time of comparison. For further information about comparability, see EN 15804 and ISO 14025.



Company information

Owner of the EPD:

Raccorderie Metalliche S.p.A.
Sabbionetana Street, 59 - 46010
Campitello - Mantova (MN)

Contact:

To obtain more information about this product declaration and / or its configurations, the following references are available:

Mail: info@racmet.com

Phone: 0376 96001

Description of the organisation:

Since 1970, Raccorderie Metalliche is a leading manufacturer in the European civil & industrial plumbing sector landscape. Since 2014 we are present in the shipbuilding sector and the only one in the market being in a position to offer pressfitting systems, steel wastewater systems, welding fittings, threaded fittings and fastening systems, at the same time.

Every day, more than 400 employees are committed to fulfil Raccorderie Metalliche's mission.

«We constantly offer innovative solutions in terms of both product and process and take the use of fitting systems into particular consideration; these solutions allow fitters to work rapidly, safely and suitably.»

Raccorderie Metalliche has two production plants in Italy, extending over an area of more than 93.000 sq. m, as well as 3 branch offices in foreign Countries (Germany, France and Spain) ensuring the distribution of our products in more than 60 countries of the world.

Product-related or management system-related certifications:

- Quality management system compliant with the requirements of the standard ISO 9001:2015 (certificate n° CERT-00317-94-AQ-MIL-SINCERT issued by DNV Business Assurance Italy S.r.l.);
- Environmental management system compliant with the requirements of the standard ISO 14001:2015 (certificate n° 90476-2010-AE-ITA-SINCERT issued by DNV Business Assurance Italy S.r.l.);
- Health and safety management system compliant with the requirements of the standard ISO 45001:2018 (certificate n° 10000457222-MSC-ACCREDIA-ITA issued by DNV Business Assurance Italy S.r.l.);
- Energy Management System compliant with the requirements of the standard ISO 50001:2018 (certificate n° C602883 issued by DNV Business Assurance Italy S.r.l.).

Name and location of production site(s):

- Strada Sabbionetana, 59 - 46010 Campitello di Marcaria (MN);
- Str. Montanara Sud, 126, 46010 - Pilastro di Marcaria (MN).

Product information

Product name: Pressfitting system made in stainless steel

Product identification: inoxPRES

Product description: inoxPRES is the Pressfitting system by Raccorderie Metalliche perfectly matching stainless steel features with the benefits of the pressfitting system. Fittings in 316L stainless steel can be fitted to a wide range of pipes, from 15 to 168 mm diameters, in 316L, 304L and 444 steel. Joints are fitted with an “M-shaped” profile toroidal chamber, optimised thanks to Raccorderie Metalliche experience, where a patented profiled O-Ring is fitted directly at the end of production. The wide range of **inoxPRES** pipes and pipe fittings are approved by many international certification institutions. Besides the 30 certifications obtained, some apply to the potable water, compressed air, natural gas, service and fire protection water transportation.

- A reliable and rapid solution with the best possible quality-price ratio;
- A wide range of fittings and pipes Ø 15 - 168 mm in 316L, 304L and 444 steel;
- A wide range of reliable the Raccorderie Metalliche patented O-Ring fitting;
- More than 14,000 square meters warehouse;
- A wide range of approved pressing machines to be used for the inoxPres system;
- A solution with the best quality-price ratio in terms of products and services;
- 100% Italian know-how.

Products and services are developed to solve at best any installation problem and issue, aiming at quality, safety and speed. Stainless steel is the best solution where water purity and hygiene matter. From potable water plants, water adduction in industrial processes up to clinics where periodically a chemical and thermal disinfection is enforced. **inoxPRES** by Raccorderie Metalliche offers the best possible quality of materials and safety guarantee. “Visible” **inoxPRES** installations provide for a higher degree of hygiene and clearing. O-Rings can be used between -20 and +120°C, maximum pressure 16bar providing for quality and safety as well.

The products represent by this declaration are:

- Pipe for gas;
- 15°elbow FF;
- 15°elbow MF;
- 30° elbow FF;
- 30° elbow MF;
- 45° elbow FF;
- 45° elbow MF;
- 60° elbow FF;
- 60° elbow MF;
- 90° elbow FF;
- 90° elbow MF;
- Equal tee;
- Branch tee female;
- Reducing tee;
- Coupling;
- Slip coupling;
- Stop end;
- Half welding coupling;
- Male adapter;
- Reducer;
- Pipe bridge;
- Pipe for compressed air;
- 90° elbow tube MM;
- Adaptor flange;
- Collar for loose flange;
- Expansion compensator.

The results refer to the company's representative product, i.e. "inoxpres elbow 90° FF Ø 28": it's the product most marketed by the company and which best represents the pressfitting process.

UN CPC code: 4128 - Tubes, pipes and hollow profiles of steel.

Geographical scope: Europe

LCA information

Functional unit / declared unit: 1 kg of pressfitting system

Reference service life: It isn't possible to quantify the exact useful life as much also depends on their future use. However, it is specified that upon reaching the end of the product can be recycled and reused again to generate other raw materials.

Time representativeness: The data used is representative of the year 2023

Database(s) and LCA software used: Ecoinvent database v.3.10 – March 2024, Software SimaPro rel. 9.6.0.0

Description of system boundaries:

The study is from Cradle to gate with options, modules C1–C4 and module D (A1–A3 + A5 + C + D).

Modules A1–A3 include material procurement processes (raw and auxiliary materials) as well as manufacturing processes.

Module A5 is considered partially and includes the the biogenic CO₂ emissions deriving from the packaging material.

Modules C1–C4 consider the uninstallation, transport, sorting and disposal of components deriving from the end-of-life operations. These operations are not directly controllable by the company: in this regard, literature data relating to the construction sector are therefore used. It is considered:

- an average consumption of diesel equivalent to 0.046 MJ for each kilogram of demolished material;
- an average distance of 80 km to transport the material to the recovery center;
- an average consumption of electricity of 0.028 kW for each kilogram of waste subjected to sorting operations at the delivery center.

Module D considers steel intended for recycling resulting from the demolition process of the product after its use and after being delivered to the waste treatment center.

Method use

The methodology chosen to evaluate the potential environmental impacts used in this study is the method “EN15804 + A2 (adapted for SimaPro substances) EF 3.1 normalization and weighting set

– v.1.01” relating to construction products. For the calculation of the environmental impact relating to the GWP–GHG indicator, the method “IPPC 2021 GWP 100a – v.1.03” is used.

Allocation rules

Data for which it was not possible to refer only to the single product (e.g. some auxiliary materials, some energy consumption), were allocated on a mass basis.

Cut-off rules and exclusions

The criterion chosen for the initial inclusion of inputs and outputs is based on the definition of a cut-off level of 1%, in terms of environmental relevance. This means that a process can be ignored if it is responsible for less than 1% of the total impact.

Also excluded from the study are:

- Staff mobility between home and work;
- Indirect activities (e.g. research and development activities);
- Staff business travels;
- Water discharges;
- Maintenance.

Percentage variation of each environmental impact indicator, aggregate over all included modules (from A to C) between the value minimum and maximum of the included products

| Impact category | AP | EP-marine | EP-fresh-water | EP-terrestrial | ODP | POCP | ADP-fossil | ADP-minerals&metals | WDP |
|-----------------|-----|-----------|----------------|----------------|-----|------|------------|---------------------|-----|
| Variations [%] | 20% | 29% | 18% | 24% | 0% | 22% | 24% | 0% | 19% |

The variations are attributable to any peculiarities of the raw material as well as process requirements for the production of some products.



Description of the Production Cycle of pressfitting system in stainless steel

The manufacturing flow for Inoxpres fittings is divided in steps, which gradually allow a press fitting to be shaped, typically starting from a pipe. The manufacturing process is certified by the main international bodies, in the civil, industrial, and naval fields. The production equipment is designed internally by RM technical & robotics department and fabricated internally utilizing the latest generation of machine tools.

Manufacturing phases:

- 1. PIPE CUTTING.** Using laser cutting machines, stainless steel pipes and rods are cut to make the specific pieces by article code.
- 2. BENDING.** Subsequently, if the fitting to be construct is a curve, the pieces are bent through automatic bending machines; each piece of pipe are bent according to the angle required as per the approved drawing.
- 3. COLD DEFORMATION.** To shape the press fitting profile are utilised different methods of cold elongation of the pipes. This is the most critical step as the proper functioning of the fitting depends on it.
- 4. WELDING.** For some types of fittings, it is necessary to have an additional manufacturing process to weld the body of the fittings to a specific part, previously prepared. For instance, to produce equal Tees, or reducing Tees, a hole on the main body must be drilled, then welded together with a second piece to create the Tee-shape.
The welding is carried out through an automated TIG welding process with filler material. This process is certified by the leading international bodies and is subject to periodic auditing. All welded fittings are subjected to testing, to identify any porosity, avoid leakages and guarantee the highest possible quality.
- 5. ANNEALING.** At the end of mechanical processing, stainless steel fittings must be heat treated, namely annealing method, through a solubilization process, inducing the relaxation of internal tensions, thus improving the machinability on site of the fittings.
- 6. O-RING INSTALLATION.** O-rings are assembled utilizing automatic lines, composed by a combination of machine tools and robots, where the required O-ring is inserted into the fitting, according to the application for which the fittings are intended. In this phase fittings are also marked according to the product specifications.
- 7. PACKAGING.** . Fittings are packed in bags then in carton boxes according to the specific internal requirements (each type of items has its own minimum bags and box standard quantity). Product information, certifications and technical data are available on the packaging to ensure batch traceability.



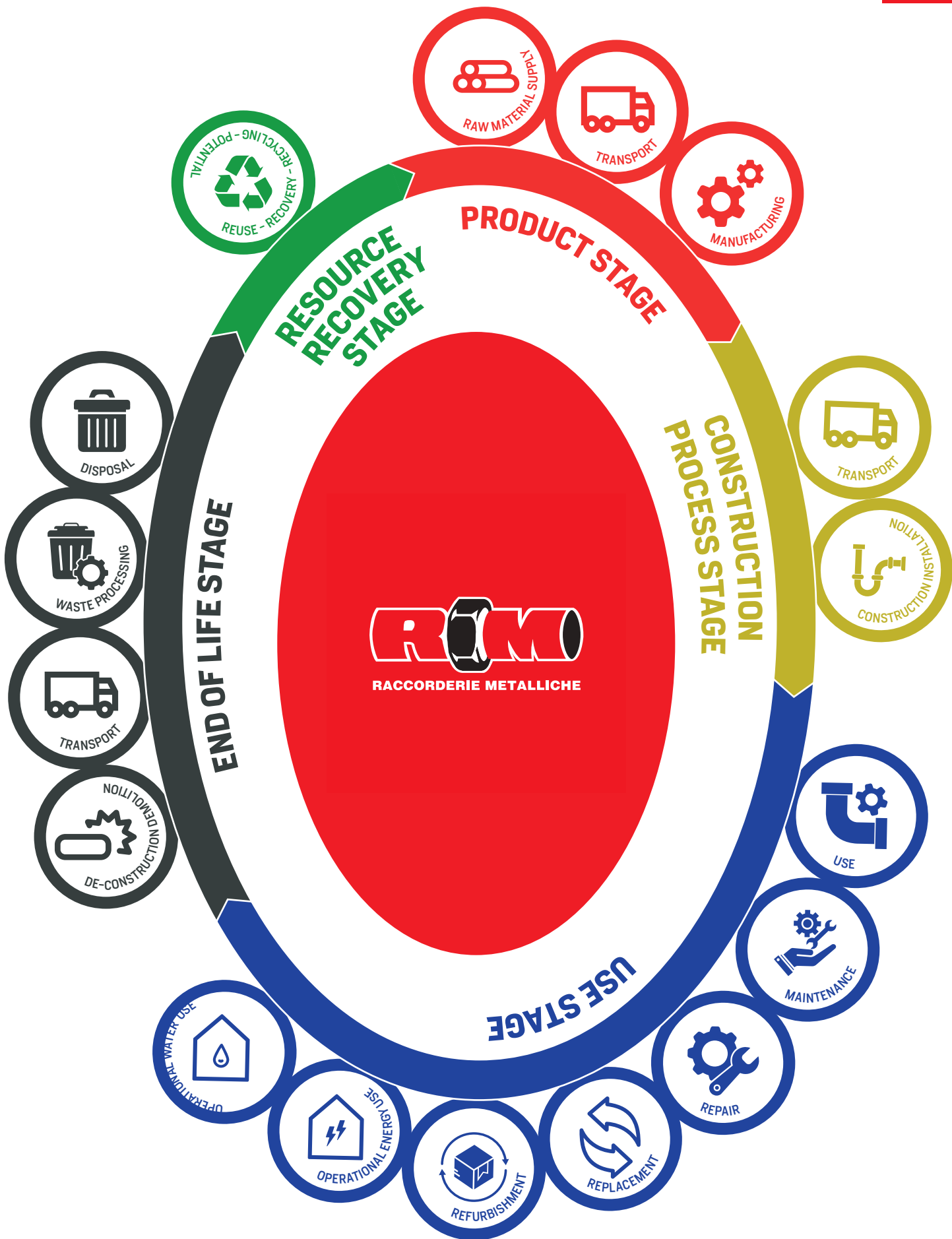

PRODUCTION CYCLE



1° PHASE

Pipe Cutting

using laser cutting machines, stainless steel pipes and rods are cut to make the specific pieces by article code.

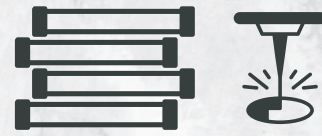

2° PHASE

Bending

if the fitting to be construct is a curve, the pieces are bent through automatic bending machines; each piece of pipe are bent according to the angle required as per the approved drawing.



3° PHASE

Deformation

To shape the press fitting profile are utilised different methods of cold elongation of the pipes. This is the most critical step as the proper functioning of the fitting depends on it.



4° PHASE

Welding

for some types of fittings, it is necessary to have an additional manufacturing process to weld the body of the fittings to a specific part, previously prepared.

The welding is carried out through an automated TIG welding process with filler material. This process is certified by the leading international bodies and is subject to periodic auditing.

All welded fittings are subjected to testing, to identify any porosity, avoid leakages and guarantee the highest possible quality.



5° PHASE

Annealing

At the end of mechanical processing, stainless steel fittings must be heat treated, namely annealing method, through a solubilization process, inducing the relaxation of internal tensions, thus improving the machinability on site of the fittings.



6° PHASE

O-ring Installation

O-rings are assembled utilizing automatic lines, composed by a combination of machine tools and robots, where the required O-ring is inserted into the fitting, according to the application for which the fittings are intended. In this phase fittings are also marked according to the product specifications.



7° FASE

Packaging

Fittings are packed in bags then in carton boxes according to the specific internal requirements (each type of items has its own minimum bags and box standard quantity).

Product information, certifications and technical data are available on the packaging to ensure batch traceability.



Modules declared, geographical scope, share of specific data (in GWP-GHG results) and data variation (in GWP-GHG results):

| | Product stage | | | Construction process stage | | Use stage | | | | | End of life stage | | | | Resource recovery stage | | |
|----------------------|---------------------|-----------|---------------|----------------------------|---------------------------|-----------|-------------|--------|-------------|---------------|------------------------|-----------------------|----------------------------|-----------|-------------------------|----------|------------------------------------|
| | Raw material supply | Transport | Manufacturing | Transport | Construction installation | Use | Maintenance | Repair | Replacement | Refurbishment | Operational energy use | Operational water use | De-construction demolition | Transport | Waste processing | Disposal | Reuse-Recovery-Recycling-potential |
| Module | A1 | A2 | A3 | A4 | A5 | B1 | B2 | B3 | B4 | B5 | B6 | B7 | C1 | C2 | C3 | C4 | D |
| Modules declared | X | X | X | ND | X | ND | ND | ND | ND | ND | ND | ND | X | X | X | X | X |
| Geography | GLO | GLO | IT | - | - | - | - | - | - | - | - | - | EU | EU | EU | EU | EU |
| Specific data | > 80% | | | - | - | - | - | - | - | - | - | - | - | - | - | - | - |
| Variations - product | -3.4% ÷ +17.0%* | | | - | - | - | - | - | - | - | - | - | - | - | - | - | - |
| Variation - site | < 10% | | | - | - | - | - | - | - | - | - | - | - | - | - | - | - |

X = Module considered / ND = Module not declared / GLO = Global / IT = Italy / EU = Europe

* Range of the GWP-GHG indicator for modules A1-A3. The range is reported from the configuration with the lowest impact and the one with the highest impact respect the representative product.



Content information

| PRODUCT COMPONENTS | WEIGHT, KG | POST-CONSUMER MATERIAL, WEIGHT-% | BIOGENIC MATERIAL, WEIGHT-% AND KG C/KG |
|----------------------------|-------------------|---|--|
| Stainless steel | 0.995 | 67.4 | - |
| EPDM (O-Ring) | 0.005 | - | - |
| TOTAL | 1 | - | - |
| PACKAGING MATERIALS | WEIGHT, KG | WEIGHT-% (VERSUS THE PRODUCT) | WEIGHT BIOGENIC CARBON, KG C/KG |
| Polyethylene bag | 0,003 | 0,3% | - |
| Cardboard | 0,001 | 0,1% | 0,000837 |
| Wood | 0,082 | 8,2% | 0,145 |
| TOTAL | 0.86 | - | - |

The product doesn't contain SVHC Substances of Very High Concern covered by ECHA's Candidate List in concentrations greater than 0.1% by mass.

Content information

Electricity information

The electricity used in the manufacturing process of module A3 accounts less than 30% of the GWP-GHG results of modules A1-A3 and the impact of electricity use in the manufactory phases is 0.550 kg CO₂ eq/kWh (value resulting from the modelling of the Italian Residual Electricity Mix).

Results of the environmental performance indicators

The following tables show the values of the environmental impact indicators for the declared unit, i.e. 1 kg of pressfitting system.

We do not recommend using the results of modules A1-A3 without considering the results obtained from modules C.

The results of the estimated impact are only relative statements, which do not indicate the end point of the various impact categories, the exceedance of threshold values, safety margins and/or risks.

The values in the following tables refer to the company's representative product, i.e. "inoxPRES 90° FF elbow Ø 28".

To obtain the indicators for a specific piece, simply multiply the chosen indicator by the weight of the piece shown in the table in the "Other Information" paragraph.

Mandatory impact category indicators according to EN 15804

| RESULTS PER FUNCTIONAL OR DECLARED UNIT | | | | | | | | | | | | | | | | |
|---|---|-----------|----|----------|----|----|----|----|----|----|----|----------|----------|----------|----------|-----------|
| Indicator | Unit | A1-A3 | A4 | A5 | B1 | B2 | B3 | B4 | B5 | B6 | B7 | C1 | C2 | C3 | C4 | D |
| GWP-fossil | kgCO ₂ eq. | 4,96E+00 | ND | 0,00E+00 | ND | ND | ND | ND | ND | ND | ND | 4,61E-03 | 1,55E-02 | 1,83E-02 | 6,25E-04 | -4,25E+00 |
| GWP-bio-genic | kgCO ₂ eq. | -2,77E-02 | ND | 1,46E-01 | ND | ND | ND | ND | ND | ND | ND | 5,04E-07 | 1,06E-05 | 2,39E-04 | 8,62E-08 | -3,64E-02 |
| GWP-luluc | kgCO ₂ eq. | 2,61E-03 | ND | 0,00E+00 | ND | ND | ND | ND | ND | ND | ND | 4,00E-07 | 5,06E-06 | 1,43E-06 | 3,22E-07 | -3,25E-03 |
| GWP-total | kgCO ₂ eq. | 4,94E+00 | ND | 1,46E-01 | ND | ND | ND | ND | ND | ND | ND | 4,61E-03 | 1,55E-02 | 1,85E-02 | 6,26E-04 | -4,29E+00 |
| ODP | kgCFC11eq. | 7,54E-06 | ND | 0,00E+00 | ND | ND | ND | ND | ND | ND | ND | 7,05E-11 | 3,08E-10 | 3,83E-10 | 1,81E-11 | -2,92E-08 |
| AP | molH ⁺ eq. | 2,35E-02 | ND | 0,00E+00 | ND | ND | ND | ND | ND | ND | ND | 4,16E-05 | 4,84E-05 | 4,76E-05 | 4,43E-06 | -2,36E-02 |
| EP-fresh-water | kgPeq. | 1,49E-03 | ND | 0,00E+00 | ND | ND | ND | ND | ND | ND | ND | 1,35E-07 | 1,03E-06 | 2,32E-06 | 5,19E-08 | -1,36E-03 |
| EP-marine | kgNeq. | 4,27E-03 | ND | 0,00E+00 | ND | ND | ND | ND | ND | ND | ND | 1,93E-05 | 1,63E-05 | 9,49E-06 | 1,69E-06 | -4,27E-03 |
| EP-terrestrial | molNeq. | 4,54E-02 | ND | 0,00E+00 | ND | ND | ND | ND | ND | ND | ND | 2,11E-04 | 1,78E-04 | 1,00E-04 | 1,84E-05 | -4,55E-02 |
| POCP | kgNMVOCeq. | 1,62E-02 | ND | 0,00E+00 | ND | ND | ND | ND | ND | ND | ND | 6,30E-05 | 7,59E-05 | 4,59E-05 | 6,60E-06 | -1,42E-02 |
| ADP-minerals&metals* | kgSbeq. | 9,33E-04 | ND | 0,00E+00 | ND | ND | ND | ND | ND | ND | ND | 1,64E-09 | 4,95E-08 | 7,65E-09 | 9,77E-10 | -1,05E-04 |
| ADP-fossil* | MJ | 5,80E+01 | ND | 0,00E+00 | ND | ND | ND | ND | ND | ND | ND | 6,03E-02 | 2,17E-01 | 2,71E-01 | 1,53E-02 | -4,67E+01 |
| WDP* | m ₃ | 1,36E+00 | ND | 0,00E+00 | ND | ND | ND | ND | ND | ND | ND | 1,31E-04 | 8,91E-04 | 4,60E-03 | 6,70E-04 | -9,34E-01 |
| Acronyms | GWP-fossil = Global Warming Potential fossil fuels; GWP-biogenic = Global Warming Potential biogenic; GWP-luluc = Global Warming Potential land use and land use change; ODP = Depletion potential of the stratospheric ozone layer; AP = Acidification potential, Accumulated Exceedance; EP-freshwater = Eutrophication potential, fraction of nutrients reaching freshwater end compartment; EP-marine = Eutrophication potential, fraction of nutrients reaching marine end compartment; EP-terrestrial = Eutrophication potential, Accumulated Exceedance; POCP = Formation potential of tropospheric ozone; ADP-minerals&metals = Abiotic depletion potential for non-fossil resources; ADP-fossil = Abiotic depletion for fossil resources potential; WDP = Water (user) deprivation potential, deprivation-weighted water consumption | | | | | | | | | | | | | | | |

*** DISCLAIMER:**

The results of this environmental impact indicator shall be used with care as the uncertainties of these results are high or as there is limited experience with the indicator.

Additional mandatory and voluntary impact category indicators

| RESULTS PER FUNCTIONAL OR DECLARED UNIT | | | | | | | | | | | | | | | | |
|---|-----------------------|----------|----|----------|----|----|----|----|----|----|----|----------|----------|----------|----------|-----------|
| Indicator | Unit | A1-A3 | A4 | A5 | B1 | B2 | B3 | B4 | B5 | B6 | B7 | C1 | C2 | C3 | C4 | D |
| GWP-GHG ¹ | kgCO ₂ eq. | 5,02E+00 | ND | 0,00E+00 | ND | ND | ND | ND | ND | ND | ND | 4,61E-03 | 1,55E-02 | 1,83E-02 | 6,26E-04 | -4,25E+00 |

* This indicator accounts for all greenhouse gases except biogenic carbon dioxide uptake and emissions and biogenic carbon stored in the product. As such, the indicator is identical to GWP-total except that the CF for biogenic CO₂ is set to zero.

Resource use indicators

| RESULTS PER FUNCTIONAL OR DECLARED UNIT | | | | | | | | | | | | | | | | |
|---|----------------|----------|----|----------|----|----|----|----|----|----|----|----------|----------|----------|----------|-----------|
| Indicator | Unit | A1-A3 | A4 | A5 | B1 | B2 | B3 | B4 | B5 | B6 | B7 | C1 | C2 | C3 | C4 | D |
| PERE | MJ | 1,20E+01 | ND | 0,00E+00 | ND | ND | ND | ND | ND | ND | ND | 4,50E-04 | 4,63E-03 | 7,17E-03 | 1,87E-04 | -1,29E+01 |
| PERM | MJ | 0,00E+00 | ND | 0,00E+00 | ND | ND | ND | ND | ND | ND | ND | 0,00E+00 | 0,00E+00 | 0,00E+00 | 0,00E+00 | 0,00E+00 |
| PERT | MJ | 1,20E+01 | ND | 0,00E+00 | ND | ND | ND | ND | ND | ND | ND | 4,50E-04 | 4,63E-03 | 7,17E-03 | 1,87E-04 | -1,29E+01 |
| PENRE | MJ | 6,71E+01 | ND | 0,00E+00 | ND | ND | ND | ND | ND | ND | ND | 5,93E-02 | 2,15E-01 | 2,82E-01 | 1,52E-02 | -5,44E+01 |
| PENRM | MJ | 0,00E+00 | ND | 0,00E+00 | ND | ND | ND | ND | ND | ND | ND | 0,00E+00 | 0,00E+00 | 0,00E+00 | 0,00E+00 | 0,00E+00 |
| PENRT | MJ | 6,71E+01 | ND | 0,00E+00 | ND | ND | ND | ND | ND | ND | ND | 5,93E-02 | 2,15E-01 | 2,82E-01 | 1,52E-02 | -5,44E+01 |
| SM | kg | 6,68E-01 | ND | 0,00E+00 | ND | ND | ND | ND | ND | ND | ND | 2,54E-05 | 9,23E-05 | 3,31E-05 | 3,81E-06 | -4,66E-01 |
| RSF | MJ | 0,00E+00 | ND | 0,00E+00 | ND | ND | ND | ND | ND | ND | ND | 0,00E+00 | 0,00E+00 | 0,00E+00 | 0,00E+00 | 0,00E+00 |
| NRSF | MJ | 0,00E+00 | ND | 0,00E+00 | ND | ND | ND | ND | ND | ND | ND | 0,00E+00 | 0,00E+00 | 0,00E+00 | 0,00E+00 | 0,00E+00 |
| FW | m ³ | 6,02E-02 | ND | 0,00E+00 | ND | ND | ND | ND | ND | ND | ND | 4,25E-06 | 3,24E-05 | 5,85E-05 | 1,59E-05 | -1,90E-02 |

Acronyms
 PERE = Use of renewable primary energy excluding renewable primary energy resources used as raw materials; PERM = Use of renewable primary energy resources used as raw materials; PERT = Total use of renewable primary energy resources; PENRE = Use of non-renewable primary energy excluding non-renewable primary energy resources used as raw materials; PENRM = Use of non-renewable primary energy resources used as raw materials; PENRT = Total use of non-renewable primary energy resources; SM = Use of secondary material; RSF = Use of renewable secondary fuels; NRSF = Use of non-renewable secondary fuels; FW = Use of net fresh water

Waste indicators

| RESULTS PER FUNCTIONAL OR DECLARED UNIT | | | | | | | | | | | | | | | | |
|---|------|----------|----|----------|----|----|----|----|----|----|----|----------|----------|----------|----------|-----------|
| Indicator | Unit | A1-A3 | A4 | A5 | B1 | B2 | B3 | B4 | B5 | B6 | B7 | C1 | C2 | C3 | C4 | D |
| Hazardous waste disposed | kg | 9,68E-01 | ND | 0,00E+00 | ND | ND | ND | ND | ND | ND | ND | 4,17E-05 | 3,57E-04 | 1,03E-04 | 1,73E-05 | -4,29E-01 |
| Non-hazardous waste disposed | kg | 3,45E+00 | ND | 0,00E+00 | ND | ND | ND | ND | ND | ND | ND | 1,80E-04 | 2,12E-02 | 5,12E-03 | 1,70E-04 | -1,66E+00 |
| Radioactive waste disposed | kg | 1,86E-03 | ND | 0,00E+00 | ND | ND | ND | ND | ND | ND | ND | 7,01E-08 | 7,50E-07 | 1,95E-06 | 2,52E-08 | -6,52E-04 |

Output flow indicators

| RESULTS PER FUNCTIONAL OR DECLARED UNIT | | | | | | | | | | | | | | | | |
|---|------|----------|----|----------|----|----|----|----|----|----|----|----------|----------|----------|----------|-----------|
| Indicator | Unit | A1-A3 | A4 | A5 | B1 | B2 | B3 | B4 | B5 | B6 | B7 | C1 | C2 | C3 | C4 | D |
| Components for re-use | kg | 0,00E+00 | ND | 0,00E+00 | ND | ND | ND | ND | ND | ND | ND | 0,00E+00 | 0,00E+00 | 0,00E+00 | 0,00E+00 | 0,00E+00 |
| Material for recycling | kg | 1,03E+00 | ND | 0,00E+00 | ND | ND | ND | ND | ND | ND | ND | 1,08E-07 | 1,32E-06 | 9,27E-07 | 6,33E-08 | -8,33E-01 |
| Materials for energy recovery | kg | 0,00E+00 | ND | 0,00E+00 | ND | ND | ND | ND | ND | ND | ND | 0,00E+00 | 0,00E+00 | 0,00E+00 | 0,00E+00 | 0,00E+00 |
| Exported energy, electricity | MJ | 0,00E+00 | ND | 0,00E+00 | ND | ND | ND | ND | ND | ND | ND | 0,00E+00 | 0,00E+00 | 0,00E+00 | 0,00E+00 | 0,00E+00 |
| Exported energy, thermal | MJ | 0,00E+00 | ND | 0,00E+00 | ND | ND | ND | ND | ND | ND | ND | 0,00E+00 | 0,00E+00 | 0,00E+00 | 0,00E+00 | 0,00E+00 |



Additional environmental information

SUSTAINABILITY STRATEGY

Analysis of the main aspects

The material aspects, on which Raccorderie Metalliche has focused its attention, both with reference to sustainability reporting and the definition of the strategic intervention plan, have been identified through a process of analysis of company activities, relations with stakeholders and the context in which the company operates, in order to identify the main aspects of impact, actual and potential.

Specifically, the identification of the material aspects derives from a progressive process of:

- Verification of the company's positioning with respect to the relevant issues of sustainability and social responsibility, benchmarked to comparable national and international operators, subjected of a specific study conducted in 2021 by the SDA Bocconi School of Management;
- Dialogue with the owners and top management, aimed at refining the identified issues, also by contextualizing them with respect to company activities;
- Interaction with some categories of key stakeholders, such as operators and financial partners, particularly interested in some specific aspects of concerns;
- Administration of a survey questionnaire to the main internal and external stakeholders (employees, customers, suppliers), aimed at collecting precise indications regarding the relevance of the topics.

The combination of the results obtained from the assessments was used to construct the materiality matrix, shown below, which identifies the issues considered "material" by Raccorderie Metalliche and on which the contents of this document will focus. In particular, the materiality matrix shows the relevance of each material topic for Raccorderie Metalliche on the horizontal axis, and the relevance of the same for the stakeholders on the vertical axis.

The materiality matrix shows the most relevant topics such as "Compliance with standards and laws", "Ethics and governance", "Workers' health and safety" and "Process and product innovation". The material topics are consistent with the sustainability plan, demonstrating Raccorderie Metalliche strong commitment to listening to its stakeholders.

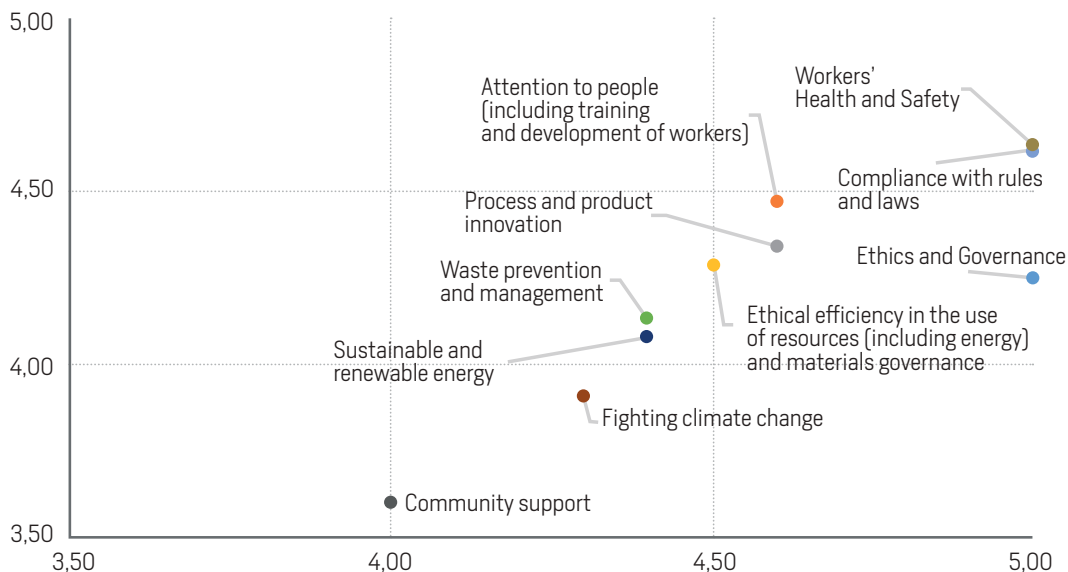

SUSTAINABILITY PLAN

The plan is organized according to the following guidelines:

- Medium-term, periodically evaluated, updated, and integrated based on the progressive achievement of objectives and a continuous improvement approach;
- Alignment with the most recent international and national trends, on the fight against climate change and the reduction of GHG emissions (greenhouse gas), energy efficiency, circularity, fight against inequalities, promotion of equal opportunities, safeguarding of people's health and well-being, creation and diffusion of sustainable value;
- Definition of qualitative and quantitative objectives, targets and KPIs, aimed at the continuous monitoring of the efforts and initiatives implemented.



These SDGs have been integrated into the sustainability plan and broken down into objectives, targets and KPIs. The sustainability strategy sets out Raccorderie Metalliche commitments to sustainable development.



SUSTAINABILITY STRATEGY AND PILLARS OF THE SUSTAINABILITY PLAN

Alignment SDG



Strategy & Pillars of the Sustainability Plan

Sustainability Governance

Raccorderie Metalliche adopts the highest principles of responsibility and transparency, inspired by the most UpToDate standards and best practices. In terms of sustainable development, the Company directs its initiatives according to the objectives of the United Nations 2030 Agenda.

Material Aspects

- Ethics & Governance
- Respect of Rules & Regulations
- Innovation of processes & products
- Sustainable & Renewable Energy
- Community service
- Health, Safety & Well-being of stakeholders
- People Oriented
- Attention to the Environment



People

Raccorderie Metalliche recognizes human development, well-being, and people's safety as a key element. For this reason, it is committed to ensure the professional and intellectual growth of all its employees and collaborators, ensure the well-being and safety in the workplace, and in all relationships.



Planet

Raccorderie Metalliche considers sustainable development as key element of its strategies, paying attention to all the environmental aspects associated with its activities.

Specific aspects of concern are energy efficiency, emissions reduction, efficient use of natural resources, process and product.



Prosperity

Raccorderie Metalliche conscious of its role in the community, committed towards the generation of shared value for employees, suppliers, customers, shareholders, and the society, through the creation of well-being and prosperity for a more equal and inclusive society, directly or indirectly supporting the social fabric and vitality of the community in which it operates.

Stakeholders

- Customers
- Employees
- Suppliers
- Community & Territory
- Natural Environment
- Certifications Bodies
- Banks & Financial Providers
- Central & Local Public Administration
- Shareholders

The Governance of Sustainability

ETHIC CODE

Raccorderie Metalliche has adopted a Code of Ethics since October 2013, sensitive to the need to comply in its corporate mission with the highest ethical-social principles.

The Code of Ethics, identified as a founding component of the Company's organizational model and internal control and risk management system, is placed upstream of the entire Corporate Governance system and represents the company's charter of values, becoming the corpus of principles which inspire the actions of the members of the corporate bodies, management, commercial partners, as well as internal and external stakeholders.

The Code of Ethics therefore constitutes a tool through which Raccorderie Metalliche directs its business activities based on the following values: entrepreneurship and innovation, social commitment, tradition and experience, courage and credibility, ethics, legality, transparency, fairness, honesty.

MODEL OF ORGANISATION, MANAGEMENT AND CONTROL

In 2015 Raccorderie Metalliche introduce the Organisation, Management and Control Model (MOGC) in compliance with the Legislative Decree No. 231 of 8/06/2001.

The Legislative Decree 231/2001 introduces for the first time into the corporate system the notion of "administrative" liability of the Associative Entity for crimes committed to its advantage by directors, "top management", employees or collaborators. Raccorderie Metalliche guarantees maximum professional responsibility by strictly observing ethical and social standards.

SYSTEM AND PRODUCTS CERTIFICATIONS

ISO 9001:2015 QUALITY MANAGEMENT SYSTEM

Since 1994, date of the first ISO:9001 certification, Raccorderie Metalliche has applied procedures within its organization to eliminate waste, be more competitive and create value for customers. This philosophy requires the whole company to be active in continuous improvements and controls on products quality, which had allowed the creation of high-quality standard.

ISO 14001:2015 ENVIRONMENTAL MANAGEMENT SYSTEM

Environmental issues are managed by Raccorderie Metalliche in compliance with the international standard ISO 14001:2015, through the implementation of an Integrated Management System for the Environment and Work Safety certified according to the international reference standard.

ISO 45001:2018 HEALTH AND SAFETY MANAGEMENT SYSTEM

Raccorderie Metalliche has adopted the ISO 45001:2018 standard to make all activities on the health and safety in the workplace formalized. The certification attests the commitment of the company to create and sustain a system able to guarantee an adequate control regarding the safety and health of employees and to protect them from possible dangers.

ISO 50001:2018 ENERGY MANAGEMENT SYSTEM

With ISO 50001 Raccorderie Metalliche completes the integrated management system which includes the 4 relevant ISO certifications: QUALITY - SAFETY - ENVIRONMENT - ENERGY. The objective of the ISO 50001 standard is in fact to allow organizations to create and maintain an Energy Management System (EMS) that allows them to continuously improve their energy performance. ISO 50001 specifies the requirements that an energy management system (ENMS/SGE) must have, enabling an organization to have a systematic approach for continuous improvement of its energy performance, also taking legal obligations into account.

Respect for the Environment

Raccorderie Metalliche operates with a view to eco-compatible growth also through the adoption of technologies and production methods that allow to reduce the environmental impact of its activities.

To increase its energy self-sufficiency, to contribute to the reduction of greenhouse gas emissions, the Company has installed a 3,501 kWp photovoltaic system covering the roofs of its production site in Campitello di Marcara.

In this way the company will be able to independently produce approximately 20%-25% of its energy directly from a clean and renewable source. This plant has been productive since 5 December 2022 and produced 32,788 kWh in 25 days, thus bringing the value of renewable electricity to 2.0% of the company's needs. This photovoltaic system manufactured with certified crystalline silicon modules, fire resistance and installed only on the roof portions not subject to shading.

As per design the installation included:

- Screens for displaying the electricity produced, the instantaneous power of the system and the CO₂ emissions avoided;
- Monitor for viewing the synoptic of the monitoring system;
- Solarimeters connected to the system monitoring system for the continuous measurement and storing of irradiation values;
- Installation monitoring system connected online able to timely reporting any malfunctions
- Seven cars charging stations.



64



Other Information

PRODUCT TABLE



116/200

TUBO PER GAS

- PIPE FOR GAS
- ROHR FÜR GAS
- TUBE POUR LE GAZ
- TUBO PARA EL GAS

NORM: EN 10217-7 (DIN 17455) - EN 10312

Mat. Nr.: 1.4404 (AISI 316L) L=6 m
Crudo - Not annealed - Ungeglüht - Non-hypertrempé - Crudo

| CODE | Description | Weight [kg/m] |
|-----------|---|---------------|
| 116015200 | Inoxpres pipe 316L 15x1x6000 N/anne. | 0,351 |
| 116018200 | Inoxpres pipe 316L 18x1x6000 N/anne. | 0,426 |
| 116022200 | Inoxpres pipe 316L 22x1,2x6000 N/anne. | 0,625 |
| 116028200 | Inoxpres pipe 316L 28x1,2x6000 N/anne. | 0,805 |
| 116035200 | Inoxpres pipe 316L 35x1,5x6000 N/anne. | 1,258 |
| 116042200 | Inoxpres pipe 316L 42x1,5x6000 N/anne. | 1,521 |
| 116054200 | Inoxpres pipe 316L 54x1,5x6000 N/anne. | 1,972 |
| 116076200 | Inoxpres pipe 316L 76,1x2x6000 N/anne. | 3,711 |
| 116088200 | Inoxpres pipe 316L 88,9x2x6000 N/anne. | 4,352 |
| 116108200 | Inoxpres pipe 316L 108x2x6000 N/anne. | 5,308 |
| 116139200 | Inoxpres pipe 316L 139,7x2x6000 N/anne. | 6,896 |
| 116168200 | Inoxpres pipe 316L 168,3x2x6000 N/anne. | 8,328 |
| 116139260 | Inoxpres pipe 316L 139x2,6x6000 N/anne. | 8,926 |
| 116168260 | Inoxpres pipe 316L 168x2,6x6000 N/anne. | 10,788 |
| 116015203 | Inoxpres pipe 316L 15x1x3000 N/anne. | 0,351 |
| 116018203 | Inoxpres pipe 316L 18x1x3000 N/anne. | 0,426 |
| 116022203 | Inoxpres pipe 316L 22x1,2x3000 N/anne. | 0,625 |
| 116028203 | Inoxpres pipe 316L 28x1,2x3000 N/anne. | 0,805 |
| 116035203 | Inoxpres pipe 316L 35x1,5x3000 N/anne. | 1,258 |
| 116042203 | Inoxpres pipe 316L 42x1,5x3000 N/anne. | 1,521 |
| 116054203 | Inoxpres pipe 316L 54x1,5x3000 N/anne. | 1,972 |
| 116076203 | Inoxpres pipe 316L 76,1x2x3000 N/anne. | 3,711 |
| 116088203 | Inoxpres pipe 316L 88,9x2x3000 N/anne. | 4,352 |
| 116108203 | Inoxpres pipe 316L 108x2x3000 N/anne. | 5,308 |
| 116015300 | Inoxpres pipe 316L 15x1x6000 annealed | 0,351 |
| 116018300 | Inoxpres pipe 316L 18x1x6000 annealed | 0,426 |
| 116022300 | Inoxpres pipe 316L 22x1,2x6000 annealed | 0,625 |
| 116028300 | Inoxpres pipe 316L 28x1,2x6000 annealed | 0,805 |
| 116035300 | Inoxpres pipe 316L 35x1,5x6000 annealed | 1,258 |
| 116042300 | Inoxpres pipe 316L 42x1,5x6000 annealed | 1,521 |
| 116054300 | Inoxpres pipe 316L 54x1,5x6000 annealed | 1,972 |
| 116076300 | Inoxpres pipe 316L 76,1x2x6000 annealed | 3,711 |



116/200

TUBO PER GAS

- PIPE FOR GAS
- ROHR FÜR GAS
- TUBE POUR LE GAZ
- TUBO PARA EL GAS

NORM: EN 10217-7 (DIN 17455) - EN 10312

Mat. Nr.: 1.4404 (AISI 316L) L=6 m
Crudo - Not annealed - Ungeglüht - Non-hypertrempé - Crudo

| CODE | Description | Weight [kg/m] |
|-----------|---|---------------|
| 116088300 | Inoxpres pipe 316L 88,9x2x6000 annealed | 4,352 |
| 116108300 | Inoxpres pipe 316L 108x2x6000 annealed | 5,308 |
| 116015030 | Inoxpres pipe 444 15x1x6000 annealed | 0,351 |
| 116018030 | Inoxpres pipe 444 18x1x6000 annealed | 0,426 |
| 116022030 | Inoxpres pipe 444 22x1,2x6000 annealed | 0,625 |
| 116028030 | Inoxpres pipe 444 28x1,2x6000 annealed | 0,805 |
| 116035030 | Inoxpres pipe 444 35x1,5x6000 annealed | 1,258 |
| 116042030 | Inoxpres pipe 444 42x1,5x6000 annealed | 1,521 |
| 116054030 | Inoxpres pipe 444 54x1,5x6000 annealed | 1,972 |
| 114015200 | Inoxpres pipe 304L 15x1x6000 N/anne. | 0,351 |
| 114018200 | Inoxpres pipe 304L 18x1x6000 N/anne. | 0,426 |
| 114022200 | Inoxpres pipe 304L 22x1,2x6000 N/anne. | 0,625 |
| 114028200 | Inoxpres pipe 304L 28x1,2x6000 N/anne. | 0,805 |
| 114035200 | Inoxpres pipe 304L 35x1,5x6000 N/anne. | 1,258 |
| 114042200 | Inoxpres pipe 304L 42x1,5x6000 N/anne. | 1,521 |
| 114054200 | Inoxpres pipe 304L 54x1,5x6000 N/anne. | 1,972 |
| 114076200 | Inoxpres pipe 304L 76,1x2x6000 N/anne. | 3,711 |
| 114088200 | Inoxpres pipe 304L 88,9x2x6000 N/anne. | 4,352 |
| 114108200 | Inoxpres pipe 304L 108x2x6000 N/anne. | 5,308 |

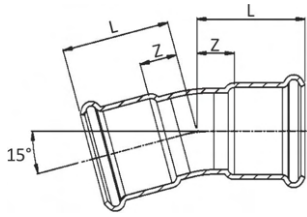

181/150

CURVA 15° FF

- 15° ELBOW FF
- BOGEN 15° II
- COUDE FF 15°
- CURVA 15° HH

MATERIAL: AISI 316L – 1.4404

O-RING: EPDM nero - black - Schwarz - noir - negro

| CODE | Description | Weight [kg] |
|------------|--------------------------------------|-------------|
| 181015150 | Inoxpres elbow 15° FF Ø 15 | 0,05 |
| 181018150 | Inoxpres elbow 15° FF Ø 18 | 0,052 |
| 181022150 | Inoxpres elbow 15° FF Ø 22 | 0,082 |
| 181028150 | Inoxpres elbow 15° FF Ø 28 | 0,112 |
| 181035150 | Inoxpres elbow 15° FF Ø 35 | 0,123 |
| 181042150 | Inoxpres elbow 15° FF Ø 42 | 0,175 |
| 181054150 | Inoxpres elbow 15° FF Ø 54 | 0,268 |
| 181076150C | Inoxpres elbow 15° FF Ø 76,1 – short | 0,777 |
| 181088150C | Inoxpres elbow 15° FF Ø 88,9 – short | 1,032 |
| 181108150C | Inoxpres elbow 15° FF Ø 108 – short | 1,412 |

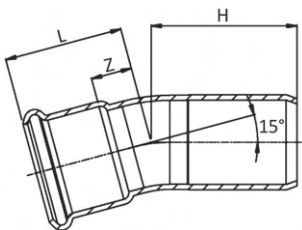

181/151

CURVA 15° MF

- 15° ELBOW MF
- BOGEN 15° IA
- COUDE MF 15°
- CURVA 15° HM

MATERIAL: AISI 316L – 1.4404

O-RING: EPDM nero - black - Schwarz - noir - negro

| CODE | Description | Weight [kg] |
|------------|--------------------------------------|-------------|
| 181015151 | Inoxpres elbow 15° MF Ø 15 | 0,05 |
| 181022151 | Inoxpres elbow 15° MF Ø 22 | 0,082 |
| 181028151 | Inoxpres elbow 15° MF Ø 28 | 0,112 |
| 181035151 | Inoxpres elbow 15° MF Ø 35 | 0,133 |
| 181042151 | Inoxpres elbow 15° MF Ø 42 | 0,165 |
| 181054151 | Inoxpres elbow 15° MF Ø 54 | 0,293 |
| 181076151C | Inoxpres elbow 15° MF Ø 76,1 – short | 0,743 |
| 181088151C | Inoxpres elbow 15° MF Ø 88,9 – short | 0,988 |
| 181108151C | Inoxpres elbow 15° MF Ø 108 – short | 1,332 |

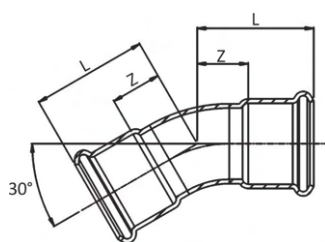

181/300

CURVA 30° FF

- 30° ELBOW FF
- BOGEN 30° II
- COUDE FF 30°
- CURVA 30° HH

MATERIAL: AISI 316L – 1.4404

O-RING: EPDM nero – black – Schwarz – noir – negro

| CODE | Description | Weight [kg] |
|-----------|------------------------------|-------------|
| 181015300 | Inoxpres elbow 30° FF Ø 15 | 0,05 |
| 181018300 | Inoxpres elbow 30° FF Ø 18 | 0,052 |
| 181022300 | Inoxpres elbow 30° FF Ø 22 | 0,082 |
| 181028300 | Inoxpres elbow 30° FF Ø 28 | 0,112 |
| 181035300 | Inoxpres elbow 30° FF Ø 35 | 0,123 |
| 181042300 | Inoxpres elbow 30° FF Ø 42 | 0,175 |
| 181054300 | Inoxpres elbow 30° FF Ø 54 | 0,268 |
| 181076300 | Inoxpres elbow 30° FF Ø 76,1 | 0,9 |
| 181088300 | Inoxpres elbow 30° FF Ø 88,9 | 1,25 |
| 181108300 | Inoxpres elbow 30° FF Ø 108 | 1,7 |

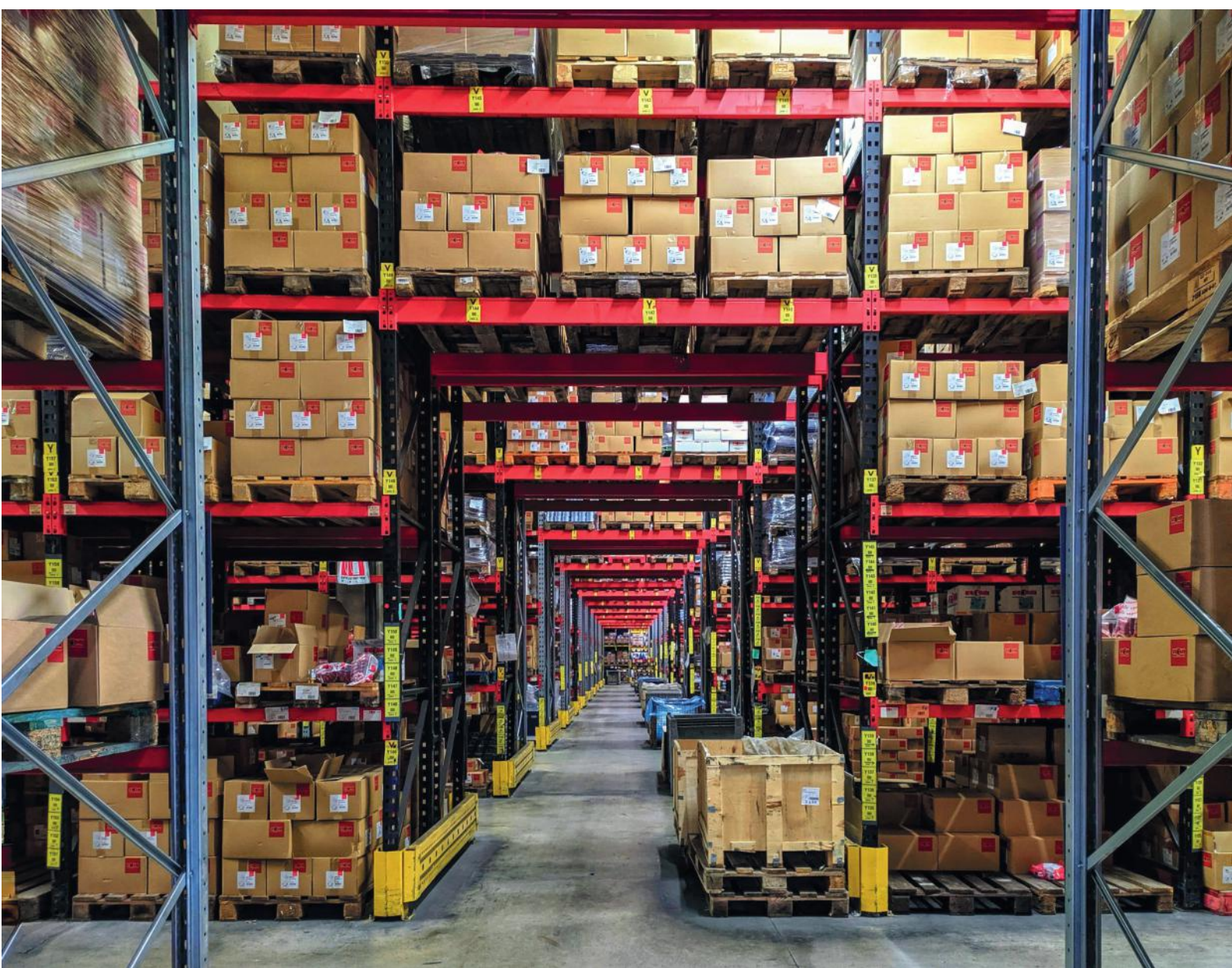

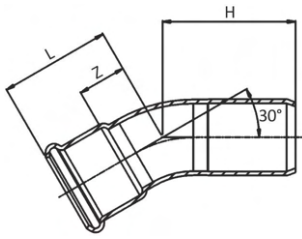

181/301

CURVA 30° MF

- 30° ELBOW MF
- BOGEN 30° IA
- COUDE MF 30°
- CURVA 30° HM

MATERIAL: AISI 316L – 1.4404

O-RING: EPDM nero – black – Schwarz – noir – negro

| CODE | Description | Weight [kg] |
|-----------|------------------------------|-------------|
| 181015301 | Inoxpres elbow 30° MF Ø 15 | 0,05 |
| 181022301 | Inoxpres elbow 30° MF Ø 22 | 0,082 |
| 181028301 | Inoxpres elbow 30° MF Ø 28 | 0,112 |
| 181035301 | Inoxpres elbow 30° MF Ø 35 | 0,133 |
| 181042301 | Inoxpres elbow 30° MF Ø 42 | 0,195 |
| 181054301 | Inoxpres elbow 30° MF Ø 54 | 0,293 |
| 181076301 | Inoxpres elbow 30° MF Ø 76,1 | 0,9 |
| 181088301 | Inoxpres elbow 30° MF Ø 88,9 | 1,25 |
| 181108301 | Inoxpres elbow 30° MF Ø 108 | 1,7 |

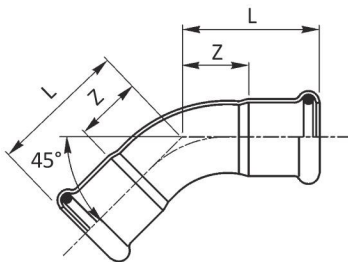

181/450

CURVA 45° FF

- 45° ELBOW FF
- BOGEN 45° II
- COUDE FF 45°
- CURVA 45° HH

MATERIAL: AISI 316L – 1.4404

O-RING: EPDM nero – black – Schwarz – noir – negro

| CODE | Description | Weight [kg] |
|------------|---------------------------------|-------------|
| 181015450C | Inoxpres elbow 45° FF Ø 15 – SR | 0,039 |
| 181018450C | Inoxpres elbow 45° FF Ø 18 – SR | 0,048 |
| 181022450C | Inoxpres elbow 45° FF Ø 22 – SR | 0,063 |
| 181028450C | Inoxpres elbow 45° FF Ø 28 – SR | 0,09 |
| 181035450 | Inoxpres elbow 45° FF Ø 35 | 0,127 |
| 181042450 | Inoxpres elbow 45° FF Ø 42 | 0,177 |
| 181054450 | Inoxpres elbow 45° FF Ø 54 | 0,273 |
| 181076450 | Inoxpres elbow 45° FF Ø 76,1 | 0,9 |
| 181088450 | Inoxpres elbow 45° FF Ø 88,9 | 1,25 |
| 181108450 | Inoxpres elbow 45° FF Ø 108 | 1,7 |
| 181139450 | Inoxpres elbow 45° FF Ø 139,7 | 3,052 |
| 181168450 | Inoxpres elbow 45° FF Ø 168,3 | 4,556 |

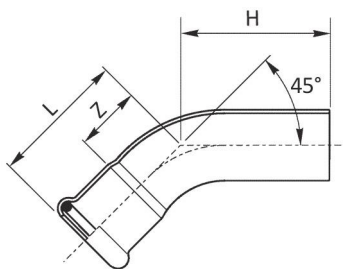

181/451

CURVA 45° MF

- 45° ELBOW MF
- BOGEN 45° IA
- COUDE MF 45°
- CURVA 45° HM

MATERIAL: AISI 316L – 1.4404

O-RING: EPDM nero - black - Schwarz - noir - negro

| CODE | Description | Weight [kg] |
|------------|---------------------------------|-------------|
| 181015451C | Inoxpres elbow 45° MF Ø 15 - SR | 0,038 |
| 181018451C | Inoxpres elbow 45° MF Ø 18 - SR | 0,047 |
| 181022451C | Inoxpres elbow 45° MF Ø 22 - SR | 0,063 |
| 181028451C | Inoxpres elbow 45° MF Ø 28 - SR | 0,09 |
| 181035451 | Inoxpres elbow 45° MF Ø 35 | 0,132 |
| 181042451 | Inoxpres elbow 45° MF Ø 42 | 0,196 |
| 181054451 | Inoxpres elbow 45° MF Ø 54 | 0,296 |
| 181076451 | Inoxpres elbow 45° MF Ø 76,1 | 0,9 |
| 181088451 | Inoxpres elbow 45° MF Ø 88,9 | 1,25 |
| 181108451 | Inoxpres elbow 45° MF Ø 108 | 1,7 |
| 181139451 | Inoxpres elbow 45° MF Ø 139,7 | 2,947 |
| 181168451 | Inoxpres elbow 45° MF Ø 168,3 | 4,346 |

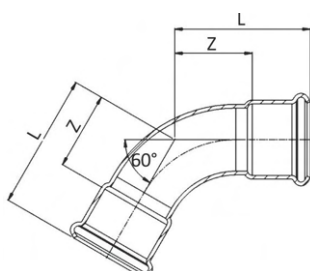

181/600

CURVA 60° FF

- 60° ELBOW FF
- BOGEN 60° II
- COUDE FF 60°
- CURVA 60° HH

MATERIAL: AISI 316L – 1.4404

O-RING: EPDM nero - black - Schwarz - noir - negro

| CODE | Description | Weight [kg] |
|-----------|------------------------------|-------------|
| 181015600 | Inoxpres elbow 60° FF Ø 15 | 0,041 |
| 181018600 | Inoxpres elbow 60° FF Ø 18 | 0,05 |
| 181022600 | Inoxpres elbow 60° FF Ø 22 | 0,068 |
| 181028600 | Inoxpres elbow 60° FF Ø 28 | 0,098 |
| 181035600 | Inoxpres elbow 60° FF Ø 35 | 0,141 |
| 181042600 | Inoxpres elbow 60° FF Ø 42 | 0,204 |
| 181054600 | Inoxpres elbow 60° FF Ø 54 | 0,313 |
| 181076600 | Inoxpres elbow 60° FF Ø 76,1 | 1,178 |
| 181088600 | Inoxpres elbow 60° FF Ø 88,9 | 1,517 |
| 181108600 | Inoxpres elbow 60° FF Ø 108 | 2,194 |

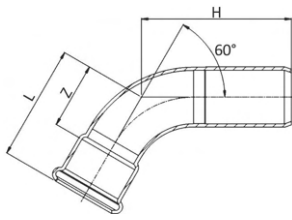

181/601

CURVA 60° MF

- 60° ELBOW MF
- BOGEN 60° IA
- COUDE MF 60°
- CURVA 60° HM

MATERIAL: AISI 316L – 1.4404

O-RING: EPDM nero - black - Schwarz - noir - negro

| CODE | Description | Weight [kg] |
|-----------|------------------------------|-------------|
| 181015601 | Inoxpres elbow 60° MF Ø 15 | 0,04 |
| 181018601 | Inoxpres elbow 60° MF Ø 18 | 0,05 |
| 181022601 | Inoxpres elbow 60° MF Ø 22 | 0,068 |
| 181028601 | Inoxpres elbow 60° MF Ø 28 | 0,098 |
| 181035601 | Inoxpres elbow 60° MF Ø 35 | 0,149 |
| 181042601 | Inoxpres elbow 60° MF Ø 42 | 0,22 |
| 181054601 | Inoxpres elbow 60° MF Ø 54 | 0,332 |
| 181076601 | Inoxpres elbow 60° MF Ø 76,1 | 1,179 |
| 181088601 | Inoxpres elbow 60° MF Ø 88,9 | 1,503 |
| 181108601 | Inoxpres elbow 60° MF Ø 108 | 2,148 |

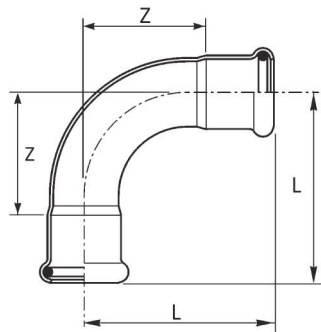

181/900

CURVA 90° FF

- 90° ELBOW FF
- BOGEN 90° II
- COUDE FF 90°
- CURVA 90° HH

MATERIAL: AISI 316L – 1.4404

O-RING: EPDM nero - black - Schwarz - noir - negro

| CODE | Description | Weight [kg] |
|------------|---------------------------------|-------------|
| 181015900C | Inoxpres elbow 90° FF Ø 15 - SR | 0,046 |
| 181018900C | Inoxpres elbow 90° FF Ø 18 - SR | 0,058 |
| 181022900C | Inoxpres elbow 90° FF Ø 22 - SR | 0,078 |
| 181028900C | Inoxpres elbow 90° FF Ø 28 - SR | 0,116 |
| 181035900 | Inoxpres elbow 90° FF Ø 35 | 0,162 |
| 181042900 | Inoxpres elbow 90° FF Ø 42 | 0,231 |
| 181054900 | Inoxpres elbow 90° FF Ø 54 | 0,367 |
| 181076900 | Inoxpres elbow 90° FF Ø 76,1 | 1,15 |
| 181088900 | Inoxpres elbow 90° FF Ø 88,9 | 1,58 |
| 181108900 | Inoxpres elbow 90° FF Ø 108 | 2,25 |
| 181139900 | Inoxpres elbow 90° FF Ø 139,7 | 4,082 |
| 181168900 | Inoxpres elbow 90° FF Ø 168,3 | 6,059 |

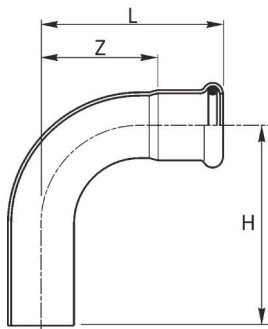

181/901

CURVA 90° MF

- 90° ELBOW MF
- BOGEN 90° IA
- COUDE MF 90°
- CURVA 90° HM

MATERIAL: AISI 316L – 1.4404

O-RING: EPDM nero - black - Schwarz - noir - negro

| CODE | Description | Weight [kg] |
|------------|------------------------------------|-------------|
| 181015901C | Inoxpres elbow 90° MF Ø 15 - SR | 0,046 |
| 181018901C | Inoxpres elbow 90° MF Ø 18 - SR | 0,056 |
| 181022901C | Inoxpres elbow 90° MF Ø 22 - SR | 0,079 |
| 181028901C | Inoxpres elbow 90° MF Ø 28 - SR | 0,115 |
| 181035901 | Inoxpres elbow 90° MF Ø 35 | 0,176 |
| 181042901 | Inoxpres elbow 90° MF Ø 42 | 0,253 |
| 181054901 | Inoxpres elbow 90° MF Ø 54 | 0,39 |
| 181076901 | Inoxpres elbow 90° MF Ø 76,1 | 1,15 |
| 181088901 | Inoxpres elbow 90° MF Ø 88,9 | 1,58 |
| 181108901 | Inoxpres elbow 90° MF Ø 108 | 2,25 |
| 181139901 | Inoxpres elbow 90° MF Ø 139,7 | 3,984 |
| 181168901 | Inoxpres elbow 90° MF Ø 168,3 | 5,991 |
| 186102015C | Inoxpres elbow 90° MM 1/2"x15 - SR | 0,085 |



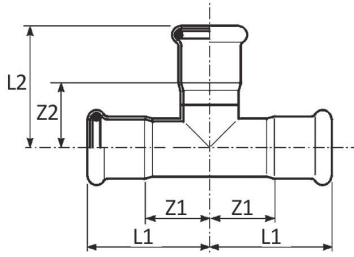

182

“T”

- EQUAL TEE
- T-STÜCK
- TÉ ÉGAL
- TE IGUAL HHH

MATERIAL: AISI 316L - 1.4404

O-RING: EPDM nero - black - Schwarz - noir - negro

| CODE | Description | Weight [kg] |
|-----------|----------------------------|-------------|
| 182015000 | Inoxpres equal tee Ø 15 | 0,067 |
| 182018000 | Inoxpres equal tee Ø 18 | 0,08 |
| 182022000 | Inoxpres equal tee Ø 22 | 0,106 |
| 182028000 | Inoxpres equal tee Ø 28 | 0,145 |
| 182035000 | Inoxpres equal tee Ø 35 | 0,201 |
| 182042000 | Inoxpres equal tee Ø 42 | 0,26 |
| 182054000 | Inoxpres equal tee Ø 54 | 0,404 |
| 182076000 | Inoxpres equal tee Ø 76,1 | 1,275 |
| 182088000 | Inoxpres equal tee Ø 88,9 | 1,535 |
| 182108000 | Inoxpres equal tee Ø 108 | 2,115 |
| 182139000 | Inoxpres equal tee Ø 139,7 | 4,129 |
| 182168000 | Inoxpres equal tee Ø 168,3 | 6,321 |



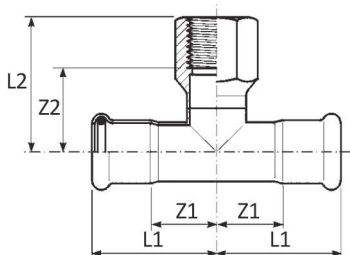

189

"T" CON DERIVAZIONE FILETTO F

- BRANCH TEE FEMALE BSP OUTLET
- T-STÜCK MIT ABGANG IG
- TÉ MIXTE AVEC FILETAGE F
- TE HEMBRA ROSCADA

MATERIAL: AISI 316L – 1.4404

O-RING: EPDM nero - black - Schwarz - noir - negro

THREAD: EN 10226-1 (ex ISO 7/1)

| CODE | Description | Weight [kg] |
|-----------|--------------------------|-------------|
| 189102015 | Inoxpres tee F 1/2"x15 | 0,117 |
| 189102018 | Inoxpres tee F 1/2"x18 | 0,128 |
| 189304018 | Inoxpres tee F 3/4"x18 | 0,147 |
| 189102022 | Inoxpres tee F 1/2"x22 | 0,159 |
| 189304022 | Inoxpres tee F 3/4"x22 | 0,184 |
| 189102028 | Inoxpres tee F 1/2"x28 | 0,217 |
| 189304028 | Inoxpres tee F 3/4"x28 | 0,221 |
| 189100028 | Inoxpres tee F 1"x28 | 0,266 |
| 189102035 | Inoxpres tee F 1/2"x35 | 0,197 |
| 189304035 | Inoxpres tee F 3/4"x35 | 0,205 |
| 189100035 | Inoxpres tee F 1"x35 | 0,282 |
| 189102042 | Inoxpres tee F 1/2"x42 | 0,271 |
| 189304042 | Inoxpres tee F 3/4"x42 | 0,277 |
| 189100042 | Inoxpres tee F 1"x42 | 0,346 |
| 189102054 | Inoxpres tee F 1/2"x54 | 0,377 |
| 189304054 | Inoxpres tee F 3/4"x54 | 0,391 |
| 189200054 | Inoxpres tee F 2"x54 | 0,838 |
| 189304076 | Inoxpres tee F 3/4"x76,1 | 1,04 |
| 189100076 | Inoxpres tee F 1"x76,1 | 1,063 |
| 189200076 | Inoxpres tee F 2"x76,1 | 1,495 |
| 189304088 | Inoxpres tee F 3/4"x88,9 | 1,255 |
| 189200088 | Inoxpres tee F 2"x88,9 | 1,72 |
| 189304108 | Inoxpres tee F 3/4"x108 | 1,7 |
| 189200108 | Inoxpres tee F 2"x108 | 2,16 |
| 189100139 | Inoxpres tee F 1"x139,7 | 3,126 |
| 189200139 | Inoxpres tee F 2"x139,7 | 3,623 |
| 189100168 | Inoxpres tee F 1"x168,3 | 4,827 |
| 189200168 | Inoxpres tee F 2"x168,3 | 5,325 |

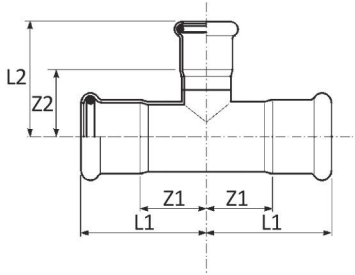

192

“T” RIDOTTO

- REDUCING TEE
- T-STÜCK MIT REDUZIERTEM ABGANG
- TÉ RÉDUIT
- TE REDUCIDA HHH

MATERIAL: AISI 316L – 1.4404

O-RING: EPDM nero - black - Schwarz - noir - negro

| CODE | Description | Weight [kg] |
|-----------|--|-------------|
| 192018015 | Inoxpres reducing tee 18x15x18 | 0,08 |
| 192022015 | Inoxpres reducing tee 22x15x22 | 0,095 |
| 192022018 | Inoxpres reducing tee 22x18x22 | 0,098 |
| 192028015 | Inoxpres reducing tee 28x15x28 | 0,126 |
| 192028018 | Inoxpres reducing tee 28x18x28 | 0,13 |
| 192028022 | Inoxpres reducing tee 28x22x28 | 0,135 |
| 192035015 | Inoxpres reducing tee 35x15x35 | 0,158 |
| 192035018 | Inoxpres reducing tee 35x18x35 | 0,163 |
| 192035022 | Inoxpres reducing tee 35x22x35 | 0,167 |
| 192035028 | Inoxpres reducing tee 35x28x35 | 0,171 |
| 192042018 | Inoxpres reducing tee 42x18x42 | 0,232 |
| 192042022 | Inoxpres reducing tee 42x22x42 | 0,237 |
| 192042028 | Inoxpres reducing tee 42x28x42 | 0,243 |
| 192042035 | Inoxpres reducing tee 42x35x42 | 0,272 |
| 192054018 | Inoxpres reducing tee 54x18x54 | 0,335 |
| 192054022 | Inoxpres reducing tee 54x22x54 | 0,34 |
| 192054028 | Inoxpres reducing tee 54x28x54 | 0,345 |
| 192054035 | Inoxpres reducing tee 54x35x54 | 0,361 |
| 192054042 | Inoxpres reducing tee 54x42x54 | 0,376 |
| 192076022 | Inoxpres reducing tee 76,1x22x76,1 | 0,995 |
| 192076028 | Inoxpres reducing tee 76,1x28x76,1 | 1,015 |
| 192076035 | Inoxpres reducing tee 76,1x35x76,1 | 1,025 |
| 192076042 | Inoxpres reducing tee 76,1x42x76,1 | 1,045 |
| 192076054 | Inoxpres reducing tee 76,1x54x76,1 | 1,065 |
| 192088022 | Inoxpres reducing tee 88,9x22x88,9 | 1,22 |
| 192088028 | Inoxpres reducing tee 88,9x28x88,9 | 1,225 |
| 192088035 | Inoxpres reducing tee 88,9x35x88,9 | 1,245 |
| 192088042 | Inoxpres reducing tee 88,9x42x88,9 | 1,255 |
| 192088054 | Inoxpres reducing tee 88,9x54x88,9 | 1,28 |
| 192088076 | Inoxpres reducing tee 88,9x76,1x88,9 | 1,485 |
| 192108022 | Inoxpres reducing tee 108x22x108 | 1,665 |
| 192108028 | Inoxpres reducing tee 108x28x108 | 1,67 |
| 192108035 | Inoxpres reducing tee 108x35x108 | 1,775 |
| 192108042 | Inoxpres reducing tee 108x42x108 | 1,865 |
| 192108054 | Inoxpres reducing tee 108x54x108 | 1,925 |
| 192108076 | Inoxpres reducing tee 108x76,1x108 | 1,93 |
| 192108088 | Inoxpres reducing tee 108x88,9x108 | 1,965 |
| 192139035 | Inoxpres reducing tee 139,7x35x139,7 | 3,083 |
| 192139076 | Inoxpres reducing tee 139,7x76,1x139,7 | 3,34 |
| 192139088 | Inoxpres reducing tee 139,7x88,9x139,7 | 3,435 |
| 192139108 | Inoxpres reducing tee 139,7x108x139,7 | 3,631 |
| 192168035 | Inoxpres reducing tee 168,3x35x168,3 | 4,784 |

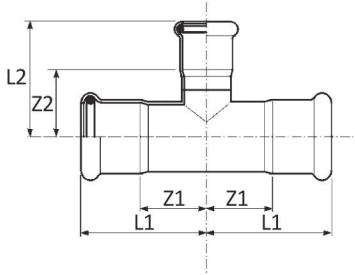

192

"T" RIDOTTO

- REDUCING TEE
- T-STÜCK MIT REDUZIERTEM ABGANG
- TÉ RÉDUIT
- TE REDUCIDA HHH

MATERIAL: AISI 316L - 1.4404

O-RING: EPDM nero - black - Schwarz - noir - negro

| CODE | Description | Weight [kg] |
|-----------|---|-------------|
| 192168076 | Inoxpres reducing tee 168,3x76,1x168,3 | 5,05 |
| 192168088 | Inoxpres reducing tee 168,3x88,9x168,3 | 5,146 |
| 192168108 | Inoxpres reducing tee 168,3x108x168,3 | 5,34 |
| 192168139 | Inoxpres reducing tee 168,3x139,7x168,3 | 5,681 |
| 188028022 | Inoxpres reducing tee MFM 28x22x28 | 0,138 |
| 188035022 | Inoxpres reducing tee MFM 35x22x35 | 0,185 |
| 188035028 | Inoxpres reducing tee MFM 35x28x35 | 0,193 |
| 188042028 | Inoxpres reducing tee MFM 42x28x42 | 0,256 |
| 188054028 | Inoxpres reducing tee MFM 54x28x54 | 0,334 |



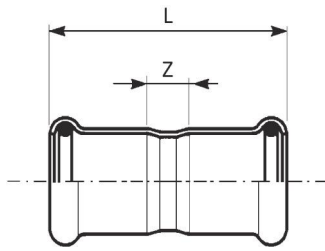

183/000

MANICOTTO

- COUPLING
- MUFFE
- MANCHON
- MANGUITO HH

MATERIAL: AISI 316L - 1.4404

O-RING: EPDM nero - black - Schwarz - noir - negro

| CODE | Description | Weight [kg] |
|-----------|---------------------------|-------------|
| 183015000 | Inoxpres coupling Ø 15 | 0,035 |
| 183018000 | Inoxpres coupling Ø 18 | 0,042 |
| 183022000 | Inoxpres coupling Ø 22 | 0,054 |
| 183028000 | Inoxpres coupling Ø 28 | 0,071 |
| 183035000 | Inoxpres coupling Ø 35 | 0,097 |
| 183042000 | Inoxpres coupling Ø 42 | 0,136 |
| 183054000 | Inoxpres coupling Ø 54 | 0,198 |
| 183076000 | Inoxpres coupling Ø 76,1 | 0,635 |
| 183088000 | Inoxpres coupling Ø 88,9 | 0,765 |
| 183108000 | Inoxpres coupling Ø 108 | 1,17 |
| 183139000 | Inoxpres coupling Ø 139,7 | 2,031 |
| 183168000 | Inoxpres coupling Ø 168,3 | 2,936 |

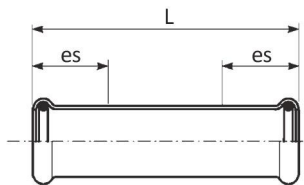

183/001

MANICOTTO PASSANTE

- SLIP COUPLING
- SCHIEBEMUFFE
- MANCHON LONG
- MANGUITO SIN TOPE

MATERIAL: AISI 316L - 1.4404

O-RING: EPDM nero - black - Schwarz - noir - negro

| CODE | Description | Weight [kg] |
|-----------|-------------------------------|-------------|
| 183015001 | Inoxpres slip coupling Ø 15 | 0,056 |
| 183018001 | Inoxpres slip coupling Ø 18 | 0,066 |
| 183022001 | Inoxpres slip coupling Ø 22 | 0,083 |
| 183028001 | Inoxpres slip coupling Ø 28 | 0,114 |
| 183035001 | Inoxpres slip coupling Ø 35 | 0,153 |
| 183042001 | Inoxpres slip coupling Ø 42 | 0,217 |
| 183054001 | Inoxpres slip coupling Ø 54 | 0,321 |
| 183076001 | Inoxpres slip coupling Ø 76,1 | 0,94 |
| 183088001 | Inoxpres slip coupling Ø 88,9 | 1,24 |
| 183108001 | Inoxpres slip coupling Ø 108 | 1,835 |

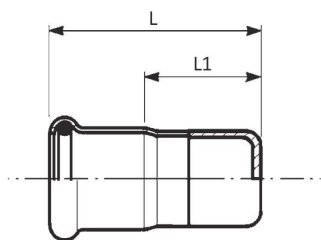

183/003

TAPPO DI CHIUSURA

- STOP END
- VERSCHLUSSKAPPE
- BOUCHON D'OBTURATION
- TAPÓN

MATERIAL: AISI 316L - 1.4404
O-RING: EPDM nero - black - Schwarz - noir - negro

| CODE | Description | Weight [kg] |
|-----------|---------------------------|-------------|
| 183015003 | Inoxpres stop end Ø 15 | 0,026 |
| 183018003 | Inoxpres stop end Ø 18 | 0,032 |
| 183022003 | Inoxpres stop end Ø 22 | 0,043 |
| 183028003 | Inoxpres stop end Ø 28 | 0,061 |
| 183035003 | Inoxpres stop end Ø 35 | 0,095 |
| 183042003 | Inoxpres stop end Ø 42 | 0,126 |
| 183054003 | Inoxpres stop end Ø 54 | 0,185 |
| 183076003 | Inoxpres stop end Ø 76,1 | 0,54 |
| 183088003 | Inoxpres stop end Ø 88,9 | 0,63 |
| 183108003 | Inoxpres stop end Ø 108 | 0,935 |
| 183139003 | Inoxpres stop end Ø 139,7 | 1,38 |
| 183168003 | Inoxpres stop end Ø 168,3 | 2,038 |

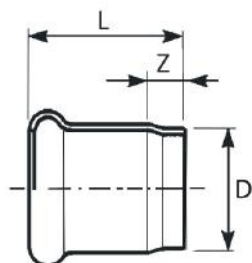

187/R

MEZZO MANICOTTO A SALDARE

- HALF WELDING COUPLING
- HALBE LAENGE SCHWEISSMUFFE
- DEMI MANCHON À SOUDER
- MEDIO MANGUITO PARA SOLDAR

MATERIAL: AISI 316L - 1.4404
O-RING: assente - absent - Abwesend - absent - ausente

| CODE | Description | Weight [kg] |
|------------|---|-------------|
| 187015000R | Inoxpres half coupling - annea. Ø 15 | 0,02 |
| 187018000R | Inoxpres half coupling - annea. Ø 18 | 0,024 |
| 187022000R | Inoxpres half coupling - annea. Ø 22 | 0,03 |
| 187028000R | Inoxpres half coupling - annea. Ø 28 | 0,04 |
| 187035000R | Inoxpres half coupling - annea. Ø 35 | 0,052 |
| 187042000R | Inoxpres half coupling - annea. Ø 42 | 0,074 |
| 187054000R | Inoxpres half coupling - annea. Ø 54 | 0,104 |
| 187076000R | Inoxpres half coupling - annea. Ø 76,1 | 0,308 |
| 187088000R | Inoxpres half coupling - annea. Ø 88,9 | 0,404 |
| 187108000R | Inoxpres half coupling - annea. Ø 108 | 0,614 |
| 187139000R | Inoxpres half coupling - annea. Ø 139,7 | 0,986 |
| 187168000R | Inoxpres half coupling - annea. Ø 168,3 | 1,449 |

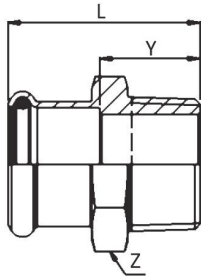

187

MANICOTTO MISTO FILETTO M

- MALE ADAPTER
- ÜBERGANGSSTÜCK MIT AG
- RACCORD AVEC FILETAGE MALE
- UNIÓN MACHO

MATERIAL: AISI 316L - 1.4404

O-RING: EPDM nero - black - Schwarz - noir - negro

THREAD: EN 10226-1 (ex ISO 7/1)

| CODE | Description | Weight [kg] |
|-------------|----------------------------------|-------------|
| 187308015 | Inoxpres adap. male 3/8"x15 | 0,046 |
| 187102015 | Inoxpres adap. male 1/2"x15 | 0,054 |
| 187304015 | Inoxpres adap. male 3/4"x15 | 0,101 |
| 187102018 | Inoxpres adap. male 1/2"x18 | 0,058 |
| 187304018 | Inoxpres adap. male 3/4"x18 | 0,094 |
| 187102022 | Inoxpres adap. male 1/2"x22 | 0,083 |
| 187304022 | Inoxpres adap. male 3/4"x22 | 0,089 |
| 187100022 | Inoxpres adap. male 1"x22 | 0,154 |
| 187102028 | Inoxpres adap. male 1/2"x28 | 0,121 |
| 187304028 | Inoxpres adap. male 3/4"x28 | 0,114 |
| 187100028 | Inoxpres adap. male 1"x28 | 0,123 |
| 187114028 | Inoxpres adap. male 1"1/4x28 | 0,274 |
| 187100035 | Inoxpres adap. male 1"x35 | 0,173 |
| 187114035 | Inoxpres adap. male 1"1/4x35 | 0,18 |
| 187112035 | Inoxpres adap. male 1"1/2x35 | 0,278 |
| 187114042 | Inoxpres adap. male 1"1/4x42 | 0,24 |
| 187112042 | Inoxpres adap. male 1"1/2x42 | 0,236 |
| 187112054 | Inoxpres adap. male 1"1/2x54 | 0,356 |
| 187200054 | Inoxpres adap. male 2"x54 | 0,362 |
| 187212076 | Inoxpres adap. male 2"1/2x 76,1 | 0,769 |
| 187300088 | Inoxpres adap. male 3"x88,9 | 1,218 |
| 187400108 | Inoxpres adap. male 4"x108 | 1,842 |
| 18730815NPT | Inoxpres adap. male NPT 3/8"x15 | 0,046 |
| 18710215NPT | Inoxpres adap. male NPT 1/2"x15 | 0,06 |
| 18710218NPT | Inoxpres adap. male NPT 1/2"x18 | 0,063 |
| 18730422NPT | Inoxpres adap. male NPT 3/4"x22 | 0,093 |
| 18710028NPT | Inoxpres adap. male NPT 1"x28 | 0,133 |
| 18711435NPT | Inoxpres adap. male NPT 1"1/4x35 | 0,205 |
| 18711242NPT | Inoxpres adap. male NPT 1"1/2x42 | 0,268 |
| 18720054NPT | Inoxpres adap. male NPT 2"x54 | 0,405 |
| 190102015 | Inoxpres adap. female 1/2"x15 | 0,064 |
| 190304015 | Inoxpres adap. female 3/4"x15 | 0,075 |
| 190102018 | Inoxpres adap. female 1/2"x18 | 0,089 |
| 190304018 | Inoxpres adap. female 3/4"x18 | 0,08 |
| 190102022 | Inoxpres adap. female 1/2"x22 | 0,099 |
| 190304022 | Inoxpres adap. female 3/4"x22 | 0,082 |
| 190100022 | Inoxpres adap. female 1"x22 | 0,148 |
| 190102028 | Inoxpres adap. female 1/2"x28 | 0,161 |
| 190304028 | Inoxpres adap. female 3/4"x28 | 0,13 |
| 190100028 | Inoxpres adap. female 1"x28 | 0,158 |

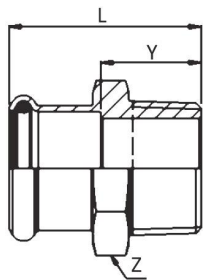

187

MANICOTTO MISTO FILETTO M

- MALE ADAPTER
- ÜBERGANGSSTÜCK MIT AG
- RACCORD AVEC FILETAGE MALE
- UNIÓN MACHO

MATERIAL: AISI 316L - 1.4404

O-RING: EPDM nero - black - Schwarz - noir - negro

THREAD: EN 10226-1 (ex ISO 7/1)

| CODE | Description | Weight [kg] |
|-------------|------------------------------------|-------------|
| 190114028 | Inoxpres adap. female 1"1/4x28 | 0,148 |
| 190100035 | Inoxpres adap. female 1"x35 | 0,216 |
| 190114035 | Inoxpres adap. female 1"1/4x35 | 0,17 |
| 190112035 | Inoxpres adap. female 1"1/2x35 | 0,284 |
| 190114042 | Inoxpres adap. female 1"1/4x42 | 0,259 |
| 190112042 | Inoxpres adap. female 1"1/2x42 | 0,243 |
| 190112054 | Inoxpres adap. female 1"1/2x54 | 0,42 |
| 190200054 | Inoxpres adap. female 2"x54 | 0,314 |
| 19010215NPT | Inoxpres adap. female NPT 1/2"x15 | 0,068 |
| 19010218NPT | Inoxpres adap. female NPT 1/2"x18 | 0,071 |
| 19030422NPT | Inoxpres adap. female NPT 3/4"x22 | 0,092 |
| 19010028NPT | Inoxpres adap. female NPT 1"x28 | 0,185 |
| 19011435NPT | Inoxpres adap. female NPT 1"1/4x35 | 0,181 |
| 19011242NPT | Inoxpres adap. female NPT 1"1/2x42 | 0,276 |
| 19020054NPT | Inoxpres adap. female NPT 2"x54 | 0,388 |



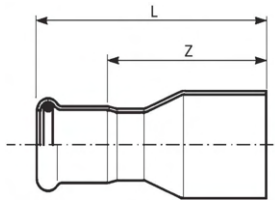

191

RIDUZIONE MF

- REDUCER
- REDUZIERSTÜCK
- REDUCTION
- REDUCCIÓN MH

MATERIAL: AISI 316L - 1.4404

O-RING: EPDM nero - black - Schwarz - noir - negro

| CODE | Description | Weight [kg] |
|-----------|------------------------------|-------------|
| 191018015 | Inoxpres reducer 18x15 | 0,035 |
| 191022015 | Inoxpres reducer 22x15 | 0,043 |
| 191022018 | Inoxpres reducer 22x18 | 0,047 |
| 191028015 | Inoxpres reducer 28x15 | 0,05 |
| 191028018 | Inoxpres reducer 28x18 | 0,063 |
| 191028022 | Inoxpres reducer 28x22 | 0,066 |
| 191035015 | Inoxpres reducer 35x15 | 0,089 |
| 191035018 | Inoxpres reducer 35x18 | 0,087 |
| 191035022 | Inoxpres reducer 35x22 | 0,09 |
| 191035028 | Inoxpres reducer 35x28 | 0,098 |
| 191042015 | Inoxpres reducer 42x15 | 0,111 |
| 191042018 | Inoxpres reducer 42x18 | 0,114 |
| 191042022 | Inoxpres reducer 42x22 | 0,12 |
| 191042028 | Inoxpres reducer 42x28 | 0,13 |
| 191042035 | Inoxpres reducer 42x35 | 0,138 |
| 191054015 | Inoxpres reducer 54x15 | 0,158 |
| 191054018 | Inoxpres reducer 54x18 | 0,162 |
| 191054022 | Inoxpres reducer 54x22 | 0,169 |
| 191054028 | Inoxpres reducer 54x28 | 0,18 |
| 191054035 | Inoxpres reducer 54x35 | 0,193 |
| 191054042 | Inoxpres reducer 54x42 | 0,21 |
| 191076042 | Inoxpres reducer 76,1x42 | 0,471 |
| 191076054 | Inoxpres reducer 76,1x54 | 0,529 |
| 191088054 | Inoxpres reducer 88,9x54 | 0,683 |
| 191088076 | Inoxpres reducer 88,9x76,1 | 0,813 |
| 191108054 | Inoxpres reducer 108x54 | 0,831 |
| 191108076 | Inoxpres reducer 108x76,1 | 1,022 |
| 191108088 | Inoxpres reducer 108x88,9 | 1,107 |
| 191139076 | Inoxpres reducer 139,7x76,1 | 2,1 |
| 191139088 | Inoxpres reducer 139,7x88,9 | 2,319 |
| 191139108 | Inoxpres reducer 139,7x108 | 2,285 |
| 191168076 | Inoxpres reducer 168,3x76,1 | 2,515 |
| 191168088 | Inoxpres reducer 168,3x88,9 | 2,66 |
| 191168108 | Inoxpres reducer 168,3x108 | 2,945 |
| 191168139 | Inoxpres reducer 168,3x139,7 | 3,392 |

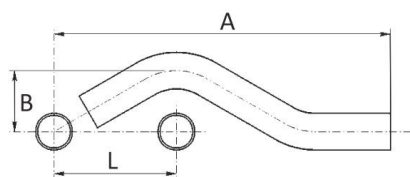

179

"S" DI SCAVALCAMENTO MM

- PIPE BRIDGE
- SPRUNGBOGEN
- "S" DE CHEVAUCHEMENT MALE
- "S" DE SUPERPOSICIÓN MM

MATERIAL: AISI 316L - 1.4404

| CODE | Description | Weight [kg] |
|-----------|---------------------------|-------------|
| 179015000 | Inoxpres pipe bridge Ø 15 | 0,054 |
| 179018000 | Inoxpres pipe bridge Ø 18 | 0,074 |
| 179022000 | Inoxpres pipe bridge Ø 22 | 0,116 |
| 179028000 | Inoxpres pipe bridge Ø 28 | 0,192 |

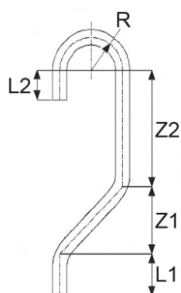

178

TUBO PER ARIA COMPRESSA

- PIPE FOR COMPRESSED AIR
- SPRUNGBOGEN FÜR DRUCKLUFT
- TUBE POUR L'AIR COMPRIMÉ
- TUBO DE AIRE

MATERIAL: AISI 316L - 1.4404

| CODE | Description | Weight [kg] |
|-----------|---------------------------------|-------------|
| 178015316 | Inoxpres compres. air pipe Ø 15 | 0,143 |
| 178018316 | Inoxpres compres. air pipe Ø 18 | 0,195 |
| 178022316 | Inoxpres compres. air pipe Ø 22 | 0,359 |
| 178028316 | Inoxpres compres. air pipe Ø 28 | 0,55 |



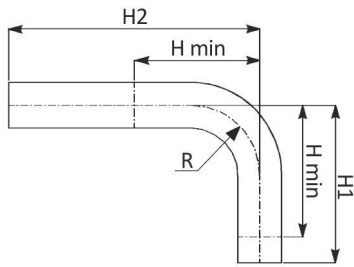

194/900

TUBO CURVO 90°

- 90° ELBOW MM
- PASSBOGEN 90°
- COUDE D'AJUSTEMENT 90°
- TUBO RICURVO 90° MM

MATERIAL: AISI 316L - 1.4404

| CODE | Description | Weight [kg] |
|-----------|---------------------------|-------------|
| 194015900 | Inoxpres elbow 90° Ø 15 | 0,089 |
| 194018900 | Inoxpres elbow 90° Ø 18 | 0,108 |
| 194022900 | Inoxpres elbow 90° Ø 22 | 0,133 |
| 194028900 | Inoxpres elbow 90° Ø 28 | 0,202 |
| 194035900 | Inoxpres elbow 90° Ø 35 | 0,38 |
| 194042900 | Inoxpres elbow 90° Ø 42 | 0,592 |
| 194054900 | Inoxpres elbow 90° Ø 54 | 1,139 |
| 194028600 | Inoxpres elbow 60° Ø 28 | 0,182 |
| 194035600 | Inoxpres elbow 60° Ø 35 | 0,406 |
| 194042600 | Inoxpres elbow 60° Ø 42 | 0,563 |
| 194054600 | Inoxpres elbow 60° Ø 54 | 0,914 |
| 194018300 | Inoxpres elbow 30° Ø 18 | 0,113 |
| 194022300 | Inoxpres elbow 30° Ø 22 | 0,134 |
| 194028300 | Inoxpres elbow 30° Ø 28 | 0,183 |
| 194035300 | Inoxpres elbow 30° Ø 35 | 0,375 |
| 194042300 | Inoxpres elbow 30° Ø 42 | 0,566 |
| 194054300 | Inoxpres elbow 30° Ø 54 | 0,909 |
| 194076300 | Inoxpres elbow 30° Ø 76,1 | 1,489 |
| 194088300 | Inoxpres elbow 30° Ø 88,9 | 2,095 |
| 194108300 | Inoxpres elbow 30° Ø 108 | 2,787 |
| 194018150 | Inoxpres elbow 15° Ø 18 | 0,114 |
| 194028150 | Inoxpres elbow 15° Ø 28 | 0,18 |
| 194035150 | Inoxpres elbow 15° Ø 35 | 0,373 |
| 194042150 | Inoxpres elbow 15° Ø 42 | 0,563 |
| 194054150 | Inoxpres elbow 15° Ø 54 | 0,896 |
| 194076150 | Inoxpres elbow 15° Ø 76,1 | 1,694 |
| 194088150 | Inoxpres elbow 15° Ø 88,9 | 2,091 |
| 194108150 | Inoxpres elbow 15° Ø 108 | 2,646 |

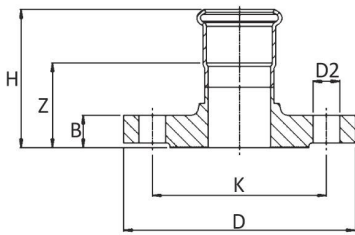

PN 6

193/002

MANICOTTO FLANGIATO

- ADAPTOR FLANGE
- ÜBERGANGSFLANSCH
- BRIDE DE RACCORDEMENT
- BRIDA ADAPTADOR

MATERIAL: AISI 316L – 1.4404

O-RING: EPDM nero - black - Schwarz - noir - negro

| CODE | Description | Weight [kg] |
|-----------|--------------------------------------|-------------|
| 193015002 | Inoxpres adaptor flange Ø 15 PN6 | 0,405 |
| 193018002 | Inoxpres adaptor flange Ø 18 PN6 | 0,405 |
| 193022002 | Inoxpres adaptor flange Ø 22 PN6 | 0,61 |
| 193028002 | Inoxpres adaptor flange Ø 28 PN6 | 0,755 |
| 193035002 | Inoxpres adaptor flange Ø 35 PN6 | 1,08 |
| 193042002 | Inoxpres adaptor flange Ø 42 PN6 | 1,186 |
| 193054002 | Inoxpres adaptor flange Ø 54 PN6 | 1,348 |
| 193076002 | Inoxpres adaptor flange Ø 76,1 PN6 | 1,87 |
| 193088002 | Inoxpres adaptor flange Ø 88,9 PN6 | 2,92 |
| 193108002 | Inoxpres adaptor flange Ø 108 PN6 | 3,525 |
| 193015000 | Inoxpres adaptor flange Ø 15 PN16 | 0,66 |
| 193018000 | Inoxpres adaptor flange Ø 18 PN16 | 0,66 |
| 193022000 | Inoxpres adaptor flange Ø 22 PN16 | 0,945 |
| 193028000 | Inoxpres adaptor flange Ø 28 PN16 | 1,14 |
| 193035000 | Inoxpres adaptor flange Ø 35 PN16 | 1,64 |
| 193042000 | Inoxpres adaptor flange Ø 42 PN16 | 1,8 |
| 193054000 | Inoxpres adaptor flange Ø 54 PN16 | 2,45 |
| 193076000 | Inoxpres adaptor flange Ø 76,1 PN16 | 3,184 |
| 193088000 | Inoxpres adaptor flange Ø 88,9 PN16 | 3,95 |
| 193108000 | Inoxpres adaptor flange Ø 108 PN16 | 4,729 |
| 193139000 | Inoxpres adaptor flange Ø 139,7 PN16 | 7,095 |
| 193168000 | Inoxpres adaptor flange Ø 168,3 PN16 | 8,929 |

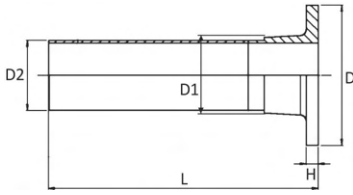

193/004

BOCCHELLO PER FLANGIA LIBERA

- COLLAR FOR LOOSE FLANGE
- AUSSEN FÜR LOSE-FLANSCH
- SORTIE A BRIDE POUR BRIDE TOURNANTE
- TRONCO EMBRIDADO PARA BRIDA LOCA

MATERIAL: AISI 316L - 1.4404

PN 6

| CODE | Description | Weight [kg] |
|-----------|--|-------------|
| 193022004 | Inoxpres collar x loose flg. Ø 22 PN6 | 0,21 |
| 193028004 | Inoxpres collar x loose flg. Ø 28 PN6 | 0,26 |
| 193035004 | Inoxpres collar x loose flg. Ø 35 PN6 | 0,35 |
| 193042004 | Inoxpres collar x loose flg. Ø 42 PN6 | 0,42 |
| 193054004 | Inoxpres collar x loose flg. Ø 54 PN6 | 0,58 |
| 193076004 | Inoxpres collar x loose flg. Ø 76,1 PN6 | 0,84 |
| 193088004 | Inoxpres collar x loose flg. Ø 88,9 PN6 | 1,15 |
| 193108004 | Inoxpres collar x loose flg. Ø 108 PN6 | 1,39 |
| 193022003 | Inoxpres collar x loose flg. Ø 22 PN16 | 0,24 |
| 193028003 | Inoxpres collar x loose flg. Ø 28 PN16 | 0,3 |
| 193035003 | Inoxpres collar x loose flg. Ø 35 PN16 | 0,39 |
| 193042003 | Inoxpres collar x loose flg. Ø 42 PN16 | 0,47 |
| 193054003 | Inoxpres collar x loose flg. Ø 54 PN16 | 0,7 |
| 193076003 | Inoxpres collar x loose flg. Ø 76,1 PN16 | 0,98 |
| 193088003 | Inoxpres collar x loose flg. Ø 88,9 PN16 | 1,31 |
| 193108003 | Inoxpres collar x loose flg. Ø 108 PN16 | 1,58 |

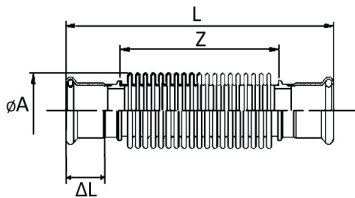

199

COMPENSATORE DI DILATAZIONE

- EXPANSION COMPENSATOR
- WELLENKOMPENSATOR
- COMPENSATEUR D'EXPANSION
- DILATADOR

MATERIAL: AISI 316L - 1.4404

O-RING: EPDM nero - black - Schwarz - noir - negro

| CODE | Description | Weight [kg] |
|-----------|------------------------------------|-------------|
| 199015000 | Inoxpres expan. compensator Ø 15 | 0,08 |
| 199018000 | Inoxpres expan. compensator Ø 18 | 0,108 |
| 199022000 | Inoxpres expan. compensator Ø 22 | 0,13 |
| 199028000 | Inoxpres expan. compensator Ø 28 | 0,155 |
| 199035000 | Inoxpres expan. compensator Ø 35 | 0,251 |
| 199042000 | Inoxpres expan. compensator Ø 42 | 0,44 |
| 199054000 | Inoxpres expan. compensator Ø 54 | 0,55 |
| 199076000 | Inoxpres expan. compensator Ø 76,1 | 1,464 |
| 199088000 | Inoxpres expan. compensator Ø 88,9 | 1,871 |
| 199108000 | Inoxpres expan. compensator Ø 108 | 2,845 |

References

- General Programme Instructions of the International EPD® System. Version 5.0.0;
- PCR 2019:14 – Version 1.3.4 "Construction products";
- Ecoinvent database v.3.10 – March 2024;
- UNI EN ISO 14025: 2010 'Environmental labels and declarations – Type III environmental declarations – Principles and procedures';
- UNI EN ISO 14040: 2021 "Environmental management – Life cycle assessment – Principles and framework";
- UNI EN ISO 14044:2021 'Environmental management – Life cycle assessment – Requirements and guidelines';
- UNI EN ISO 15804:2021 'Sustainability of construction – Environmental product declarations – Development framework rules per product category';
- European Residual Mixes 2023 Association of Issuing Bodies "European Residual Mixes Results of the calculation of Residual Mixes for the calendar year 2023" – version 1.0, 2024-05-30;
- "Metal Recycling Factsheet" – EuRIC AISBL – Recycling: Bridging Circular Economy & Climate Policy – February 2020.





Manufacturing Plant - Pilastro [Mantova]



**Head Office and Manufacturing Plant
Campitello [Mantova]**



RacMet Academy [Mantova]





THE INTERNATIONAL EPD® SYSTEM

