

XUK8TAKSMM12 / XUK8TAKDMM12 Diffuse distance sensor with background suppression

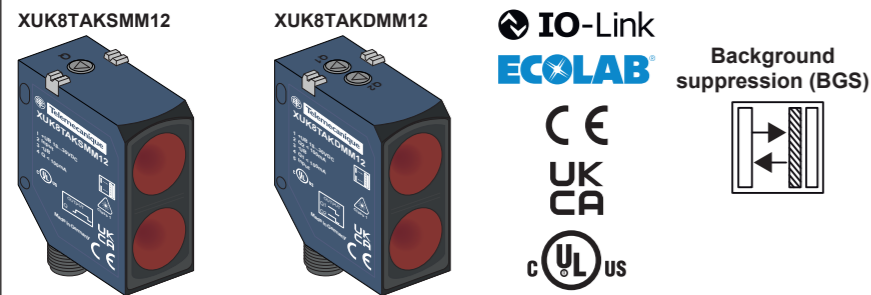

<https://tesensors.com/global/en/document/EAV83774>

Scan the QR-code to access this Instruction Sheet in different languages or you can download it from our website at: www.tesensors.com

We welcome your comments about this document. You can reach us through the customer support page on your local website.

Prevention against other light beams in the colored area

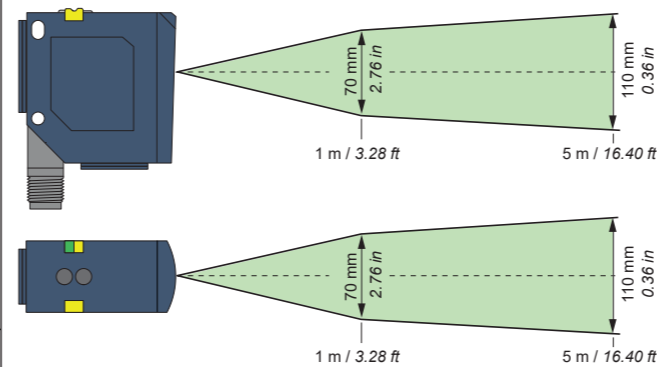

Adjustment

Adjustment of light spot position with optional mounting angle bracket XUZASK004.

Align sensor to the target object. Observe the preferential direction of proximity switches.

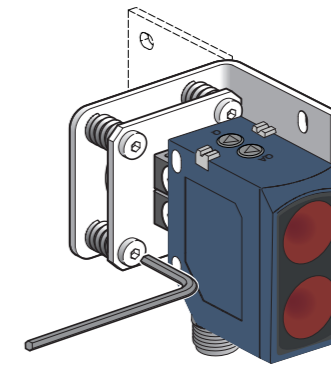

Mounting and Tightening torques

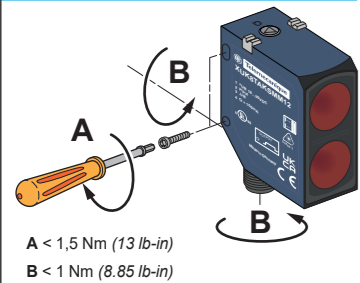

A < 1,5 Nm (13 lb-in)
B < 1 Nm (8.85 lb-in)

LEDs and Setting

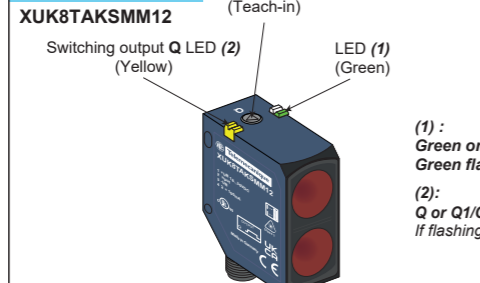

(1):
Green on: Power ON
Green flashes: IO-Link communication

(2):
Q or Q1/Q2: Switching output enabled
If flashing (double flash): contamination

XUK8TAKDMM12

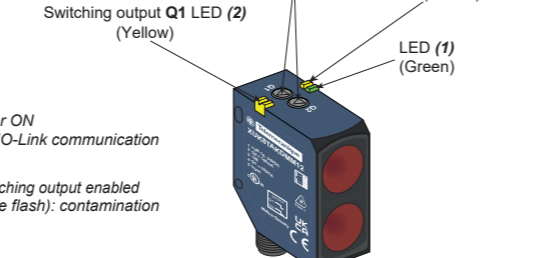

Dimensions

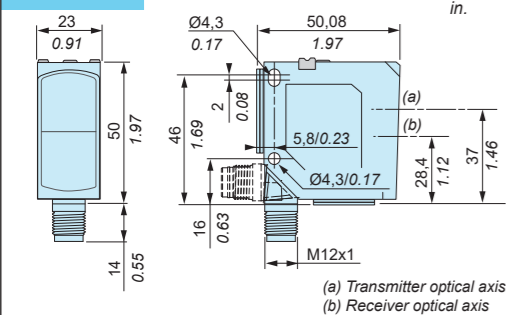

(a) Transmitter optical axis
(b) Receiver optical axis

Wiring diagrams

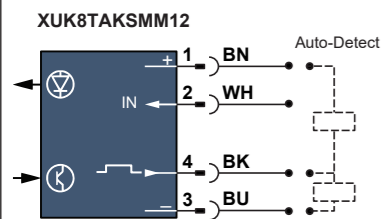

Extension cable reference: XZCPV1141L2 / L5 / L10
In IO-Link mode, a 4-pin cable must be used

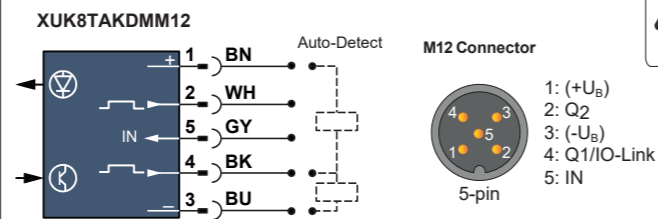

Extension cable reference: XZCPV11V12L2 / L5 / L10
In IO-Link mode, a 4-pin cable must be used

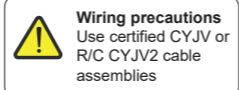

Wiring precautions
Use certified CYJV or R/C CYJV2 cable assemblies

BN: Brown
WH: White
GY: Grey
BK: Black
BU: Blue

Detection curves

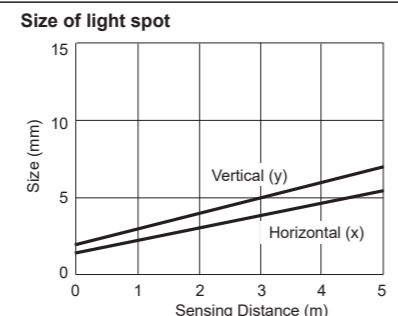
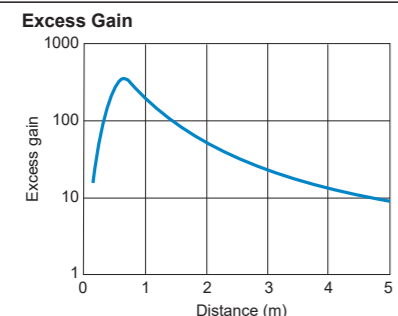

Manufacturer :
Schneider Electric Industries SAS
35 rue Joseph Monier
92500 Rueil Malmaison
France

UK Representative :
Schneider Electric Limited
Stafford Park 5
Telford, TF3 3BL
United Kingdom

Уполномоченный поставщик в Республике Казахстан:
ТОО «Шнейдер Электрик»
Адрес: 050010, РК, г. Алматы, пр. Достык, 38, Бизнес Центр «Кен Дала», 5 этаж.
Тел.: +7 (727) 3 57 23 57
Факс.: +7 (727) 357 24 39

Қазақстан Республикасында ресми жеткізуші:
ЖШС «Шнейдер Электрик»
Мекен-жайы: 050010, Қазақстан Республикасы, Алматы қ., Достық даң. 38, «Кен Дала» Бизнес Орталығы, 5-ші қабат.
Тел.: +7 (727) 357 23 57
Факс.: +7 (727) 357 24 39

Electrical equipment should be installed, operated, serviced, and maintained only by qualified personnel. No responsibility is assumed by Schneider Electric for any consequences arising out of the use of this material.
© 2022 Schneider Electric. "All Rights Reserved."

Characteristics

Certification	CE - UKCA - cULus - Ecolab	
Sensing distance (Reference material)	White (90%)	0...5 m / 0...16.4 ft
	Grey (18%)	0...5 m / 0...16.4 ft
	Black (6%)	0,05...3 m / 0.16...9.84 ft
Setting	Teach button	
Color of detection light beam	Laser class 1, red, 655 nm	
Spot size of the light beam	see "Light beam size" curve	
Wavelength	λ = 655 nm	
	Puls duration t < 5 ns	
	Frequency f = 62,5 kHz	
	Limit of radiant power pulse Pp < 1,25 mW	
Switching output Q	XUK8TAKSMM12	Auto-Detect PNP/NPN (N.O. or N.C.) - IOLINK
	XUK8TAKDMM12	2 x Auto-Detect (Q1, Q2)
Control input IN (switching function Q): see illustration G	XUK8TAKSMM12	+U _B = Teach-in
	XUK8TAKDMM12	+U _B = -
	XUK8TAKSMM12	-U _B = Open = normal function
XUK8TAKDMM12	-U _B = Open = normal function	
Current consumption	≤ 60 mA	
Switching capacity	≤ 100 mA	
Switching frequency	≤ 500 Hz	
First-up delay	300 ms max.	
Response time	1,2 ms max.	
Recovery time	1,2 ms max.	
Ambient Temperature	Operating : - 20...+60 °C (-4...+140 °F) Storage : - 40...+80 °C (-40...+176 °F)	
Power Voltage	Rated operational voltage: 24 Vdc Ripple p-p 10% maximum Operating range: 18...30 Vdc (including ripple)	
Product Protection	Power supply : Reverse polarity protection Output: Short circuit protection	
Protection class		
Degree of protection	IP67 conforming to EN/IEC 60529 IP69K conforming to DIN 40050	
Vibration resistance	Frequency range: 10 Hz to 55 Hz Acceleration: 7 gn	
Shock resistance	Peak acceleration: 10 gn Duration of the pulse: 11 ms	
Material	Housing: ABS/PC, Lens: PMMA	

IO-Link Data sheet and IODD IO-Link on website: <https://tesensors.com/iolink>

WARNING
UNINTENDED EQUIPMENT OPERATION

- Comply with the wiring and configuration instructions.
- Clean the lens regularly, taking care not to scratch it.
- Check the connections and fixings during maintenance operations.

Failure to follow these instructions can result in death, serious injury or equipment damage.

CAUTION
HAZARD OF LASER RADIATION EXPOSURE

- Do not stare into the beam.
- Do not operate below - 20°C (- 4°F)
- Follow all operating instructions.

Failure to follow these instructions can result in injury or equipment damage.

CLASS 1 LASER PRODUCT (IEC 60825-1: 2014)
Complies with 21 CFR 1040.10 and 1040.11 except for deviations pursuant to laser Notice No. 56 dated May, 2019

Accessories

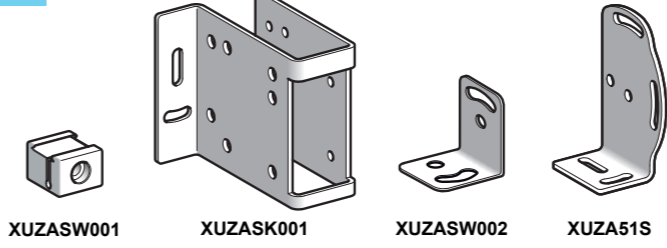

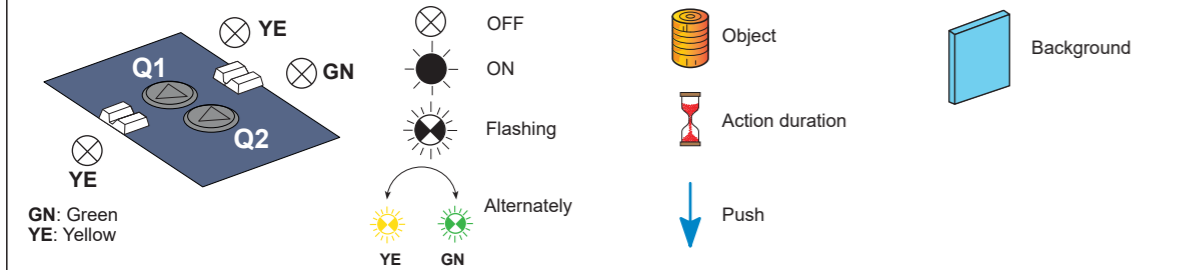

Setting
The sensor has 3 different Teach-in modes. The variant XUK8TAKDMM12 has two switching outputs which can be set independently of one another.

Standard Teach-in (STI): is suited for nearly all applications. Setting is made on object and background (see Chapter B).

Object-Object Teach-in (OTI): is suited for applications where the background cannot be taught in. Setting is made 2x on the object (see Chapter C).

Dynamic Teach-in (DTI): is suited for setting the sensor in the running process (see Chapter D).

Overview

Function	Action Step 1 (1)	External teach	See illustration
Switching output 1	press Q ₁ > 3 s	connect IN > 3 s	B / C / D
Switching output 2 (2)	press Q ₂ > 3 s	connect IN > 6 s	B / C / D
N.O. / N.C. / Antivalent (NO + NC)	press Q > 10 s	connect IN > 10 s	E
Auto-Detect / NPN / PNP	press Q > 13 s	connect IN > 13 s	F

(1) Step 2: press Q₁ (or Q₂) / connect IN > 1 s
(2) All XUK8TAKMM12

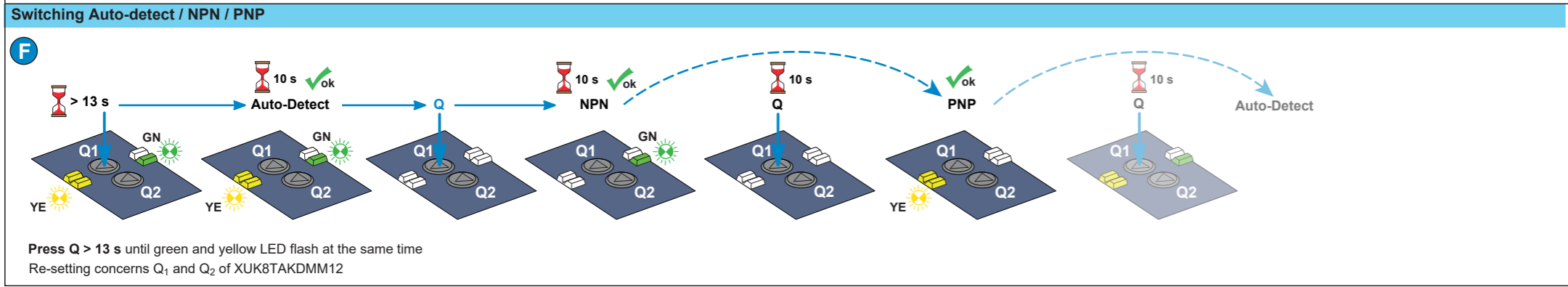
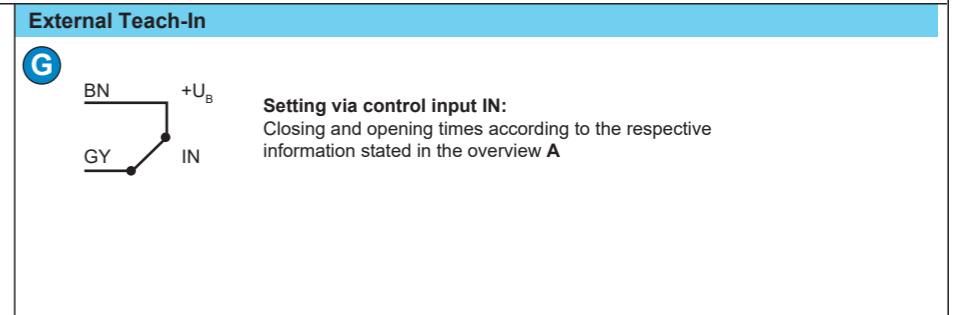
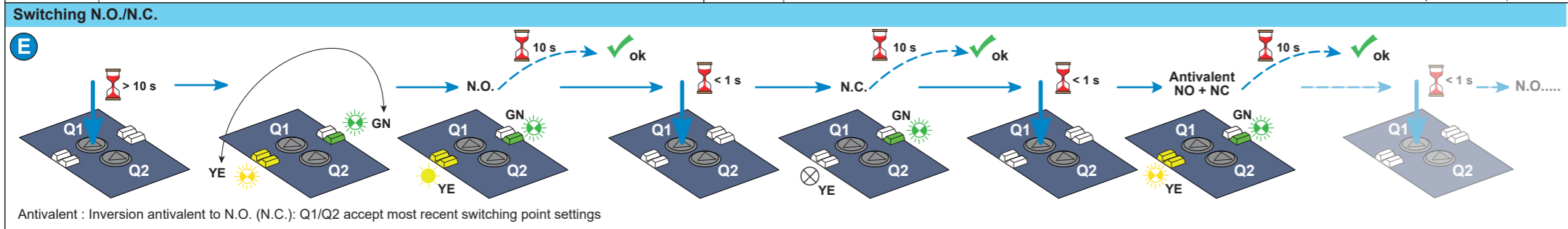
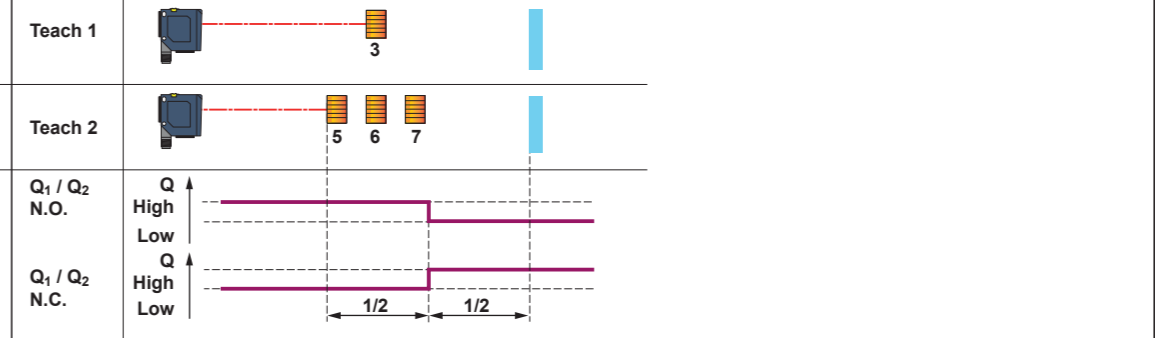
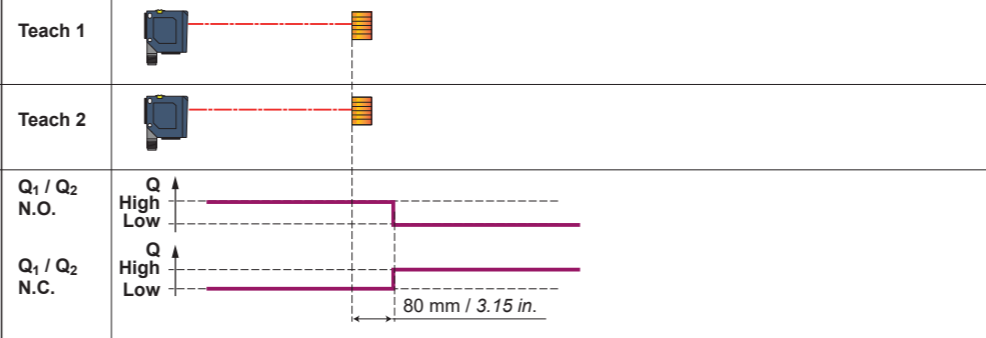
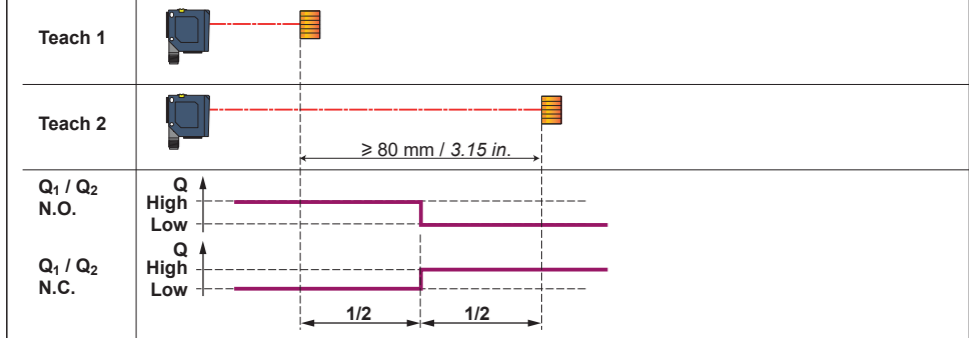
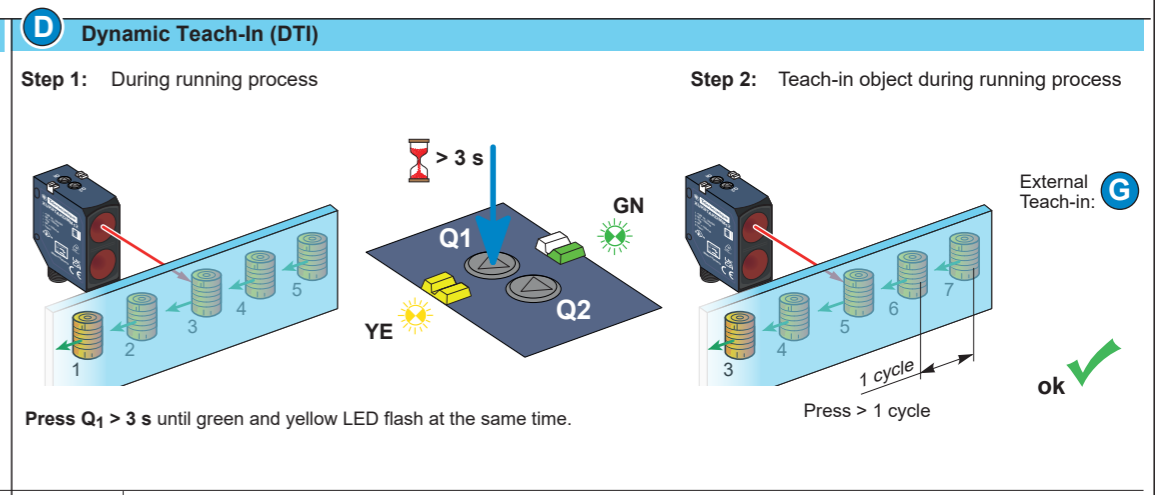
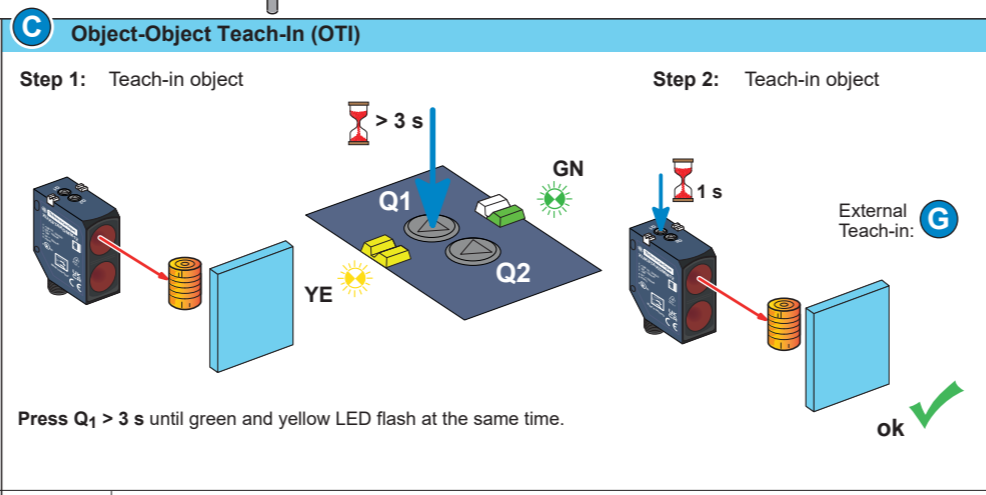
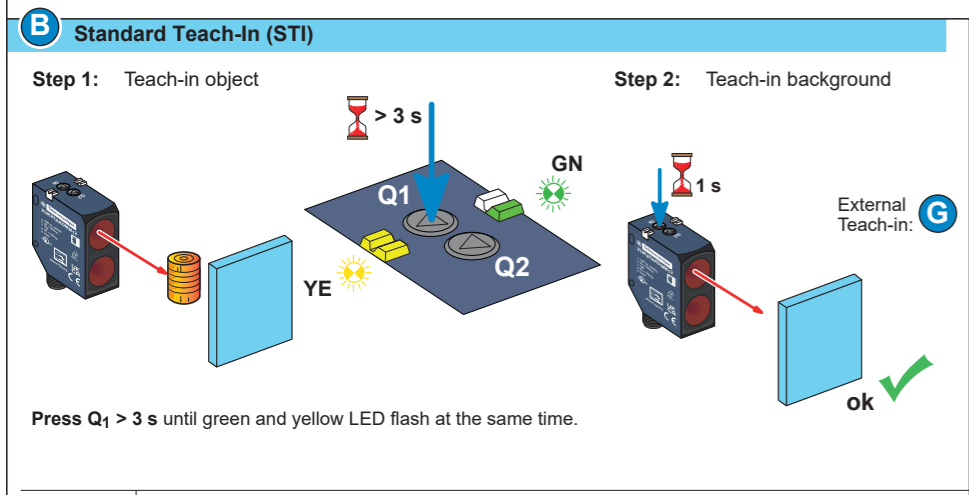
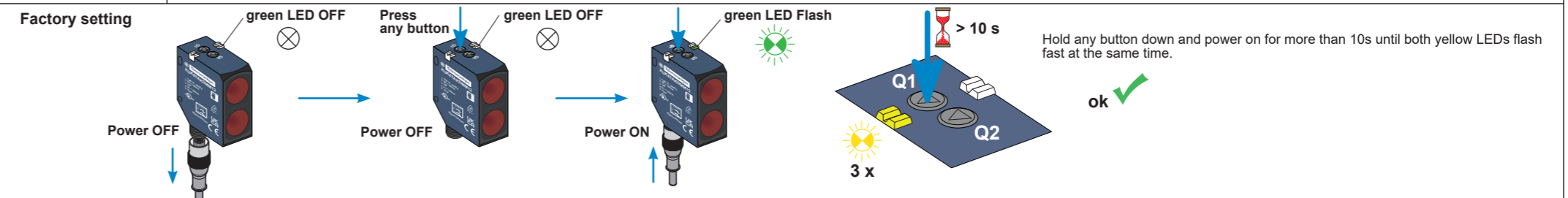

XUK8TAKSMM12 / XUK8TAKDMM12 Capteur de distance diffus avec suppression d'arrière-plan

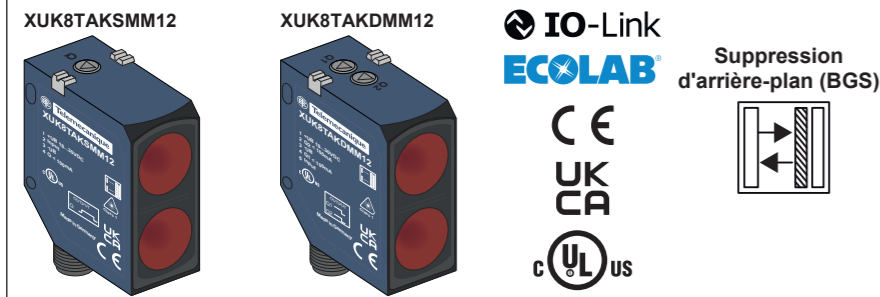

<https://tesensors.com/global/en/document/EAV83774>

Scannez le code Qr pour accéder à cette instruction de service en différentes langues ou vous pouvez la télécharger sur notre site Web à l'adresse : www.tesensors.com

Vos commentaires sur ce document sont les bienvenus. Vous pouvez nous joindre via la page de support client sur votre site Web local.

Prévention contre d'autres faisceaux lumineux dans la zone colorée

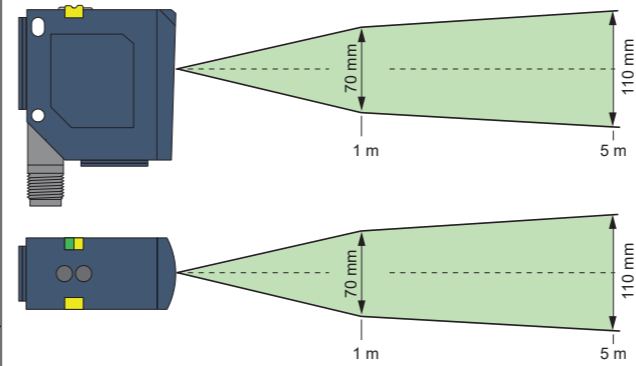

Ajustement

Réglage de la position du spot lumineux par l'équerre de montage XUZASK004 qui est disponible en option.

Aligner le capteur sur l'objet à détecter. Observer la direction préférentielle des capteurs optiques de proximité.

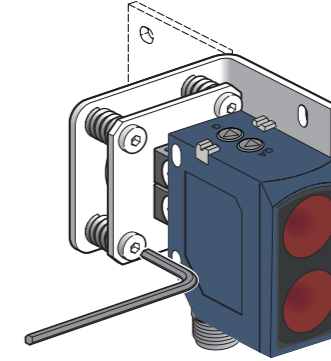

Montage et couples de serrage

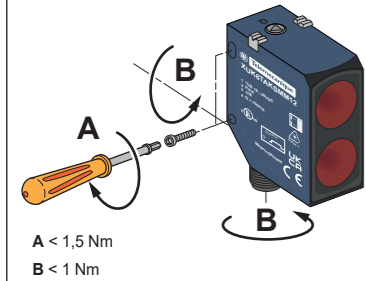

DELs et réglages

XUK8TAKSMM12

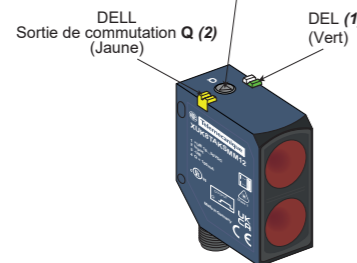

(1) : Vert allumé : sous tension
Vert clignotant : communication IO-Link

(2) : Q ou Q1/Q2: Sortie de commutation activée
Si clignotant (double clignotement) : pollution

XUK8TAKDMM12

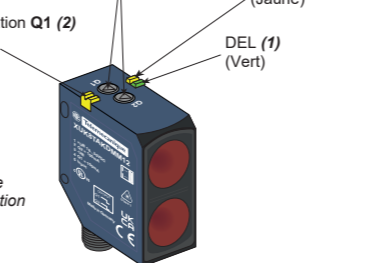

Dimensions

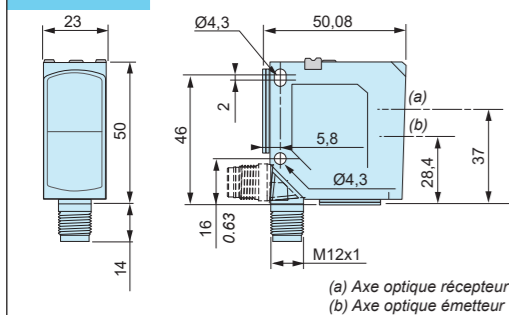

Schémas de câblage

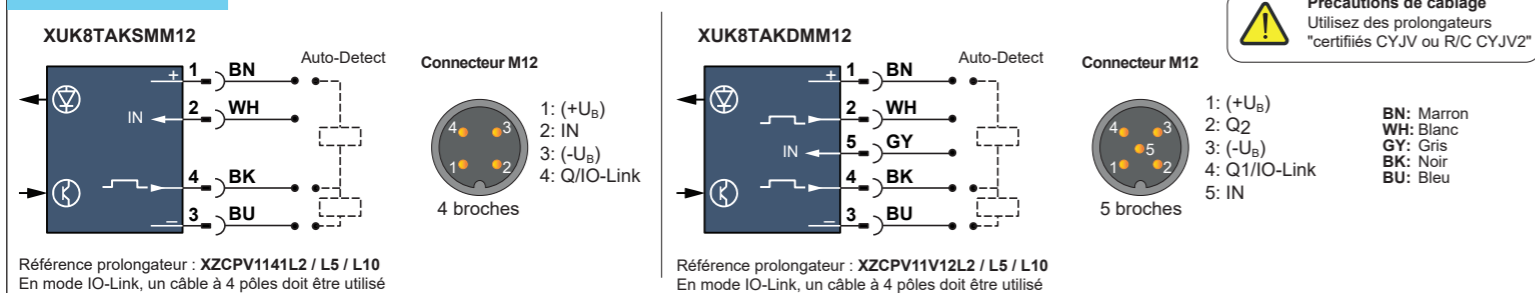

Référence prolongateur : XZCPV1141L2 / L5 / L10

En mode IO-Link, un câble à 4 pôles doit être utilisé

Référence prolongateur : XZCPV11V12L2 / L5 / L10

En mode IO-Link, un câble à 4 pôles doit être utilisé

Courbes de détection

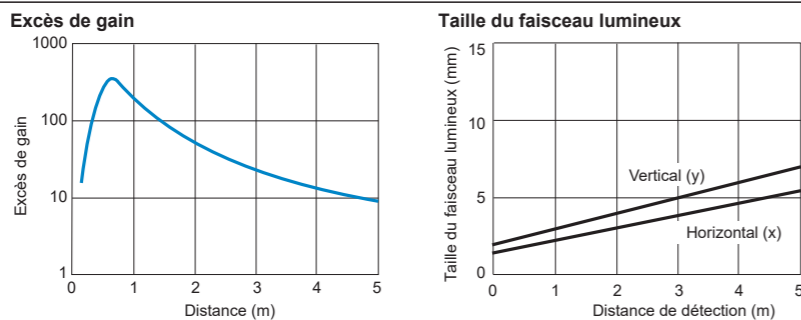

Caractéristiques

Certification	CE - UKCA - cULus - Ecolab	
Distance de détection (Matériel de référence)	Blanc (90%)	0...5 m
	Gris (18%)	0...5 m
	Noir (6%)	0,05...3 m
Réglage	Bouton poussoir (Teach-in)	
Couleur du faisceau lumineux de détection	Laser classe 1, rouge, 655 nm	
Taille du spot du faisceau lumineux	voir la courbe "Taille du faisceau lumineux"	
Longueur d'onde	$\lambda = 655 \text{ nm}$	
	Largeur d'impulsion $t < 5 \text{ ns}$	
	Fréquence $f = 62,5 \text{ kHz}$	
	Puissance rayonnée valeur limite impulsion $Pp < 1,25 \text{ mW}$	
Sortie de commutation Q	XUK8TAKSMM12	1 x Auto-Detect (Q)
	XUK8TAKDMM12	2 x Auto-Detect (Q1, Q2)
Entrée de contrôle IN (fonction de commutation Q): voir illustration G	XUK8TAKSMM12	+U _B = Teach-in -U _B = Ouvert = fonction normale
	XUK8TAKDMM12	+U _B = - -U _B = Ouvert = fonction normale
		= bouton verrouillé
Consommation de courant	≤ 60 mA	
Capacité de commutation	≤ 100 mA	
Fréquence de commutation	≤ 500 Hz	
Délai de disponibilité	300 ms max.	
Temps de réponse	1,2 ms max.	
Temps de relâchement	1,2 ms max.	
Température ambiante	En fonctionnement : - 20...+60 °C Stockage : - 40...+80 °C	
Tension d'alimentation	Tension assignée d'emploi: 24 Vdc Ondulation p-p 10% max. Plage de fonctionnement: 18...30 Vdc (y compris l'ondulation)	
Protection du produit	Alimentation: Protection contre l'inversion de polarité Sortie : Protection contre les courts-circuits	
Classe de protection		
Degré de protection	IP67 conforme à EN/IEC 60529 IP69K conforme à DIN 40050	
Résistance aux vibrations	Plage de fréquences : 10 Hz to 55 Hz Accélération : 7 gn	
Résistance au choc	Pic d'accélération : 10 gn Durée de l'impulsion : 11 ms	
Matériaux	Boîtier : ABS/PC, Lentille: PMMA	

IO-Link Data sheet and IODD IO-Link on website: <https://tesensors.com/iolink>

AVERTISSEMENT
FUNCTIONNEMENT INATTENDU DE L'EQUIPEMENT
 • Respecter les instructions de câblage et de réglage
 • Nettoyer la lentille régulièrement sans la rayer.
 • Vérifier les connexions et les fixations lors des opérations de maintenance.
Le non-respect de ces instructions peut provoquer la mort, des blessures graves ou des dommages matériels.

ATTENTION
RISQUE D'EXPOSITION A UN RAYONNEMENT LASER
 • Ne pas regarder dans la trajectoire du rayon laser.
 • Ne pas utiliser en dessous de - 20 °C
 • Respectez toutes les instructions d'utilisation.
Le non-respect de ces instructions peut provoquer des blessures ou des dommages matériels.

APPAREIL A LASER DE CLASSE 1 (DIN EN 60825-1)
 Correspond à 21 CFR 1040.10 et 1040.11 à l'exception des différences conformément à la notice du laser n° 50 du 24 juin 2007

Manufacturer :
 Schneider Electric Industries SAS
 35 rue Joseph Monier
 92500 Rueil Malmaison
 France

UK Representative :
 Schneider Electric Limited
 Stafford Park 5
 Telford, TF3 3BL
 United Kingdom

Уполномоченный поставщик в Республике Казахстан:
 ТОО «Шнейдер Электрик»
 Адрес: 050010, РК, г. Алматы, пр. Достык, 38, Бизнес Центр «Кен Дала», 5 этаж.
 Тел.: +7 (727) 3 57 23 57
 Факс.: +7 (727) 357 24 39

Қазақстан Республикасында ресми жеткізуші:
 ЖШС «Шнейдер Электрик»
 Мекен-жайы: 050010, Қазақстан Республикасы, Алматы қ., Достық даң. 38, «Кен Дала» Бизнес Орталығы, 5-ші қабат.
 Тел.: +7 (727) 357 23 57
 Факс.: +7 (727) 357 24 39

Accessoires

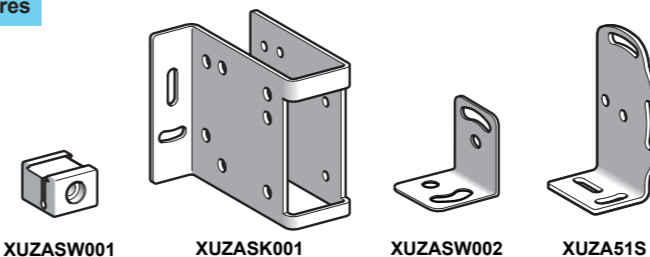

L'installation, l'utilisation, la réparation et la maintenance des équipements électriques doivent être assurées exclusivement par du personnel qualifié. Schneider Electric décline toute responsabilité quant aux conséquences de l'utilisation de ce matériel.

© 2022 Schneider Electric. "All Rights Reserved."

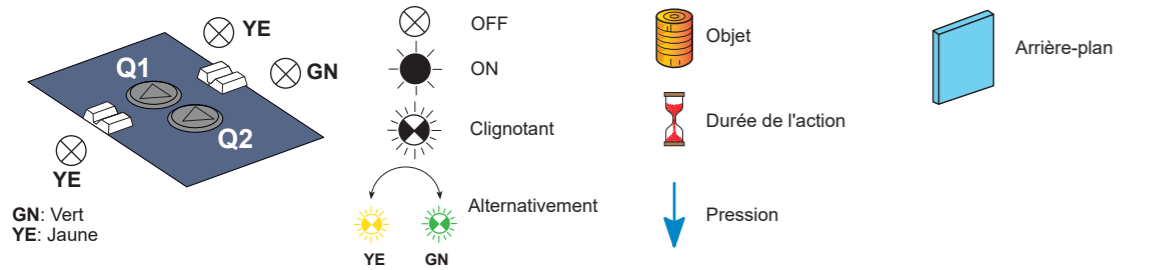

Réglage
 Le capteur a 3 modes différents d'apprentissage (Teach-in). La variante XUK8TAKDMM12 a deux sorties de commutation réglables indépendamment l'une de l'autre.
Standard Teach-in (STI): est adapté à presque toutes les applications. Apprentissage sur l'objet puis sur l'arrière plan (voir chapitre B).
Object-Object Teach-in (OTI): est approprié pour les applications où l'arrière-plan ne peut être appris. Le réglage est fait 2x sur l'objet (voir chapitre C).
Dynamic Teach-in (DTI): est approprié pour régler le capteur pendant qu'il est en service (voir chapitre D).

Aperçu

Fonction	Action Étape 1 (1)	Teach-in externe	Voir illustration
Sortie de commutation 1	appuyez Q ₁ > 3 s	connectez IN > 3 s	B / C / D
Sortie de commutation2 (2)	appuyez Q ₂ > 3 s	connectez IN > 6 s	B / C / D
N.O. / N.F. / Antivalent (NO + NF)	appuyez Q > 10 s	connectez IN > 10 s	E
Auto-Detect / NPN / PNP	appuyez Q > 13 s	connectez IN > 13 s	F

(1) Étape 2 : appuyer sur Q1 (ou Q2) / connectez IN > 1 s
 (2) Tous les XUK8TAKMM12

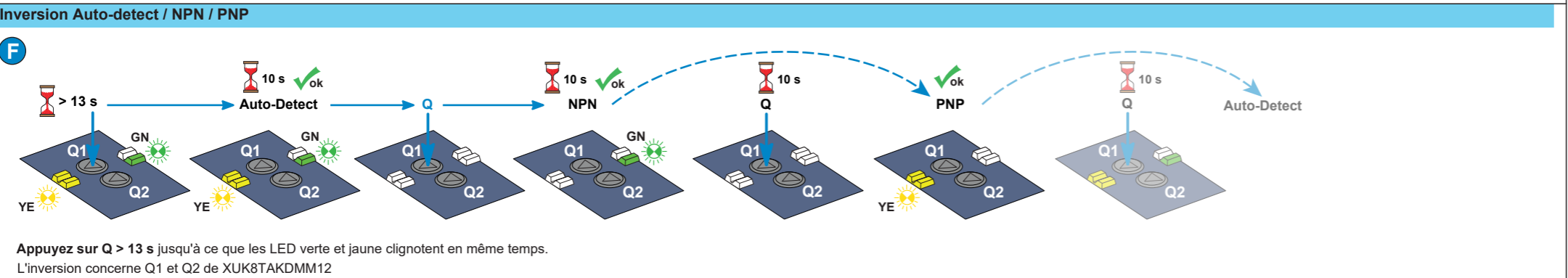
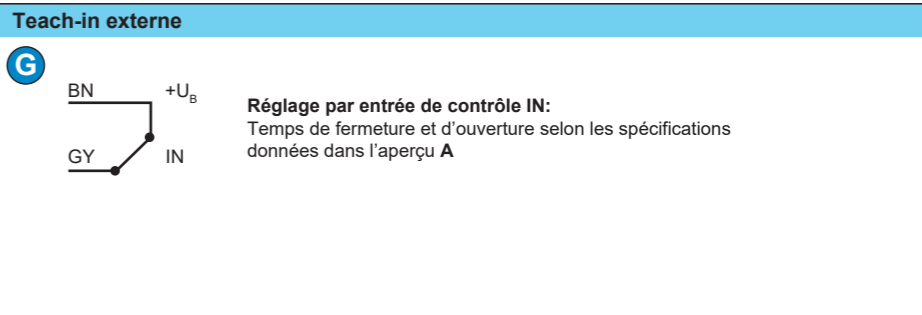
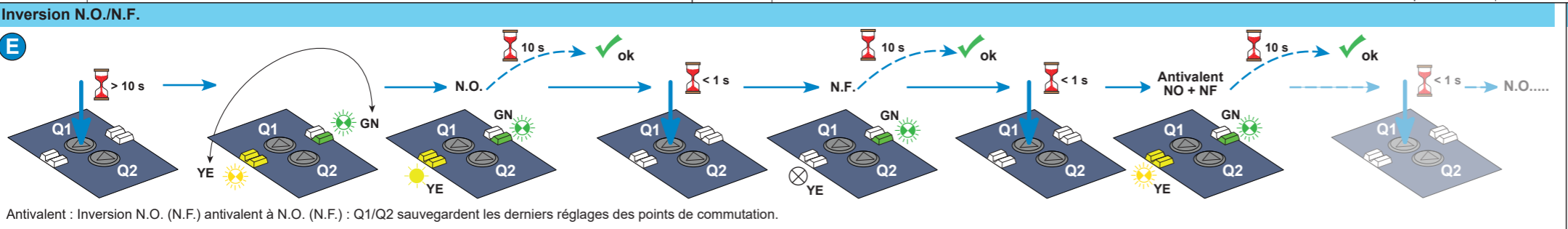
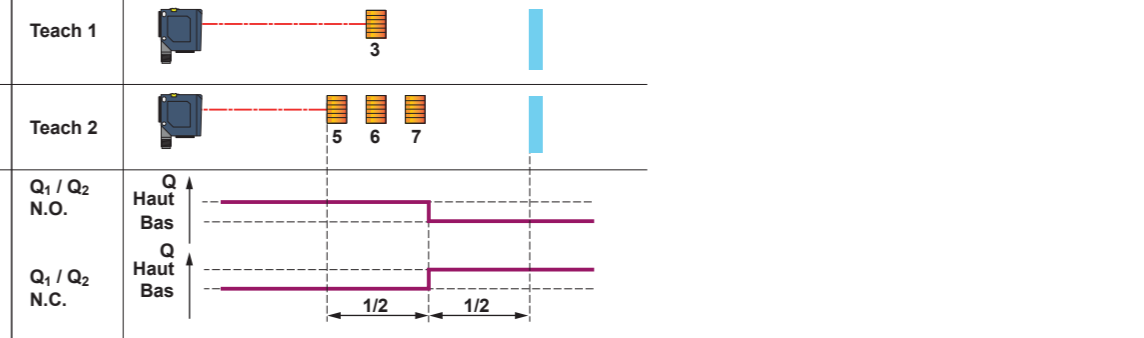
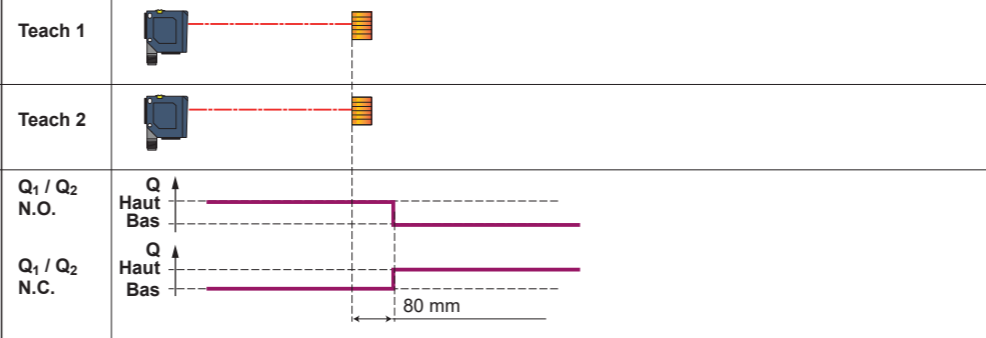
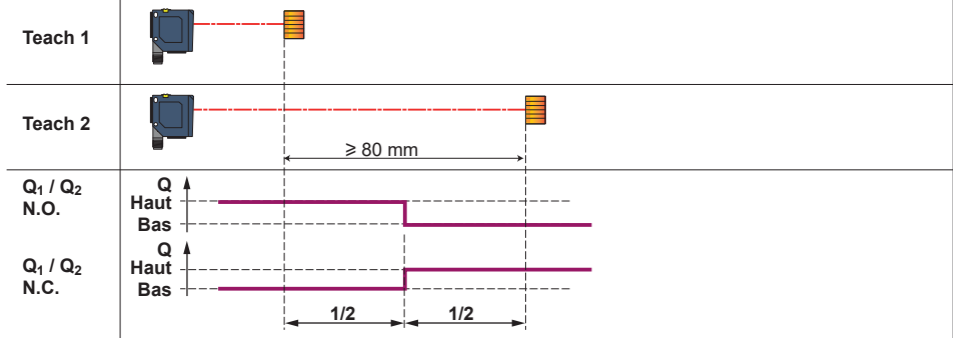
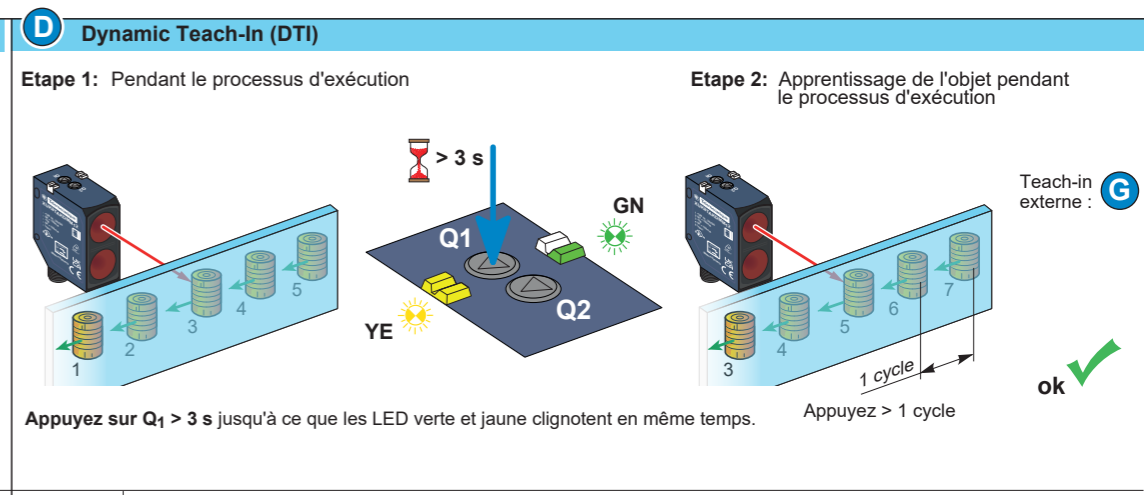
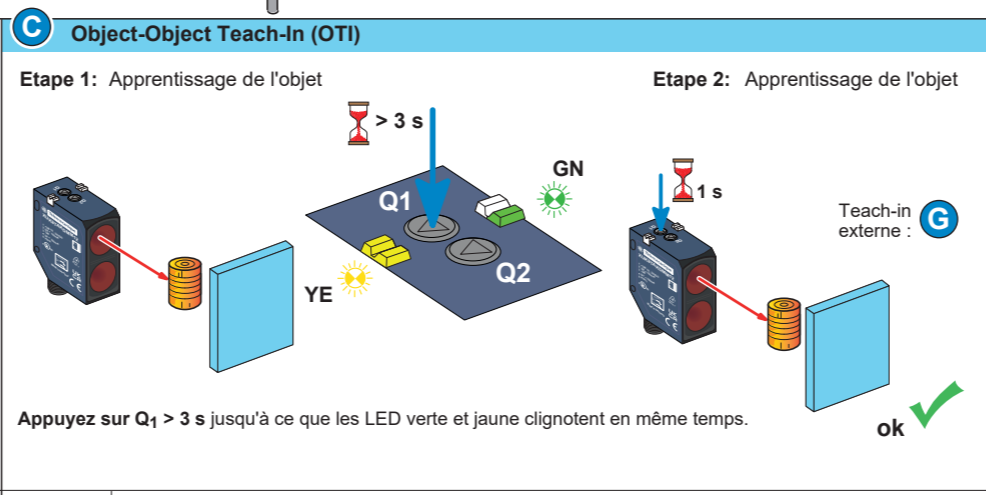
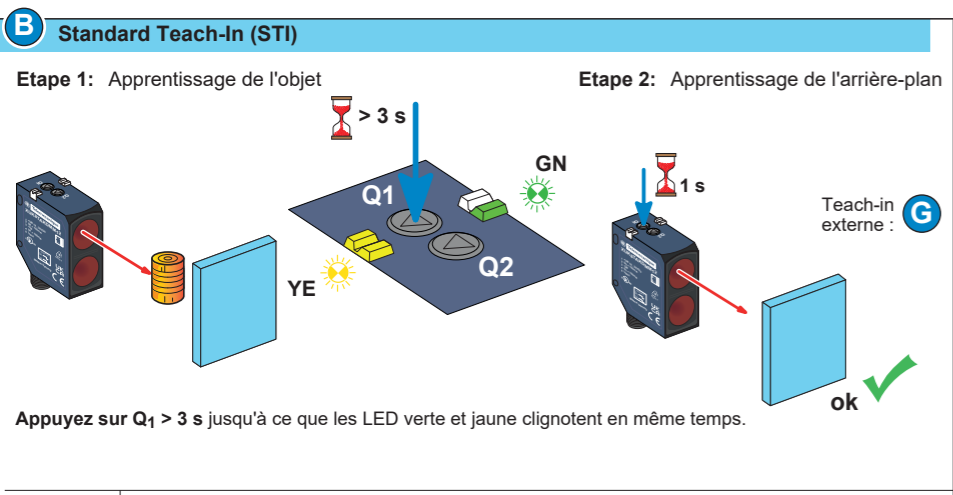
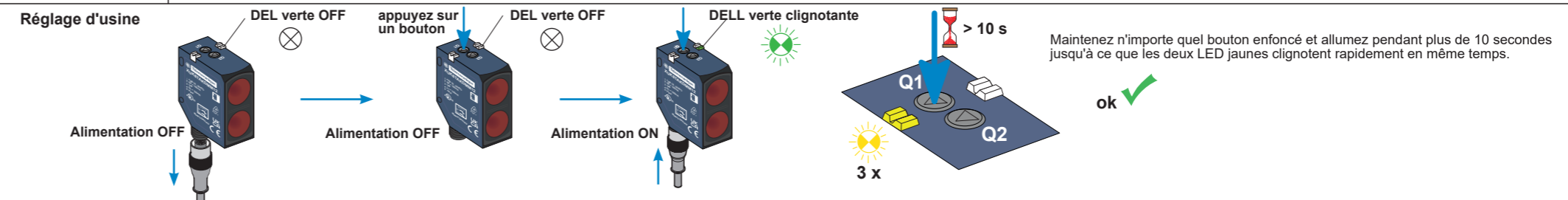

XUK8TAKSMM12 / XUK8TAKDMM12 Reflexions-Distanzsensor mit Hintergrundausbldung

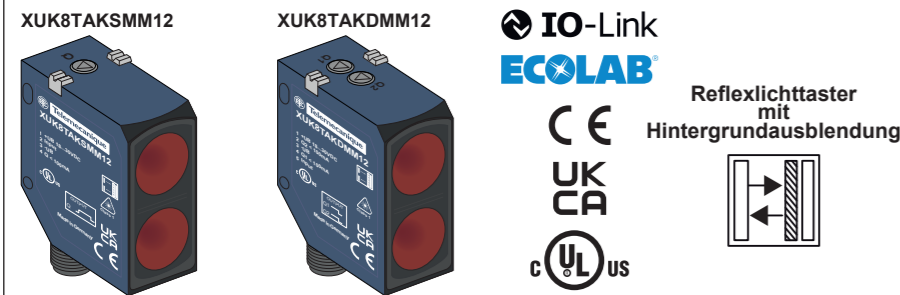

https://tesensors.com/global/en/document/EAV83774

Scannen Sie den Qr-Code, um auf diese Bedienungsanleitung in verschiedenen Sprachen zuzugreifen, oder laden Sie sie von unserer Website herunter : www.tesensors.com

Ihre Kommentare zu diesem Dokument sind uns jederzeit willkommen. Sie können uns über die Kundensupport-Seite auf Ihrer lokalen Website erreichen.

Schutz gegen andere Lichtstrahlen im Farbbereich

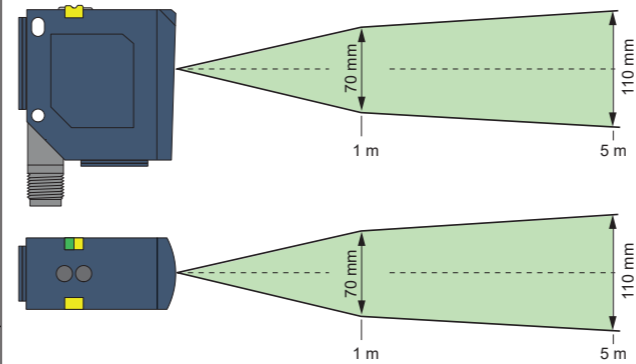

Justage

Einstellung der Lichtfleckposition über optionale Halterung XUZASK004. Sensor auf das zu erfassende Objekt ausrichten. Vorzugsrichtung bei Tastern beachten.

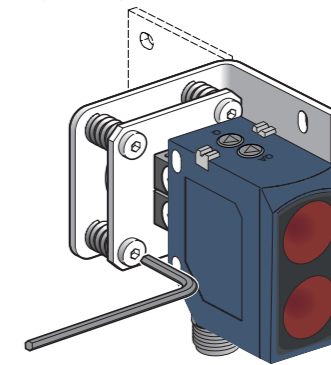

Montage- und Anzugsdrehmomente

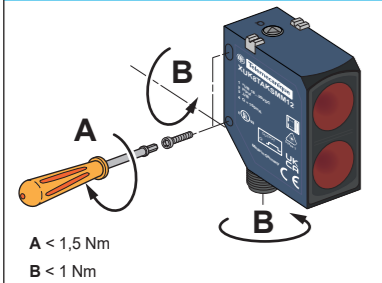

LEDs und Einstellung

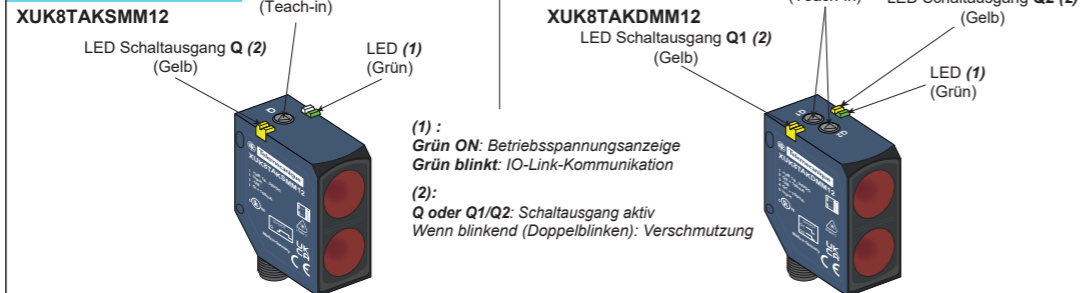

Abmessungen

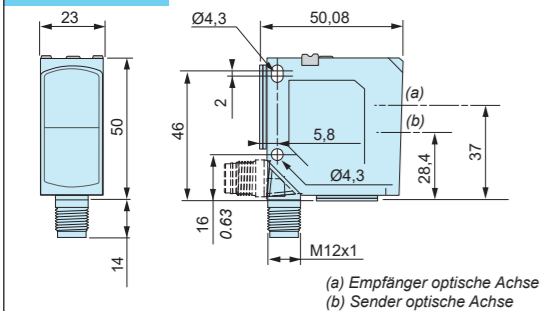

Schaltplan

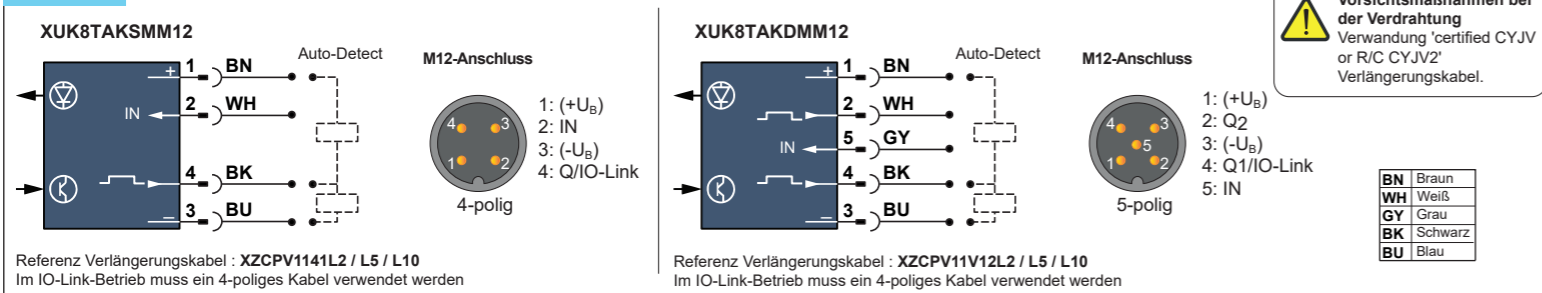

Ansprechkurven

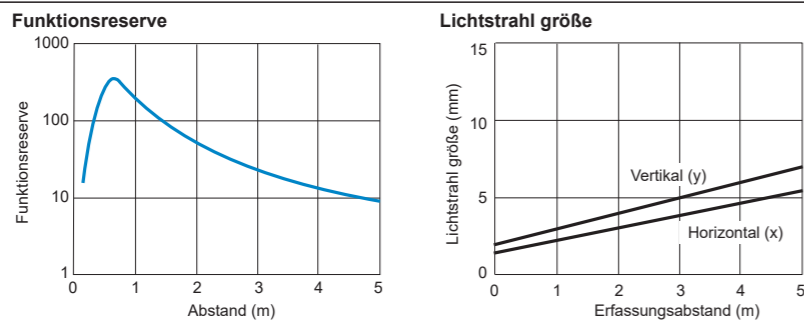

Kenndaten

Zulassungen	CE - UKCA - cULus - Ecolab
Erfassungsabstand (Bezugsmaterial)	Weiß (90%) 0...5 m
	Grau (18%) 0...5 m
	Schwarz (6%) 0,05...3 m
Einstellung	Drucktaste
Lichtsender	Laser, klasse 1 rot, 655 nm
Lichtstrahl Größe	siehe Kurve "Lichtstrahl Größe"
Wellenlänge	λ = 655 nm
	Pulsbreite t < 5 ns
	Frequenz f = 62,5 kHz
	Strahlungsleistung Grenzwert Puls Pp < 1,25 mW
Schaltausgang Q	XUK8TAKSMM12: Auto-Detect PNP/NPN (N.O. oder N.C.) - IOLINK 1 x Auto-Detect (Q)
	XUK8TAKDMM12: 2 x Auto-Detect (Q1, Q2)
Steuereingang IN (Schaltfunktion Q): siehe Grafik G	XUK8TAKSMM12: +U _B = Teach-in -U _B = Geöffnet = Normalbetrieb
	XUK8TAKDMM12: +U _B = - -U _B = Geöffnet = Normalbetrieb
Leerlaufstrom	≤ 60 mA
Schaltstrom	≤ 100 mA
Schaltfrequenz	≤ 500 Hz
Einschaltzeit (erstes Einschalten)	300 ms max.
Ansprechzeit	1,2 ms max.
Bereitstellungszeit	1,2 ms max.
Umgebungstemperatur	Betrieb : - 20...+60 °C Lagerung : - 40...+80 °C
Netzspannung	Bemessungsbetriebsspannung: 24 Vdc Welligkeit p-p maximal 10 % Betriebsbereich: 18...30 Vdc (einschließlich Welligkeit)
Produktschutz	Stromversorgung: Verpolungsschutz Ausgang: Kurzschlusschutz
Schutzklasse	
Schutzart	IP67 entspricht EN/IEC 60529 IP69K entspricht DIN 40050
Vibrations-Resistenz	Frequenzbereich : 10 Hz bis 55 Hz Beschleunigung : 7 gn
Stoßfestigkeit	Spitzenbeschleunigung : 10 gn Dauer des Pulses : 11 ms
Material	Gehäuse : ABS/PC, Linse : PMMA

IO-Link Datenblatt und IO-Link auf der Website : <https://tesensors.com/iolink>

⚠️ WARNUNG
UNBEABSICHTIGTER BETRIEB VON GERÄTEN

- Verdrahtungs- und Konfigurationsanweisungen befolgen.
- Linse regelmäßig säubern und dabei nicht verkratzen.
- Anschlüsse und Befestigungen im Rahmen von Wartungsarbeiten prüfen.

Die Nichtbeachtung dieser Anweisungen kann zu Tod, schwerer Körperverletzung oder Materialschäden führen.

⚠️ VORSICHT
BELASTUNG DURCH GEFÄHRliche LASERSTRAHLUNG

- Nicht in den Laserstrahl blicken.
- Nicht unter - 20 °C betreiben.
- Befolgen Sie alle Betriebsanweisungen.

Die Nichtbeachtung dieser Anweisungen kann zu Körperverletzungen oder Materialschäden führen.

LASERGERÄT DER KLASSE 1
(DIN EN 60825-1)
Entspricht 21 CFR 1040.10 und 1040.11 mit Ausnahme der Abweichungen gemäß Laser Notiz Nr. 50 vom 24. Juni 2007.

Manufacturer :
Schneider Electric Industries SAS
35 rue Joseph Monier
92500 Rueil Malmaison
France

UK Representative :
Schneider Electric Limited
Stafford Park 5
Telford, TF3 3BL
United Kingdom

Уполномоченный поставщик в Республике Казахстан:
ТОО «Шнейдер Электрик»
Адрес: 050010, РК, г. Алматы, пр. Достык, 38, Бизнес Центр «Кен Дала», 5 этаж.
Тел.: +7 (727) 3 57 23 57
Факс.: +7 (727) 357 24 39

Қазақстан Республикасында ресми жеткізуші:
ЖШС «Шнейдер Электрик»
Мекен-жайы: 050010, Қазақстан Республикасы, Алматы қ., Достық даң. 38, «Кен Дала» Бизнес Орталығы, 5-ші қабат.
Тел.: +7 (727) 357 23 57
Факс.: +7 (727) 357 24 39

Zubehör

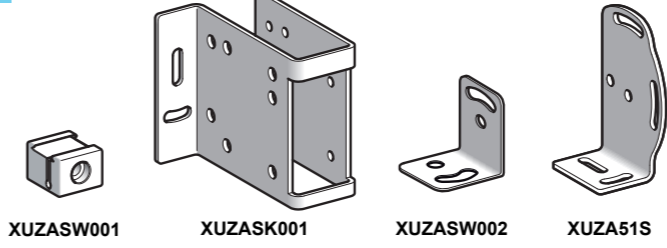

Elektrische Geräte dürfen ausschließlich von qualifiziertem Fachpersonal installiert, bedient und gewartet werden. Schneider Electric haftet für keinerlei Folgen, die sich ggf. aus der Verwendung dieses Materials ergeben.

© 2022 Schneider Electric. "All Rights Reserved."

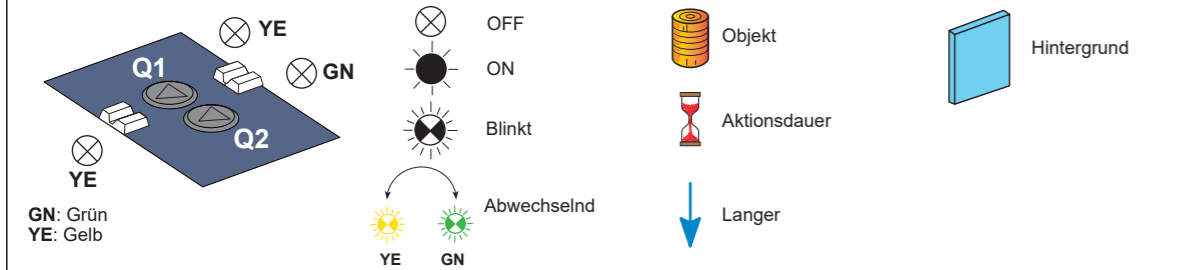

Einstellungen
 Der Sensor verfügt über 3 unterschiedliche Teach-in-Modi. Die Variante XUK8TAKDMM12 besitzt zwei unabhängig voneinander einstellbare Schaltausgänge.
Standard Teach-in (STI): ist für nahezu jede Anwendung geeignet. Einstellung erfolgt auf das Objekt und den Hintergrund (s. Kapitel B)
Object-Object Teach-in (OTI): ist geeignet für Anwendungen bei denen der Hintergrund nicht eingelernt werden kann. Einstellung erfolgt 2x auf das Objekt (s. Kapitel C).
Dynamic Teach-in (DTI): ist geeignet den Sensor im laufenden Prozess einzustellen (s. Kapitel D).

Übersicht

Funktion	Aktionsschritt 1 (1)	Externes Teach-in	Siehe Abbildung
Schaltausgang 1	drücken Sie Q ₁ > 3 s	IN verbinden > 3 s	B / C / D
Schaltausgang 2 (2)	drücken Sie Q ₂ > 3 s	IN verbinden > 6 s	B / C / D
N.O. / N.C. / Antivalent (NO + NC)	drücken Sie Q > 10 s	IN verbinden > 10 s	E
Auto-Detect / NPN / PNP	drücken Sie Q > 13 s	IN verbinden > 13 s	F

(1) Schritt 2: Q₁ (oder Q₂) drücken / IN verbinden > 1 s
 (2) Alle XUK8TAKMM12

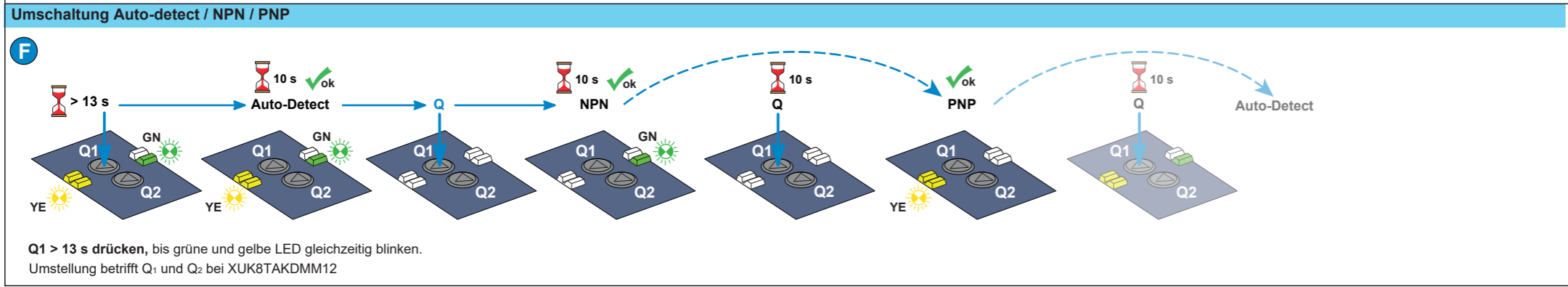
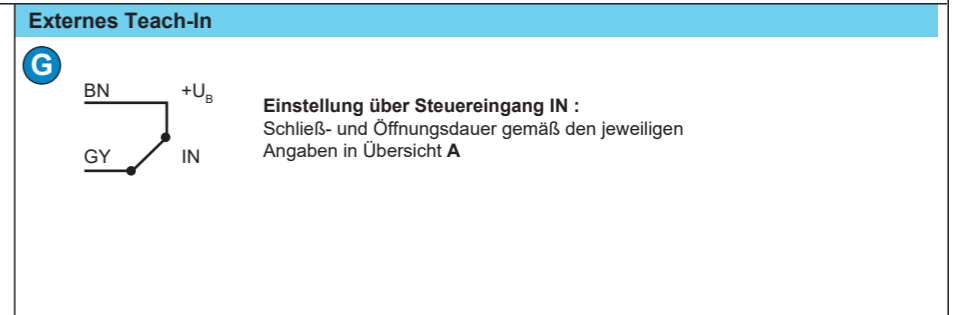
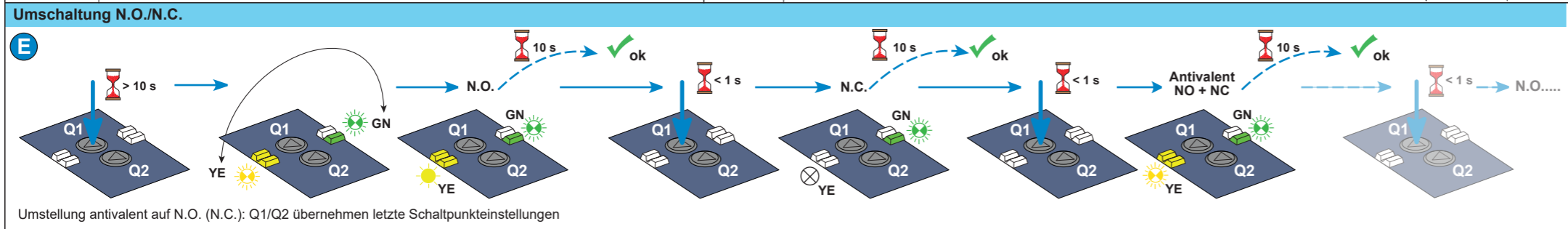
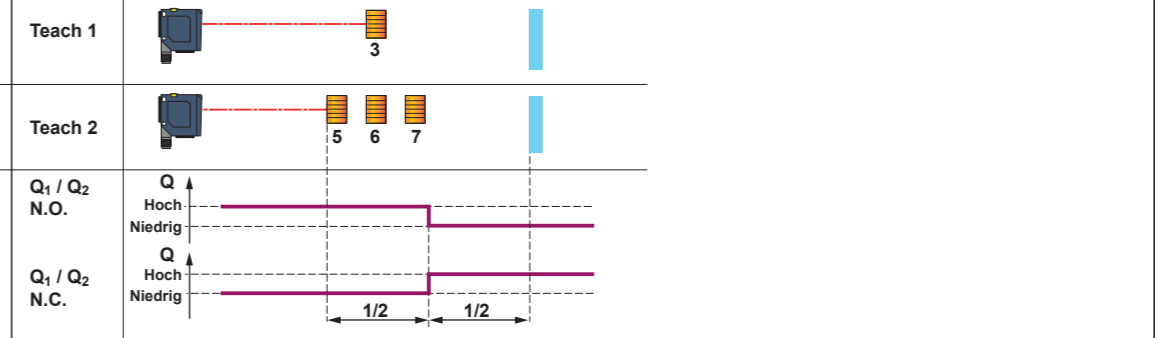
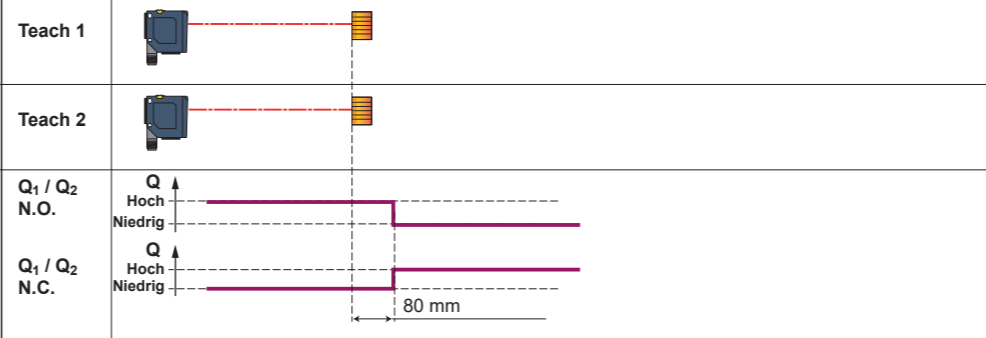
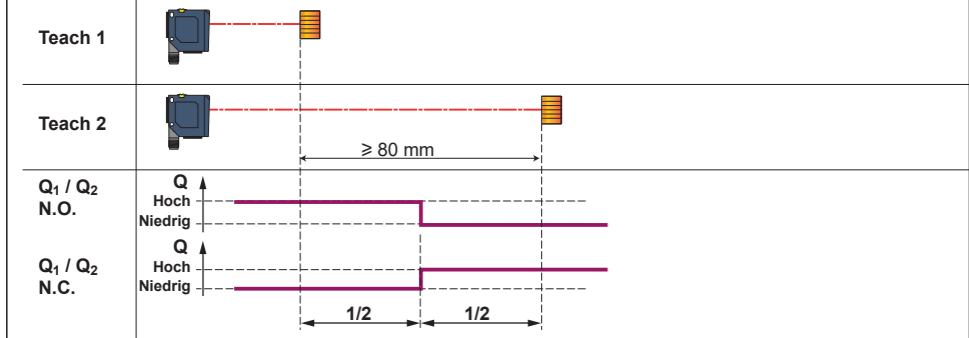
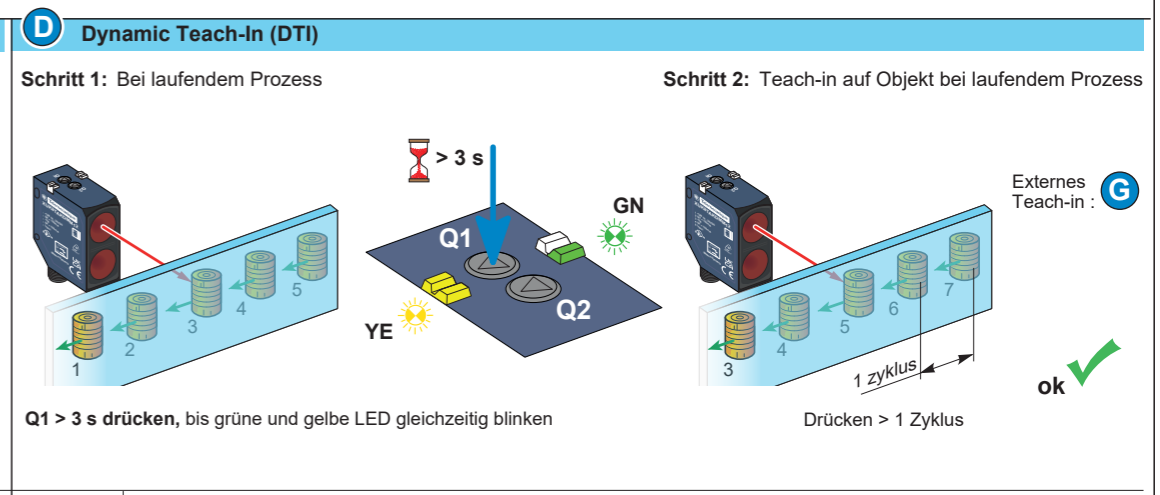
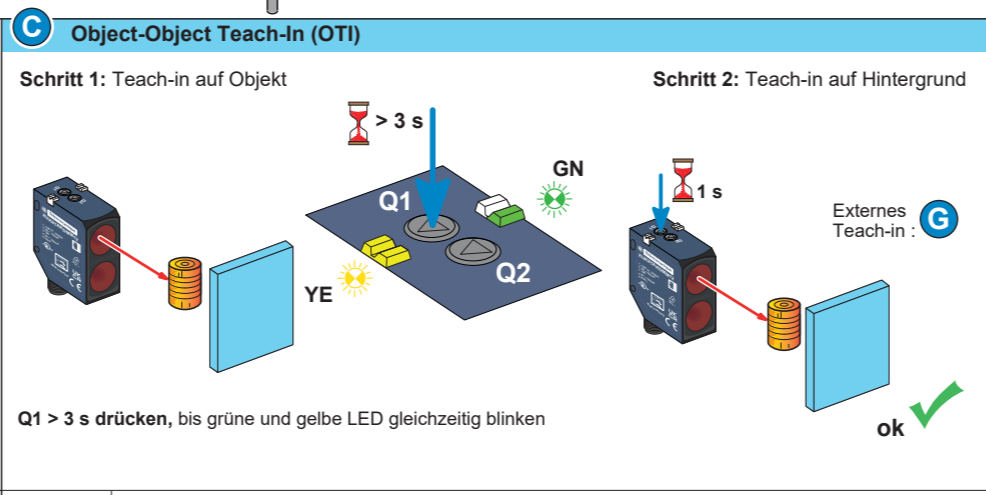
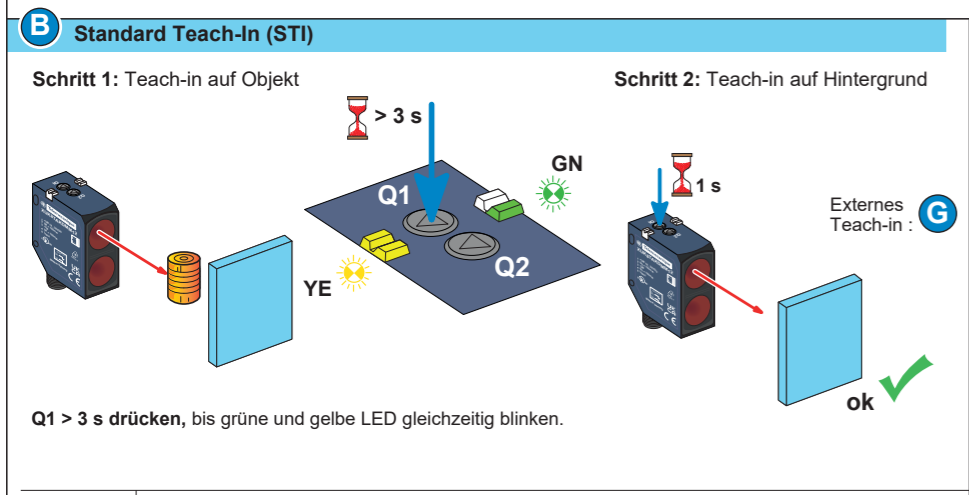
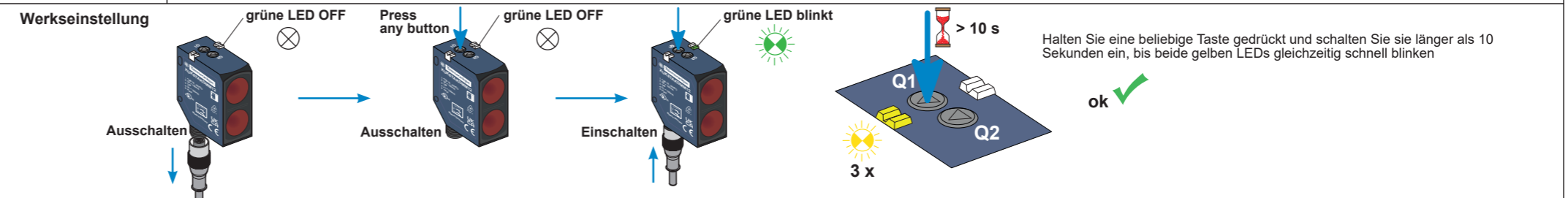

XUK8TAKSMM12 / XUK8TAKDMM12 Sensor de distancia autorreflexivo con supresión de fondo

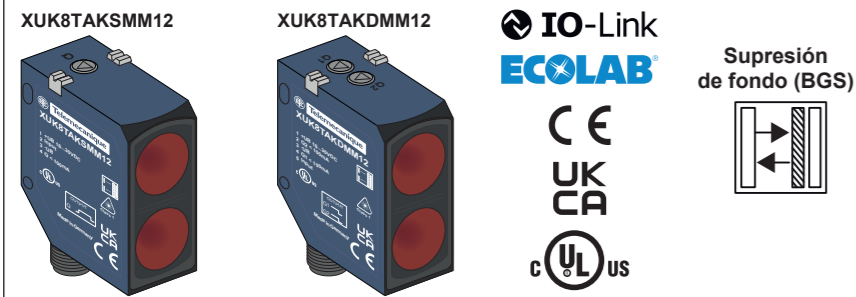

https://tesensors.com/global/en/document/EAV83774
 Escanee el código Qr para acceder a esta hoja de instrucciones en diferentes idiomas o puede descargarlo de nuestro sitio web en : www.tesensors.com
 Agradecemos sus comentarios sobre este documento. Puede comunicarse con nosotros a través de la página de atención al cliente en su sitio web local.

Prevención frente a otros haces de luz en la zona coloreada

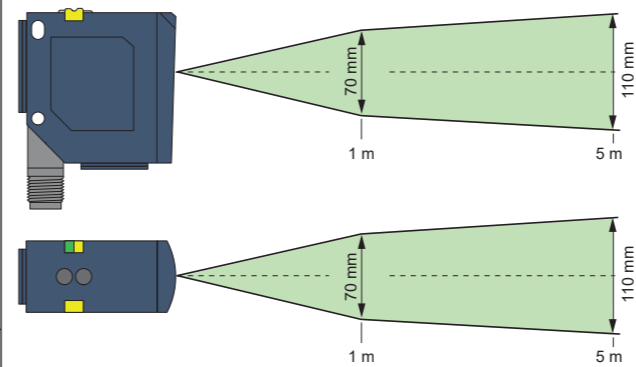

Ajuste

Ajuste de la posición del punto luminoso mediante el ángulo de montaje opcional XUZASK004. Oriente el sensor hacia el objeto que deba detectarse. Tenga en cuenta la dirección preferente en los interruptores.

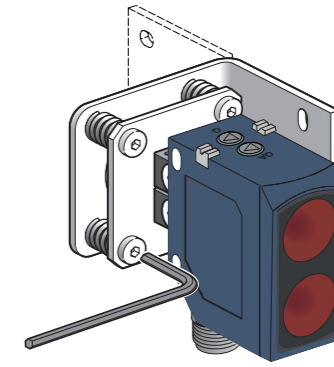

El montaje y pares de apriete

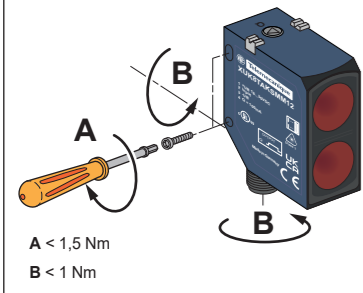

LED y configuraciones

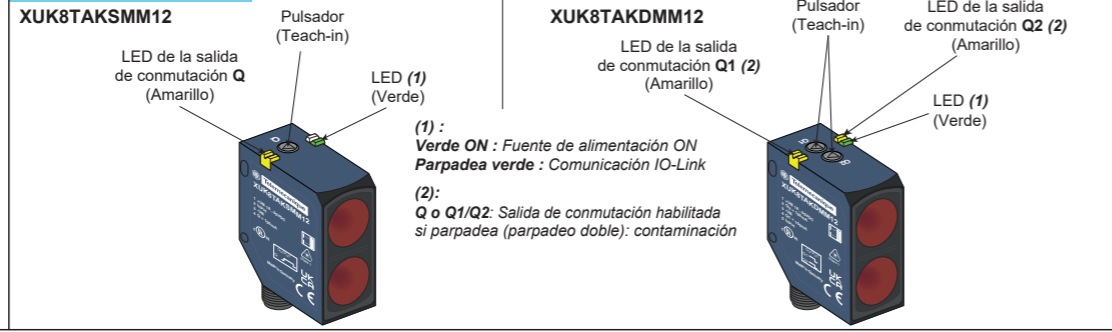

Dimensiones

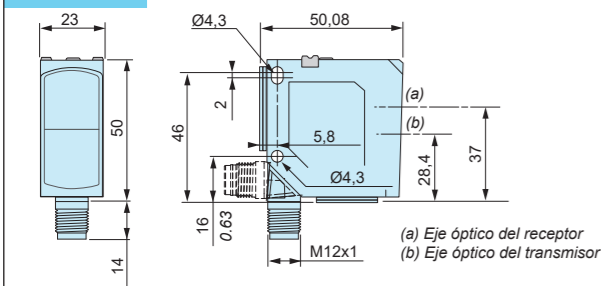

Diagramas de cableado

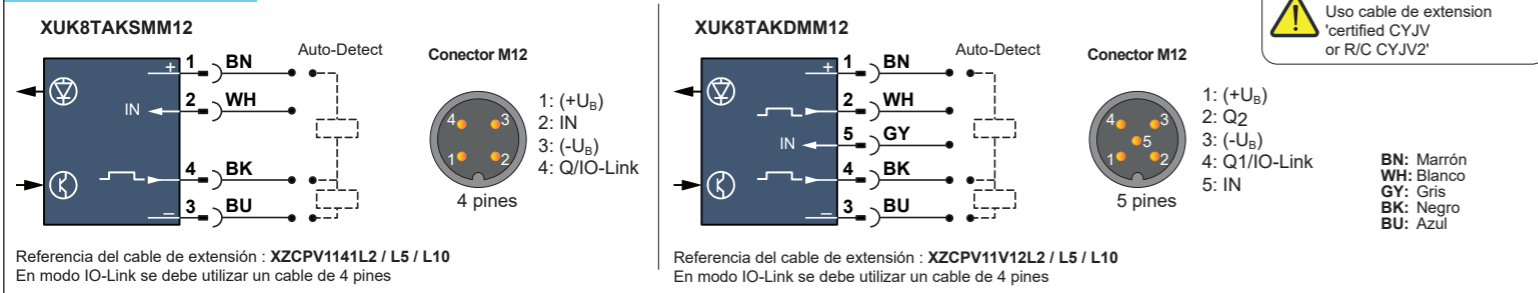

Curvas de detección

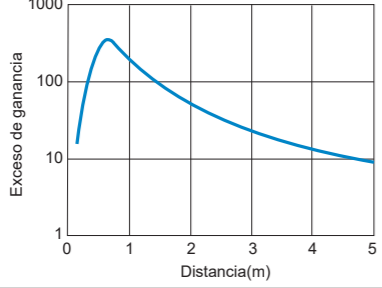

Tamaño del haz de luz

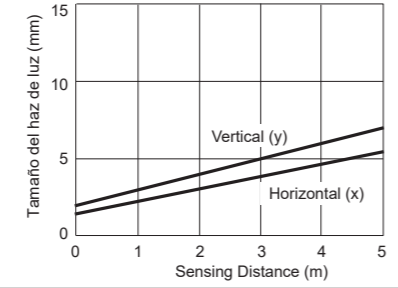

Características

Certificación	Blanco (90%)	CE - UKCA - cULus - Ecolab
Distancia de detección (Material de referencia)	Gris (18%)	0...5 m
	Negro (6%)	0,05...3 m
		Botón pulsador
Ajuste	Color del haz de luz de detección	Láser clase 1, rojo, 655 nm
Tamaño del punto del haz de luz	véase la curva "Tamaño del haz de luz"	
Longitud de onda	Duración de los pulsos	$\lambda = 655 \text{ nm}$
	Frecuencia	$t < 5 \text{ ns}$
	Límite de pulso de potencia radiante	$f = 62,5 \text{ kHz}$
		$P_p < 1,25 \text{ mW}$
Salida de conmutación Q	XUK8TAKSMM12	Auto-Detect PNP/NPN (N.A. o N.C.) - IOLINK
	XUK8TAKDMM12	1 x Auto-Detect (Q) 2 x Auto-Detect (Q1, Q2)
Entrada de control IN (función de conmutación Q): véase el gráfico G	XUK8TAKSMM12	+U _B = Teach-in
	XUK8TAKDMM12	-U _B = abrir = funcionamiento normal
Consumo de corriente	Capacidad de conmutación	≤ 60 mA
Capacidad de conmutación	Frecuencia de cambio	≤ 100 mA
Frecuencia de cambio	Demora al encendido	≤ 500 Hz
Demora al encendido	Tiempo de respuesta	300 ms max.
Tiempo de respuesta	Tiempo de recuperación	1,2 ms max.
Tiempo de recuperación	Temperatura ambiente	1,2 ms max.
Temperatura ambiente	Tensión de alimentación	En funcionamiento : - 20...+60 °C
Tensión de alimentación	Protección del producto	Almacenamiento : - 40...+80 °C
		24 V CC Rizado p-p 10% máximo - Rango de funcionamiento 18 ... 30 V CC (incluido rizado)
Protección del producto	Fuente de alimentación : protección contra polaridad inversa	
Clase de protección	Salida: protección contra cortocircuitos	
Grado de protección	IP67 conforme a EN/IEC 60529	
Resistencia de vibración	IP69K conforme a DIN 40050	
Resistencia a los golpes	Rango de frecuencia: 10 Hz a 55 Hz	
Materiaesl	Aceleración: 7 gn	
	Aceleración máxima: 10 gn	
	Duración del pulso: 11 ms	
	Carcasa : ABS/PC, Lente : PMMA	

IO-Link Ficha de datos e IO-Link en el sitio web : <https://tesensors.com/iolink>

ADVERTENCIA
FUNCIONAMIENTO INESPERADO DEL EQUIPO
 ● Cumpla con las instrucciones de cableado y configuración.
 ● Limpie la lente con regularidad y tenga cuidado de no rayarla.
 ● Compruebe las conexiones y las fijaciones durante las operaciones de mantenimiento.
Si no se siguen estas instrucciones pueden producirse lesiones personales graves o mortales o daños en el equipo.

AVISO
PELIGRO DE EXPOSICIÓN A LA RADIACIÓN LÁSER
 ● No fije la mirada en el haz.
 ● No utilice el aparato por debajo de los - 20 °C.
 ● Siga todas las instrucciones de funcionamiento.
Si no se siguen estas instrucciones pueden producirse lesiones personales o daños en el equipo.

PRODUCTO LÁSER DE CLASE 1
 (DIN EN 60825-1)
 Cumple las normas 21 CFR 1040.10 y 1040.11, a excepción de las desviaciones según la nota sobre láser nº 50 del 24 de junio de 2007

Manufacturer :
 Schneider Electric Industries SAS
 35 rue Joseph Monier
 92500 Rueil Malmaison
 France

UK Representative :
 Schneider Electric Limited
 Stafford Park 5
 Telford, TF3 3BL
 United Kingdom

Уполномоченный поставщик в Республике Казахстан:
 ТОО «Шнейдер Электрик»
 Адрес: 050010, РК, г. Алматы, пр. Достык, 38, Бизнес Центр «Кен Дала», 5 этаж.
 Тел.: +7 (727) 3 57 23 57
 Факс.: +7 (727) 357 24 39

Қазақстан Республикасында ресми жеткізуші:
 ЖШС «Шнейдер Электрик»
 Мекен-жайы: 050010, Қазақстан Республикасы, Алматы қ., Достық даң. 38, «Кен Дала» Бизнес Орталығы, 5-ші қабат.
 Тел.: +7 (727) 357 23 57
 Факс.: +7 (727) 357 24 39

Accesorios

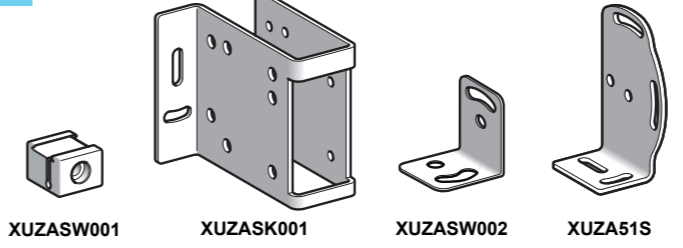

La instalación, el manejo y el mantenimiento de los equipos eléctricos deberán ser realizados sólo por personal cualificado. Schneider Electric no se hace responsable de ninguna de las consecuencias del uso de este material.

© 2022 Schneider Electric. "All Rights Reserved."

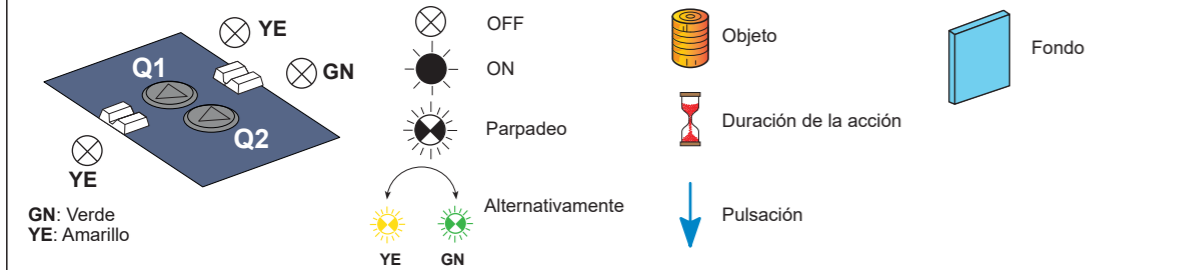

Ajuste
El sensor dispone de 3 modos Teach-in diferentes. La variante XUK8TAKDMM12 tiene dos salidas de conmutación ajustables de forma independiente la una de la otra.

Standard Teach-in (STI): adecuado casi para cualquier uso. La configuración se realiza hacia el objeto y el fondo (véase Capítulo B).

Object-Object Teach-in (OTI): es adecuado para usos en los que no se pueda entrenar el fondo. La configuración se realiza 2 veces sobre el objeto (véase Capítulo C).

Dynamic Teach-in (DTI): es adecuado para configurar el sensor con el proceso en marcha (véase Capítulo D).

Visión general

Función	Acción Paso 1 (1)	Teach-in externo	Ver ilustración
Salida de conmutación 1	pulse Q ₁ > 3 s	conectar IN > 3 s	B / C / D
Salida de conmutación 2 (2)	pulse Q ₂ > 3 s	conectar IN > 6 s	B / C / D
N.A. / N.C. / Antivalente (NO + NC)	pulse Q > 10 s	conectar IN > 10 s	E
Auto-Detect / NPN / PNP	pulse Q > 13 s	conectar IN > 13 s	F

(1) Paso 2: pulse Q₁ (or Q₂) / conectar IN > 1 s
(2) Todos los XUK8TAKMM12

