

Protection equipment

**Price groups**

PG 12P, 14O, 41B, 41E, 41F, 41G, 41H, 41J, 42F, 42J

7/2

Introduction**Motor starter protectors/
circuit breakers**

SIRIUS 3RV2 motor starter protectors/circuit breakers

7/6

General data

7/27

For motor protection

7/35

For motor protection with overload relay function

7/37

For starter combinations

7/40

For transformer protection

7/44

For system protection

7/45

For system protection according to UL 489/CSA C22.2 No. 5

7/46

For transformer protection according to UL 489/CSA C22.2 No. 5

Accessories

7/47

- Mountable accessories

7/50

- Busbar accessories

7/54

- Rotary operating mechanisms

7/57

- Mounting accessories

7/64

- Enclosures and front plates

7/67

3RV29 infeed system

SIRIUS 3RV1 motor starter protectors/circuit breakers

7/73

For fuse monitoring

7/74

For distance protection

7/75

For motor protection

Overload relays

7/76

General data

SIRIUS 3RU2 thermal overload relays

7/83

3RU2 for standard applications

7/93

Accessories

SIRIUS 3RB3 electronic overload relays

7/95

3RB30, 3RB31 for standard applications

7/105

Accessories

SIRIUS 3RB2 electronic overload relays

7/107

3RB20, 3RB21 for standard applications

7/117

Accessories for 3RB20, 3RB21

7/119

3RB22, 3RB23 for high-feature applications

7/127

3RB24 for IO-Link for high-feature applications

7/134

Current measuring modules for 3RB22, 3RB23 and 3RB24

7/138

Accessories for 3RB22, 3RB23, 3RB24

Protection equipment

Introduction

Overview

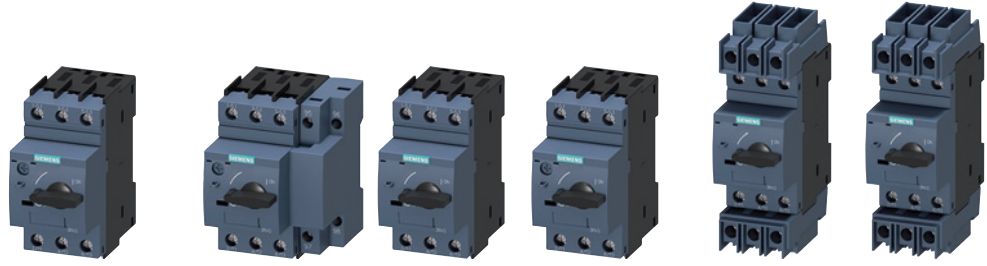

Type	3RV20	3RV21	3RV23	3RV24	3RV27	3RV28
SIRIUS 3RV2 motor starter protectors/circuit breakers						
Applications						
• System protection	✓ ¹⁾ / 3RV20...-.....-0DA0 ²⁾	✓ ¹⁾	--	--	✓	✓
• Motor protection	✓	--	--	--	--	--
• Motor protection with overload relay function	--	✓	--	--	--	--
• Starter combinations	--	--	✓	--	--	--
• Transformer protection	--	--	--	✓/ 3RV24...-.....-0DA0 ²⁾	--	✓
Size	S00, S0, S2, S3	S00, S0, S2, S3	S00, S0, S2, S3	S00, S0, S2	S00, S0, S3	S00, S0
Rated current I_n						
• Size S00	A Up to 16	Up to 16	Up to 16	Up to 16	Up to 15	Up to 15
• Size S0	A Up to 40	Up to 32	Up to 40	Up to 25	Up to 22	Up to 22
• Size S2	A Up to 80	Up to 80	Up to 80	Up to 65	--	--
• Size S3	A Up to 100	Up to 100	Up to 100	--	Up to 70	--
Rated operational voltage U_e according to IEC	V 690 AC ³⁾	690 AC ³⁾	690 AC ³⁾	690 AC ³⁾	690 AC	690 AC
Rated frequency	Hz 50/60	50/60	50/60	50/60	50/60	50/60
Trip class	CLASS 10 (S00 ... S3), CLASS 20 (S2, S3)	CLASS 10	--	CLASS 10	--	--
Thermal overload release	A 0.11 ... 0.16 to A 80 ... 100	0.11 ... 0.16 to 80 ... 100	None ⁴⁾	0.11 ... 0.16 to 54 ... 65	0.16 ... 70 Non-adjustable	0.16 ... 22 Non-adjustable
Electronic release A multiple of the rated current	13 times	13 times	13 times	20 times	13 times	20 times
Short-circuit breaking capacity I_{cu} at 400 V AC	kA 20/55/65/100	55/65/100	20/55/65/100	55/65/100	⁵⁾	⁵⁾
Pages	7/27 ... 7/34	7/35, 7/36	7/37 ... 7/39	7/40, 7/41	7/45	7/46

Accessories																				
For sizes	S00	S0	S2	S3	S00	S0	S2	S3	S00	S0	S2	S3	S00	S0	S2	S00	S0	S3	S00	S0
Auxiliary switches	✓	✓	✓	✓	✓	✓	✓	✓	✓	✓	✓	✓	✓	✓	✓	✓	✓	✓ ⁶⁾	✓	✓
Signaling switches	✓	✓	✓	✓	✓	✓	✓	✓	✓	✓	✓	✓	✓	✓	✓	✓	✓	--	--	--
Undervoltage releases	✓	✓	✓	✓	--	--	--	--	✓	✓	✓	✓	✓	✓	✓	✓	✓	✓	✓	✓
Shunt releases	✓	✓	✓	✓	--	--	--	--	✓	✓	✓	✓	✓	✓	✓	✓	✓	✓	✓	✓
Isolator modules	✓	✓	✓	--	✓	✓	✓	--	✓	✓	✓	--	✓	✓	✓	--	--	--	--	--
Insulated 3-phase busbar system	✓	✓	✓	--	--	--	✓	--	✓	✓	✓	--	✓	✓	✓	✓	✓	--	✓	✓
Busbar adapters	✓	✓	✓	✓	✓	✓	✓	✓	✓	✓	✓	✓	✓	✓	✓	✓	✓	✓	✓	--
Door-coupling rotary operating mechanisms	✓	✓	✓	✓	✓	✓	✓	✓	✓	✓	✓	✓	✓	✓	✓	✓	✓	✓	✓	✓
Link modules	✓	✓	✓	✓	✓	✓	✓	✓	✓	✓	✓	✓	✓	✓	✓	--	--	--	--	--
Enclosures for surface mounting	✓	✓	✓	--	✓	✓	✓	--	✓	✓	✓	--	✓	✓	✓	--	--	--	--	--
Enclosures for flush mounting	✓	✓	--	--	✓	✓	--	--	✓	✓	--	--	✓	✓	--	--	--	--	--	--
Front plates	✓	✓	✓	✓	✓	✓	✓	✓	✓	✓	✓	✓	✓	✓	✓	--	--	--	--	--
Infeed system	✓	✓	--	--	--	--	--	--	✓	✓	--	--	✓	✓	--	✓	✓	--	✓	✓
Sealable scale covers for setting knobs	✓	✓	✓	✓	✓	✓	✓	✓	--	--	--	--	✓	✓	✓	--	--	--	--	--
Pages	7/47 ... 7/66																			

✓ Has this function or can use this accessory

-- Does not have this function or cannot use this accessory

¹⁾ For symmetrical loading of the three phases.

²⁾ For 1-phase, 2-phase and 3-phase asymmetrical loading of the three phases.

³⁾ With molded-plastic enclosure 500 V AC.

⁴⁾ For overload protection of the motors, appropriate overload relays must be used.

⁵⁾ According to UL 489 at 480 Y/277 V AC: 65 kA or 50 kA.

⁶⁾ Only lateral auxiliary switches can be used



Type	3RV1611-0BD10		3RV1611-1.G14		3RV1011	
SIRIUS 3RV1 motor starter protectors/circuit breakers						
Applications						
• Motor protection	--		--		✓	
• Fuse monitoring	✓		--		--	
• Voltage transformer circuit breakers for distance protection	--		✓		--	
Size						
Rated current I_n	A	0.2	Up to 3		Up to 12	
Rated operational voltage U_e according to IEC	V	690 AC ¹⁾	400 AC		690 AC	
Rated frequency	Hz	50/60	16 ² / ₃ ... 60		50/60	
Trip class	--		--		CLASS 10	
Thermal overload release	A	0.2	1.4 ... 3		0.11 ... 0.16 to 9 ... 12	
Electronic release						
A multiple of the rated current	6 times		4 ... 7 times		13 times	
Short-circuit breaking capacity I_{cu} at 400 V AC	kA	100	50		100/50	
Pages	7/73		7/74		7/75	
Accessories						
For sizes	S00		S00		S00	
Auxiliary switches	✓		✓		✓	
Further accessories	--		--		✓	
Pages	7/73		7/74		7/47 ... 7/72	

✓ Has this function or can use this accessory

-- Does not have this function or cannot use this accessory

¹⁾ With molded-plastic enclosure 500 V AC.

Protection equipment

Introduction



**Thermal overload relays
for standard applications**
3RU21

**Electronic overload relays
for standard applications**
3RB30

3RB31

Type

SIRIUS overload relays

Applications

• System protection	✓ ¹⁾	✓ ¹⁾	✓ ¹⁾
• Motor protection	✓	✓	✓
• Alternating current, 3-phase	✓	✓	✓
• Alternating current, 1-phase	✓	--	--
• Direct current	✓	--	--
Size contactor	S00, S0, S2, S3	S00, S0, S2, S3	S00, S0, S2, S3
Rated operational current I_e			
• Size S00	A Up to 16	Up to 16	Up to 16
• Size S0	A Up to 40	Up to 40	Up to 40
• Size S2	A Up to 80	Up to 80	Up to 80
• Size S3	A Up to 100	Up to 115	Up to 115
Rated operational voltage U_e	V 690 AC	690 AC	690 AC
Rated frequency	Hz 50/60	50/60	50/60
Trip class	CLASS 10, 10A	CLASS 10E, 20E	CLASS 5E, 10E, 20E, 30E (adjustable)
Thermal overload release	A 0.11 ... 0.16 to A 80 ... 100	--	--
Electronic overload releases	A -- A	0.1 ... 0.4 to 32 ... 115	0.1 ... 0.4 to 32 ... 115
Pages	7/89 ... 7/92	7/102, 7/103	7/104

Accessories

For sizes	S00	S0	S2	S3	S00	S0	S2	S3	S00	S0	S2	S3
Terminal supports for stand-alone installation	✓	✓	✓	✓	✓	✓	✓	✓	✓	✓	✓	✓
Mechanical RESET	✓	✓	✓	✓	✓	✓	✓	✓	✓	✓	✓	✓
Cable releases for RESET	✓	✓	✓	✓	✓	✓	✓	✓	✓	✓	✓	✓
Electrical Remote RESET	✓	✓	✓	✓	--	--	--	--	Integrated in the unit			
Terminal covers for box terminal	--	--	✓	✓	--	--	✓	✓	--	--	✓	✓
Sealable covers for setting knobs	✓	✓	✓	✓	✓	✓	✓	✓	✓	✓	✓	✓
Pages	7/93, 7/94				7/105, 7/106				7/105, 7/106			

✓ Has this function or can use this accessory

-- Does not have this function or cannot use this accessory

¹⁾ The units are responsible in the main circuit for overload protection of the assigned electrical loads (e.g. motors), feeder cable, and other switching and protection devices in the respective load feeder.



**Electronic overload relays
for standard applications**

for high-feature applications

**Electronic overload relays for IO-Link
for high-feature applications**

Type	3RB20	3RB21	3RB22, 3RB23	3RB24
SIRIUS overload relays				
Applications				
• System protection	✓ ¹⁾	✓ ¹⁾	✓ ¹⁾	
• Motor protection	✓	✓	✓	
• Alternating current, 3-phase	✓	✓	✓	
• Alternating current, 1-phase	--	--	✓	
• Direct current	--	--	--	
Size contactor	S6 ... S12	S6 ... S12	S00 ... S12	
Rated operational current I_e				
• Sizes S00 and S0	A --	--	Up to 25 and 45 mm width with current measuring modules 3RB2906-2BG1/3RB2906-2DG1	
• Size S2	A --	--	Up to 100 and 55 mm width with current measuring module 3RB2906-2JG1	
• Size S3	A --	--		
• Size S6	A Up to 200	Up to 200	Up to 200 and 120 mm width with current measuring modules 3RB2956-2TH2/3RB2956-2TG2	
• Size S10/S12	A Up to 630	Up to 630	Up to 630 and 145 mm width with current measuring module 3RB2966-2WH2	
• Size 14 (3TF68/3TF69)	A Up to 630	Up to 630	Up to 820 with current measuring module 3RB2906-2BG1 and transformer 3UF1868-3GA00	
Rated operational voltage U_e	V 690/1 000 AC	690/1 000 AC	690/1 000 AC ²⁾	
Rated frequency	Hz 50/60	50/60	50/60	
Trip class	CLASS 10, 20	CLASS 5, 10, 20, 30 adjustable	CLASS 5, 10, 20, 30 adjustable	
Thermal overload release	A --	--	--	
Electronic overload releases	A 50 ... 200 to A 160 ... 630	50 ... 200 to 160 ... 630	0.3 ... 3 to 63 ... 630	
Pages	7/114, 7/115	7/116	7/125, 7/126, 7/137	7/133, 7/137

Accessories											
For sizes	S6	S10/S12	S6	S10/S12	S00	S0	S2	S3	S6	S10/S12	
Terminal supports for stand-alone installation	3)	3)	3)	3)	3)	3)	3)	3)	3)	3)	
Mechanical RESET	✓	✓	✓	✓	--	--	--	--	--	--	
Cable releases for RESET	✓	✓	✓	✓	--	--	--	--	--	--	
Electrical Remote RESET	--	--	Integrated in the unit		Integrated in the unit						
Terminal covers	✓	✓	✓	✓	--	--	--	✓	✓	✓	
Sealable covers for setting knobs	✓	✓	✓	✓	✓	✓	✓	✓	✓	✓	
Operator panel for 3RB24 evaluation module	--	--	--	--	✓	✓	✓	✓	✓	✓	
Pages	7/117, 7/118		7/117, 7/118		7/137 ... 7/139						

- ✓ Has this function or can use this accessory
 -- Does not have this function or cannot use this accessory

- ¹⁾ The units are responsible in the main circuit for overload protection of the assigned electrical loads (e.g. motors), feeder cable, and other switching and protection devices in the respective load feeder.
²⁾ With reference to the 3RB29.6 current measuring modules.
³⁾ Stand-alone installation without accessories is possible.

Protection equipment

Motor starter protectors/circuit breakers

SIRIUS 3RV2 motor starter protectors/circuit breakers

General data

Overview

More information

Homepage, see www.siemens.com/sirius-circuit-breakers
 Industry Mall, see www.siemens.com/product?3RV2
 TIA Selection Tool Cloud (TST Cloud), see www.siemens.com/tstcloud/?node=MotorStarterProtector
 Conversion tool, see www.siemens.com/conversion-tool

Application Manual for switching devices with IE3 and IE4 motors, see <https://support.industry.siemens.com/cs/ww/en/view/94770820>
 System Manual for modular system, see <https://support.industry.siemens.com/cs/ww/en/view/60311318>
 Equipment Manual, see <https://support.industry.siemens.com/cs/ww/en/view/60279172>
 Certificates, see <https://support.industry.siemens.com/cs/ww/en/ps/16245/cert>

The following illustration shows 3RV2 motor starter protectors/circuit breakers with the accessories which can be mounted for the sizes S00 to S3, see also "Introduction" → "Overview", page 7/2.

Accessories, see page 7/47 onwards.

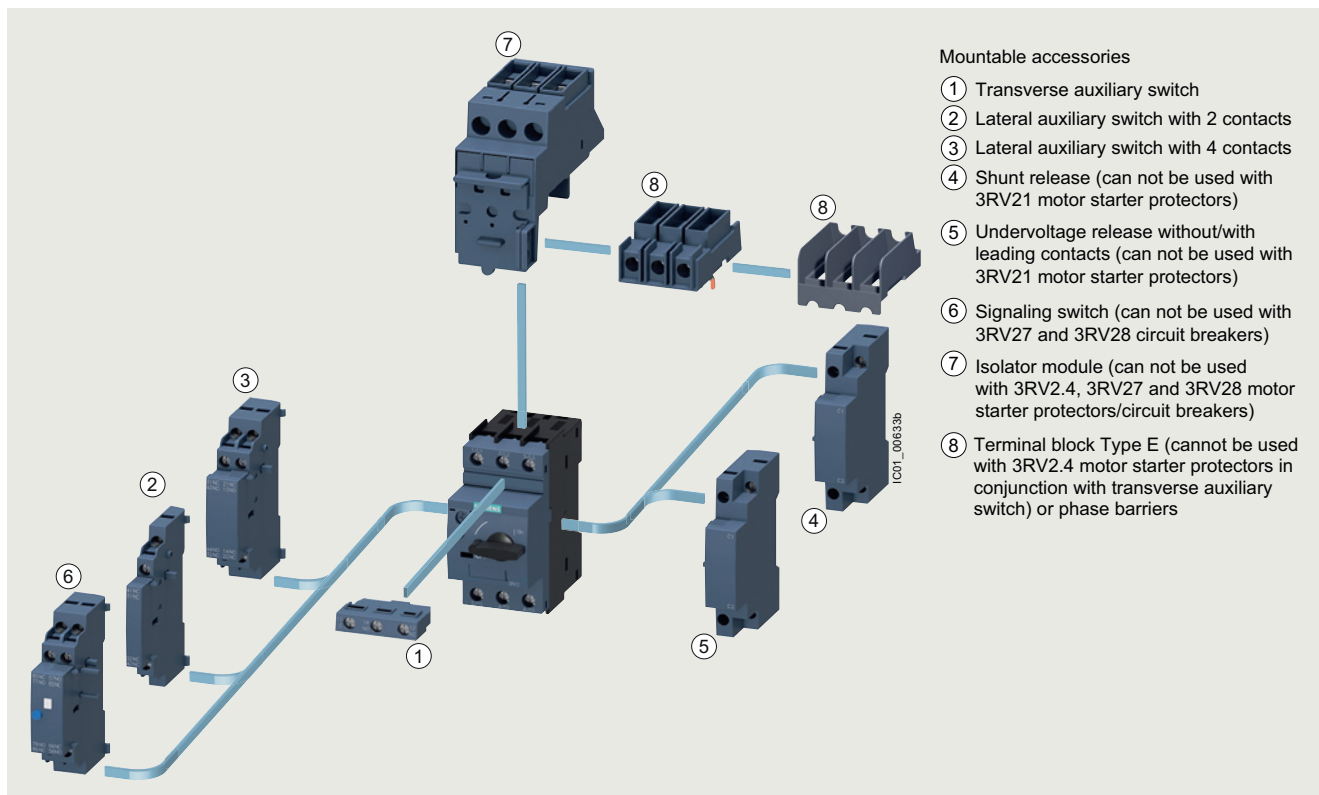

Mountable accessories for SIRIUS 3RV2 motor starter protectors/circuit breakers



Motor starter protector with spring-loaded terminals, size S00 (left) and motor starter protector with screw terminals, size S00 (right)



Video: SIRIUS 3RV2 circuit breakers - Motor protection for machinery and plants (0.11 to 100 A)

The SIRIUS 3RV2 motor starter protectors/circuit breakers are compact, current limiting motor starter protectors/circuit breakers which are optimized for load feeders. The motor starter protectors/circuit breakers are used for switching and protecting three-phase motors of up to 55/45 kW at 400 V AC and for other loads with rated currents of up to 100 A.

3RV2 motor starter protectors are usually approved according to IEC and UL/CSA. According to UL 508/UL 60947-4-1, the 3RV2 motor starter protectors/circuit breakers in sizes S00 to S3 are approved as:

- "Manual Motor Controllers"
- "Manual Motor Controllers" for "Group Installations"
- "Manual Motor Controllers Suitable for Tab Conductor Protection in Group Installations"
- "Self-Protected Combination Motor Controllers (Type E)"
Please note that for this approval the 3RV20 motor starter protectors must be equipped with additional infeed terminals or phase barriers. For more information, see page 7/57.

Corresponding short-circuit values, see pages 7/9 to 7/17.

Protection equipment

Motor starter protectors/circuit breakers

SIRIUS 3RV2 motor starter protectors/circuit breakers

General data

The 3RV2...-.....-0BA0 motor starter protectors/circuit breakers can be used at low ambient temperatures down to -50 °C.

3RV20...-.....-0DA0 motor starter protectors for system protection according to IEC, 3RV24...-.....-0DA0 for transformer protection according to IEC and 3RV27 and 3RV28 circuit breakers according to UL 489 can be used for 1-phase, 2-phase and 3-phase loads, as these motor starter protectors/circuit breakers do not have asymmetry detection.

The 3RV27 and 3RV28 are approved as circuit breakers according to UL 489; they are a special version of the 3RV2 motor starter protectors.

Thanks to their dimensions, the 3RV1011 motor starter protectors are suitable for installation in enclosures or under cramped installation conditions.

Type of construction

The 3RV2 motor starter protectors are available in four sizes:

- Size S00 – width 45 mm, max. rated current 16 A, at 400 V AC suitable for three-phase motors up to 7.5 kW
- Size S0 – width 45 mm, max. rated current 40 A, at 400 V AC suitable for three-phase motors up to 18.5 kW
- Size S2 – width 55 mm, max. rated current 80 A, at 400 V AC suitable for three-phase motors up to 37 kW
- Size S3 – width 70 mm, max. rated current 100 A, at 400 V AC suitable for three-phase motors up to 45/55 kW

Circuit breakers according to UL 489

The 3RV27 and 3RV28 circuit breakers are available in two or three sizes:

- Size S00 – width 45 mm, max. rated current 15 A, for 480 Y/277 V AC
- Size S0 – width 45 mm, max. rated current 22 A, for 480 Y/277 V AC
- Size S3 – width 70 mm, max. rated current 70 A, for 480 Y/277 V AC

Connection methods

The 3RV2 motor starter protectors/circuit breakers can be supplied with screw terminals and spring-loaded terminals.



Screw terminals



Spring-loaded terminals

The terminals are indicated in the corresponding tables by the symbols shown on orange backgrounds.

Voltage data

The data for 3-phase power systems according to IEC 60947-4-1 are valid for the following line system configurations:

Voltage U_e	Line system configurations	
	Three-phase four-wire networks	Three-phase three-wire networks
230	--	230
400	230/400	400
440	260/440	440
500	--	500
690	400/690	690 (only as from size S3)
1 000	--	1 000

-- Not specified

Use in hazardous areas

The 3RV20 motor starter protectors for motor protection (without 3RV20...-.....-0BA0 and -0DA0) have certification in accordance with both the European Explosion Protection Directive (ATEX) and the International Explosion Protection Standard (IECEx).

In accordance with the European Directive (ATEX), the 3RV20 (without 3RV20...-.....-0BA0 and -0DA0) are able to switch and protect explosion-proof motors of type of protection "Increased Safety EEx e".

In accordance with the international guideline (IECEx), the 3RV20 (without 3RV20...-.....-0BA0 and -0DA0) are able to switch and protect motors of the types "Increased Safety Ex e" or "Flameproof enclosure Ex d".

Article number scheme

Product versions	Article number
Motor starter protectors/circuit breakers	3RV2 □ □ □ - □ □ □ □ □ - □ □ □ □
Type of motor starter protector/circuit breaker	e.g. 0 = for motor protection/system protection □
Size	e.g. 1 = 16 A (7.5 kW) for size S00 □
Breaking capacity	e.g. 1 = standard switching capacity □
Setting range for overload release	e.g. 1A = 1.1 ... 1.6 A □ □
Trip class (CLASS)	e.g. A = a (adjustable CLASS 10)/n (13 or 20 x I_n) □
Connection methods	e.g. 1 = screw terminals □
With or without auxiliary switch	e.g. 0 = without □
Special versions	□ □ □ □

Example

3RV2 0 1 1 - 1 A A 1 0

Note:

The article number scheme shows an overview of product versions for better understanding of the logic behind the article numbers.

For your orders, please use the article numbers quoted in the selection and ordering data.

Protection equipment

Motor starter protectors/circuit breakers

SIRIUS 3RV2 motor starter protectors/circuit breakers

General data

Application

Operating conditions

3RV2 motor starter protectors/circuit breakers are suitable for use in any climate. They are intended for use in enclosed rooms in which no severe operating conditions (such as dust, caustic vapors, hazardous gases) prevail. When installed in dusty and damp areas, suitable enclosures must be provided.

3RV2 motor starter protectors/circuit breakers can optionally be fed from the top or from below.

The permissible ambient temperatures, the maximum switching capacities, the tripping currents and other boundary conditions can be found in the technical specifications and tripping characteristics.

3RV2 motor starter protectors/circuit breakers are suitable for operation in IT systems (IT networks). In this case, the different short-circuit breaking capacity in the IT system must be taken into account, [see page 7/11](#).

Since operational currents, starting currents and current peaks are different even for motors with identical power ratings due to the inrush current, the motor ratings in the selection tables are only guide values. The specific rated and startup data of the motor to be protected are always paramount to the choice of the most suitable motor starter protector/circuit breaker. This also applies to motor starter protectors for transformer protection.

Possible uses

The 3RV motor starter protectors/circuit breakers can be used:

- For short-circuit protection
- For motor protection (also with overload relay function)
- For system protection
- For short-circuit protection for starter combinations
- For transformer protection
- As main and EMERGENCY OFF switches
- For operation in IT systems (IT networks)
- In hazardous areas (ATEX, IECEx)
- As circuit breakers according to UL 489 (3RV27 and 3RV28)
- For fuse monitoring
- For distance protection

Use of SIRIUS protection devices in conjunction with IE3 and IE4 motors

Note:

For the use of 3RV2 motor starter protectors/circuit breakers in conjunction with highly efficient IE3 and IE4 motors, please observe the information on dimensioning and configuring, [see Application Manual](#).

For more information, [see page 1/8](#).

Protection equipment

Motor starter protectors/circuit breakers

SIRIUS 3RV2 motor starter protectors/circuit breakers

General data

Technical specifications

More information

System Manual for modular system, see
<https://support.industry.siemens.com/cs/ww/en/view/60311318>
 Configuration Manual for load feeders, see
<https://support.industry.siemens.com/cs/ww/en/view/39714188>

Equipment Manual, see
<https://support.industry.siemens.com/cs/ww/en/view/60279172>
 Technical specifications, see
<https://support.industry.siemens.com/cs/ww/en/ps/16245/td>
 For UL reports for the individual devices, see
<https://support.industry.siemens.com/cs/ww/en/ps/16245/cert>

Short-circuit breaking capacity I_{cu} , I_{cs} according to IEC 60947-2

The table shows the rated ultimate short-circuit breaking capacity I_{cu} and the rated service short-circuit breaking capacity I_{cs} of the 3RV motor starter protectors/circuit breakers with different operational voltages dependent on the rated current I_n of the motor starter protectors/circuit breakers.

Power can be supplied to the motor starter protectors/circuit breakers via the terminals at the top or at the bottom without restricting the rated data. If the short-circuit current at the installation location exceeds the motor starter protector/circuit breaker's specified rated short-circuit breaking capacity, you will need to use a back-up fuse. It is also possible to install

an upstream motor starter protector/circuit breaker with a limiter function.

The maximum rated current of this back-up fuse is indicated in the tables. The rated ultimate short-circuit breaking capacity then applies as specified on the fuse.

Fuseless design

Motor starter protector/contactors assemblies for short-circuit currents up to 150 kA can be ordered as 3RA2 fuseless load feeders, see page 8/5 onwards.

Motor starter protectors/circuit breakers	Rated current I_n	Up to 240 V AC ¹⁾			Up to 400 V AC ¹⁾ /415 V AC ²⁾			Up to 440 V AC ¹⁾ /460 V AC ²⁾			Up to 500 V AC ¹⁾ /525 V AC ²⁾			Up to 690 V AC ¹⁾		
		I_{cu}	I_{cs}	Max. fuse (gG)	I_{cu}	I_{cs}	Max. fuse (gG) ³⁾	I_{cu}	I_{cs}	Max. fuse (gG) ³⁾	I_{cu}	I_{cs}	Max. fuse (gG) ³⁾	I_{cu}	I_{cs}	Max. fuse (gG) ³⁾⁴⁾
Type	A	kA	kA	A	kA	kA	A	kA	kA	A	kA	kA	A	kA	kA	A
Size S00																
3RV1011	0.16 ... 1	100	100	--	100	100	--	100	100	--	100	100	--	100	100	--
	1.25, 1.6	100	100	--	100	100	--	100	100	--	100	100	--	2	2	20
	2; 2.5	100	100	--	100	100	--	100	100	--	10	10	35	2	2	35
	3.2; 4	100	100	--	100	100	--	50	12.5	40	3	3	40	2	2	40
	5; 6.3	100	100	--	100	100	--	50	12.5	50	3	3	50	2	2	40
	8	100	100	--	50	12.5	80	50	12.5	63	3	3	63	2	2	50
	10	100	100	--	50	12.5	80	10	10	63	3	3	63	2	2	50
12	100	100	--	50	12.5	80	10	10	80	3	3	80	2	2	50	
3RV2.11	0.16 ... 1.6	100	100	--	100	100	--	100	100	--	100	100	--	100	100	--
	2; 2.5	100	100	--	100	100	--	100	100	--	100	100	--	10	10	25
	3.2	100	100	--	100	100	--	100	100	--	100	100	--	10	10	32
	4; 5	100	100	--	100	100	--	100	100	--	100	100	--	6	4	32
	6.3	100	100	--	100	100	--	100	100	--	100	100	--	6	4	50
	8	100	100	--	100	100	--	50	50	63	42	42	63	6	4	50
	10	100	100	--	100	100	--	50	50	80	42	42	63	6	4	50
12.5	100	100	--	100	100	--	50	50	80	42	42	80	6	4	63	
16	100	100	--	55	30	100	50	12.5	80	10	5	80	4	4	63	
3RV1611-0BD10	0.2	100	100	--	100	100	--	100	100	--	100	100	--	100	100	--
Size S0																
3RV2.21	0.16 ... 1.6	100	100	--	100	100	--	100	100	--	100	100	--	100	100	--
	2; 2.5	100	100	--	100	100	--	100	100	--	100	100	--	10	10	25
	3.2	100	100	--	100	100	--	100	100	--	100	100	--	10	10	32
	4; 5	100	100	--	100	100	--	100	100	--	100	100	--	6	4	32
	6.3	100	100	--	100	100	--	100	100	--	100	100	--	6	4	50
	8	100	100	--	100	100	--	50	50	63	42	42	63	6	4	50
	10	100	100	--	100	100	--	50	50	80	42	42	63	6	4	50
	12.5	100	100	--	100	100	--	50	50	80	42	42	80	6	4	63
	16	100	100	--	55	25	100	50	12.5	80	10	5	80	4	2	63
	20	100	100	--	55	25	125	50	10	80	10	5	80	4	2	63
	22; 25	100	100	--	55	25	125	50	10	100	10	5	80	4	2	63
	28; 32	100	100	--	55	25	125	30	10	125	10	5	100	4	2	100
	36; 40	100	100	--	20	10	125	12	8	125	6	3	100	3	2	100

-- No back-up fuse required, since short-circuit-proof up to 100 kA

1) 10% overvoltage.

2) 5% overvoltage.

3) Back-up fuse only required if short-circuit current at the installation location is $> I_{cu}$.

4) Alternatively, fuseless limiter combinations for 690 V AC can also be used.

Protection equipment

Motor starter protectors/circuit breakers

SIRIUS 3RV2 motor starter protectors/circuit breakers

General data

Motor starter protectors/ circuit breakers	Rated current I_n	Up to 240 V AC ¹⁾			Up to 400 V AC ^{1)/415 V AC²⁾}			Up to 440 V AC ^{1)/460 V AC²⁾}			Up to 500 V AC ^{1)/525 V AC²⁾}			Up to 690 V AC ¹⁾		
		I_{cu}	I_{cs}	Max. fuse (gG)	I_{cu}	I_{cs}	Max. fuse (gG) ³⁾	I_{cu}	I_{cs}	Max. fuse (gG) ³⁾	I_{cu}	I_{cs}	Max. fuse (gG) ³⁾	I_{cu}	I_{cs}	Max. fuse (gG) ³⁾⁴⁾
Type	A	kA	kA	A	kA	kA	A	kA	kA	A	kA	kA	A	kA	kA	A
Size S2																
3RV2.31	14; 17	100	100	--	65	30	100	50	25	100	12	6	63	5	3	63
	20	100	100	--	65	30	100	50	25	100	12	6	80	5	3	80
	25	100	100	--	65	30	100	50	15	100	12	6	80	5	3	80
	32; 36	100	100	--	65	30	125	50	15	125	10	5	100	4	2	100
	40; 45	100	100	--	65	30	160	50	15	125	10	5	100	4	2	100
	52	100	100	--	65	30	160	50	15	125	10	5	125	4	2	125
	59; 65	100	100	--	65	30	160	50	15	160	8	4	125	4	2	125
	73; 80	100	100	--	65	30	200	50	15	200	8	4	160	4	2	125
Size S2, with increased switching capacity																
3RV2.32	14; 17	100	100	--	100	50	--	65	30	100	18	10	63	8	5	63
	20; 25	100	100	--	100	50	--	65	30	100	18	10	80	8	5	80
	32 ... 45	100	100	--	100	50	--	65	30	125	15	8	100	6	4	100
	52	100	100	--	100	50	--	65	30	125	15	8	125	6	4	125
	59; 65	100	100	--	100	50	--	50	15	160	10	5	125	6	4	125
	73; 80	100	100	--	100	50	--	50	15	200	10	5	160	6	4	125
Size S3																
3RV2.41	40	100	100	--	65	30	125	65	30	125	12	6	100	6	3	63
	50	100	100	--	65	30	125	65	30	125	12	6	100	6	3	80
	63	100	100	--	65	30	160	65	30	160	12	6	100	6	3	80
	75	100	100	--	65	30	160	65	30	160	8	4	125	5	3	100
	84 ... 100	100	100	--	65	30	160	65	30	160	8	4	125	5	3	125
Size S3, with increased switching capacity																
3RV2.42	40	100	100	--	100	50	--	100	50	--	18	9	160	12	6	80
	50	100	100	--	100	50	--	100	50	--	15	7.5	160	10	5	100
	63	100	100	--	100	50	--	70	50	200	15	7.5	160	7.5	4	100
	75	100	100	--	100	50	--	70	50	200	10	5	160	6	3	125
	84 ... 100	100	100	--	100	50	--	70	50	200	10	5	160	6	3	160
3RV2742	10 ... 70	100	100	--	100	50	--	--	--	--	--	--	--	--	--	--

-- No back-up fuse required, since short-circuit-proof up to 100 kA

1) 10% overvoltage.

2) 5% overvoltage.

3) Back-up fuse only required if short-circuit current at the installation location is $> I_{cu}$.

4) Alternatively, fuseless limiter combinations for 690 V AC can also be used.

Protection equipment

Motor starter protectors/circuit breakers

SIRIUS 3RV2 motor starter protectors/circuit breakers

General data

Short-circuit breaking capacity I_{cuIT} in the IT system (IT network) according to IEC 60947-2

3RV motor starter protectors/circuit breakers are suitable for use in IT systems. The values of I_{cu} and I_{cs} apply for the 3-pole short circuit. In the case of a double ground fault in different phases at the input and output side of a motor starter protector/circuit breaker, the special short-circuit breaking capacity I_{cuIT} applies. The specifications in the table below apply to 3RV motor starter protectors/circuit breakers.

If the short-circuit current at the installation location exceeds the motor starter protector/circuit breaker's specified rated short-circuit breaking capacity, you will need to use a back-up fuse. The maximum rated current of this back-up fuse is indicated in the tables. The rated short-circuit breaking capacity then applies as specified on the fuse.

Motor starter protectors/ circuit breakers	Rated current I_n	Up to 240 V AC ¹⁾		Up to 400 V AC ^{1)/415 V AC²⁾}		Up to 440 V AC ^{1)/460 V AC²⁾}		Up to 500 V AC ^{1)/525 V AC²⁾}		Up to 690 V AC ¹⁾³⁾	
		I_{cuIT}	Max. fuse (gG) ⁴⁾	I_{cuIT}	Max. fuse (gG) ⁴⁾⁵⁾	I_{cuIT}	Max. fuse (gG) ⁴⁾	I_{cuIT}	Max. fuse (gG) ⁴⁾	I_{cuIT}	Max. fuse (gG) ⁴⁾
Type	A	kA	A	kA	A	kA	A	kA	A	kA	A
Size S00											
3RV1011	0.16 ... 0.4	100	--	100	--	100	--	100	--	100	--
	0.5	100	--	100	--	100	--	100	--	0.5	4
	0.63	100	--	100	--	6	6	6	6	0.5	6
	0.8	100	--	100	--	5	6	5	6	0.5	6
	1	100	--	4	10	2	10	2	10	0.5	10
	1.25	100	--	2	20	2	16	2	16	0.5	16
	1.6	100	--	2	20	2	20	2	20	1	16
	2	100	--	2	35	2	25	2	25	1	20
	2.5	100	--	2	35	2	25	2	25	1	25
	3.2	100	--	2	40	2	35	2	35	1	25
	4	100	--	2	40	2	35	2	35	1	35
	5	100	--	2	50	2	35	2	35	1	35
	6.3	100	--	2	50	2	40	2	40	1	40
	8	50	80	2	63	2	40	2	40	1	40
	10	50	80	2	63	2	50	2	50	1	50
	12	50	80	2	80	2	50	2	50	1	50
3RV2.11	0.16 ... 0.4	100	--	100	--	100	--	100	--	100	--
	0.5	100	--	100	--	100	--	100	--	0.5	4
	0.63; 0.8	100	--	100	--	100	--	100	--	0.5	6
	1	100	--	100	--	2	10	2	10	1.5	10
	1.25	100	--	100	--	2	16	2	16	1.5	16
	1.6	100	--	100	--	2	20	2	20	1.5	16
	2; 2.5	100	--	8	25	2	25	2	25	1.5	20
	3.2	100	--	8	32	2	32	2	32	1.5	25
	4; 5	100	--	4	32	1.5	32	1.5	32	1.5	25
	6.3; 8	100	--	4	50	1	40	1	40	1	35
	10	100	--	4	50	1	40	1	40	1	40
	12.5	100	--	4	63	1	50	1	50	1	40
	16	55	80	4	63	1	50	1	50	1	40
Size S0											
3RV2.21	0.16 ... 0.4	100	--	100	--	100	--	100	--	100	--
	0.5	100	--	100	--	100	--	100	--	0.5	4
	0.63; 0.8	100	--	100	--	100	--	100	--	0.5	6
	1	100	--	100	--	2	10	2	10	1.5	10
	1.25	100	--	100	--	2	16	2	16	1.5	16
	1.6	100	--	100	--	2	20	2	20	1.5	16
	2; 2.5	100	--	8	25	2	25	2	25	1.5	20
	3.2	100	--	8	32	2	32	2	32	1.5	25
	4; 5	100	--	4	32	1.5	32	1.5	32	1.5	25
	6.3; 8	100	--	4	50	1	40	1	40	1	35
	10	100	--	4	50	1	40	1	40	1	40
	12.5	100	--	4	63	1	50	1	50	1	40
	16	55	80	4	63	1	50	1	50	1	40
	20 ... 25	55	80	4	63	1	50	1	50	1	50
	28; 32	55	80	2	63	1	63	1	63	1	63
	36; 40	20	80	2	63	1	63	1	63	1	63

-- No back-up fuse required, since short-circuit-proof up to 100 kA

¹⁾ 5% overvoltage.

²⁾ Without overvoltage.

³⁾ Overvoltage category II applies for applications in IT systems > 600 V.

⁴⁾ Back-up fuse only required if short-circuit current at installation location is > I_{cuIT} .

⁵⁾ Alternatively, fuseless limiter combinations for 690 V AC can also be used.

Protection equipment

Motor starter protectors/circuit breakers

SIRIUS 3RV2 motor starter protectors/circuit breakers

General data

Motor starter protectors/circuit breakers	Rated current I_n	Up to 240 V AC ¹⁾		Up to 400 V AC ^{1)/415 V AC²⁾}		Up to 440 V AC ^{1)/460 V AC²⁾}		Up to 500 V AC ^{1)/525 V AC²⁾}		Up to 690 V AC ¹⁾³⁾	
		I_{cuIT}	Max. fuse (gG) ⁴⁾	I_{cuIT}	Max. fuse (gG) ⁴⁾⁵⁾	I_{cuIT}	Max. fuse (gG) ⁴⁾	I_{cuIT}	Max. fuse (gG) ⁴⁾	I_{cuIT}	Max. fuse (gG) ⁴⁾
Type	A	kA	A	kA	A	kA	A	kA	A	kA	A
Size S2											
3RV2031, 3RV2131, 3RV2331	14 ... 25	100	--	8	100	6	80	6	80	4	63
	32 ... 45	100	--	6	125	4	100	4	100	3	80
	52 ... 80	100	--	4	160	3	125	3	125	2	100
Size S2, with increased switching capacity											
3RV2032, 3RV2332	14 ... 25	100	--	8	100	6	80	6	80	4	63
	32 ... 45	100	--	6	125	6	100	6	100	4	80
	52	100	--	6	160	6	125	6	125	4	100
	59 ... 80	100	--	6	160	4	125	4	125	4	100
Size S3											
3RV2.41	40	65	125	10	63	5	50	5	50	5	50
	50	65	125	8	80	3	63	3	63	3	63
	63	65	160	6	80	3	63	3	63	3	63
	75	65	160	5	100	2	80	2	80	2	80
	84; 100	65	160	5	125	2	100	2	100	2	100
Size S3, with increased switching capacity											
3RV2.42	40	100	--	12	80	6	63	6	63	6	63
	50	100	--	10	100	4	80	4	80	4	80
	63	100	--	7.5	100	4	80	4	80	4	80
	75	100	--	6	125	3	100	3	100	3	100
	84; 100	100	--	6	160	3	125	3	125	3	125

-- No back-up fuse required, since short-circuit-proof up to 100 kA

1) 10% overvoltage.

2) 5% overvoltage.

3) Overvoltage category II applies for applications in IT systems > 600 V.

4) Back-up fuse only required if short-circuit current at installation location is > I_{cuIT} .

5) Alternatively, fuseless limiter combinations for 690 V AC can also be used.

Protection equipment

Motor starter protectors/circuit breakers

SIRIUS 3RV2 motor starter protectors/circuit breakers

General data

Limiting function with standard devices for 500 V AC and 690 V AC according to IEC 60947-2

The table shows the rated ultimate short-circuit breaking capacity I_{cu} and the rated service short-circuit breaking capacity I_{cs} with an upstream standard motor starter protector/circuit breaker that fulfills the limiter function at voltages 500 V AC and 690 V AC.

The short-circuit breaking capacity can be increased significantly with an upstream standard motor starter protector/circuit breaker with limiter function. The motor starter protector/circuit breaker which is connected downstream must be set to the rated current of the load.

With motor starter protector/circuit breaker assemblies, note the clearance to grounded parts and between the motor starter protectors/circuit breakers. Short-circuit-proof wiring between the motor starter protectors/circuit breakers must be ensured. The motor starter protectors/circuit breakers can be mounted side by side in a modular arrangement.

Standard motor starter protectors/circuit breakers		Rated current I_n A	Up to 500 V AC ¹⁾ /525 V AC ²⁾		Up to 690 V AC ¹⁾³⁾	
With limiter Rated current I_n			I_{cu} kA	I_{cs} kA	I_{cu} kA	I_{cs} kA
Type	Type					
Size S00						
Size S0: 3RV2321-4EC10 $I_n = 32$ A	3RV2011	2 ... 6.3 8 10 ... 16	-- 100 100	-- 50 50	50 50 20 ⁴⁾	25 25 10 ⁴⁾
Size S2: 3RV2331-4WC10 $I_n = 52$ A	3RV2011	10 ... 16	--	--	50	25
Size S0						
Size S0: 3RV2321-4EC10 $I_n = 32$ A	3RV2021	12 ... 32	100	50	20 ⁴⁾	10 ⁴⁾
Size S2: 3RV2331-4WC10 $I_n = 52$ A	3RV2021	16 ... 32	--	--	50	20
Size S2, with increased switching capacity						
Size S2: 3RV2332-4RC10 $I_n = 80$ A	3RV2032	14 ... 80	100	50	70	35
Size S3, with increased switching capacity						
Size S3⁵⁾: 3RV2342-4MC10 $I_n = 100$ A	3RV2042	40 ... 100	100	50	50	25

-- No limiter required

1) 10% overvoltage.

2) 5% overvoltage.

3) Use 3RV29.8-1K phase barriers on the infeed side

4) Infeed to the limiter is always on the side 1L1/3L2/5L3.

5) Infeed to the limiter only on the side 2T1/4T2/6T3. Use 3RV2948-1K phase barriers on the infeed side.

Protection equipment

Motor starter protectors/circuit breakers

SIRIUS 3RV2 motor starter protectors/circuit breakers

General data

Permissible rated data of devices approved for North America (UL/CSA)

Motor starter protectors of the 3RV2 series are approved for UL/CSA, and according to UL 508/UL 60947-4-1 and CSA C22.2 No. 14/CSA C22.2 No. 60947-4-1 they can be used on their own or as load feeders in combination with a contactor.

These motor starter protectors/circuit breakers can be used as "Manual Motor Controllers" for "Group Installations", as "Manual Motor Controllers Suitable for Tap Conductor Protection in Group Installations" and as "Self-Protected Combination Motor Controllers (Type E)".

3RV motor starter protectors as "Manual Motor Controllers"

If used as a "Manual Motor Controller", the motor starter protector is always operated in combination with an upstream short-circuit protection. Approved fuses or circuit breakers according to UL 489/CSA C22.2 No. 5 may be used for this purpose. These devices must be dimensioned according to the National Electrical Code (UL) or Canadian Electrical Code (CSA).

The file numbers for the approval of the 3RV as a manual motor controller are as follows:

- UL File No. 47705, CCN: NLRV
- CSA Master Contract 165071, Product Class: 3211

Motor starter protectors/ circuit breakers	V	hp rating ¹⁾ for FLA ²⁾ max.		Rated current I_n A	240 V AC		480 V AC		600 V AC	
		1-phase	3-phase		UL	CSA	UL	CSA	UL	CSA
					$I_{bc}^{3)}$ kA	$I_{bc}^{3)}$ kA	$I_{bc}^{3)}$ kA	$I_{bc}^{3)}$ kA	$I_{bc}^{3)}$ kA	$I_{bc}^{3)}$ kA
Size S00										
3RV1011										
				0.16 ... 2	65	65	65	65	10	10
FLA ²⁾ max. 12 A, 600 V	115	1/2	--	2.5	65	65	65	65	10	10
	200	1 1/2	3	3.2	65	65	65	65	10	10
	230	2	3	4	65	65	65	65	10	10
	460	--	7 1/2	5	65	65	65	65	10	10
	575/600	--	10	6.3	65	65	65	65	10	10
				8	65	65	65	65	10	10
				10	65	65	65	65	10	10
				12	65	65	65	65	10	10
3RV2011, 3RV2111, 3RV2311, 3RV2411										
				0.16 ... 12.5	65	65	65	65	30	30
FLA ²⁾ max. 16 A, 480 V	115/120	1	2	16	65	65	65	65	--	--
12.5 A, 600 V	200/208	2	3							
	230/240	2	5							
	460/480	--	10							
	575/600	--	10							
3RV1611-0BD10										
				0.2	65	65	65	65	10	10
Size S0										
3RV2021, 3RV2121, 3RV2321, 3RV2421										
				0.16 ... 12.5	65	65	65	65	30	30
FLA ²⁾ max. 40 A, 480 V	115/120	3	5	16 ... 25	65	65	65	65	--/(30) ⁴⁾	--/(30) ⁴⁾
12.5 A, 600 V	200/208	5	10	28, 32	65	65	50	50	--	--
	230/240	7 1/2	10	36, 40	65	65	12	12	--	--
	460/480	--	30							
	575/600	--	--							
Size S2										
3RV2031, 3RV2131, 3RV2331, 3RV2431										
				14 ... 36	65	65	65	65	25	25
FLA ²⁾ max. 80 A, 600 V	115/120	7 1/2	10	40 ... 52	65	65	65	65	22	22
	200/208	15	25	59 ... 65	65	65	65 ⁵⁾	65 ⁵⁾	20 ⁵⁾	20 ⁵⁾
	230/240	15	30	73 ... 80	65	65	65 ⁵⁾	65 ⁵⁾	20 ⁵⁾	20 ⁵⁾
	460/480	--	60							
	575/600	--	75							
Size S2, with increased switching capacity										
3RV2032, 3RV2332										
				14 ... 36	100	100	100	100	25	25
FLA ²⁾ max. 80 A, 600 V	115/120	7 1/2	10	40 ... 52	100	100	100	100	22	22
	200/208	15	25	59 ... 65	100	100	100 ⁵⁾	100 ⁵⁾	25 ⁵⁾	25 ⁵⁾
	230/240	15	30	73 ... 80	100	100	100 ⁵⁾	100 ⁵⁾	25 ⁵⁾	25 ⁵⁾
	460/480	--	60							
	575/600	--	75							
Size S3										
3RV2041, 3RV2142, 3RV2341, 3RV2042, 3RV2342										
				40 ... 75	65	65	65	65	30	30
FLA ²⁾ max. 100 A, 600 V	115/120	7 1/2	15	84 ... 100	65	65	65	65	10/30 ⁶⁾	10/30 ⁶⁾
	200/208	15	30							
	230/240	20	40							
	460/480	--	75							
	575/600	--	100							

-- No approval

¹⁾ hp rating = Power rating in horse power (maximum motor rating).

²⁾ FLA = Full Load Amps (motor full load current).

³⁾ Corresponds to "short-circuit breaking capacity" according to UL/CSA.

⁴⁾ Values in brackets only apply to 3RV2.23 motor starter protectors.

⁵⁾ With Class J fuse.

⁶⁾ With Class J fuse 300 A.

Protection equipment

Motor starter protectors/circuit breakers

SIRIUS 3RV2 motor starter protectors/circuit breakers

General data

3RV20 motor starter protectors (up to 100 A) as "Manual Motor Controllers Suitable for Tap Conductor Protection in Group Installations"

The application as "Manual Motor Controllers Suitable for Tap Conductor Protection in Group Installations" is only available for UL. CSA does not recognize this approval! When the motor starter protector is used as a "Manual Motor Controller Suitable for Tap Conductor Protection in Group Installations", it must always be combined with upstream short-circuit protection. Approved fuses or circuit breakers according to UL 489 may be used for this purpose. These devices must be dimensioned according to the National Electrical Code.

The 3RV20 motor starter protectors are approved as "Manual Motor Controllers Suitable for Tap Conductor Protection in Group Installations" under the following file number:

- UL File No. 47705, CCN: NLRV

Motor starter protectors/ circuit breakers		hp rating ¹⁾ for FLA ²⁾ max.		Rated current I_n A	240 V AC	480 Y/277 V AC	600 Y/347 V AC
		1-phase	3-phase		UL $I_{bc}^{(3)}$ kA	UL $I_{bc}^{(3)}$ kA	UL $I_{bc}^{(3)}$ kA
Type	V						
Size S00							
3RV1011							
FLA ²⁾ max. 8 A, 480 V	115 200 230 460 575/600	1/3 3/4 1 -- --	-- 2 2 5 --	0.16 ... 0.8 1 1.25 2 2.5 3.2 4 5 6.3 8	65 65 65 65 65 65 65 65 65 65	65 65 65 65 65 65 65 65 65 65	10 10 10 10 10 10 10 10 10 10
3RV2011							
FLA ²⁾ max. 16 A, 480 V 12.5 A, 600 V	115/120 200/208 230/240 460/480 575/600	1 2 2 -- --	2 3 5 10 10	0.16 ... 12.5 16	65 65	65 65	30 --
Size S0							
3RV2021							
FLA ²⁾ max. 32 A, 480 V 12.5 A, 600 V	115/120 200/208 230/240 460/480 575/600	2 3 5 -- --	5 10 10 20 --	0.16 ... 12.5 16 ... 25 28; 32	65 65 50	65 65 50	30 -- --
Size S2							
3RV2031							
FLA ²⁾ max. 80 A, 480 V 52 A, 600 V	115/120 200/208 230/240 460/480 575/600	7 1/2 15 15 -- --	10 25 30 60 75	14 ... 36 40 ... 52 59 ... 65 73 80	65 65 65 65 65	65 65 30 20 10	25 22 -- -- --
Size S2, with increased switching capacity							
3RV2032							
FLA ²⁾ max. 80 A, 480 V 52 A, 600 V	115/120 200/208 230/240 460/480 575/600	7 1/2 15 15 -- --	10 25 30 60 75	14 ... 36 40 ... 52 59 ... 65 73 80	100 100 100 100 100	100 100 42 30 10	25 22 -- -- --
Size S3							
3RV2041, 3RV2042							
FLA ²⁾ max. 100 A, 480 V 75 A, 600 V	115/120 200/208 230/240 460/480 575/600	7 1/2 15 20 -- --	15 30 40 75 75	40 ... 75 84 ... 100	65 65	65 65	30 --

-- No approval

¹⁾ hp rating = Power rating in horse power (maximum motor rating).

²⁾ FLA = Full Load Amps (motor full load current).

³⁾ Corresponds to "short-circuit breaking capacity" according to UL.

Protection equipment

Motor starter protectors/circuit breakers

SIRIUS 3RV2 motor starter protectors/circuit breakers

General data

3RV20 motor starter protectors (up to 100 A) as "Self-Protected Combination Motor Controllers (Type E)"

UL 508/UL 60947-4-1 approval demands 1-inch clearance and 2-inch creepage distance at line side for "Self-Protected Combination Motor Controllers".

Therefore, 3RV20 motor starter protectors of sizes S00 to S3 are approved according to UL 508/UL 60947-4-1 in combination with the terminal blocks listed below.

CSA does not require these extended clearance and creepage distances. According to CSA, these terminal blocks can be

omitted when the device is used as a "Self-Protected Combination Motor Controller".

The 3RV20 motor starter protectors are approved as "Self-Protected Combination Motor Controllers" under the following file numbers:

- UL File No. E156943, CCN: NKJH
- CSA Master Contract 165071, Product Class: 3211 08

Motor starter protectors/circuit breakers	hp rating ¹⁾ for FLA ²⁾ max.		Rated current I_n A	Up to 240 V AC		Up to 480 Y/277 V AC		Up to 600 Y/347 V AC		
	V	1-phase		3-phase	UL	CSA	UL	CSA	UL	CSA
					$I_{bc}^{3)}$ kA	$I_{bc}^{3)}$ kA	$I_{bc}^{3)}$ kA	$I_{bc}^{3)}$ kA	$I_{bc}^{3)}$ kA	$I_{bc}^{3)}$ kA
Size S00										
3RV2011 + 3RV2928-1H⁴⁾				0.16 ... 12.5 16	65 65	65 65	65 65	65 65	30 --	30 --
FLA ²⁾ max.	115/120	1	2							
16 A, 480 V;	200/208	2	3							
12.5 A, 600 V	230/240	2	5							
	460/480	--	10							
	575/600	--	10							
Size S0										
3RV2021 + 3RV2928-1H⁴⁾				0.16 ... 12.5 16 ... 25 28; 32	65 65 50	65 65 50	65 65 50	65 65 50	30 -- --	30 -- --
FLA ²⁾ max.	115/120	2	5							
32 A, 480 V	200/208	3	10							
12.5 A, 600 V	230/240	5	10							
	460/480	--	20							
	575/600	--	--							
Size S2										
3RV2031+ 3RV2938-1K⁴⁾				14 ... 36 40 ... 52 59 ... 73	65 65 65	65 65 65	65 65 20	65 65 20	25 22 --	25 22 --
FLA ²⁾ max.	115/120	7 1/2	10							
73 A, 480 V	200/208	15	25							
52 A, 600 V	230/240	15	30							
	460/480	--	60							
	575/600	--	75							
Size S2, with increased switching capacity										
3RV2032 + 3RV2938-1K⁴⁾				14 ... 36 40 ... 52 59 ... 73	100 100 100	100 100 100	100 100 30	100 100 30	25 22 --	25 22 --
FLA ²⁾ max.	115/120	7 1/2	10							
73 A, 480 V	200/208	15	25							
52 A, 600 V	230/240	15	30							
	460/480	--	60							
	575/600	--	75							
Size S3										
3RV2041/3RV2042 + 3RT2946-4GA07⁴⁾				40 ... 75 84 ... 100	65 65	65 65	65 65	65 65	30 --	30 --
FLA ²⁾ max.	115/120	7 1/2	15							
100 A, 480 V	200/208	15	30							
75 A, 600 V	230/240	20	40							
	460/480	--	75							
	575/600	--	75							

-- No approval

¹⁾ hp rating = Power rating in horse power (maximum motor rating).

²⁾ FLA = Full Load Amps (motor full load current).

³⁾ Corresponds to "short-circuit breaking capacity" according to UL/CSA.

⁴⁾ Not required for CSA.

⁵⁾ Alternatively 3RV2928-1K phase barrier can be used.

Protection equipment

Motor starter protectors/circuit breakers

SIRIUS 3RV2 motor starter protectors/circuit breakers

General data

3RV27 and 3RV28 motor starter protectors as "circuit breakers"

These motor starter protectors are approved as circuit breakers according to UL 489 and CSA 22.2 No. 5. They can be used therefore as upstream short-circuit protective devices for "Manual Motor Controllers" and "Manual Motor Controllers Suitable for Tap Conductor Protection in Group Installations".

3RV27 and 3RV28 motor starter protectors are approved as "circuit breakers" under the following file numbers:

- UL File No. E235044, CCN: DIVQ
- CSA Master Contract 165071, Product Class: 1432 01

Motor starter protectors/ circuit breakers	Rated current I_n	240 V AC		480 Y/277 V AC		480 V AC		600 Y/347 V AC		600 V AC	
		UL	CSA	UL	CSA	UL	CSA	UL	CSA	UL	CSA
		$I_{bc}^{1)}$	$I_{bc}^{1)}$	$I_{bc}^{1)}$	$I_{bc}^{1)}$	$I_{bc}^{1)}$	$I_{bc}^{1)}$	$I_{bc}^{1)}$	$I_{bc}^{1)}$	$I_{bc}^{1)}$	$I_{bc}^{1)}$
Type	A	kA	kA	kA	kA	kA	kA	kA	kA	kA	kA
Size S00											
3RV2711	0.16 ... 12.5 15	65	65	65	65	--	--	10	10	--	--
3RV2811	0.16 ... 12.5 15	65	65	65	65	--	--	10	10	--	--
Size S0											
3RV2721	20; 22	50	50	50	50	--	--	--	--	--	--
3RV2821	20; 22	50	50	50	50	--	--	--	--	--	--
Size S3											
3RV2742	10; 15 20 ... 30 35 ... 60 70	65	65	65	65	65	65	20	20	20	20
		65	65	65	65	65	65	20	20	--	--
		65	65	65	65	--	--	20	20	--	--
		65	65	65	65	--	--	10	10	--	--

-- No approval

¹⁾ Corresponds to "short-circuit breaking capacity" according to UL.

Protection equipment

Motor starter protectors/circuit breakers

SIRIUS 3RV2 motor starter protectors/circuit breakers

General data

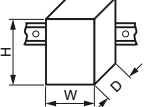
General data		3RV2.1.	3RV2.2.	3RV2.3.	3RV2.4.	3RV27, 3RV28
Type		S00	S0	S2	S3	S00, S0
Size						
Dimensions (W x H x D)	mm	45 x 97 x 92	45 x 97 x 92	55 x 140 x 149	70 x 165 x 169	45 x 144 x 92
• Screw terminals		45 x 106 x 92	45 x 119 x 92	--	--	--
• Spring-loaded terminals						
Standards		Yes	Yes	Yes	Yes (not for 3RV2...-.....-0BA0 and -0DA0 motor starter protectors)	--
• IEC 60947-1 (VDE 0660 Part 100)		Yes	Yes	Yes	Yes	--
• IEC 60947-2 (VDE 0660 Part 101)		Yes	Yes	Yes	Yes	--
• IEC 60947-4-1 (VDE 0660 Part 102)		Yes	Yes	Yes	Yes	--
• UL 508/UL 60947-4-1, CSA C22.2 No. 14/CSA C22.2 No. 60947-4-1		Yes	Yes	Yes	Yes	--
• UL 489, CSA C22.2 No. 5		--	--	--	--	Yes
Number of poles		3				
Max. rated current $I_{n \max}$ (= max. rated operational current I_e)	A	16	40	80	100	22
Permissible ambient temperature						
• Storage/transport	°C	-50 ... +80				
• Operation	°C	-20 (-50) ¹⁾ ... +70 (current reduction above +60 °C)				
I_n : 0.16 ... 32 A	°C	--				
I_n : 36 ... 40 A	°C	--				
		-20 ... +40 (the devices must not be mounted side-by-side and they must not be assembled with link modules with contactors. A lateral clearance of 9 mm is required.)				
I_n : 14 ... 80 A	°C	--				
I_n : 40 ... 100 A	°C	--				
		-20 (-50) ¹⁾ ... +70 (current reduction above +60 °C)				
		-20 ... +70 (current reduction above +60 °C)				
Permissible rated current at inside temperature of control cabinet						
• +60 °C	%	100				
• +70 °C	%	87				
Permissible rated current at ambient temperature of enclosure (applies to motor starter protector/circuit breaker inside enclosure: S00/S0 ≤ 32 A, S2 ≤ 52 A)						
• +35 °C	%	100				
• +60 °C	%	--				
Rated operational voltage U_e						
• According to IEC	V AC	690 (when a molded-plastic enclosure is used only 500 V)				
• According to UL/CSA	V AC	600				
Rated frequency	Hz	50/60				
Rated insulation voltage U_i	V	690			1 000	690
Rated impulse withstand voltage U_{imp}	kV	6			8	6
Utilization category						
• IEC 60947-2 (motor starter protector/circuit breaker)	A	A				
• IEC 60947-4-1 (motor starter)		AC-3 and AC-3e				
Trip class CLASS	According to IEC 60947-4-1	10		10/20		--
Power loss P_v per motor starter protector						
dependent upon rated current I_n (upper setting range)						
I_n : 0.16 ... 0.63 A	W	5.5				
I_n : 0.8 ... 6.3 A	W	7.3				
I_n : 8 ... 16 A	W	9.3				
I_n : 14 ... 16 A	W	--	9.3	12.5	--	9.3
I_n : 17 ... 25 A	W	--	10.5	14.5	--	10.5
I_n : 28 ... 32 A	W	--	13.3	18	--	--
I_n : 36 ... 40 A	W	--	16.3	20	--	--
I_n : 45 ... 52 A	W	--	--	24.5	--	--
I_n : 59 ... 65 A	W	--	--	26	--	--
I_n : 73 ... 80 A	W	--	--	29.5	--	--
I_n : 40 ... 50 A	W	--	--	--	27	--
I_n : 63 ... 75 A	W	--	--	--	38	--
I_n : 84 ... 93 A	W	--	--	--	39	--
I_n : 100 A	W	--	--	--	44	--
Shock resistance	According to IEC 60068-2-27	g/ms 25/11 (square and sine pulse)				



¹⁾ Value in brackets applies to the 3RV2...-.....-0BA0 motor starter protectors.

Protection equipment

Motor starter protectors/circuit breakers

SIRIUS 3RV2 motor starter protectors/circuit breakers

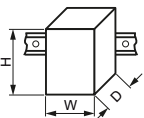
General data

General data (continued)		3RV2.1.	3RV2.2.	3RV2.3.	3RV2.4.	3RV27, 3RV28	
Type		S00	S0	S2	S3	S00, S0	
Size							
Dimensions (W x H x D)		mm	45 x 97 x 92	45 x 97 x 92	55 x 140 x 149	70 x 165 x 169	45 x 144 x 92
• Screw terminals • Spring-loaded terminals		mm	45 x 106 x 92	45 x 119 x 92	--	--	--
Degree of protection IP on the front	according to IEC 60529	IP20 (screw terminals and spring-loaded terminals)					
Touch protection on the front	according to IEC 60529	Finger-safe for vertical touching from the front (screw and spring-loaded terminals)					
Temperature compensation	According to IEC 60947-4-1 °C	-20 ... +60					
Phase failure sensitivity	According to IEC 60947-4-1	Yes (not for 3RV23, 3RV2...-...-0DA0 motor starter protectors)				No	
Protection of motors in hazardous environments		Yes (only for 3RV20 motor starter protectors, not for 3RV20...-...-0BA0 and -0DA0) DMT 02 ATEX F 001  II (2) GD				No	
• EC type-examination certificate number according to European Directive 2014/34/EU (ATEX) • According to international standard IECEx		IECEx BVS14.0102 [Ex]				No	
Isolating function	According to IEC 60947-2	Yes					
Main and EMERGENCY STOP switch characteristics (with corresponding accessories)	According to IEC 60204-1 (VDE 0113)	Yes					
Protective separation between main and auxiliary circuits required for PELV applications	According to IEC 60947-1						
• Up to 400 V + 10% • Up to 415 V + 5% (higher voltages on request) • Up to 690 V (depends on mounted accessories)		Yes Yes Yes, see certificate					
Permissible mounting position		Any, according to IEC 60447 start command "I" right-hand side or top					
Mechanical endurance (operating cycles)							
• 3RV2		100 000		Up to 52 A: 50 000, up to 80 A: 20 000	25 000	100 000	
• 3RV2...-...-0BA0		500		250	--		
Electrical endurance (operating cycles)							
• 3RV2		100 000		Up to 52 A: 50 000, up to 80 A: 20 000	25 000	100 000	
• 3RV2...-...-0BA0		500		250	--		
Max. switching frequency per hour (motor starts)	1/h	15					

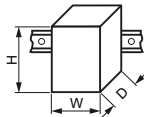
General data		3RV2742	3RV1611-0BD10 ¹⁾	3RV1011	
Type		S3	S00	S00	
Size					
Dimensions (W x H x D)		mm	70 x 168 x 169	45 x 90 x 70	45 x 90 x 70
Standards					
• IEC 60947-1 (VDE 0660 Part 100)		Yes			
• IEC 60947-2 (VDE 0660 Part 101)		Yes			
• UL 508/UL 60947-4-1, CSA C22.2 No. 14/CSA 60947-4-1		No	Yes		
• UL 489, CSA C22.2 No. 5		Yes	No		
Number of poles		3			
Max. rated current $I_{n \max}$ (= max. rated operational current I_e)	A	70	0.2	12	
Permissible ambient temperature					
• Storage/transport	°C	-50 ... +80			
• Operation	°C	-20 ... +70 (current reduction above +60 °C)			
Permissible rated current at inside temperature of control cabinet					
• +60 °C	%	100			
• +70 °C	%	87			
Permissible rated current at ambient temperature of enclosure (applies to motor starter protector/circuit breaker inside enclosure)					
• +35 °C	%	--			
• +60 °C	%	--			
Rated operational voltage U_e					
• According to IEC	V AC	690 (with molded-plastic enclosure 500 V)			
• According to UL/CSA	V AC	600			
Rated frequency	Hz	50/60			
Rated insulation voltage U_i	V	1 000		690	
Rated impulse withstand voltage U_{imp}	kV	8		6	
Utilization category					
• IEC 60947-2 (motor starter protector/circuit breaker)		A			
• IEC 60947-4-1 (motor starter)		AC-3			
		AC-3 and AC-3e			

¹⁾ "Technical specifications" for 3RV1611 voltage transformer circuit breakers, [see page 7/24](#).

Protection equipment

Motor starter protectors/circuit breakers

SIRIUS 3RV2 motor starter protectors/circuit breakers

General data

General data (continued)

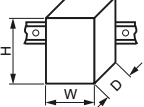
Type			3RV2742	3RV1611-0BD10 ¹⁾	3RV1011
Size			S3	S00	S00
Dimensions (W x H x D)		mm	70 x 168 x 169	45 x 90 x 70	45 x 90 x 70
Power loss P_V per motor starter protector	$I_n: 0.2 \text{ A}$	W	--	5	--
dependent upon	$I_n: 10 \text{ A}$	W	10	--	
rated current I_n	$I_n: 15 \dots 35 \text{ A}$	W	14	--	
(upper setting range)	$I_n: 40 \dots 70 \text{ A}$	W	23.5	--	
$R_{\text{per conducting path}} = \frac{P}{I^2 \times 3}$	$I_n: \dots 1.25 \text{ A}$	W	--		5.5
	$I_n: 1.65 \dots 6.3 \text{ A}$	W	--		7.3
	$I_n: 8 \dots 12 \text{ A}$	W	--		9.3
Shock resistance	According to IEC 60068-2-27	g/ms	25/11 (square and sine pulse)		
Degree of protection IP on the front	according to IEC 60529		IP20		
Touch protection on the front	according to IEC 60529		Finger-safe for vertical touching from the front		
Temperature compensation	According to IEC 60947-4-1	°C	-20 ... +60		
Phase failure sensitivity	According to IEC 60947-4-1		No	Yes	
Explosion protection – Safe operation of motors with "increased safety" type of protection			No		Yes
EC type-examination certificate number according to Directive 2014/34/EU (ATEX)					
Isolating function	According to IEC 60947-2		Yes		
Main and EMERGENCY STOP switch characteristics (with corresponding accessories)	According to IEC 60204-1 (VDE 0113)		Yes		
Protective separation between main and auxiliary circuits, required for PELV applications	According to IEC 60947-1		Yes		
<ul style="list-style-type: none"> • Up to 400 V + 10% • Up to 415 V + 5% (higher voltages on request) 					
Permissible mounting position			Any, according to IEC 60447 start command "I" right-hand side or top		
Mechanical endurance		Operating cycles	25 000	100 000	
Electrical endurance		Operating cycles	25 000	100 000	
Max. switching frequency per hour (motor starts)		1/h	15		

¹⁾ "Technical specifications" for 3RV1611 voltage transformer circuit breakers, see page 7/24.

Rated data of the auxiliary switches and signaling switches

			Lateral auxiliary switch with 1 NO + 1 NC, 2 NO, 2 NC, 2 NO + 2 NC	Signaling switch	Transverse auxiliary switch with 1 CO	1 NO + 1 NC, 2 NO
Max. rated voltage		V AC	600		250	
• According to NEMA (UL)		V AC	600		250	
• According to NEMA (CSA)						
Uninterrupted current		A	10		5	2.5
Switching capacity			1 NO + 1 NC, 2 NO, 2 NC; A600, Q300; 2 NO + 2 NC; A300, Q300	A600, Q300	B600, R300	C300, R300

Protection equipment

Motor starter protectors/circuit breakers

SIRIUS 3RV2 motor starter protectors/circuit breakers

General data

Front transverse auxiliary switches

		Switching capacity for different voltages		
		1 CO	1 NO + 1 NC, 2 NO	
Rated operational current I_e				
• At AC-15, alternating voltage	- 24 V	A	4	2
	- 230 V	A	3	0.5
• At AC-12 = I_{th} , alternating voltage	- 24 V	A	10	2.5
	- 230 V	A	10	2.5
• At DC-13, direct voltage L/R 200 ms	- 24 V	A	1	1
	- 48 V	A	--	0.3
	- 60 V	A	--	0.15
	- 110 V	A	0.22	--
	- 220 V	A	0.1	--
	- 220 V	A	0.1	--
Minimum load capacity		V	17	
		mA	1	

Front transverse solid-state compatible auxiliary switches

		Switching capacity for different voltages	
		1 CO	
Rated operational voltage U_e	Alternating voltage	V	125
Rated operational current $I_e/AC-14$	at $U_e = 125$ V	A	0.1
Rated operational voltage U_e	Direct voltage L/R 200 ms	V	60
Rated operational current $I_e/DC-13$	at $U_e = 60$ V	A	0.3
Minimum load capacity		V	5
		mA	1

Lateral auxiliary switches with signaling switch

		Switching capacity for different voltages: Lateral auxiliary switch with 1 NO + 1 NC, 2 NO, 2 NC, 2 NO + 2 NC, Signaling switch	
Rated operational current I_e			
• At AC-15, alternating voltage	- 24 V	A	6
	- 230 V	A	4
	- 400 V	A	3
	- 690 V	A	1
• At AC-12 = I_{th} , alternating voltage	- 24 V	A	10
	- 230 V	A	10
	- 400 V	A	10
	- 690 V	A	10
	- 690 V	A	10
• At DC-13, direct voltage L/R 200 ms	- 24 V	A	2
	- 110 V	A	0.5
	- 220 V	A	0.25
	- 220 V	A	0.1
	- 440 V	A	0.1
Minimum load capacity		V	17
		mA	1

Auxiliary releases

		Undervoltage releases		Shunt releases	
Power consumption					
• During pick-up	- AC voltages	VA/W	20.2/13	13 ... 80	
	- DC voltages	W	20		
• During uninterrupted duty	- AC voltages	VA/W	7.2/2.4	--	--
	- DC voltages	W	2.1	--	--
Response voltage					
• Tripping	V		0.35 ... 0.7 × U_s	0.7 ... 1.1 × U_s	
• Pick-up	V		0.85 ... 1.1 × U_s	--	
Opening time maximum	ms		20		

Short-circuit protection for auxiliary and control circuits



Melting fuses operational class gG	A	10
Miniature circuit breakers C characteristic	A	6 (prospective short-circuit current < 0.4 kA)

Protection equipment

Motor starter protectors/circuit breakers

SIRIUS 3RV2 motor starter protectors/circuit breakers

General data

Conductor cross-sections of main circuit						
Type		3RV2.11	3RV2.21	3RV2.31-4B.1., 3RV2.31-4D.1., 3RV2.31-4E.1., 3RV2.31-4P.1., 3RV2.31-4S.1., 3RV2.31-4T.1., 3RV2.31-4U.1., 3RV2.31-4V.1.	3RV2.31-4J.1., 3RV2.31-4K.1., 3RV2.31-4R.1., 3RV2.31-4W.1., 3RV2.31-4X.1., 3RV2431-4VA1., 3RV2.32	3RV27.1, 3RV28.1
Size		S00	S0	S2		S00, S0
Connection type		 Screw terminals				
Terminal screw		M3, Pozidriv size 2	M4, Pozidriv size 2	M6, Pozidriv size 2		M4, Pozidriv size 2
Operating devices	mm	∅ 5 ... 6	∅ 5 ... 6	∅ 5 ... 6		∅ 5 ... 6
Prescribed tightening torque	Nm	0.8 ... 1.2	2 ... 2.5	3.0 ... 4.5		2.5 ... 3
Conductor cross-sections (min./max.), one or two conductors can be connected						
• Solid or stranded	mm ²	2 x (0.75 ... 2.5) ¹⁾ , 2 x 4	2 x (1 ... 2.5) ¹⁾ , 2 x (2.5 ... 10) ¹⁾	2 x (1 ... 25) ¹⁾ , 1 x (1 ... 35) ¹⁾	2 x (1 ... 35) ¹⁾ , 1 x (1 ... 50) ¹⁾	2 x (1 ... 10) ¹⁾ , max. 1 x 25
• Finely stranded with end sleeve (DIN 46228)	mm ²	2 x (0.5 ... 1.5) ¹⁾ , 2 x (0.75 ... 2.5) ¹⁾	2 x (1 ... 2.5) ¹⁾ , 2 x (2.5 ... 6) ¹⁾ , 1 x 10	2 x (1 ... 16) ¹⁾ , 1 x (1 ... 25) ¹⁾	2 x (1 ... 25) ¹⁾ , 1 x (1 ... 35) ¹⁾	1 x (1 ... 16), max. 6 + 16
• AWG cables, solid or stranded	AWG	2 x (20 ... 16) ¹⁾ , 2 x (18 ... 12) ¹⁾	2 x (16 ... 12) ¹⁾ , 2 x (14 ... 8) ¹⁾	2 x (18 ... 3) ¹⁾ , 1 x (18 ... 2) ¹⁾	2 x (18 ... 2) ¹⁾ , 1 x (18 ... 1) ¹⁾	2 x (14 ... 10)
Connection type		 Spring-loaded terminals				
Operating devices	mm	3.0 x 0.5				
Conductor cross-sections (min./max.), one or two conductors can be connected						
• Solid or stranded	mm ²	2 x (0.5 ... 4)	2 x (1 ... 10)	--		
• Finely stranded without end sleeve	mm ²	2 x (0.5 ... 2.5)	2 x (1 ... 6)	--		
• Finely stranded with end sleeve (DIN 46228)	mm ²	2 x (0.5 ... 2.5)	2 x (1 ... 6)	--		
• AWG cables, solid or stranded	AWG	2 x (20 ... 12)	2 x (18 ... 8)	--		
Max. external diameter of the conductor insulation	mm	3.6	6.4	--		

¹⁾ If two different conductor cross-sections are connected to one clamping point, both cross-sections must be in the range specified.



Protection equipment

Motor starter protectors/circuit breakers

SIRIUS 3RV2 motor starter protectors/circuit breakers

General data

Conductor cross-sections of main circuit (continued)

Type		3RV2.4/ 3RV2742	3RV1611-0BD10 ¹⁾ / 3RV1011
Size		S3	S00
Connection type		 Screw terminals with box terminal	 Screw terminals
Terminal screw		M6	Pozidriv size 2
Prescribed tightening torque	Nm	4.5 ... 6	0.8 ... 1.2
Conductor cross-sections (min./max.), one or two conductors can be connected			
• Solid or stranded	mm ²	2 x (2.5 ... 16) ²⁾ , 2 x (10 ... 50) ²⁾ , 1 x (10 ... 70) ²⁾	2 x (0.5 ... 1.5) ²⁾ , 2 x (0.75 ... 2.5) ²⁾
• Finely stranded with end sleeve (DIN 46228)	mm ²	2 x (2.5 ... 35) ²⁾ , 1 x (2.5 ... 50) ²⁾	2 x (0.5 ... 1.5) ²⁾ , 2 x (0.75 ... 2.5) ²⁾
• AWG cables, solid or stranded	AWG	2 x (10 ... 1/0) ²⁾ , 1 x (10 ... 2/0) ²⁾	2 x (18 ... 14)
Ribbon cable conductors (number x width x thickness)	mm	2 x (6 x 9 x 0.8)	--
Removable box terminals³⁾			
• With copper bars ⁴⁾	mm	2 x 12 x 4	--
• With cable lugs ⁵⁾			
- Terminal screw		M6	
- Prescribed tightening torque	Nm	4.5 ... 6	
- Usable ring cable lugs	mm	d ₂ = min. 6.3 d ₃ = max. 19	

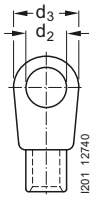

¹⁾ "Technical specifications" for 3RV16 voltage transformer circuit breakers, see page 7/24.



²⁾ If two different conductor cross-sections are connected to one clamping point, both cross-sections must be in the range specified.

³⁾ Cable lug and busbar connection possible after removing the box terminals. This does not apply for 3RV2742.

⁴⁾ If bars larger than 12 mm x 10 mm are connected, a 3RT2946-4EA2 cover is needed to maintain the required phase clearance, see page 7/59.

⁵⁾ If conductors larger than 25 mm² are connected, the 3RT2946-4EA2 cover is needed to maintain the required phase clearance, see page 7/59.

Conductor cross-sections for auxiliary and control circuits¹⁾

Type		3RV2.11	3RV1011/ 3RV1611- 0BD10 ²⁾	3RV2.21	3RV2.3	3RV2.4	3RV27, 3RV28
Size		S00		S0	S2	S3	S00, S0, S3
Connection type		 Screw terminals					
Terminal screw		M3, Pozidriv size 2					
Operating devices	mm	∅ 5 ... 6					
Prescribed tightening torque	Nm	0.8 ... 1.2					
Conductor cross-sections (min./max.), one or two conductors can be connected							
• Solid or stranded	mm ²	2 x (0.5 ... 1.5) ³⁾ , 2 x (0.75 ... 2.5) ³⁾					
• Finely stranded with end sleeve (DIN 46228)	mm ²	2 x (0.5 ... 1.5) ³⁾ , 2 x (0.75 ... 2.5) ³⁾					
• AWG cables, solid or stranded	AWG	2 x (18 ... 14) ³⁾ , 2 x (20 ... 16) ³⁾					
Connection type		 Spring-loaded terminals					
Operating devices	mm	3.0 x 0.5					
Conductor cross-sections (min./max.), one or two conductors can be connected							
• Solid or stranded	mm ²	2 x (0.5 ... 2.5)					
• Finely stranded without end sleeve	mm ²	2 x (0.5 ... 2.5)					
• Finely stranded with end sleeve (DIN 46228)	mm ²	2 x (0.5 ... 1.5)					
• AWG cables, solid or stranded	AWG	2 x (20 ... 14)					
Max. external diameter of the conductor insulation	mm	3.6					

¹⁾ The conductor cross-sections also apply to the 3RV2901-1. auxiliary switch, 3RV2921-1M signaling switch and 3RV29.2-1.... auxiliary release.

²⁾ "Technical specifications" for 3RV16 voltage transformer circuit breakers, see page 7/24.

³⁾ If two different conductor cross-sections are connected to one clamping point, both cross-sections must be in the range specified.

Protection equipment

Motor starter protectors/circuit breakers

SIRIUS 3RV2 motor starter protectors/circuit breakers

General data

Voltage transformer circuit breakers

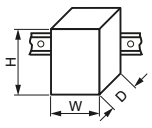
General data						
Type			3RV1611-1AG14	3RV1611-1CG14	3RV1611-1DG14	
Size			S00	S00	S00	
Dimensions (W x H x D)			mm	45 x 90 x 70	45 x 90 x 70	45 x 90 x 70
Rated current I_n		A	1.4	2.5	3	
Ambient temperature		°C	-50 ... +80			
• During storage/transport		°C	-20 ... +60 (up to +70 °C possible with current reduction)			
• During operation		°C	-20 ... +60 (up to +70 °C possible with current reduction)			
Rated operational voltage U_e		V	400			
Rated frequency		Hz	16.66 ... 60			
Rated insulation voltage U_i		V	690			
Short-circuit breaking capacity I_{cu} at 400 V AC		kA	50			
Set value of the thermal overload release		A	1.4	2.5	3	
Response value of the instantaneous electronic release		A	6 ±20%	10.5 ±20%	20 ±20%	
Tripping time of the instantaneous electronic release		ms	Approx. 6 at 12 A	Approx. 6 at 20 A	Approx. 6 at 40 A	
Internal resistance		Ω				
• In cold state		Ω	> 0.25 ±6.5%			
• In heated state		Ω	> 0.30 ±6.5%			
Shock resistance according to IEC 60068-2-27		g/ms	15			
Degree of protection IP on the front according to IEC 60529			IP20			
Touch protection on the front according to IEC 60529			Finger-safe for vertical touching from the front			
Endurance						
• Mechanical	Operating cycles		10 000			
• Electrical	Operating cycles		10 000			
Permissible mounting position			Any			

Type			3RV1611-1AG14	3RV1611-1CG14	3RV1611-1DG14
Conductor cross-sections, main circuit, 1 or 2 conductors					
Connection type			 Screw terminals		
Terminal screw			Pozidriv size 2		
Conductor cross-sections (min./max.), one or two conductors can be connected					
• Solid or stranded	mm ²		2 x (0.5 ... 1.5) ¹⁾ , 2 x (0.75 ... 2.5) ¹⁾ , 2 x (1 ... 4)		
• Finely stranded with end sleeve (DIN 46228)	mm ²		2 x (0.5 ... 1.5) ¹⁾ , 2 x (0.75 ... 2.5) ¹⁾		
Auxiliary switches for blocking the distance protection					
With defined lateral assignment for blocking distance protection			1 CO (for use as 1 NO or 1 NC)		
Rated operational voltage U_e	Alternating voltage	V	125		
Rated operational current $I_e/AC-14$	at $U_e = 125$ V	A	0.1		
Rated operational voltage U_e	Direct voltage L/R 200 ms	V	60		
Rated operational current $I_e/DC-13$	at $U_e = 60$ V	A	0.3		
Minimum load capacity		V	5		
		mA	1		
Short-circuit protection for auxiliary circuit					
Melting fuse		A	250 V type FF 2A (prospective short-circuit current < 1.1 kA)		

¹⁾ If two different conductor cross-sections are connected to one clamping point, both cross-sections must be in the range specified.



Protection equipment

Motor starter protectors/circuit breakers

SIRIUS 3RV2 motor starter protectors/circuit breakers

General data

Terminals for "Self-Protected Combination Motor Controllers (Type E) according to UL 508/UL 60947-4-1"

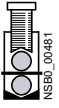
Type	3RV2928-1H	
Prescribed tightening torque	Nm	2.5 ... 3
Conductor cross-sections		
<ul style="list-style-type: none"> • Front clamping point connected 		
<ul style="list-style-type: none"> - Solid - Finely stranded with end sleeve - Stranded - AWG cables, solid or stranded - Terminal screw 	mm ² mm ² mm ² AWG	1 ... 10 1 ... 16 2.5 ... 25 14 ... 3 M4
<ul style="list-style-type: none"> • Rear clamping point connected 		
<ul style="list-style-type: none"> - Solid - Finely stranded with end sleeve - Stranded - AWG cables, solid or stranded - Terminal screw 	mm ² mm ² mm ² AWG	1 ... 10 1 ... 16 1.5 ... 25 14 ... 6 M4
<ul style="list-style-type: none"> • Both clamping points connected 		
<ul style="list-style-type: none"> - Front clamping point: Solid Finely stranded with end sleeve Stranded AWG cables, solid or stranded Terminal screw - Rear clamping point: Solid Finely stranded with end sleeve Stranded AWG cables, solid or stranded Terminal screw 	mm ² mm ² mm ² AWG mm ² mm ² mm ² AWG	1 ... 10 1 ... 10 ¹⁾ , 1 ... 6 ¹⁾ 2.5 ... 10 14 ... 6 M4 1 ... 10 1 ... 10 ¹⁾ , 1 ... 16 ¹⁾ 2.5 ... 10 16 ... 3 M4

¹⁾ The following connections are possible when both clamping points are connected:

- front 1 to 10 mm² and rear 1 to 10 mm²,
- front 1 to 6 mm² and rear 1 to 16 mm².

Protection equipment

Motor starter protectors/circuit breakers

SIRIUS 3RV2 motor starter protectors/circuit breakers

General data

Connection module (plug and adapter) for motor starter protectors/circuit breakers with screw terminals			
Type		3RT1900-4RE01 Motor feeder connector S0	3RT1926-4RD01 Adapter S0
General data			
Rated insulation voltage U_i (pollution degree 3)	V	690	
Rated impulse withstand voltage U_{imp} (pollution degree 3)	kV	6	
Rated operational voltage U_e	V	440	
Rated frequency f For AC operation	Hz	50/60	
Rated operational current I_e AC-3 and AC-3e at 400 V	A	25	
Mechanical endurance	Operating cycles	10 million	
Electrical endurance at I_e	Operating cycles	1 million	
Protective separation according to IEC 60947-1 (pollution degree 3)	V	400	
Permissible ambient temperature			
• During operation	°C	-25 ... +60	
• During storage	°C	-50 ... +80	
Conductor cross-sections			
Connection type		 Screw terminals	
• Solid	mm ²	1 x (0.5 ... 6)	
• Finely stranded without/with end sleeve	mm ²	1 x (0.5 ... 6)	
• Stranded	mm ²	1 x (0.5 ... 6)	
• AWG cables, solid or stranded	AWG	1 x (20 ... 10)	
• Tightening torque	Nm	0.6 ... 0.8	
• Corresponding opening tool		Cross-tip screwdriver PZ2	
Ⓢ and Ⓞ rated data			
Rated operational voltage U_e	V	480	
Rated insulation voltage U_i	V	600	
Uninterrupted current, at 40 °C	A	25	
Short-circuit protection ¹⁾			
• At 600 V	kA	5	
• CLASS RK5 fuse	A	100	
• Circuit breakers with overload protection according to UL 489	A	100	
Combination motor controllers type E according to UL 508			
	at 480 V Type	3RV202	
	A	22	
	kA	65	
	at 600 V Type	3RV202	
	A	22	
	kA	10	

¹⁾ For more information about short-circuit values, e.g. for protection against high short-circuit currents, see the [UL reports](#).

Protection equipment

Motor starter protectors/circuit breakers

SIRIUS 3RV2 motor starter protectors/circuit breakers

AC-3e

IE3/IE4 ready

For motor protection

Selection and ordering data

CLASS 10, without auxiliary switches

PU (UNIT, SET, M) = 1
 PS* = 1 unit
 PG = 41E

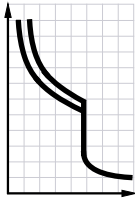

3RV2011-...A10,
3RV2011-...A10-0BA0



3RV2011-...A20,
3RV2011-...AA20-0BA0

Rated current I_n A	Suitable for three-phase motors ¹⁾ with P kW	Setting range for thermal overload release A	Instantaneous electronic release A	Short-circuit breaking capacity at 400 V AC I_{cu} kA	Screw terminals		Spring-loaded terminals	
					Article No.	Price per PU	Article No.	Price per PU
Size S00								
0.16	0.04	0.11 ... 0.16	2.1	100	3RV2011-0AA10		3RV2011-0AA20	
0.2	0.06	0.14 ... 0.2	2.6	100	3RV2011-0BA10		3RV2011-0BA20	
0.25	0.06	0.18 ... 0.25	3.3	100	3RV2011-0CA10		3RV2011-0CA20	
0.32	0.09	0.22 ... 0.32	4.2	100	3RV2011-0DA10		3RV2011-0DA20	
0.4	0.09	0.28 ... 0.4	5.2	100	3RV2011-0EA10		3RV2011-0EA20	
0.5	0.12	0.35 ... 0.5	6.5	100	3RV2011-0FA10		3RV2011-0FA20	
0.63	0.18	0.45 ... 0.63	8.2	100	3RV2011-0GA10		3RV2011-0GA20	
0.8	0.18	0.55 ... 0.8	10	100	3RV2011-0HA10		3RV2011-0HA20	
1	0.25	0.7 ... 1	13	100	3RV2011-0JA10		3RV2011-0JA20	
1.25	0.37	0.9 ... 1.25	16	100	3RV2011-0KA10		3RV2011-0KA20	
1.6	0.55	1.1 ... 1.6	21	100	3RV2011-1AA10		3RV2011-1AA20	
2	0.75	1.4 ... 2	26	100	3RV2011-1BA10		3RV2011-1BA20	
2.5	0.75	1.8 ... 2.5	33	100	3RV2011-1CA10		3RV2011-1CA20	
3.2	1.1	2.2 ... 3.2	42	100	3RV2011-1DA10		3RV2011-1DA20	
4	1.5	2.8 ... 4	52	100	3RV2011-1EA10		3RV2011-1EA20	
5	1.5	3.5 ... 5	65	100	3RV2011-1FA10		3RV2011-1FA20	
6.3	2.2	4.5 ... 6.3	82	100	3RV2011-1GA10		3RV2011-1GA20	
8	3	5.5 ... 8	104	100	3RV2011-1HA10		3RV2011-1HA20	
10	4	7 ... 10	130	100	3RV2011-1JA10		3RV2011-1JA20	
12.5	5.5	9 ... 12.5	163	100	3RV2011-1KA10		3RV2011-1KA20	
16	7.5	10 ... 16	208	55	3RV2011-4AA10		3RV2011-4AA20	
For special operating conditions down to -50 °C²⁾³⁾								
1.25	0.37	0.9 ... 1.25	16	100	3RV2011-0KA10-0BA0		--	
1.6	0.55	1.1 ... 1.6	21	100	3RV2011-1AA10-0BA0		3RV2011-1AA20-0BA0	
2.5	0.75	1.8 ... 2.5	33	100	3RV2011-1CA10-0BA0		--	
3.2	1.1	2.2 ... 3.2	42	100	3RV2011-1DA10-0BA0		--	
4	1.5	2.8 ... 4	52	100	3RV2011-1EA10-0BA0		--	
5	1.5	3.5 ... 5	65	100	3RV2011-1FA10-0BA0		--	
6.3	2.2	4.5 ... 6.3	82	100	3RV2011-1GA10-0BA0		--	
8	3	5.5 ... 8	104	100	3RV2011-1HA10-0BA0		--	
10	4	7 ... 10	130	100	3RV2011-1JA10-0BA0		--	
12.5	5.5	9 ... 12.5	163	100	3RV2011-1KA10-0BA0		--	
16	7.5	10 ... 16	208	55	3RV2011-4AA10-0BA0		3RV2011-4AA20-0BA0	

¹⁾ Guide value for 4-pole standard motors at 50 Hz 400 V AC. The actual starting and rated data of the motor to be protected must be considered when selecting the units.

²⁾ The 3RV2011-...-0BA0 motor starter protectors have a mechanical endurance of 500 operating cycles.

³⁾ The motor starter protectors do not have UL/CSA approval and are not certified either according to the European Explosion Protection Directive (ATEX) or according to the International Explosion Protection Standard (IECEx).

Auxiliary switches and other accessories can be ordered separately (see page 7/48 onwards).

Protection equipment

Motor starter protectors/circuit breakers

SIRIUS 3RV2 motor starter protectors/circuit breakers

For motor protection **IE3/IE4 ready** **AC-3e**

CLASS 10, without auxiliary switches

PU (UNIT, SET, M) = 1
 PS* = 1 unit
 PG = 41E

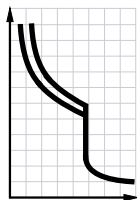

3RV221-...A10, 3RV221-4.A10-0BA0



3RV221-..A20, 3RV221-..A20-0BA0

Rated current	Suitable for three-phase motors ¹⁾ with ▶	Setting range for thermal overload release	Instantaneous electronic release	Short-circuit breaking capacity at 400 V AC	Screw terminals	Spring-loaded terminals
I_n				I_{cu}	Article No.	Price per PU
A	kW	A	A	kA	Article No.	Price per PU
Size S0						
0.16	0.04	0.11 ... 0.16	2.1	100	3RV221-0AA10	--
0.2	0.06	0.14 ... 0.2	2.6	100	3RV221-0BA10	--
0.25	0.06	0.18 ... 0.25	3.3	100	3RV221-0CA10	--
0.32	0.09	0.22 ... 0.32	4.2	100	3RV221-0DA10	--
0.4	0.09	0.28 ... 0.4	5.2	100	3RV221-0EA10	--
0.5	0.12	0.35 ... 0.5	6.5	100	3RV221-0FA10	--
0.63	0.18	0.45 ... 0.63	8.2	100	3RV221-0GA10	3RV221-0GA20
0.8	0.18	0.55 ... 0.8	10	100	3RV221-0HA10	3RV221-0HA20
1	0.25	0.7 ... 1	13	100	3RV221-0JA10	3RV221-0JA20
1.25	0.37	0.9 ... 1.25	16	100	3RV221-0KA10	3RV221-0KA20
1.6	0.55	1.1 ... 1.6	21	100	3RV221-1AA10	3RV221-1AA20
2	0.75	1.4 ... 2	26	100	3RV221-1BA10	3RV221-1BA20
2.5	0.75	1.8 ... 2.5	33	100	3RV221-1CA10	3RV221-1CA20
3.2	1.1	2.2 ... 3.2	42	100	3RV221-1DA10	3RV221-1DA20
4	1.5	2.8 ... 4	52	100	3RV221-1EA10	3RV221-1EA20
5	1.5	3.5 ... 5	65	100	3RV221-1FA10	3RV221-1FA20
6.3	2.2	4.5 ... 6.3	82	100	3RV221-1GA10	3RV221-1GA20
8	3	5.5 ... 8	104	100	3RV221-1HA10	3RV221-1HA20
10	4	7 ... 10	130	100	3RV221-1JA10	3RV221-1JA20
12.5	5.5	9 ... 12.5	163	100	3RV221-1KA10	3RV221-1KA20
16	7.5	10 ... 16	208	55	3RV221-4AA10	3RV221-4AA20
20	7.5	13 ... 20	260	55	3RV221-4BA10	3RV221-4BA20
22	11	16 ... 22	286	55	3RV221-4CA10	3RV221-4CA20
25	11	18 ... 25	325	55	3RV221-4DA10	3RV221-4DA20
28	15	23 ... 28	364	55	3RV221-4NA10	3RV221-4NA20
32 ²⁾	15	27 ... 32	400	55	3RV221-4EA10	3RV221-4EA20
36 ³⁾	18.5	30 ... 36	432	20	3RV221-4PA10	--
40 ³⁾	18.5	34 ... 40	480	20	3RV221-4FA10	--

For special operating conditions down to -50 °C⁴⁾⁵⁾

1	0.25	0.7 ... 1	13	100	--	3RV221-0JA20-0BA0
1.6	0.55	1.1 ... 1.6	21	100	--	3RV221-1AA20-0BA0
2	0.75	1.4 ... 2	26	100	--	3RV221-1BA20-0BA0
2.5	0.75	1.8 ... 2.5	33	100	--	3RV221-1CA20-0BA0
4	1.5	2.8 ... 4	52	100	--	3RV221-1EA20-0BA0
6.3	2.2	4.5 ... 6.3	82	100	--	3RV221-1GA20-0BA0
8	3	5.5 ... 8	104	100	--	3RV221-1HA20-0BA0
10	4	7 ... 10	130	100	--	3RV221-1JA20-0BA0
12.5	5.5	9 ... 12.5	163	100	--	3RV221-1KA20-0BA0
16	7.5	10 ... 16	208	55	--	3RV221-4AA20-0BA0
20	7.5	13 ... 20	260	55	3RV221-4BA10-0BA0	--
22	11	16 ... 22	286	55	3RV221-4CA10-0BA0	--
25	11	18 ... 25	325	55	3RV221-4DA10-0BA0	3RV221-4DA20-0BA0
28	15	23 ... 28	364	55	--	3RV221-4NA20-0BA0
32 ²⁾	15	27 ... 32	400	55	3RV221-4EA10-0BA0	3RV221-4EA20-0BA0
36 ³⁾	18.5	30 ... 36	432	20	--	3RV221-4EA20-0BA0
40 ³⁾	18.5	34 ... 40	480	20	3RV221-4FA10-0BA0	--

¹⁾ Guide value for 4-pole standard motors at 50 Hz 400 V AC. The actual starting and rated data of the motor to be protected must be considered when selecting the units.

²⁾ Suitable for use with IE3 and IE4 motors up to a starting current of 256 A. For higher starting currents we recommend using 3RV2 motor starter protectors size S2.

³⁾ The devices must not be mounted side-by-side and they must not be assembled with link modules with contactors. A lateral clearance of 9 mm is required. For use with IE3 and IE4 motors we recommend using 3RV2 motor starter protectors size S2.

⁴⁾ The 3RV221-...-0BA0 motor starter protectors have a mechanical endurance of 500 operating cycles.

⁵⁾ The motor starter protectors do not have UL/CSA approval and are not certified either according to the European Explosion Protection Directive (ATEX) or according to the International Explosion Protection Standard (IECEx).

Auxiliary switches and other accessories can be ordered separately (see page 7/48 onwards).

Protection equipment

Motor starter protectors/circuit breakers

SIRIUS 3RV2 motor starter protectors/circuit breakers



AC-3e

IE3/IE4 ready

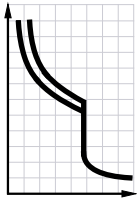
For motor protection

CLASS 10, without auxiliary switches3RV2031-4.A10,
3RV2031-4.A10-0BA0

3RV2032-4.A10

Rated current	Suitable for three-phase motors ¹⁾ with P	Setting range for thermal overload release	Instantaneous electronic release	Short-circuit breaking capacity at 400 V AC	Screw terminals 	PU (UNIT, SET, M)	PS*	PG
I_n				I_{cu}	Article No.	Price per PU		
A	kW	A	A	kA				
Size S2								
14	5.5	9.5 ... 14	208	65	3RV2031-4SA10	1	1 unit	41E
17	7.5	12 ... 17	260	65	3RV2031-4TA10	1	1 unit	41E
20	7.5	14 ... 20	260	65	3RV2031-4BA10	1	1 unit	41E
25	11	18 ... 25	325	65	3RV2031-4DA10	1	1 unit	41E
32	15	22 ... 32	416	65	3RV2031-4EA10	1	1 unit	41E
36	18.5	28 ... 36	520	65	3RV2031-4PA10	1	1 unit	41E
40	18.5	32 ... 40	585	65	3RV2031-4UA10	1	1 unit	41E
45	22	35 ... 45	650	65	3RV2031-4VA10	1	1 unit	41E
52	22	42 ... 52	741	65	3RV2031-4WA10	1	1 unit	41E
59	30	49 ... 59	845	65	3RV2031-4XA10	1	1 unit	41E
65	30	54 ... 65	845	65	3RV2031-4JA10	1	1 unit	41E
73	37	62 ... 73	949	65	3RV2031-4KA10	1	1 unit	41E
80 ²⁾	37	70 ... 80	1 040	65	3RV2031-4RA10	1	1 unit	41E
For special operating conditions down to -50 °C³⁾⁴⁾								
25	11	18 ... 25	325	65	3RV2031-4DA10-0BA0	1	1 unit	41E
32	15	22 ... 32	416	65	3RV2031-4EA10-0BA0	1	1 unit	41E
65	30	54 ... 65	845	65	3RV2031-4JA10-0BA0	1	1 unit	41E
Size S2, with increased switching capacity								
14	5.5	9.5 ... 14	208	100	3RV2032-4SA10	1	1 unit	41E
17	7.5	12 ... 17	260	100	3RV2032-4TA10	1	1 unit	41E
20	7.5	14 ... 20	260	100	3RV2032-4BA10	1	1 unit	41E
25	11	18 ... 25	325	100	3RV2032-4DA10	1	1 unit	41E
32	15	22 ... 32	416	100	3RV2032-4EA10	1	1 unit	41E
36	18.5	28 ... 36	520	100	3RV2032-4PA10	1	1 unit	41E
40	18.5	32 ... 40	585	100	3RV2032-4UA10	1	1 unit	41E
45	22	35 ... 45	650	100	3RV2032-4VA10	1	1 unit	41E
52	22	42 ... 52	741	100	3RV2032-4WA10	1	1 unit	41E
59	30	49 ... 59	845	100	3RV2032-4XA10	1	1 unit	41E
65	30	54 ... 65	845	100	3RV2032-4JA10	1	1 unit	41E
73	37	62 ... 73	949	100	3RV2032-4KA10	1	1 unit	41E
80 ²⁾	37	70 ... 80	1 040	100	3RV2032-4RA10	1	1 unit	41E

¹⁾ Guide value for 4-pole standard motors at 50 Hz 400 V AC. The actual starting and rated data of the motor to be protected must be considered when selecting the units.

²⁾ Suitable for use with IE3 and IE4 motors up to a starting current of 720 A. For higher starting currents we recommend using 3RV2 motor starter protectors size S3.

³⁾ The 3RV2031-.....-0BA0 motor starter protectors have a mechanical endurance of 250 operating cycles.

⁴⁾ The motor starter protectors do not have UL/CSA approval and are not certified either according to the European Explosion Protection Directive (ATEX) or according to the International Explosion Protection Standard (IECEx).

Auxiliary switches and other accessories can be ordered separately (see page 7/48 onwards).

Protection equipment

Motor starter protectors/circuit breakers



SIRIUS 3RV2 motor starter protectors/circuit breakers

For motor protection **IE3/IE4 ready** **AC-3e**

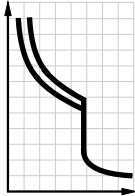
CLASS 10, without auxiliary switches



3RV204.-4.A10

Rated current	Suitable for three-phase motors ¹⁾ with P	Setting range for thermal overload release	Instantaneous electronic release	Short-circuit breaking capacity at 400 V AC	Screw terminals 	PU (UNIT, SET, M)	PS*	PG
I_n				I_{cu}	Article No.	Price per PU		
A	kW	A	A	kA				
Size S3								
40	18.5	28 ... 40	520	65	3RV2041-4FA10	1	1 unit	41E
50	22	36 ... 50	650	65	3RV2041-4HA10	1	1 unit	41E
63	30	45 ... 63	819	65	3RV2041-4JA10	1	1 unit	41E
75	37	57 ... 75	975	65	3RV2041-4KA10	1	1 unit	41E
84	45	65 ... 84	1 170	65	3RV2041-4RA10	1	1 unit	41E
93	45	75 ... 93	1 300	65	3RV2041-4YA10	1	1 unit	41E
100 ²⁾	45, 55	80 ... 100	1 300	65	3RV2041-4MA10	1	1 unit	41E
Size S3, with increased switching capacity								
40	18.5	28 ... 40	520	100	3RV2042-4FA10	1	1 unit	41E
50	22	36 ... 50	650	100	3RV2042-4HA10	1	1 unit	41E
63	30	45 ... 63	819	100	3RV2042-4JA10	1	1 unit	41E
75	37	57 ... 75	975	100	3RV2042-4KA10	1	1 unit	41E
84	45	65 ... 84	1 170	100	3RV2042-4RA10	1	1 unit	41E
93	45	75 ... 93	1 300	100	3RV2042-4YA10	1	1 unit	41E
100 ²⁾	45, 55	80 ... 100	1 300	100	3RV2042-4MA10	1	1 unit	41E

¹⁾ Guide value for 4-pole standard motors at 50 Hz 400 V AC. The actual starting and rated data of the motor to be protected must be considered when selecting the units.

²⁾ Suitable for use with IE3 and IE4 motors up to a starting current of 780 A. For higher starting currents we recommend using 3VA circuit breakers (see Catalog LV 10).

Auxiliary switches and other accessories can be ordered separately (see page 7/48 onwards).

Protection equipment

Motor starter protectors/circuit breakers

SIRIUS 3RV2 motor starter protectors/circuit breakers

AC-3e

IE3/IE4 ready

For motor protection

CLASS 10, with transverse auxiliary switch (1 NO + 1 NC)

PU (UNIT, SET, M) = 1
 PS* = 1 unit
 PG = 41E

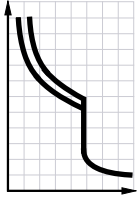

3RV2011-...A15

3RV2011-...A25,
3RV2011-1EA25-0BA03RV2.21-4.A15,
3RV2021-4.A15-0BA0

3RV2021-4.A25

Rated current	Suitable for three-phase motors ¹⁾ with P	Setting range for thermal overload release	Instantaneous electronic release	Short-circuit breaking capacity at 400 V AC	Screw terminals	Spring-loaded terminals
I_n				I_{cu}	Article No.	Price per PU
A	kW	A	A	kA		Article No.
Size S00						
0.16	0.04	0.11 ... 0.16	2.1	100	3RV2011-0AA15	3RV2011-0AA25
0.2	0.06	0.14 ... 0.2	2.6	100	3RV2011-0BA15	3RV2011-0BA25
0.25	0.06	0.18 ... 0.25	3.3	100	3RV2011-0CA15	3RV2011-0CA25
0.32	0.09	0.22 ... 0.32	4.2	100	3RV2011-0DA15	3RV2011-0DA25
0.4	0.09	0.28 ... 0.4	5.2	100	3RV2011-0EA15	3RV2011-0EA25
0.5	0.12	0.35 ... 0.5	6.5	100	3RV2011-0FA15	3RV2011-0FA25
0.63	0.18	0.45 ... 0.63	8.2	100	3RV2011-0GA15	3RV2011-0GA25
0.8	0.18	0.55 ... 0.8	10	100	3RV2011-0HA15	3RV2011-0HA25
1	0.25	0.7 ... 1	13	100	3RV2011-0JA15	3RV2011-0JA25
1.25	0.37	0.9 ... 1.25	16	100	3RV2011-0KA15	3RV2011-0KA25
1.6	0.55	1.1 ... 1.6	21	100	3RV2011-1AA15	3RV2011-1AA25
2	0.75	1.4 ... 2	26	100	3RV2011-1BA15	3RV2011-1BA25
2.5	0.75	1.8 ... 2.5	33	100	3RV2011-1CA15	3RV2011-1CA25
3.2	1.1	2.2 ... 3.2	42	100	3RV2011-1DA15	3RV2011-1DA25
4	1.5	2.8 ... 4	52	100	3RV2011-1EA15	3RV2011-1EA25
5	1.5	3.5 ... 5	65	100	3RV2011-1FA15	3RV2011-1FA25
6.3	2.2	4.5 ... 6.3	82	100	3RV2011-1GA15	3RV2011-1GA25
8	3	5.5 ... 8	104	100	3RV2011-1HA15	3RV2011-1HA25
10	4	7 ... 10	130	100	3RV2011-1JA15	3RV2011-1JA25
12.5	5.5	9 ... 12.5	163	100	3RV2011-1KA15	3RV2011-1KA25
16	7.5	10 ... 16	208	55	3RV2011-4AA15	3RV2011-4AA25
For special operating conditions down to -50 °C²⁾³⁾						
2	0.06	1.4 ... 2	2.6	100	3RV2011-1BA15-0BA0	--
2.5	0.75	1.8 ... 2.5	33	100	3RV2011-1CA15-0BA0	--
4	1.5	2.8 ... 4	52	100	3RV2011-1EA15-0BA0	3RV2011-1EA25-0BA0
5	1.5	3.5 ... 5	65	100	3RV2011-1FA15-0BA0	--
6.3	2.2	4.5 ... 6.3	82	100	3RV2011-1GA15-0BA0	--
8	3	5.5 ... 8	104	100	3RV2011-1HA15-0BA0	--
12.5	5.5	9 ... 12.5	163	100	3RV2011-1KA15-0BA0	--
16	7.5	10 ... 16	208	55	3RV2011-4AA15-0BA0	--
Size S0						
16	7.5	10 ... 16	208	55	3RV2021-4AA15	3RV2021-4AA25
20	7.5	13 ... 20	260	55	3RV2021-4BA15	3RV2021-4BA25
22	11	16 ... 22	286	55	3RV2021-4CA15	3RV2021-4CA25
25	11	18 ... 25	325	55	3RV2021-4DA15	3RV2021-4DA25
28	15	23 ... 28	364	55	3RV2021-4NA15	3RV2021-4NA25
32 ⁴⁾	15	27 ... 32	400	55	3RV2021-4EA15	3RV2021-4EA25
36 ⁵⁾	18.5	30 ... 36	432	20	3RV2021-4PA15	--
40 ⁵⁾	18.5	34 ... 40	480	20	3RV2021-4FA15	--
For special operating conditions down to -50 °C²⁾³⁾						
20	7.5	13 ... 20	260	55	3RV2021-4BA15-0BA0	--
32 ⁴⁾	15	27 ... 32	400	55	3RV2021-4EA15-0BA0	--

- 1) Guide value for 4-pole standard motors at 50 Hz 400 V AC. The actual starting and rated data of the motor to be protected must be considered when selecting the units.
- 2) The 3RV20.1-...-0BA0 motor starter protectors in sizes S00 and S0 have a mechanical endurance of 500 operating cycles.
- 3) The motor starter protectors do not have UL/CSA approval and are not certified either according to the European Explosion Protection Directive (ATEX) or according to the International Explosion Protection Standard (IECEx).
- 4) Suitable for use with IE3 and IE4 motors up to a starting current of 256 A. For higher starting currents we recommend using 3RV2 motor starter protectors size S2.

- 5) The devices must not be mounted side-by-side and they must not be assembled with link modules with contactors. A lateral clearance of 9 mm is required. For use with IE3 and IE4 motors we recommend using 3RV2 motor starter protectors size S2.

Auxiliary switches and other accessories can be ordered separately (see page 7/48 onwards).

Protection equipment

Motor starter protectors/circuit breakers

SIRIUS 3RV2 motor starter protectors/circuit breakers

For motor protection **IE3/IE4 ready** **AC-3e**

CLASS 10, with transverse auxiliary switch (1 NO + 1 NC)

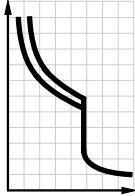

3RV2031-4..15,
3RV2031-4.A15-0BA0



3RV2032-4.A15



3RV2041-4.A15

Rated current	Suitable for three-phase motors ¹⁾ with P	Setting range for thermal overload release	Instantaneous electronic release	Short-circuit breaking capacity at 400 V AC	Screw terminals	PU (UNIT, SET, M)	PS*	PG
I_n				I_{cu}	Article No.	Price per PU		
A	kW	A	A	kA				
Size S2								
14	5.5	9.5 ... 14	208	65	3RV2031-4SA15	1	1 unit	41E
17	7.5	12 ... 17	260	65	3RV2031-4TA15	1	1 unit	41E
20	7.5	14 ... 20	260	65	3RV2031-4BA15	1	1 unit	41E
25	11	18 ... 25	325	65	3RV2031-4DA15	1	1 unit	41E
32	15	22 ... 32	416	65	3RV2031-4EA15	1	1 unit	41E
36	18.5	28 ... 36	520	65	3RV2031-4PA15	1	1 unit	41E
40	18.5	32 ... 40	585	65	3RV2031-4UA15	1	1 unit	41E
45	22	35 ... 45	650	65	3RV2031-4VA15	1	1 unit	41E
52	22	42 ... 52	741	65	3RV2031-4WA15	1	1 unit	41E
59	30	49 ... 59	845	65	3RV2031-4XA15	1	1 unit	41E
65	30	54 ... 65	845	65	3RV2031-4JA15	1	1 unit	41E
73	37	62 ... 73	949	65	3RV2031-4KA15	1	1 unit	41E
80 ²⁾	37	70 ... 80	1 040	65	3RV2031-4RA15	1	1 unit	41E
For special operating conditions down to -50 °C³⁾⁴⁾								
14	5.5	9.5 ... 14	208	65	3RV2031-4SA15-0BA0	1	1 unit	41E
20	7.5	14 ... 20	260	65	3RV2031-4BA15-0BA0	1	1 unit	41E
32	15	22 ... 32	416	65	3RV2031-4EA15-0BA0	1	1 unit	41E
45	22	35 ... 45	650	65	3RV2031-4VA15-0BA0	1	1 unit	41E
Size S2, with increased switching capacity								
14	5.5	9.5 ... 14	208	10	3RV2032-4SA15	1	1 unit	41E
17	7.5	12 ... 17	260	100	3RV2032-4TA15	1	1 unit	41E
20	7.5	14 ... 20	260	100	3RV2032-4BA15	1	1 unit	41E
25	11	18 ... 25	325	100	3RV2032-4DA15	1	1 unit	41E
32	15	22 ... 32	416	100	3RV2032-4EA15	1	1 unit	41E
36	18.5	28 ... 36	520	100	3RV2032-4PA15	1	1 unit	41E
40	18.5	32 ... 40	585	100	3RV2032-4UA15	1	1 unit	41E
45	22	35 ... 45	650	100	3RV2032-4VA15	1	1 unit	41E
52	22	42 ... 52	741	100	3RV2032-4WA15	1	1 unit	41E
59	30	49 ... 59	845	100	3RV2032-4XA15	1	1 unit	41E
65	30	54 ... 65	845	100	3RV2032-4JA15	1	1 unit	41E
73	37	62 ... 73	949	100	3RV2032-4KA15	1	1 unit	41E
80 ²⁾	37	70 ... 80	1 040	100	3RV2032-4RA15	1	1 unit	41E
Size S3								
40	18.5	28 ... 40	520	65	3RV2041-4FA15	1	1 unit	41E
50	22	36 ... 50	650	65	3RV2041-4HA15	1	1 unit	41E
63	30	45 ... 63	819	65	3RV2041-4JA15	1	1 unit	41E
75	37	57 ... 75	975	65	3RV2041-4KA15	1	1 unit	41E
84	45	65 ... 84	1 170	65	3RV2041-4RA15	1	1 unit	41E
93	45	75 ... 93	1 300	65	3RV2041-4YA15	1	1 unit	41E
100 ⁵⁾	45, 55	80 ... 100	1 300	65	3RV2041-4MA15	1	1 unit	41E

¹⁾ Guide value for 4-pole standard motors at 50 Hz 400 V AC. The actual starting and rated data of the motor to be protected must be considered when selecting the units.

²⁾ Suitable for use with IE3 and IE4 motors up to a starting current of 720 A. For higher starting currents we recommend using 3RV2 motor starter protectors size S3.

³⁾ The 3RV2031-.....-0BA0 motor starter protectors have a mechanical endurance of 250 operating cycles.

⁴⁾ The motor starter protectors do not have UL/CSA approval and are not certified either according to the European Explosion Protection Directive (ATEX) or according to the International Explosion Protection Standard (IECEX).

⁵⁾ Suitable for use with IE3 and IE4 motors up to a starting current of 780 A. For higher starting currents we recommend using 3VA circuit breakers (see Catalog LV 10).

Auxiliary switches and other accessories can be ordered separately (see page 7/48 onwards).

Protection equipment

Motor starter protectors/circuit breakers

SIRIUS 3RV2 motor starter protectors/circuit breakers

AC-3e

IE3/IE4 ready

For motor protection

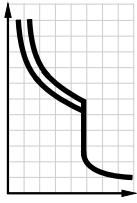
CLASS 20, without auxiliary switches



3RV2031-4.B10,
14 to 45 A;
3RV2031-4.B10-0BA0;
32 to 40 A



3RV2031-4.B10,
52 to 65 A



3RV2042-4.B10,
40 to 100 A

Rated current	Suitable for three-phase motors ¹⁾ with P	Setting range for thermal overload release	Instantaneous release electronic release	Short-circuit breaking capacity at 400 V AC	Screw terminals 	PU (UNIT, SET, M)	PS*	PG
I_n				I_{cu}	Article No.	Price per PU		
A	kW	A	A	kA				
Size S2								
14	5.5	9.5 ... 14	208	65	3RV2031-4SB10	1	1 unit	41E
17	7.5	12 ... 17	260	65	3RV2031-4TB10	1	1 unit	41E
20	7.5	14 ... 20	260	65	3RV2031-4BB10	1	1 unit	41E
25	11	18 ... 25	325	65	3RV2031-4DB10	1	1 unit	41E
32	15	22 ... 32	416	65	3RV2031-4EB10	1	1 unit	41E
36	18.5	28 ... 36	520	65	3RV2031-4PB10	1	1 unit	41E
40	18.5	32 ... 40	585	65	3RV2031-4UB10	1	1 unit	41E
45	22	35 ... 45	650	65	3RV2031-4VB10	1	1 unit	41E
52	22	42 ... 52	741	65	3RV2031-4WB10	1	1 unit	41E
59	30	49 ... 59	845	65	3RV2031-4XB10	1	1 unit	41E
65	30	54 ... 65	845	65	3RV2031-4JB10	1	1 unit	41E
For special operating conditions down to -50 °C²⁾³⁾								
32	15	22 ... 32	416	65	3RV2031-4EB10-0BA0	1	1 unit	41E
36	18.5	28 ... 36	520	65	3RV2031-4PB10-0BA0	1	1 unit	41E
40	18.5	32 ... 40	585	65	3RV2031-4UB10-0BA0	1	1 unit	41E
Size S3, with increased switching capacity								
40	18.5	28 ... 40	520	100	3RV2042-4FB10	1	1 unit	41E
50	22	36 ... 50	650	100	3RV2042-4HB10	1	1 unit	41E
63	30	45 ... 63	819	100	3RV2042-4JB10	1	1 unit	41E
75	37	57 ... 75	975	100	3RV2042-4KB10	1	1 unit	41E
84	45	65 ... 84	1 170	100	3RV2042-4RB10	1	1 unit	41E
93	45	75 ... 93	1 300	100	3RV2042-4YB10	1	1 unit	41E
100 ⁴⁾	45, 55	80 ... 100	1 300	100	3RV2042-4MB10	1	1 unit	41E

¹⁾ Guide value for 4-pole standard motors at 50 Hz 400 V AC. The actual starting and rated data of the motor to be protected must be considered when selecting the units.

²⁾ The 3RV2031-.....-0BA0 motor starter protectors have a mechanical endurance of 250 operating cycles.

³⁾ The motor starter protectors do not have UL/CSA approval and are not certified either according to the European Explosion Protection Directive (ATEX) or according to the International Explosion Protection Standard (IECEX).

⁴⁾ Suitable for use with IE3 and IE4 motors up to a starting current of 780 A. For higher starting currents we recommend using 3VA circuit breakers (see Catalog LV 10).

Auxiliary switches and other accessories can be ordered separately (see page 7/48 onwards).

Protection equipment

Motor starter protectors/circuit breakers

SIRIUS 3RV2 motor starter protectors/circuit breakers

For motor protection **IE3/IE4 ready** **AC-3e**

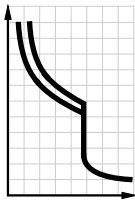

CLASS 20, with transverse auxiliary switch (1 NO + 1 NC)



3RV2031-4.B15,
14 to 45 A



3RV2031-4.B15,
52 to 65 A

Rated current	Suitable for three-phase motors ¹⁾ with P	Setting range for thermal overload release	Instantaneous electronic release	Short-circuit breaking capacity at 400 V AC	Screw terminals 	PU (UNIT, SET, M)	PS*	PG
I_n				I_{cu}	Article No.	Price per PU		
A	kW	A	A	kA				
Size S2								
14	5.5	9.5 ... 14	208	65	3RV2031-4SB15	1	1 unit	41E
17	7.5	12 ... 17	260	65	3RV2031-4TB15	1	1 unit	41E
20	7.5	14 ... 20	260	65	3RV2031-4BB15	1	1 unit	41E
25	11	18 ... 25	325	65	3RV2031-4DB15	1	1 unit	41E
32	15	22 ... 32	416	65	3RV2031-4EB15	1	1 unit	41E
36	18.5	28 ... 36	520	65	3RV2031-4PB15	1	1 unit	41E
40	18.5	32 ... 40	585	65	3RV2031-4UB15	1	1 unit	41E
45	22	35 ... 45	650	65	3RV2031-4VB15	1	1 unit	41E
52	22	42 ... 52	741	65	3RV2031-4WB15	1	1 unit	41E
59	30	49 ... 59	845	65	3RV2031-4XB15	1	1 unit	41E
65	30	54 ... 65	845	65	3RV2031-4JB15	1	1 unit	41E

¹⁾ Guide value for 4-pole standard motors at 50 Hz 400 V AC. The actual starting and rated data of the motor to be protected must be considered when selecting the units.

Auxiliary switches and other accessories can be ordered separately (see page 7/48 onwards).

Protection equipment

Motor starter protectors/circuit breakers

SIRIUS 3RV2 motor starter protectors/circuit breakers

AC-3e **IE3/IE4 ready** For motor protection with overload relay function

Selection and ordering data

CLASS 10, with overload relay function (automatic RESET), without auxiliary switches

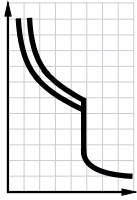

3RV2111-..A10



3RV2121-4.A10

Rated current	Suitable for three-phase motors ¹⁾ with P	Setting range for thermal overload release	Instantaneous electronic release	Short-circuit breaking capacity at 400 V AC	Screw terminals	PU (UNIT, SET, M)	PS*	PG
I_n				I_{cu}	Article No.	Price per PU		
A	kW	A	A	kA				
Size S0²⁾								
0.16	0.04	0.11 ... 0.16	2.1	100	3RV2111-0AA10	1	1 unit	41E
0.2	0.06	0.14 ... 0.2	2.6	100	3RV2111-0BA10	1	1 unit	41E
0.25	0.06	0.18 ... 0.25	3.3	100	3RV2111-0CA10	1	1 unit	41E
0.32	0.09	0.22 ... 0.32	4.2	100	3RV2111-0DA10	1	1 unit	41E
0.4	0.09	0.28 ... 0.4	5.2	100	3RV2111-0EA10	1	1 unit	41E
0.5	0.12	0.35 ... 0.5	6.5	100	3RV2111-0FA10	1	1 unit	41E
0.63	0.18	0.45 ... 0.63	8.2	100	3RV2111-0GA10	1	1 unit	41E
0.8	0.18	0.55 ... 0.8	10	100	3RV2111-0HA10	1	1 unit	41E
1	0.25	0.7 ... 1	13	100	3RV2111-0JA10	1	1 unit	41E
1.25	0.37	0.9 ... 1.25	16	100	3RV2111-0KA10	1	1 unit	41E
1.6	0.55	1.1 ... 1.6	21	100	3RV2111-1AA10	1	1 unit	41E
2	0.75	1.4 ... 2	26	100	3RV2111-1BA10	1	1 unit	41E
2.5	0.75	1.8 ... 2.5	33	100	3RV2111-1CA10	1	1 unit	41E
3.2	1.1	2.2 ... 3.2	42	100	3RV2111-1DA10	1	1 unit	41E
4	1.5	2.8 ... 4	52	100	3RV2111-1EA10	1	1 unit	41E
5	1.5	3.5 ... 5	65	100	3RV2111-1FA10	1	1 unit	41E
6.3	2.2	4.5 ... 6.3	82	100	3RV2111-1GA10	1	1 unit	41E
8	3	5.5 ... 8	104	100	3RV2111-1HA10	1	1 unit	41E
10	4	7 ... 10	130	100	3RV2111-1JA10	1	1 unit	41E
12.5	5.5	9 ... 12.5	163	100	3RV2111-1KA10	1	1 unit	41E
16	7.5	10 ... 16	208	55	3RV2111-4AA10	1	1 unit	41E
Size S0²⁾								
16	7.5	10 ... 16	208	55	3RV2121-4AA10	1	1 unit	41E
20	7.5	13 ... 20	260	55	3RV2121-4BA10	1	1 unit	41E
22	11	16 ... 22	286	55	3RV2121-4CA10	1	1 unit	41E
25	11	18 ... 25	325	55	3RV2121-4DA10	1	1 unit	41E
28	15	23 ... 28	364	55	3RV2121-4NA10	1	1 unit	41E
32 ³⁾	15	27 ... 32	400	55	3RV2121-4EA10	1	1 unit	41E

¹⁾ Guide value for 4-pole standard motors at 50 Hz 400 V AC. The actual starting and rated data of the motor to be protected must be considered when selecting the units.

²⁾ Accessories for mounting on the right and 3RV1915 3-phase busbars cannot be used.

³⁾ Suitable for use with IE3 and IE4 motors up to a starting current of 256 A. For higher starting currents we recommend using 3RV2 motor starter protectors size S2.

Auxiliary switches and other accessories can be ordered separately (see page 7/48 onwards).

Protection equipment

Motor starter protectors/circuit breakers

SIRIUS 3RV2 motor starter protectors/circuit breakers

For motor protection with overload relay function **IE3/IE4 ready** **AC-3e**

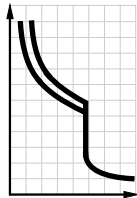

CLASS 10, with overload relay function (Automatic RESET), without auxiliary switches



3RV2131-4.A10



3RV2142-4.A10

Rated current	Suitable for three-phase motors ¹⁾ with P	Setting range for thermal overload release	Instantaneous electronic release	Short-circuit breaking capacity at 400 V AC	Screw terminals 	PU (UNIT, SET, M)	PS*	PG
I_n				I_{cu}	Article No.	Price per PU		
A	kW	A	A	kA				
Size S2²⁾								
14	5.5	9.5 ... 14	208	65	3RV2131-4SA10	1	1 unit	41E
17	7.5	12 ... 17	260	65	3RV2131-4TA10	1	1 unit	41E
20	7.5	14 ... 20	260	65	3RV2131-4BA10	1	1 unit	41E
25	11	18 ... 25	325	65	3RV2131-4DA10	1	1 unit	41E
32	15	22 ... 32	416	65	3RV2131-4EA10	1	1 unit	41E
36	18.5	28 ... 36	520	65	3RV2131-4PA10	1	1 unit	41E
40	18.5	32 ... 40	585	65	3RV2131-4UA10	1	1 unit	41E
45	22	35 ... 45	650	65	3RV2131-4VA10	1	1 unit	41E
52	32	42 ... 52	741	65	3RV2131-4WA10	1	1 unit	41E
59	30	49 ... 59	845	65	3RV2131-4XA10	1	1 unit	41E
65	30	54 ... 65	845	65	3RV2131-4JA10	1	1 unit	41E
73	37	62 ... 73	949	65	3RV2131-4KA10	1	1 unit	41E
80 ³⁾	37	70 ... 80	1 040	65	3RV2131-4RA10	1	1 unit	41E
Size S3, with increased switching capacity²⁾								
40	18.5	28 ... 40	520	100	3RV2142-4FA10	1	1 unit	41E
50	22	36 ... 50	650	100	3RV2142-4HA10	1	1 unit	41E
63	30	45 ... 63	819	100	3RV2142-4JA10	1	1 unit	41E
75	37	57 ... 75	975	100	3RV2142-4KA10	1	1 unit	41E
84	45	65 ... 84	1 170	100	3RV2142-4RA10	1	1 unit	41E
93	45	75 ... 93	1 300	100	3RV2142-4YA10	1	1 unit	41E
100 ⁴⁾	45, 55	80 ... 100	1 300	100	3RV2142-4MA10	1	1 unit	41E

¹⁾ Guide value for 4-pole standard motors at 50 Hz 400 V AC. The actual starting and rated data of the motor to be protected must be considered when selecting the units.

²⁾ Accessories for mounting on the right cannot be used.

³⁾ Suitable for use with IE3 and IE4 motors up to a starting current of 720 A. For higher starting currents we recommend using 3RV2 motor starter protectors size S3.

⁴⁾ Suitable for use with IE3 and IE4 motors up to a starting current of 780 A. For higher starting currents we recommend using 3VA circuit breakers (see Catalog LV 10).

Auxiliary switches and other accessories can be ordered separately (see page 7/48 onwards).

Protection equipment

Motor starter protectors/circuit breakers

SIRIUS 3RV2 motor starter protectors/circuit breakers

AC-3e

IE3/IE4 ready

For starter combinations

Selection and ordering data

Without auxiliary switches

PU (UNIT, SET, M) = 1
 PS* = 1 unit
 PG = 41E

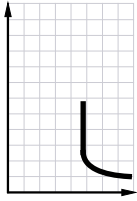

3RV2311-..C10

3RV2311-..C20,
3RV2311-4AC20-0BA0

Rated current I_n A	Suitable for three-phase motors with P kW	Thermal overload release ²⁾ A	Instantaneous electronic release $I >$ A	Short-circuit breaking capacity at 400 V AC I_{cu} kA	Screw terminals		Spring-loaded terminals	
					Article No.	Price per PU	Article No.	Price per PU
Size S00								
0.16	0.04	Without	2.1	100	3RV2311-0AC10		3RV2311-0AC20	
0.2	0.06	Without	2.6	100	3RV2311-0BC10		3RV2311-0BC20	
0.25	0.06	Without	3.3	100	3RV2311-0CC10		3RV2311-0CC20	
0.32	0.09	Without	4.2	100	3RV2311-0DC10		3RV2311-0DC20	
0.4	0.09	Without	5.2	100	3RV2311-0EC10		3RV2311-0EC20	
0.5	0.12	Without	6.5	100	3RV2311-0FC10		3RV2311-0FC20	
0.63	0.18	Without	8.2	100	3RV2311-0GC10		3RV2311-0GC20	
0.8	0.18	Without	10	100	3RV2311-0HC10		3RV2311-0HC20	
1	0.25	Without	13	100	3RV2311-0JC10		3RV2311-0JC20	
1.25	0.37	Without	16	100	3RV2311-0KC10		3RV2311-0KC20	
1.6	0.55	Without	21	100	3RV2311-1AC10		3RV2311-1AC20	
2	0.75	Without	26	100	3RV2311-1BC10		3RV2311-1BC20	
2.5	0.75	Without	33	100	3RV2311-1CC10		3RV2311-1CC20	
3.2	1.1	Without	42	100	3RV2311-1DC10		3RV2311-1DC20	
4	1.5	Without	52	100	3RV2311-1EC10		3RV2311-1EC20	
5	1.5	Without	65	100	3RV2311-1FC10		3RV2311-1FC20	
6.3	2.2	Without	82	100	3RV2311-1GC10		3RV2311-1GC20	
8	3	Without	104	100	3RV2311-1HC10		3RV2311-1HC20	
10	4	Without	130	100	3RV2311-1JC10		3RV2311-1JC20	
12.5	5.5	Without	163	100	3RV2311-1KC10		3RV2311-1KC20	
16	7.5	Without	208	55	3RV2311-4AC10		3RV2311-4AC20	

For special operating conditions down to -50 °C³⁾⁴⁾

16	7.5	Without	208	55	--		3RV2311-4AC20-0BA0	
----	-----	---------	-----	----	----	--	--------------------	--

- 1) Guide value for 4-pole standard motors at 50 Hz 400 V AC. The actual starting and rated data of the motor to be protected must be considered when selecting the units.
- 2) For overload protection of the motors, appropriate overload relays must be used.
- 3) The 3RV2311-.....-0BA0 motor starter protectors have a mechanical endurance of 500 operating cycles.
- 4) The motor starter protectors do not have UL/CSA approval and are not certified either according to the European Explosion Protection Directive (ATEX) or according to the International Explosion Protection Standard (IECEx).

Auxiliary switches and other accessories can be ordered separately (see page 7/48 onwards).

Protection equipment

Motor starter protectors/circuit breakers

SIRIUS 3RV2 motor starter protectors/circuit breakers

For starter combinations

IE3/IE4 ready

AC-3e

Without auxiliary switches

PU (UNIT, SET, M) = 1
 PS* = 1 unit
 PG = 41E

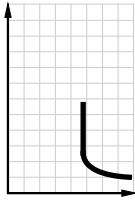

3RV2321-...C10



3RV2321-...C20,
3RV2321-4AC20-0BA0

Rated current I_n A	Suitable for three-phase motors ¹⁾ with P kW	Thermal overload release ²⁾ A	Instantaneous electronic release $I >$ A	Short-circuit breaking capacity at 400 V AC I_{cu} kA	Screw terminals		Spring-loaded terminals	
					Article No.	Price per PU	Article No.	Price per PU
Size S0								
1.6	0.55	Without	21	100	3RV2321-1AC10		3RV2321-1AC20	
2	0.75	Without	26	100	3RV2321-1BC10		3RV2321-1BC20	
2.5	0.75	Without	33	100	3RV2321-1CC10		3RV2321-1CC20	
3.2	1.1	Without	42	100	3RV2321-1DC10		3RV2321-1DC20	
4	1.5	Without	52	100	3RV2321-1EC10		3RV2321-1EC20	
5	1.5	Without	65	100	3RV2321-1FC10		3RV2321-1FC20	
6.3	2.2	Without	82	100	3RV2321-1GC10		3RV2321-1GC20	
8	3	Without	104	100	3RV2321-1HC10		3RV2321-1HC20	
10	4	Without	130	100	3RV2321-1JC10		3RV2321-1JC20	
12.5	5.5	Without	163	100	3RV2321-1KC10		3RV2321-1KC20	
16	7.5	Without	208	55	3RV2321-4AC10		3RV2321-4AC20	
20	7.5	Without	260	55	3RV2321-4BC10		3RV2321-4BC20	
22	11	Without	286	55	3RV2321-4CC10		3RV2321-4CC20	
25	11	Without	325	55	3RV2321-4DC10		3RV2321-4DC20	
28	15	Without	364	55	3RV2321-4NC10		3RV2321-4NC20	
32 ³⁾	15	Without	400	55	3RV2321-4EC10		3RV2321-4EC20	
36 ⁴⁾	18.5	Without	432	20	3RV2321-4PC10		--	
40 ⁴⁾	18.5	Without	480	20	3RV2321-4FC10		--	

For special operating conditions down to -50 °C⁵⁾⁶⁾

16	7.5	Without	208	55	--	3RV2321-4AC20-0BA0
----	-----	---------	-----	----	----	--------------------

- 1) Guide value for 4-pole standard motors at 50 Hz 400 V AC. The actual starting and rated data of the motor to be protected must be considered when selecting the units.
- 2) For overload protection of the motors, appropriate overload relays must be used.
- 3) Suitable for use with IE3 and IE4 motors up to a starting current of 256 A. For higher starting currents we recommend using 3RV2 motor starter protectors size S2.
- 4) The devices must not be mounted side-by-side and they must not be assembled with link modules with contactors. A lateral clearance of 9 mm is required. For use with IE3 and IE4 motors we recommend using 3RV2 motor starter protectors size S2.
- 5) The 3RV2321-...-0BA0 motor starter protectors have a mechanical endurance of 500 operating cycles.
- 6) The motor starter protectors do not have UL/CSA approval and are not certified either according to the European Explosion Protection Directive (ATEX) or according to the International Explosion Protection Standard (IECEx).

Auxiliary switches and other accessories can be ordered separately (see page 7/48 onwards).

Protection equipment

Motor starter protectors/circuit breakers

SIRIUS 3RV2 motor starter protectors/circuit breakers

AC-3e **IE3/IE4 ready** For starter combinations

Without auxiliary switches

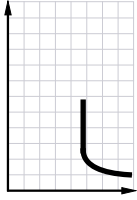



 3RV2331-4.C10,
14 to 45 A

 3RV2331-4.C10,
52 to 80 A

 3RV2332-4.C10,
14 to 45 A

 3RV2332-4.C10,
52 to 80 A

 3RV234-.4.C10,
40 to 100 A

Rated current	Suitable for three-phase motors ¹⁾ with P	Thermal overload release ²⁾	Instantaneous electronic release	Short-circuit breaking capacity at 400 V AC	Screw terminals 	PU (UNIT, SET, M)	PS*	PG
I_n				I_{cu}	Article No.	Price per PU		
A	kW	A	A	kA				
Size S2								
14	5.5	Without	208	65	3RV2331-4SC10	1	1 unit	41E
17	7.5	Without	260	65	3RV2331-4TC10	1	1 unit	41E
20	7.5	Without	260	65	3RV2331-4BC10	1	1 unit	41E
25	11	Without	325	65	3RV2331-4DC10	1	1 unit	41E
32	15	Without	416	65	3RV2331-4EC10	1	1 unit	41E
36	18.5	Without	520	65	3RV2331-4PC10	1	1 unit	41E
40	18.5	Without	585	65	3RV2331-4UC10	1	1 unit	41E
45	22	Without	650	65	3RV2331-4VC10	1	1 unit	41E
52	22	Without	741	65	3RV2331-4WC10	1	1 unit	41E
59	30	Without	845	65	3RV2331-4XC10	1	1 unit	41E
65	30	Without	845	65	3RV2331-4JC10	1	1 unit	41E
73	37	Without	949	65	3RV2331-4KC10	1	1 unit	41E
80 ³⁾	37	Without	1040	65	3RV2331-4RC10	1	1 unit	41E
Size S2, with increased switching capacity								
14	5.5	Without	208	100	3RV2332-4SC10	1	1 unit	41E
17	7.5	Without	260	100	3RV2332-4TC10	1	1 unit	41E
20	7.5	Without	260	100	3RV2332-4BC10	1	1 unit	41E
25	11	Without	325	100	3RV2332-4DC10	1	1 unit	41E
32	15	Without	416	100	3RV2332-4EC10	1	1 unit	41E
36	18.5	Without	520	100	3RV2332-4PC10	1	1 unit	41E
40	18.5	Without	585	100	3RV2332-4UC10	1	1 unit	41E
45	22	Without	650	100	3RV2332-4VC10	1	1 unit	41E
52	22	Without	741	100	3RV2332-4WC10	1	1 unit	41E
59	30	Without	845	100	3RV2332-4XC10	1	1 unit	41E
65	30	Without	845	100	3RV2332-4JC10	1	1 unit	41E
73	37	Without	949	100	3RV2332-4KC10	1	1 unit	41E
80 ³⁾	37	Without	1 040	100	3RV2332-4RC10	1	1 unit	41E
Size S3								
40	18.5	Without	520	65	3RV2341-4FC10	1	1 unit	41E
50	22	Without	650	65	3RV2341-4HC10	1	1 unit	41E
63	30	Without	819	65	3RV2341-4JC10	1	1 unit	41E
75	37	Without	975	65	3RV2341-4KC10	1	1 unit	41E
84	45	Without	1 170	65	3RV2341-4RC10	1	1 unit	41E
93	45	Without	1 300	65	3RV2341-4YC10	1	1 unit	41E
100 ⁴⁾	45, 55	Without	1 300	65	3RV2341-4MC10	1	1 unit	41E
Size S3, with increased switching capacity								
40	18.5	Without	520	100	3RV2342-4FC10	1	1 unit	41E
50	22	Without	650	100	3RV2342-4HC10	1	1 unit	41E
63	30	Without	819	100	3RV2342-4JC10	1	1 unit	41E
75	37	Without	975	100	3RV2342-4KC10	1	1 unit	41E
84	45	Without	1 170	100	3RV2342-4RC10	1	1 unit	41E
93	45	Without	1 300	100	3RV2342-4YC10	1	1 unit	41E
100 ⁴⁾	45, 55	Without	1 300	100	3RV2342-4MC10	1	1 unit	41E

¹⁾ Guide value for 4-pole standard motors at 50 Hz 400 V AC. The actual starting and rated data of the motor to be protected must be considered when selecting the units.

²⁾ For overload protection of the motors, appropriate overload relays must be used.

³⁾ Suitable for use with IE3 and IE4 motors up to a starting current of 720 A. For higher starting currents we recommend using 3RV2 motor starter protectors size S3.

⁴⁾ Suitable for use with IE3 and IE4 motors up to a starting current of 780 A. For higher starting currents we recommend using 3VA circuit breakers (see Catalog LV 10).

Auxiliary switches and other accessories can be ordered separately (see page 7/48 onwards).

Protection equipment

Motor starter protectors/circuit breakers

SIRIUS 3RV2 motor starter protectors/circuit breakers

For transformer protection

Selection and ordering data

CLASS 10, without auxiliary switches

Motor starter protectors for the protection of transformers with high inrush current



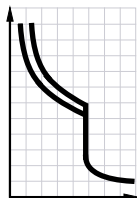

PU (UNIT, SET, M) = 1
 PS* = 1 unit
 PG = 41E



3RV2411-..A10,
3RV2411-..A10-0BA0



3RV2411-..A20

Rated current	Setting range for thermal overload release	Instantaneous electronic release	Short-circuit breaking capacity at 400 V AC	Screw terminals 	Spring-loaded terminals 
I_n			I_{cu}	Article No.	Price per PU
A	A	A	kA	Article No.	Price per PU
Size S00					
0.16	0.11 ... 0.16	3.3	100	3RV2411-0AA10	3RV2411-0AA20
0.2	0.14 ... 0.2	4.2	100	3RV2411-0BA10	3RV2411-0BA20
0.25	0.18 ... 0.25	5.2	100	3RV2411-0CA10	3RV2411-0CA20
0.32	0.22 ... 0.32	6.5	100	3RV2411-0DA10	3RV2411-0DA20
0.4	0.28 ... 0.4	8.2	100	3RV2411-0EA10	3RV2411-0EA20
0.5	0.35 ... 0.5	10	100	3RV2411-0FA10	3RV2411-0FA20
0.63	0.45 ... 0.63	13	100	3RV2411-0GA10	3RV2411-0GA20
0.8	0.55 ... 0.8	16	100	3RV2411-0HA10	3RV2411-0HA20
1	0.7 ... 1	21	100	3RV2411-0JA10	3RV2411-0JA20
1.25	0.9 ... 1.25	26	100	3RV2411-0KA10	3RV2411-0KA20
1.6	1.1 ... 1.6	33	100	3RV2411-1AA10	3RV2411-1AA20
2	1.4 ... 2	42	100	3RV2411-1BA10	3RV2411-1BA20
2.5	1.8 ... 2.5	52	100	3RV2411-1CA10	3RV2411-1CA20
3.2	2.2 ... 3.2	65	100	3RV2411-1DA10	3RV2411-1DA20
4	2.8 ... 4	82	100	3RV2411-1EA10	3RV2411-1EA20
5	3.5 ... 5	104	100	3RV2411-1FA10	3RV2411-1FA20
6.3	4.5 ... 6.3	130	100	3RV2411-1GA10	3RV2411-1GA20
8	5.5 ... 8	163	100	3RV2411-1HA10	3RV2411-1HA20
10	7 ... 10	208	100	3RV2411-1JA10	3RV2411-1JA20
12.5	9 ... 12.5	260	100	3RV2411-1KA10	3RV2411-1KA20
16	10 ... 16	286	55	3RV2411-4AA10	3RV2411-4AA20

Without phase asymmetry/failure detection for 1-, 2- and 3-phase loads¹⁾

0.4	0.28 ... 0.4	8.2	100	--	3RV2411-0EA20-0DA0
1.6	1.1 ... 1.6	33	100	--	3RV2411-1AA20-0DA0
2	1.4 ... 2	42	100	--	3RV2411-1BA20-0DA0
2.5	1.8 ... 2.5	52	100	--	3RV2411-1CA20-0DA0
3.2	2.2 ... 3.2	65	100	--	3RV2411-1DA20-0DA0
4	2.8 ... 4	82	100	--	3RV2411-1EA20-0DA0
5	3.5 ... 5	104	100	--	3RV2411-1FA20-0DA0
6.3	4.5 ... 6.3	130	100	--	3RV2411-1GA20-0DA0
8	5.5 ... 8	163	100	--	3RV2411-1HA20-0DA0
10	7 ... 10	208	100	--	3RV2411-1JA20-0DA0

For special operating conditions down to -50 °C²⁾³⁾

2.5	1.8 ... 2.5	52	100	3RV2411-1CA10-0BA0	--
6.3	4.5 ... 6.3	130	100	3RV2411-1GA10-0BA0	--
8	5.5 ... 8	163	100	3RV2411-1HA10-0BA0	--
10	7 ... 10	208	100	3RV2411-1JA10-0BA0	--
16	10 ... 16	286	55	3RV2411-4AA10-0BA0	--

¹⁾ The motor starter protectors do not have UL/CSA approval and are not certified either according to the European Explosion Protection Directive (ATEX) or according to the International Explosion Protection Standard (IECEx).

²⁾ The motor starter protectors have IEC approval, but not UL/CSA approval.

³⁾ The 3RV2411-....-0BA0 motor starter protectors have a mechanical endurance of 500 operating cycles.

Auxiliary switches and other accessories can be ordered separately (see page 7/48 onwards).

Protection equipment

Motor starter protectors/circuit breakers

SIRIUS 3RV2 motor starter protectors/circuit breakers

For transformer protection

CLASS 10, without auxiliary switches

Motor starter protectors for the protection of transformers with high inrush current

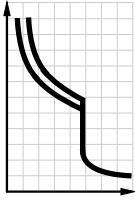

PU (UNIT, SET, M) = 1
 PS* = 1 unit
 PG = 41E



3RV2421-...A10,
3RV2421-4BA10-0BA0,
32 A



3RV2421-4.A20;
3RV2421-4.A20-0DA0,
16 and 20 A

Rated current I_n A	Setting range for thermal overload release 	Instantaneous electronic release $I >$ A	Short-circuit breaking capacity at 400 V AC I_{cu} kA	Screw terminals 		Spring-loaded terminals 	
				Article No.	Price per PU	Article No.	Price per PU
Size S0							
0.16	0.11 ... 0.16	3.3	100	3RV2421-0AA10		--	
0.2	0.14 ... 0.2	4.2	100	3RV2421-0BA10		--	
0.25	0.18 ... 0.25	5.2	100	3RV2421-0CA10		--	
0.32	0.22 ... 0.32	6.5	100	3RV2421-0DA10		--	
0.4	0.28 ... 0.4	8.2	100	3RV2421-0EA10		--	
0.5	0.35 ... 0.5	10	100	3RV2421-0FA10		--	
0.63	0.45 ... 0.63	13	100	3RV2421-0GA10		--	
0.8	0.55 ... 0.8	16	100	3RV2421-0HA10		--	
1	0.7 ... 1	21	100	3RV2421-0JA10		--	
1.25	0.9 ... 1.25	26	100	3RV2421-0KA10		--	
1.6	1.1 ... 1.6	33	100	3RV2421-1AA10		--	
2	1.4 ... 2	42	100	3RV2421-1BA10		--	
2.5	1.8 ... 2.5	52	100	3RV2421-1CA10		--	
3.2	2.2 ... 3.2	65	100	3RV2421-1DA10		--	
4	2.8 ... 4	82	100	3RV2421-1EA10		--	
5	3.5 ... 5	104	100	3RV2421-1FA10		--	
6.3	4.5 ... 6.3	130	100	3RV2421-1GA10		--	
8	5.5 ... 8	163	100	3RV2421-1HA10		--	
10	7 ... 10	208	100	3RV2421-1JA10		--	
12.5	9 ... 12.5	260	100	3RV2421-1KA10		--	
16	10 ... 16	286	55	3RV2421-4AA10		3RV2421-4AA20	
20	13 ... 20	325	55	3RV2421-4BA10		3RV2421-4BA20	
22	16 ... 22	364	55	3RV2421-4CA10		3RV2421-4CA20	
25	18 ... 25	400	55	3RV2421-4DA10		3RV2421-4DA20	

Without phase asymmetry/failure detection for 1-, 2- and 3-phase loads¹⁾

16	10 ... 16	286	55	--	3RV2421-4AA20-0DA0
20	13 ... 20	325	55	--	3RV2421-4BA20-0DA0

For special operating conditions down to -50 °C²⁾³⁾

20	13 ... 20	325	55	3RV2421-4BA10-0BA0	--
----	-----------	-----	----	--------------------	----

¹⁾ The motor starter protectors do not have UL/CSA approval and are not certified either according to the European Explosion Protection Directive (ATEX) or according to the International Explosion Protection Standard (IECEx).

²⁾ The motor starter protectors have IEC approval, but not UL/CSA approval.

³⁾ The 3RV2431-...-0BA0 motor starter protectors have a mechanical endurance of 250 operating cycles.

Auxiliary switches and other accessories can be ordered separately (see page 7/48 onwards).

Protection equipment

Motor starter protectors/circuit breakers

SIRIUS 3RV2 motor starter protectors/circuit breakers

For transformer protection

CLASS 10, without auxiliary switches



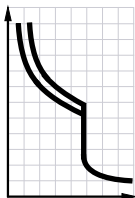

Motor starter protectors for the protection of transformers with high inrush current

PU (UNIT, SET, M) = 1
 PS* = 1 unit
 PG = 41E



3RV2431-4.A10,
14 to 40 A;
3RV2431-4EA10-0BA0,
32 A

3RV2431-4.A10,
45 to 65 A

Rated current	Setting range for thermal overload release	Instantaneous electronic release	Short-circuit breaking capacity at 400 V AC	Screw terminals 	Spring-loaded terminals 		
I_n			I_{cu}	Article No.	Price per PU	Article No.	Price per PU
A	A	A	kA				
Size S2							
14	9.5 ... 14	328	65	3RV2431-4SA10		--	
17	12 ... 17	410	65	3RV2431-4TA10		--	
20	14 ... 20	410	65	3RV2431-4BA10		--	
25	18 ... 25	512	65	3RV2431-4DA10		--	
32	22 ... 32	656	65	3RV2431-4EA10		--	
36	28 ... 36	820	65	3RV2431-4PA10		--	
40	32 ... 40	820	65	3RV2431-4UA10		--	
45	35 ... 45	922	65	3RV2431-4VA10		--	
52	42 ... 52	1 025	65	3RV2431-4WA10		--	
59	49 ... 59	1 040	65	3RV2431-4XA10		--	
65	54 ... 65	1 040	65	3RV2431-4JA10		--	

For special operating conditions down to -50 °C¹⁾²⁾

32	22 ... 32	656	65	3RV2431-4EA10-0BA0		--	
----	-----------	-----	----	---------------------------	--	----	--

¹⁾ The motor starter protectors do not have UL/CSA approval and are not certified either according to the European Explosion Protection Directive (ATEX) or according to the International Explosion Protection Standard (IECx).

²⁾ The 3RV2431-.....-0BA0 motor starter protectors have a mechanical endurance of 250 operating cycles.

Auxiliary switches and other accessories can be ordered separately (see page 7/48 onwards).

Protection equipment

Motor starter protectors/circuit breakers

SIRIUS 3RV2 motor starter protectors/circuit breakers

For transformer protection

CLASS 10, with transverse auxiliary switch (1 NO + 1 NC)

Motor starter protectors for the protection of transformers with high inrush current

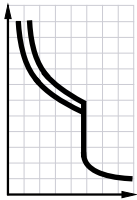

3RV2411-...A15



3RV2421-4.A15

Rated current	Setting range for thermal overload release	Instantaneous electronic release	Short-circuit breaking capacity at 400 V AC	Screw terminals	PU (UNIT, SET, M)	PS*	PG
I_n		$I >$	I_{cu}	Article No.	Price per PU		
A	A	A	kA				
Size S00							
0.16	0.11 ... 0.16	3.3	100	3RV2411-0AA15	1	1 unit	41E
0.2	0.14 ... 0.2	4.2	100	3RV2411-0BA15	1	1 unit	41E
0.25	0.18 ... 0.25	5.2	100	3RV2411-0CA15	1	1 unit	41E
0.32	0.22 ... 0.32	6.5	100	3RV2411-0DA15	1	1 unit	41E
0.4	0.28 ... 0.4	8.2	100	3RV2411-0EA15	1	1 unit	41E
0.5	0.35 ... 0.5	10	100	3RV2411-0FA15	1	1 unit	41E
0.63	0.45 ... 0.63	13	100	3RV2411-0GA15	1	1 unit	41E
0.8	0.55 ... 0.8	16	100	3RV2411-0HA15	1	1 unit	41E
1	0.7 ... 1	21	100	3RV2411-0JA15	1	1 unit	41E
1.25	0.9 ... 1.25	26	100	3RV2411-0KA15	1	1 unit	41E
1.6	1.1 ... 1.6	33	100	3RV2411-1AA15	1	1 unit	41E
2	1.4 ... 2	42	100	3RV2411-1BA15	1	1 unit	41E
2.5	1.8 ... 2.5	52	100	3RV2411-1CA15	1	1 unit	41E
3.2	2.2 ... 3.2	65	100	3RV2411-1DA15	1	1 unit	41E
4	2.8 ... 4	82	100	3RV2411-1EA15	1	1 unit	41E
5	3.5 ... 5	104	100	3RV2411-1FA15	1	1 unit	41E
6.3	4.5 ... 6.3	130	100	3RV2411-1GA15	1	1 unit	41E
8	5.5 ... 8	163	100	3RV2411-1HA15	1	1 unit	41E
10	7 ... 10	208	100	3RV2411-1JA15	1	1 unit	41E
12.5	9 ... 12.5	260	100	3RV2411-1KA15	1	1 unit	41E
16	10 ... 16	286	55	3RV2411-4AA15	1	1 unit	41E
Size S0							
16	10 ... 16	286	55	3RV2421-4AA15	1	1 unit	41E
20	13 ... 20	325	55	3RV2421-4BA15	1	1 unit	41E
22	16 ... 22	364	55	3RV2421-4CA15	1	1 unit	41E
25	18 ... 25	400	55	3RV2421-4DA15	1	1 unit	41E

Auxiliary switches and other accessories can be ordered separately (see page 7/48 onwards).

Protection equipment

Motor starter protectors/circuit breakers

SIRIUS 3RV2 motor starter protectors/circuit breakers

For system protection

Selection and ordering data

CLASS 10, without auxiliary switches

The motor starter protectors are suitable for 1-, 2- and 3-phase loads and do not feature phase asymmetry and phase failure detection. They do not have UL/CSA approval and are not certified either according to the European Explosion Protection Directive (ATEX) or according to the International Explosion Protection Standard (IECEx).

PU (UNIT, SET, M) = 1
PS* = 1 unit
PG = 41E

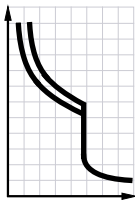





3RV2021-..A10-0DA0



3RV2021-1EA20-0DA0



3RV2041-4.A10-0DA0

Rated current	Suitable for three-phase motors ¹⁾ with ▶	Setting range for thermal overload release	Instantaneous electronic release	Short-circuit breaking capacity at 400 V AC	Screw terminals 	Spring-loaded terminals 
I_n				I_{cu}	Article No.	Article No.
A	kW	A	A	kA	Price per PU	Price per PU
Size S0						
4	1.5	2.8 ... 4	52	100	3RV2021-1EA10-0DA0	3RV2021-1EA20-0DA0
6.3	2.2	4.5 ... 6.3	82	100	3RV2021-1GA10-0DA0	--
8	3	5.5 ... 8	104	100	3RV2021-1HA10-0DA0	--
10	4	7 ... 10	130	100	3RV2021-1JA10-0DA0	--
12.5	5.5	9 ... 12.5	163	100	3RV2021-1KA10-0DA0	--
16	7.5	10 ... 16	208	55	3RV2021-4AA10-0DA0	--
20	7.5	13 ... 20	260	55	3RV2021-4BA10-0DA0	--
25	11	18 ... 25	325	55	3RV2021-4DA10-0DA0	--
32	15	27 ... 32	400	55	3RV2021-4EA10-0DA0	--
Size S3						
40	18.5	28 ... 40	520	65	3RV2041-4FA10-0DA0	--
50	22	36 ... 50	650	65	3RV2041-4HA10-0DA0	--
63	30	45 ... 63	819	65	3RV2041-4JA10-0DA0	--
84	45	65 ... 84	1 170	65	3RV2041-4RA10-0DA0	--
100	45, 55	80 ... 100	1 300	65	3RV2041-4MA10-0DA0	--

¹⁾ Guide value for 4-pole standard motors at 50 Hz 400 V AC. The actual starting and rated data of the motor to be protected must be considered when selecting the units.

Auxiliary switches and other accessories can be ordered separately (see page 7/48 onwards).

Protection equipment

Motor starter protectors/circuit breakers

SIRIUS 3RV2 motor starter protectors/circuit breakers

For system protection according to UL 489/CSA C22.2 No. 5

Selection and ordering data

Without auxiliary switches

Circuit breakers for system protection and non-motor loads according to UL/CSA

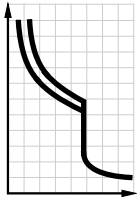

3RV2711-..D10



3RV2721-4.D10



3RV2742-5.D10

Rated current ¹⁾	Thermal overload release (non-adjustable)	Instantaneous electronic release	Short-circuit breaking capacity at 480 Y/277 V AC ²⁾ 480 V AC		Screw terminals	PU (UNIT, SET, M)	PS*	PG
I_n ¹⁾			I_{bc}		Article No.	Price per PU		
A	A	A	kA	kA				
Size S00								
0.16	0.16	2.1	65	--	3RV2711-0AD10	1	1 unit	41E
0.2	0.2	2.6	65	--	3RV2711-0BD10	1	1 unit	41E
0.25	0.25	3.3	65	--	3RV2711-0CD10	1	1 unit	41E
0.32	0.32	4.2	65	--	3RV2711-0DD10	1	1 unit	41E
0.4	0.4	5.2	65	--	3RV2711-0ED10	1	1 unit	41E
0.5	0.5	6.5	65	--	3RV2711-0FD10	1	1 unit	41E
0.63	0.63	8.2	65	--	3RV2711-0GD10	1	1 unit	41E
0.8	0.8	10	65	--	3RV2711-0HD10	1	1 unit	41E
1	1	13	65	--	3RV2711-0JD10	1	1 unit	41E
1.25	1.25	16	65	--	3RV2711-0KD10	1	1 unit	41E
1.6	1.6	21	65	--	3RV2711-1AD10	1	1 unit	41E
2	2	26	65	--	3RV2711-1BD10	1	1 unit	41E
2.5	2.5	33	65	--	3RV2711-1CD10	1	1 unit	41E
3.2	3.2	42	65	--	3RV2711-1DD10	1	1 unit	41E
4	4	52	65	--	3RV2711-1ED10	1	1 unit	41E
5	5	65	65	--	3RV2711-1FD10	1	1 unit	41E
6.3	6.3	82	65	--	3RV2711-1GD10	1	1 unit	41E
8	8	104	65	--	3RV2711-1HD10	1	1 unit	41E
10	10	130	65	--	3RV2711-1JD10	1	1 unit	41E
12.5	12.5	163	65	--	3RV2711-1KD10	1	1 unit	41E
15	15	208	65	--	3RV2711-4AD10	1	1 unit	41E
Size S0								
20	20	260	50	--	3RV2721-4BD10	1	1 unit	41E
22	22	286	50	--	3RV2721-4CD10	1	1 unit	41E
Size S3³⁾								
10	10	150	65	65	3RV2742-5AD10	1	1 unit	41E
15	15	225	65	65	3RV2742-5BD10	1	1 unit	41E
20	20	260	65	65	3RV2742-5CD10	1	1 unit	41E
25	25	325	65	65	3RV2742-5DD10	1	1 unit	41E
30	30	390	65	65	3RV2742-5ED10	1	1 unit	41E
35	35	455	65	--	3RV2742-5FD10	1	1 unit	41E
40	40	520	65	--	3RV2742-5GD10	1	1 unit	41E
45	45	585	65	--	3RV2742-5HD10	1	1 unit	41E
50	50	650	65	--	3RV2742-5JD10	1	1 unit	41E
60	60	780	65	--	3RV2742-5LD10	1	1 unit	41E
70	70	910	65	--	3RV2742-5QD10	1	1 unit	41E

¹⁾ Rated value 100% according to UL 489 and IEC 60947-2 (*100% rated breaker).

²⁾ Values for 600 Y/347 V AC, see page 7/17.

³⁾ Transverse auxiliary switches cannot be used for 3RV2742.

Lateral and transverse auxiliary switches can be ordered separately (see from page 7/48 onwards).

Protection equipment

Motor starter protectors/circuit breakers

SIRIUS 3RV2 motor starter protectors/circuit breakers

For transformer protection according to UL 489/CSA C22.2 No. 5

Selection and ordering data

Without auxiliary switches

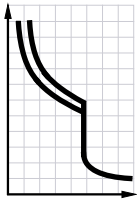

Circuit breakers for system and transformer protection according to UL/CSA, specially designed for transformers with high inrush current



3RV2811-.D10



3RV2821-4.D10

Rated current ¹⁾	Thermal overload release (non-adjustable)	Instantaneous electronic release	Short-circuit breaking capacity at 480 Y/277 V AC ²⁾	Screw terminals 	PU (UNIT, SET, M)	PS*	PG
I_n ¹⁾		$I >$	I_{bc}	Article No.	Price per PU		
A	A	A	kA				
Size S00							
0.16	0.16	3.3	65	3RV2811-0AD10		1	1 unit 41E
0.2	0.2	4.2	65	3RV2811-0BD10		1	1 unit 41E
0.25	0.25	5.2	65	3RV2811-0CD10		1	1 unit 41E
0.32	0.32	6.5	65	3RV2811-0DD10		1	1 unit 41E
0.4	0.4	8.2	65	3RV2811-0ED10		1	1 unit 41E
0.5	0.5	10	65	3RV2811-0FD10		1	1 unit 41E
0.63	0.63	13	65	3RV2811-0GD10		1	1 unit 41E
0.8	0.8	16	65	3RV2811-0HD10		1	1 unit 41E
1	1	21	65	3RV2811-0JD10		1	1 unit 41E
1.25	1.25	26	65	3RV2811-0KD10		1	1 unit 41E
1.6	1.6	33	65	3RV2811-1AD10		1	1 unit 41E
2	2	42	65	3RV2811-1BD10		1	1 unit 41E
2.5	2.5	52	65	3RV2811-1CD10		1	1 unit 41E
3.2	3.2	65	65	3RV2811-1DD10		1	1 unit 41E
4	4	82	65	3RV2811-1ED10		1	1 unit 41E
5	5	104	65	3RV2811-1FD10		1	1 unit 41E
6.3	6.3	130	65	3RV2811-1GD10		1	1 unit 41E
8	8	163	65	3RV2811-1HD10		1	1 unit 41E
10	10	208	65	3RV2811-1JD10		1	1 unit 41E
12.5	12.5	260	65	3RV2811-1KD10		1	1 unit 41E
15	15	286	65	3RV2811-4AD10		1	1 unit 41E
Size S0							
20	20	325	50	3RV2821-4BD10		1	1 unit 41E
22	22	364	50	3RV2821-4CD10		1	1 unit 41E

¹⁾ Rated value 100% according to UL 489 and IEC 60947-2 ("100% rated breaker").

²⁾ Values for 600 Y/347 V AC, see page 7/17.

Lateral and transverse auxiliary switches can be ordered separately (see from page 7/48 onwards).

Protection equipment

Motor starter protectors/circuit breakers

SIRIUS 3RV2 motor starter protectors/circuit breakers

Accessories > Mountable accessories

Overview

Mounting location and function

The 3RV2 motor starter protectors/circuit breakers have three main contact elements. In order to achieve maximum flexibility, auxiliary switches, signaling switches, auxiliary releases and isolator modules can be supplied separately.

These components are easily fitted to the switches without the use of any tools according to requirements.

Overview graphic, [see page 7/6](#).

<p>Front side</p> <p><u>Notes:</u></p> <ul style="list-style-type: none"> A maximum of four auxiliary contacts with auxiliary switches can be mounted on each motor starter protector/circuit breaker. Transverse auxiliary switches cannot be used for circuit breaker 3RV2742 (size S3). 	<p>Transverse auxiliary switches, solid-state compatible transverse auxiliary switches</p> <p>1 NO + 1 NC or 2 NO or 1 CO</p>	<p>An auxiliary switch can be inserted transversely on the front. The overall width of the motor starter protectors/circuit breakers remains unchanged.</p>
<p>Left-hand side</p> <p><u>Notes:</u></p> <ul style="list-style-type: none"> A maximum of four auxiliary contacts with auxiliary switches can be mounted on each motor starter protector/circuit breaker. Lateral auxiliary switches (two contacts) and signaling switches can be mounted separately or together. Signaling switches cannot be used for 3RV1011, 3RV27 and 3RV28 motor starter protectors/circuit breakers. Only lateral auxiliary switches can be used for 3RV2742 (size S3). 	<p>Lateral auxiliary switches (two contacts)</p> <p>1 NO + 1 NC or 2 NO or 2 NC</p> <p>Lateral auxiliary switches (four contacts)</p> <p>2 NO + 2 NC</p> <p>Signaling switches</p> <p>Tripping 1 NO + 1 NC Short circuit 1 NO + 1 NC</p>	<p>One of the three lateral auxiliary switches can be mounted on the left side per motor starter protector/circuit breaker. The contacts of the auxiliary switch close and open together with the main contacts of the motor starter protector/circuit breaker.</p> <p>The width of the lateral auxiliary switch with two contacts is 9 mm.</p> <p>One lateral auxiliary switch with four contacts can be mounted on the left side per motor starter protector/circuit breaker. The contacts of the auxiliary switch close and open together with the main contacts of the motor starter protector/circuit breaker.</p> <p>The width of the lateral auxiliary switch with four contacts is 18 mm.</p> <p>One signaling switch can be mounted on the left side of each motor starter protector.</p> <p>The signaling switch has two contact systems.</p> <p>One contact system always signals tripping irrespective of whether this was caused by a short circuit, an overload or an auxiliary release. The other contact system only switches in the event of a short circuit. There is no signaling as a result of switching off with the actuator.</p> <p>In order to be able to switch on the motor starter protector again after a short circuit, the signaling switch must be reset manually after the error cause has been eliminated.</p> <p>The width of the signaling switch is 18 mm.</p>
<p>Right-hand side</p> <p><u>Notes:</u></p> <ul style="list-style-type: none"> One auxiliary release can be mounted per motor starter protector/circuit breaker. Accessories cannot be mounted on the right-hand side of the 3RV21 motor starter protectors for motor protection with overload relay function. 	<p>Auxiliary releases</p> <p>Shunt releases</p> <p>or</p> <p>Undervoltage releases</p> <p>or</p> <p>Undervoltage releases with leading auxiliary contacts 2 NO Own version for 3RV1011</p>	<p>For remote-controlled tripping of the motor starter protector/circuit breaker. The release coil should only be energized for short periods (see circuit diagrams).</p> <p>Trips the motor starter protector/circuit breaker when the voltage is interrupted and prevents the motor from being restarted accidentally when the voltage is restored. Used for remote-controlled tripping of the motor starter protector/circuit breaker.</p> <p>Particularly suitable for EMERGENCY OFF disconnection by way of corresponding EMERGENCY OFF pushbuttons according to IEC 60204-1.</p> <p>Function and use as for the undervoltage release without leading auxiliary contacts, but with the following additional function: the auxiliary contacts will open in switch position OFF to deenergize the coil of the undervoltage release, thus interrupting energy consumption. In the "tripped" position, these auxiliary contacts are not guaranteed to open. The leading contacts permit the motor starter protector/circuit breaker to reclose.</p> <p>The width of the auxiliary release is 18 mm.</p>
<p>Top</p> <p><u>Notes:</u></p> <ul style="list-style-type: none"> Isolator modules cannot be used for 3RV1011, 3RV27 and 3RV28 motor starter protectors/circuit breakers. The isolator module for size S2 can be used only with 3RV2 motor starter protectors/circuit breakers up to max. 65 A. The isolator module cannot be used with the transverse auxiliary switch. 	<p>Isolator modules</p>	<p>Isolator modules can be mounted to the upper connection side of the motor starter protectors.</p> <p>The supply cable is connected to the motor starter protector through the isolator module.</p> <p>The plug can only be unplugged when the motor starter protector is open and isolates all 3 poles of the motor starter protector from the network. The shock-protected isolation point is clearly visible and secured with a padlock to prevent reinsertion of the plug.</p>

For a complete overview of which accessories can be used for the various motor starter protectors/circuit breakers, [see page 7/2](#).

Protection equipment













Motor starter protectors/circuit breakers

SIRIUS 3RV2 motor starter protectors/circuit breakers

Accessories > Mountable accessories

Selection and ordering data

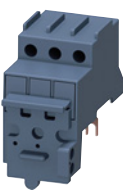
PU (UNIT, SET, M) = 1
 PS* = 1 unit (unless otherwise specified)
 PG = 41E

Version		For motor starter protectors/circuit breakers	Screw terminals 	Spring-loaded terminals 		
Size			Article No.	Price per PU	Article No.	Price per PU
Auxiliary switches¹⁾						
	Transverse auxiliary switches²⁾ For front mounting	S00 ... S3	3RV2901-1D 3RV2901-1E 3RV2901-1F		-- 3RV2901-2E 3RV2901-2F	
	Solid-state compatible transverse auxiliary switches²⁾ For mounting on the front, for operation in dusty atmosphere and in solid-state circuits with low operating currents					
	1 CO	S00 ... S3	3RV2901-1G		--	
	Covers for transverse auxiliary switches (PS* = 10 units)	S00 ... S3	3RV2901-0H		--	
	Lateral auxiliary switches For mounting on the left	S00 ... S3	3RV2901-1A 3RV2901-1B 3RV2901-1C 3RV2901-1J		3RV2901-2A 3RV2901-2B 3RV2901-2C --	
	1 NO + 1 NC 2 NO 2 NC 2 NO + 2 NC					
Signaling switches³⁾						
	Signaling switches One signaling switch can be mounted on the left per motor starter protector. Separate tripped and short-circuit alarms, 1 NO + 1 NC each	S00 ⁵⁾ ... S3	3RV2921-1M		3RV2921-2M	
						
Isolator modules³⁾⁴⁾						
	Isolator modules Visible isolating distance for isolating individual motor starter protectors from the network, lockable in disconnected position	S00 ⁵⁾ , S0 S2	3RV2928-1A 3RV2938-1A		-- --	
						

¹⁾ Each motor starter protector/circuit breaker can be fitted with one transverse and one lateral auxiliary switch. The lateral auxiliary switch with 2 NO + 2 NC is used without a transverse auxiliary switch.

²⁾ Not for 3RV2742 circuit breakers.

³⁾ This accessory cannot be used for the 3RV27 and 3RV28 circuit breakers (sizes S00, S0, S3).

⁴⁾ The isolator module for size S2 can be used only with 3RV2 motor starter protectors/circuit breakers up to max. 65 A. Similarly, it cannot be used with the transverse auxiliary switch

⁵⁾ Not for 3RV1011 motor starter protectors.

Protection equipment

Motor starter protectors/circuit breakers

SIRIUS 3RV2 motor starter protectors/circuit breakers

Accessories > Mountable accessories

PU (UNIT, SET, M) = 1
 PS* = 1 unit
 PG = 41E



3RV2902-1AV0



3RV2902-2AV0



3RV2922-1CP0



3RV2902-2DB0

Rated control supply voltage U_s					For motor starter protectors/circuit breakers	Screw terminals		Spring-loaded terminals	
AC 50 Hz	AC 60 Hz	AC 50/60 Hz	AC/DC 50/60 Hz, DC	DC		Article No.	Price per PU	Article No.	Price per PU
V	V	V	V	V	Size				
Auxiliary releases³⁾									
Undervoltage releases									
--	--	--	--	24	S00 ... S3	3RV2902-1AB4	--	--	--
24	24	--	--	--	S00 ... S3	3RV2902-1AB0	--	--	--
110	120	--	--	--	S00 ... S3	3RV2902-1AF0	--	--	--
--	208	--	--	--	S00 ... S3	3RV2902-1AM1	--	--	--
230	240	--	--	--	S00 ... S3	3RV2902-1AP0	--	3RV2902-2AP0	--
400	440	--	--	--	S00 ... S3	3RV2902-1AV0	--	3RV2902-2AV0	--
415	480	--	--	--	S00 ... S3	3RV2902-1AV1	--	--	--
500	600	--	--	--	S00 ... S3	3RV2902-1AS0	--	--	--
Undervoltage releases with leading auxiliary contacts 2 NO									
24	24	--	--	--	S00 ⁴⁾ ... S3	3RV2922-1CB0	--	--	--
230	240	--	--	--	S00 ⁴⁾ ... S3	3RV2922-1CP0	--	3RV2922-2CP0	--
400	440	--	--	--	S00 ⁴⁾ ... S3	3RV2922-1CV0	--	3RV2922-2CV0	--
415	480	--	--	--	S00 ⁴⁾ ... S3	3RV2922-1CV1	--	3RV2922-2CV1	--
Shunt releases									
--	--	20 ... 24	20 ... 70	--	S00 ... S3	3RV2902-1DB0	--	3RV2902-2DB0	--
--	--	90 ... 110	70 ... 190	--	S00 ... S3	3RV2902-1DF0	--	3RV2902-2DF0	--
--	--	210 ... 240	190 ... 330	--	S00 ... S3	3RV2902-1DP0	--	3RV2902-2DP0	--
--	--	350 ... 415	330 ... 500	--	S00 ... S3	3RV2902-1DV0	--	--	--
--	--	500	500	--	S00 ... S3	3RV2902-1DS0	--	--	--

¹⁾ The voltage range is valid for 100% (infinite) ON period. The response voltage lies at 0.9 of the lower limit of the voltage range.

²⁾ The voltage range is valid for 5 s ON period at 50/60 Hz AC and DC. The response voltage lies at 0.85 of the lower limit of the voltage range.

³⁾ One auxiliary release can be mounted on the right per motor starter protector/circuit breaker (does not apply to 3RV21 motor starter protectors/circuit breakers with overload relay function).

⁴⁾ Not for 3RV1011 motor starter protectors.

Protection equipment

Motor starter protectors/circuit breakers

SIRIUS 3RV2 motor starter protectors/circuit breakers

Accessories > Busbar accessories

Overview

Insulated 3-phase busbar system

3-phase busbar systems provide an easy, time-saving and clearly arranged means of feeding 3RV2 motor starter protectors/circuit breakers with screw terminals. Different versions are available for sizes S00 to S2 and can be used for the different types of motor starter protectors/circuit breakers (size S0 up to 32 A).

The 3RV1915 3-phase busbar systems are generally unsuitable for the 3RV21 motor starter protectors with sizes S00 and S0 for motor protection with overload relay function.

The busbars are suitable for between two and five motor starter protectors/circuit breakers. However, any kind of extension is possible by clamping the connection tags of an additional busbar (rotated by 180°) underneath the terminals of the respective last motor starter protector/circuit breaker.

A combination of motor starter protectors/circuit breakers of size S00 and S0 is possible. The motor starter protectors/circuit breakers are supplied by appropriate infeed terminals.

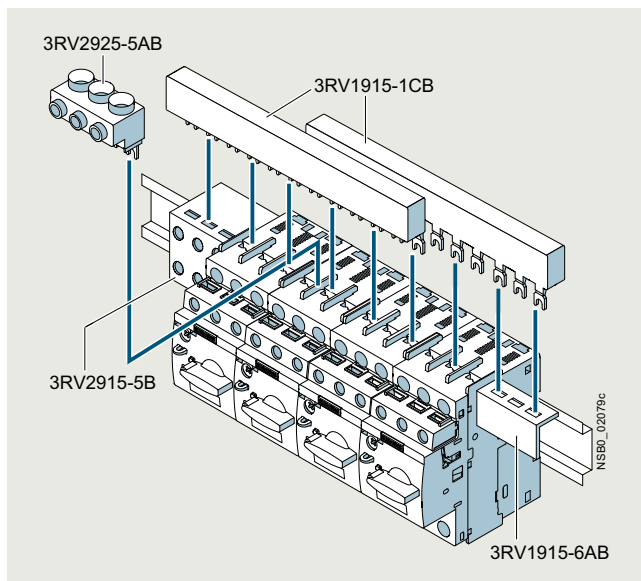

SIRIUS 3-phase busbar system size S00/S0

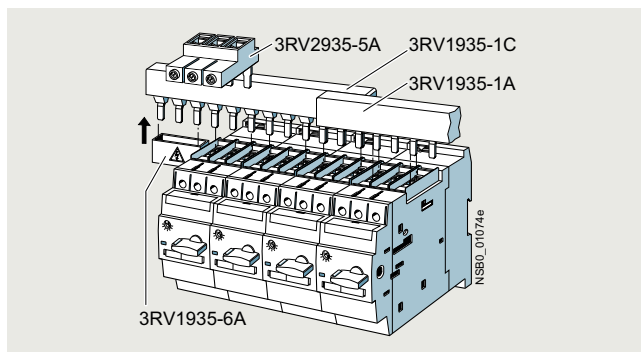

SIRIUS 3-phase busbar system size S2

The 3-phase busbar systems are finger-safe. They are designed for any short-circuit stress which can occur at the output side of connected motor starter protectors/circuit breakers.

The 3-phase busbar systems can also be used to construct "Starters (Type E)" according to UL/CSA and for 3RV27 and 3RV28 circuit breakers according to UL 489. However, special infeed terminals, 3RV2925-5EB for sizes S00/S0 and 3RV2935-5E for size S2, must be used for this purpose, see page 7/52.

8US busbar adapters for 60 mm systems

The motor starter protectors/circuit breakers are mounted directly with the aid of busbar adapters on busbar systems with 60 mm center-to-center clearance in order to save space and to reduce infeed times and costs.

Busbar adapters for busbar systems with 60 mm center-to-center clearance are suitable for copper busbars with a width of 12 mm to 30 mm. The busbars can be 5 mm or 10 mm thick.

The motor starter protectors/circuit breakers are snapped onto the adapter and connected on the line side. This prepared unit is then plugged directly onto the busbar system, and is thus connected both mechanically and electrically at the same time.

For the setup of UL feeders (Type E and F), Type E terminal blocks or phase barriers must be fitted to the infeed module on the motor starter protector (see from page 7/57).

For further busbar adapters for snap-mounting direct-on-line starters and reversing starters as well as additional accessories such as line terminals and outgoing terminals, flat copper profile, etc., see Catalog LV 10.

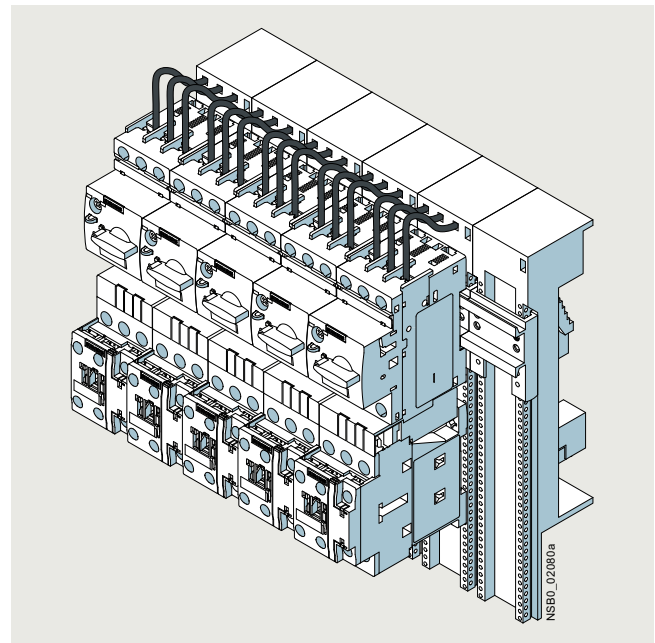

SIRIUS load feeders with busbar adapters snapped onto busbars





Protection equipment

Motor starter protectors/circuit breakers

SIRIUS 3RV2 motor starter protectors/circuit breakers

Accessories > Busbar accessories

Selection and ordering data

Modular spacing	Number of motor starter protectors that can be connected			Rated current I_n at 690 V	For motor starter protectors/circuit breakers	Article No.	Price per PU	PU (UNIT, SET, M)	PS*	PG		
	without lateral accessories	with lateral auxiliary switch	incl. auxiliary release									
mm				A	Size							
3-phase busbars												
For feeding several motor starter protectors with screw terminals, mounted side by side on DIN rails, insulated, with touch protection												
 3RV1915-1AB	45 ¹⁾²⁾	2	--	--	63	S00, S0 ³⁾	3RV1915-1AB		1	1 unit	41E	
		3	--	--	63	S00, S0 ³⁾						3RV1915-1BB
		4	--	--	63	S00, S0 ³⁾						3RV1915-1CB
		5	--	--	63	S00, S0 ³⁾						3RV1915-1DB
 3RV1915-1BB	55 ¹⁾⁴⁾	--	2	--	63	S00, S0 ³⁾	3RV1915-2AB		1	1 unit	41E	
		--	3	--	63	S00, S0 ³⁾						3RV1915-2BB
		--	4	--	63	S00, S0 ³⁾						3RV1915-2CB
		--	5	--	63	S00, S0 ³⁾						3RV1915-2DB
 3RV1915-1CB		2	--	--	108	S2	3RV1935-1A		1	1 unit	41E	
		3	--	--	108	S2						3RV1935-1B
		4	--	--	108	S2						3RV1935-1C
		--	--	--	--	--						--
 3RV1915-1DB	63 ¹⁾⁵⁾	--	--	2	63	S00, S0 ³⁾	3RV1915-3AB		1	1 unit	41E	
		--	--	4	63	S00, S0 ³⁾						3RV1915-3CB
		75 ⁵⁾	--	2	2	108	S2	3RV1935-3A		1	1 unit	41E
			--	3	3	108	S2					
		--	4	4	108	S2	3RV1935-3C		1	1 unit	41E	



- 1) Not suitable for 3RV21 motor starter protectors of sizes S00 and S0 without overload relay function.
 2) For 3RV2 motor starter protectors without accessories mounted on the side.
 3) Approved for motor starter protectors size S0 with $I_n \leq 32$ A.

- 4) For 3RV2 motor starter protectors with auxiliary switches with 1 NO + 1 NC, 2 NO and 2 NC mounted on the left (9 mm wide).
 5) For 3RV20, 3RV21, 3RV23 and 3RV24 motor starter protectors with mounted accessories (18 mm wide). Auxiliary switches with 2 NO + 2 NC or signaling switch (mounted on the left) or with auxiliary release (mounted on the right).

Version	Modular spacing	For motor starter protectors/circuit breakers	Article No.	Price per PU	PU (UNIT, SET, M)	PS*	PG
	mm	Size					
	45	S00, S0	3RV1915-5DB		1	1 unit	41E

Connecting pieces for 3-phase busbars

 3RV1915-5DB	For connecting 3-phase busbars for 3RV2 motor starter protectors of size S00/S0 (left) to the 3RV1011 motor starter protector (right)	45	S00, S0	3RV1915-5DB	1	1 unit	41E
--	---	----	---------	--------------------	---	--------	-----

Conductor cross-section			Tightening torque	For motor starter protectors/circuit breakers	Article No.	Price per PU	PU (UNIT, SET, M)	PS*	PG		
Solid or stranded	Finely stranded with end sleeve	AWG cables, solid or stranded									
mm ²	mm ²	AWG	Nm	Size							
3-phase infeed terminals											
Connection from top											
 3RV2925-5AB	2.5 ... 25	4 ... 16	10 ... 4	4	S00 ²⁾ , S0	3RV1915-5A		1	1 unit	41E	
	2.5 ... 25	2.5 ... 16	10 ... 4	3 ... 4	S00, S0						3RV2925-5AB
	2 x (2.5 ... 50) ¹⁾	2 x (2.5 ... 35) ¹⁾	2 x (10 ... 1/0) ¹⁾	4 ... 6	S2						3RV2935-5A
	1 x (2.5 ... 70) ¹⁾	1 x (2.5 ... 50) ¹⁾	1 x (10 ... 2/0) ¹⁾								
 3RV2935-5A	Connection from below										
	Terminal is connected in place of a switch, take space requirement into account										
 3RV2915-5B	2.5 ... 25	2.5 ... 16	10 ... 4	Input: 4, output: 2 ... 2.5	S00, S0	3RV2915-5B		1	1 unit	41E	

3-phase infeed terminals

- 1) If two different conductor cross-sections are connected to one clamping point, both cross-sections must be in the range specified.
 2) Especially suitable for 3RV1011 motor starter protectors. If the 3RV2 motor starter protector is used, the terminal block extends beyond the device width.

Protection equipment

Motor starter protectors/circuit breakers

SIRIUS 3RV2 motor starter protectors/circuit breakers

Accessories > Busbar accessories

Conductor cross-section			Tightening torque	For motor starter protectors/circuit breakers	Article No.	Price per PU	PU (UNIT, SET, M)	PS*	PG
Solid or stranded	Finely stranded with end sleeve	AWG cables, solid or stranded							
mm ²	mm ²	AWG	Nm	Size					

3-phase infeed terminals for constructing "starters (Type E)"



3RV2925-5EB

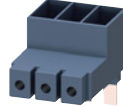

3RV2935-5E

Connection from top

2.5 ... 25	2.5 ... 16	10 ... 4	3 ... 4	S00, S0
2 x (2.5 ... 50) ¹⁾	2 x (2.5 ... 35) ¹⁾	2 x (10 ... 1/0) ¹⁾	4 ... 6	S2
1 x (2.5 ... 70) ¹⁾	1 x (2.5 ... 50) ¹⁾	1 x (10 ... 2/0) ¹⁾		

3RV2925-5EB	1	1 unit	41E
3RV2935-5E	1	1 unit	41E

¹⁾ If two different conductor cross-sections are connected to one clamping point, both cross-sections must be in the range specified.

Version	For motor starter protectors/circuit breakers	Article No.	Price per PU	PU (UNIT, SET, M)	PS*	PG
	Size					

Covers for connection tags



3RV1935-6A covers mounted on 3RV1915-1CB busbar

Touch protection for empty positions	S00, S0
	S2

3RV1915-6AB	1	10 units	41E
3RV1935-6A	1	5 units	41E

Protection equipment

Motor starter protectors/circuit breakers

SIRIUS 3RV2 motor starter protectors/circuit breakers

Accessories > Busbar accessories

Busbar adapters

8US1251-5DS10

8US1251-5DT11

8US1211-4TR00

8US1250-5AS10

8US1250-5AT10

For motor starter protectors/circuit breakers	Rated current	Connecting cable	Adapter length	Adapter width	Rated voltage	Article No.	Price per PU	PU (UNIT, SET, M)	PS*	PG
Size	A	AWG	mm	mm	V					
Busbar adapters for 60 mm systems										
For copper busbars according to DIN 46433 Width: 12 mm and 30 mm Thickness: 5 mm and 10 mm and for T and double-T special profiles										
• For motor starter protectors/circuit breakers with screw terminals ¹⁾						Screw terminals				
S00 ²⁾ , S0 ³⁾	25	12	200	45	690	8US1251-5DS10		1	1 unit	140
S00 ²⁾ , S0	25	12	260	45	690	8US1251-5DT10		1	1 unit	140
S0	32	10	200	45	690	8US1251-5NS10		1	1 unit	140
S0 ³⁾	32	10	260	45	690	8US1251-5NT10		1	1 unit	140
S2	80	4	200	55	690	8US1261-5MS13		1	1 unit	140
S2	80	4	260	55	690	8US1261-6MT10		1	1 unit	140
S2 ⁴⁾	80	4	260	118	690	8US1211-6MT10		1	1 unit	140
S3	100/70 ⁵⁾	4	215	72	690/600 ⁵⁾	8US1211-4TR00		1	1 unit	140
• For motor starter protectors/circuit breakers with spring-loaded terminals ⁶⁾						Spring-loaded terminals				
S00 ²⁾ , S0 ³⁾	25	12	200	45	690	8US1251-5DS11		1	1 unit	140
S00 ²⁾ , S0 ³⁾	25	12	260	45	690	8US1251-5DT11		1	1 unit	140
S0	32	10	200	45	690	8US1251-5NS11		1	1 unit	140
S0 ³⁾	32	10	260	45	690	8US1251-5NT11		1	1 unit	140

Accessories

Device holders	--	--	200	45	--	8US1250-5AS10		1	1 unit	140
For lateral attachment to busbar adapters	--	--	260	45	--	8US1250-5AT10		1	1 unit	140
Side modules	--	--	200	9	--	8US1998-2BJ10		1	10 units	140
For widening busbar adapters										
Vibration and shock kits										
For high vibration and shock loads										
S2	--	--	--	--	--	8US1998-1DA10		1	1 unit	140

¹⁾ For the setup of UL feeders (Type E and F), Type E terminal blocks or phase barriers (for sizes S00 to S2) must be fitted to the infeed module on the motor starter protector (see from page 7/57).

²⁾ Not for 3RV1011 motor starter protectors.

³⁾ Also approved for 3RV27, 3RV28 circuit breakers according to UL.

⁴⁾ For the assembly of feeders for reversing starters consisting of a motor starter protector and two contactors.

⁵⁾ Values according to UL/CSA:
 - Rated current: 70 A at 600 V AC
 - Short-circuit breaking capacity:
 480 V AC: 65 kA, up to $I_n = 30$ A,
 480 Y/277 V AC: 65 kA,
 600 Y/347 V AC: 20 kA.

⁶⁾ It is not possible to set up UL feeders (Type E and F).

For additional busbar adapters and accessories, see [Catalog LV 10](#).

Protection equipment

Motor starter protectors/circuit breakers

SIRIUS 3RV2 motor starter protectors/circuit breakers

Accessories > Rotary operating mechanisms

Overview

Door-coupling rotary operating mechanisms

Motor starter protectors/circuit breakers with a rotary operating mechanism can be mounted in a control cabinet and operated externally by means of a door-coupling rotary operating mechanism. When the cabinet door with motor starter protector/circuit breaker is closed, the operating mechanism is coupled. When the motor starter protector/circuit breaker closes, the coupling is locked which prevents the door from being opened unintentionally. This interlock can be defeated by the maintenance personnel. In the OFF position, the rotary operating mechanism can be secured against reclosing with up to three padlocks. Inadvertent opening of the door is not possible in this case either.

With the optional 3RV2926-.Q tolerance compensation, an offset can be compensated when installing the door-coupling rotary operating mechanism. For this purpose, the standard coupling head on the shaft is removed and replaced by the tolerance compensation.



Video: SIRIUS door-coupling rotary mechanism

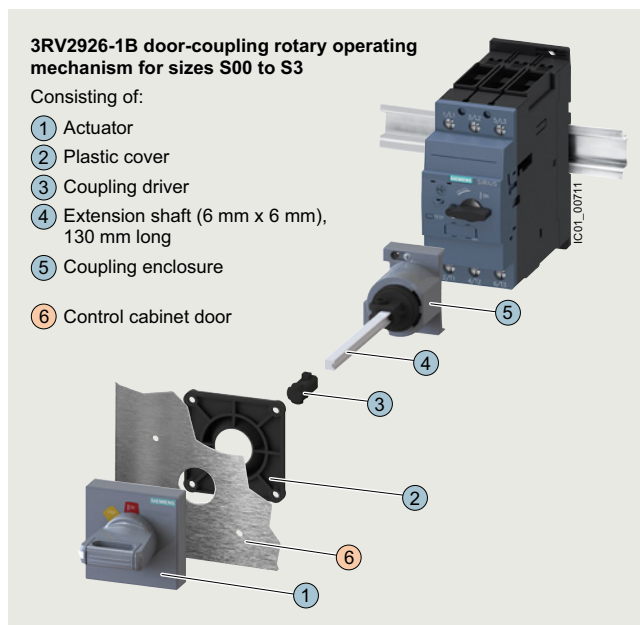

SIRIUS 3RV2926-1B door-coupling rotary operating mechanism

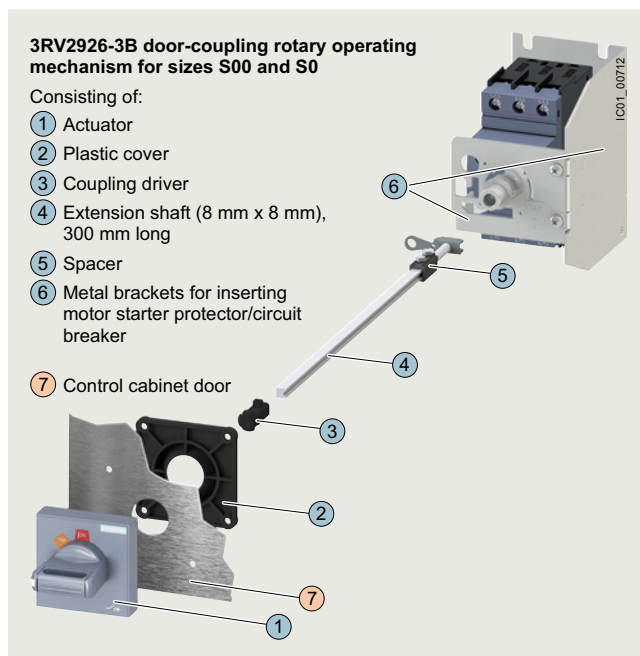

SIRIUS 3RV2926-3B door-coupling rotary operating mechanism for harsh conditions

Protection equipment

Motor starter protectors/circuit breakers

SIRIUS 3RV2 motor starter protectors/circuit breakers

Accessories > Rotary operating mechanisms

Door-coupling rotary operating mechanism for mounting one main switch in size S3 according to UL 508A and NFPA 79

For the installation of a door-coupling rotary operating mechanism for harsh conditions for a main switch (only possible in size S3) in a UL control cabinet (according to UL 508A and NFPA 79), the standard stipulates a second handle in the control cabinet. With the cabinet door open, it shall only be possible to switch on this supplementary handle by means of a "deliberate action".

The figure below shows the setup required for this purpose, with the 3RV2946-3C door-coupling rotary operating mechanism for harsh conditions, the 3RV2926-0P shaft support, and the 3VA9137-0GC05 supplementary handle (EMERGENCY OFF version).

To switch on the supplementary handle, the handle must be pressed against a spring in the direction of the mounting plane. This is the required "deliberate action" so that the supplementary handle does not turn empty and the circuit breaker can be closed.

3RV2946-3C EMERGENCY OFF door-coupling rotary operating mechanism for size S3

Consisting of:

- ① Actuator
- ② Plastic cover
- ③ Coupling driver
- ④ Extension shaft (8 mm x 8 mm), 300 mm long
- ⑤ Spacer
- ⑥ Metal brackets for inserting motor starter protector/circuit breaker

- ⑦ Control cabinet door

Required for assembly of main control switch in accordance with UL 508A and NFPA 79

(can be optionally ordered):

- ⑧ 3RV2926-0P shaft support
- ⑨ 3VA9137-0GC05 supplementary handle (EMERGENCY OFF version)

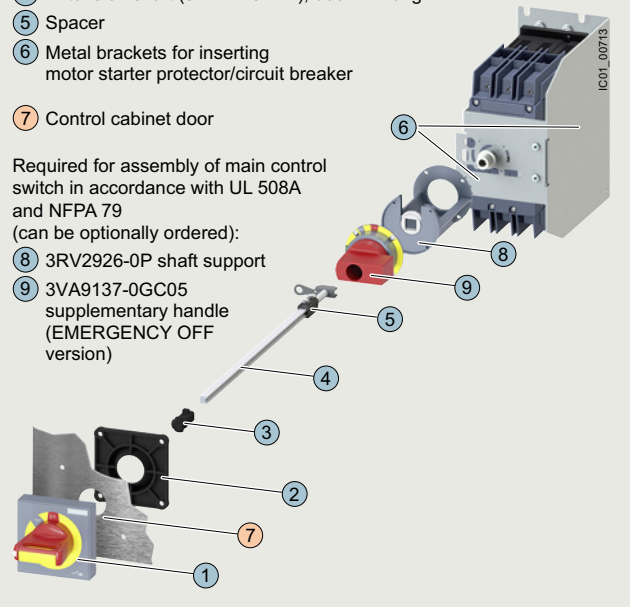

SIRIUS 3RV2946-3C EMERGENCY OFF door-coupling rotary operating mechanism for harsh operating conditions according to UL 508A and NFPA 79 with optional shaft support and supplementary handle (EMERGENCY OFF version)

Selection and ordering data

Version	Color of actuator	Version of extension shaft mm	For motor starter protectors/ circuit breakers Size	Article No.	Price per PU	PU (UNIT, SET, M)	PS*	PG
---------	-------------------	----------------------------------	---	-------------	--------------	-------------------	-----	----

Door-coupling rotary operating mechanisms



3RV2926-1B



3RV2926-1C



3RV2926-0Q

The door-coupling rotary operating mechanisms consist of an actuator, a coupling driver and a 130/330 mm long extension shaft (6 mm x 6 mm).

The door-coupling rotary operating mechanisms are dimensioned for degree of protection IP64. For UL/CSA applications, they are tested for enclosure types 1, 3R and 12. The door interlocking prevents accidental opening of the control cabinet door in the ON position of the motor starter protector. The OFF position can be locked with up to three padlocks.

With the optional 3RV2926-0Q tolerance compensation, an offset can be compensated when installing the door-coupling rotary operating mechanism.

Door-coupling rotary operating mechanisms	Gray	130	S00 ¹⁾ ... S3	3RV2926-1B		1	1 unit	41E
		330	S00 ¹⁾ ... S3	3RV2926-1K		1	1 unit	41E

EMERGENCY OFF door-coupling rotary operating mechanisms	Red/ yellow	130	S00 ¹⁾ ... S3	3RV2926-1C		1	1 unit	41E
		330	S00 ¹⁾ ... S3	3RV2926-1L		1	1 unit	41E

Optional accessories

Tolerance compensation	--	--	--	3RV2926-0Q		1	1 unit	41E
-------------------------------	----	----	----	-------------------	--	---	--------	-----

¹⁾ Not for 3RV1011 motor starter protectors.

Protection equipment

Motor starter protectors/circuit breakers

SIRIUS 3RV2 motor starter protectors/circuit breakers

Accessories > Rotary operating mechanisms

Version	Color of actuator	Version of extension shaft mm	For motor starter protectors/ circuit breakers Size	Article No.	Price per PU	PU (UNIT, SET, M)	PS*	PG
---------	-------------------	----------------------------------	---	-------------	--------------	-------------------	-----	----

Door-coupling rotary operating mechanisms for harsh conditions



3RV2946-3B



3RV2946-3C

The door-coupling rotary operating mechanisms consist of an actuator, a coupling driver, an extension shaft of 300 mm in length (8 mm x 8 mm), a spacer and two metal brackets, into which the motor starter protector/circuit breaker is inserted.

The door-coupling rotary operating mechanisms are designed to degree of protection IP65. For UL/CSA applications, they are tested for enclosure types 1, 3R and 12. The door interlocking reliably prevents opening of the control cabinet door in the ON position of the motor starter protector/circuit breaker. The OFF position can be locked with up to three padlocks.

Laterally mountable auxiliary releases and 2-pole auxiliary switches can be used.

The door-coupling rotary operating mechanisms thus meet the requirements for isolating functions according to IEC 60947-2.

With the optional 3RV2926-2Q tolerance compensation, an offset can be compensated when installing the door-coupling rotary operating mechanism for harsh conditions.

Door-coupling rotary operating mechanisms	Gray	300	S00 ¹⁾ , S0 S2 S3	3RV2926-3B 3RV2936-3B 3RV2946-3B		1	1 unit	41E
EMERGENCY OFF door-coupling rotary operating mechanism	Red/ yellow	300	S00 ¹⁾ , S0 S2 S3	3RV2926-3C 3RV2936-3C 3RV2946-3C		1	1 unit	41E

Optional accessories

Tolerance compensation	--	--	S00 ... S3	3RV2926-2Q		1	1 unit	41E
-------------------------------	----	----	------------	-------------------	--	---	--------	-----

Necessary accessories for mounting one main switch in size S3 according to UL 508A and NFPA 79 (see also page 7/55)

Shaft supports	--	--	S00 ... S3	3RV2926-0P		1	1 unit	41E
-----------------------	----	----	------------	-------------------	--	---	--------	-----

Supplementary handles

• Standard	Gray	--	S3	3VA9137-0GC01		1	1 unit	12P
• EMERGENCY OFF	Red/ yellow	--	S3	3VA9137-0GC05		1	1 unit	12P



3RV2926-2Q



3RV2926-0P



3VA9137-0GC01

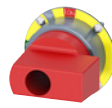

3VA9137-0GC05

¹⁾ Not for 3RV1011 motor starter protectors.

Overview

More information

System Manual for modular system, see <https://support.industry.siemens.com/cs/ww/en/view/60311318>

Equipment Manual, see <https://support.industry.siemens.com/cs/ww/en/view/60279172>

Accessories for "Self-Protected Combination Motor Controllers (Type E)" according to UL 508/UL 60947-4-1

The 3RV20 motor starter protectors with screw terminals are approved according to UL 508/UL 60947-4-1 as "Self-Protected Combination Motor Controllers (Type E)".

The 3RV1011 motor starter protectors do not have this UL approval.

This requires increased clearance and creepage distances (1 inch and 2 inches respectively) at the input side of the device, which are achieved by mounting a terminal block or a phase barrier. No transverse auxiliary switches may be used when using 3RT2946-4GA07 terminal blocks for size S3.

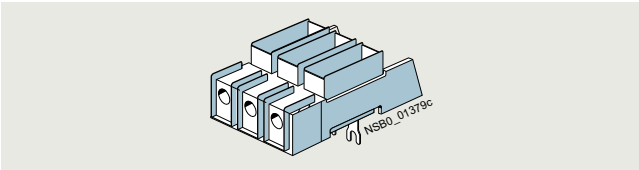

SIRIUS 3RV2928-1H terminal block

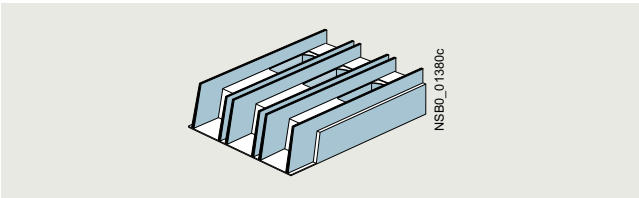

SIRIUS 3RT2946-4GA07 terminal block (Type E)

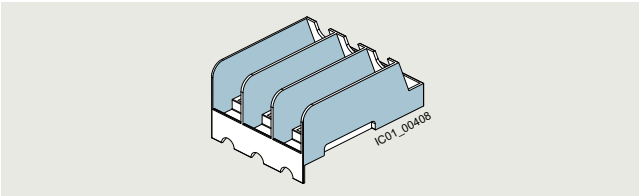

SIRIUS 3RV2928-1K phase barrier

Motor starter protectors/circuit breakers	Size	Essential accessories for "Self-Protected Combination Motor Controllers (Type E)" according to UL 508/UL 60947-4-1
3RV201., 3RV202.	S00/S0	3RV2928-1H terminal block or 3RV2928-1K phase barrier
3RV2031-4B.1., 3RV2031-4D.1., 3RV2031-4E.1., 3RV2031-4P.1., 3RV2031-4S.1., 3RV2031-4T.1., 3RV2031-4U.1., 3RV2031-4V.1.	S2	--
3RV2031-4J.1., 3RV2031-4K.1., 3RV2031-4R.1., 3RV2031-4W.1., 3RV2031-4X.1., 3RV2032	S2	3RV2938-1K phase barrier
3RV204.	S3	3RT2946-4GA07 terminal block

-- No accessories needed

Special 3-phase infeed terminals are required for constructing "Starters (Type E)" with an insulated 3-phase busbar system (see "Busbar accessories", page 7/52).

For the setup of "Starters (Type E)" with 8US busbar adapters, Type E terminal blocks or phase barriers (for sizes S00 to S2) must be fitted to the infeed module on the motor starter protector/circuit breaker, see page 7/60.

The 3RV29 infeed system also enables the assembly of "Starters (Type E)", see page 7/67 onwards.

Note:

According to CSA, these terminal blocks and the phase barriers can be omitted when the device is used as a "Self-Protected Combination Motor Controller (Type E)".

Protection equipment

Motor starter protectors/circuit breakers

SIRIUS 3RV2 motor starter protectors/circuit breakers

Accessories > Mounting accessories

Link modules

Feeders can be easily assembled from single devices with the help of the link modules. The following table shows the different combination options for devices with screw or spring-loaded terminals.

Combination devices	3RV2 motor starter protectors/circuit breakers Size	3RT2 contactors; 3RW30, 3RW40 soft starters; 3RF34 solid-state contactors Size	Link modules	
			Screw terminals	Spring-loaded terminals
Link modules for connecting switching devices to 3RV2 motor starter protectors/circuit breakers¹⁾				
3RT2 contactors with AC or DC coil	S00	S00	3RA1921-1DA00	3RA2911-2AA00
	S0	S00		--
	S2	S2	3RA2931-1AA00	--
	S3 ²⁾	S3 ²⁾	3RA1941-1AA00	--
3RT2 contactors with AC coil	S00	S0	3RA2921-1AA00	--
	S0	S0		3RA2921-2AA00 ³⁾
3RT2 contactors with DC or AC/DC coil	S00	S0	3RA2921-1BA00	--
	S0	S0		3RA2921-2AA00
3RW30 soft starters	S00	S00	3RA2921-1BA00	3RA2911-2GA00
	S0	S00		--
3RW30/3RW40 soft starters	S00	S0	3RA2921-1BA00	--
	S0	S0		3RA2921-2GA00
	S2 ⁴⁾	S2 ⁴⁾	3RA2931-1AA00	--
	S3 ⁵⁾	S3 ⁵⁾	3RA1941-1AA00	--
3RF34 solid-state contactors	S00/S0	S00	3RA2921-1BA00	--
Hybrid link modules for connecting contactors with spring-loaded terminals to 3RV2 motor starter protectors/circuit breakers with screw terminals⁶⁾				
3RT2 contactors with AC or DC coil	S00	S00	3RA2911-2FA00	--
	S0	S0	3RA2921-2FA00	--

-- Version not possible

- 1) The link modules cannot be used for 3RV2.21-4PA1., 3RV2.21-4FA1., 3RV2.31-4K.1., 3RV2.31-4R.1., 3RV2.32-4K.1., 3RV2.32-4R.1., 3RV27, 3RV28 and 3RV1011 motor starter protectors/circuit breakers.
- 2) To assemble the feeder between a motor starter protector and a contactor in size S3, the 3RA2942-1AA00 DIN-rail adapter must be used.
- 3) A spacer for height compensation on AC contactors, size S0, is optionally available, see page 7/61.
- 4) To assemble the feeder between a motor starter protector and a soft starter in size S2, the 3RA2932-1CA00 DIN-rail adapter must be used.
- 5) It is only permissible to assemble the feeder between the motor starter protector and the soft starter in size S3 on a mounting plate.
- 6) The hybrid link modules for motor starter protector to contactor cannot be used for 3RV2.21-4PA1., 3RV2.21-4FA1., 3RV27 and 3RV28 motor starter protectors/circuit breakers. They are suitable only for constructing direct-on-line starters.

Notes:

- Link modules can be used in
 - Size S00: up to max. 16 A
 - Size S0: up to max. 32 A
 - Size S2: up to max. 65 A
- Hybrid link modules can be used in
 - Size S00: up to max. 16 A
 - Size S0: up to max. 32 A

Protection equipment







Motor starter protectors/circuit breakers

SIRIUS 3RV2 motor starter protectors/circuit breakers

Accessories > Mounting accessories

Selection and ordering data

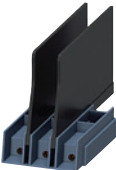
Accessories

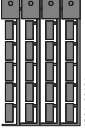
Version	For motor starter protectors/ circuit breakers	Article No.	Price per PU	PU (UNIT, SET, M)	PS*	PG
Covers						
	Terminal covers For cable lug and busbar connection for maintaining the required voltage clearances and as touch protection if box terminal is removed (two units can be mounted per motor starter protector/circuit breaker)	S3		1	1 unit	41B
3RV2 (size S3) with 3RT1946-4EA1 (below)		3RT1946-4EA1				
	Scale covers Sealable, for covering the set current scale	3RV20, 3RV21, 3RV24: S00 ... S3		100	10 units	41E
3RV2908-0P		3RV2908-0P				
	Covers for devices with screw terminals (box terminals) Additional touch protection to be fitted at the box terminals (two units required per device)					
3RT2936-4EA2	Main current level	S2		1	1 unit	41B
		S3		1	1 unit	41B
Terminal covers for box terminals on 3RV2742 and Type E terminal block 3RT2946-4GA07						
	Additional touch protection to be fitted at the 3RV2742 box terminals (two units required per device) and at 3RT2946-4GA07 terminal block (Type E)					
3RV2948-1LA00	Main current level	S3		1	1 unit	41E
Phase barrier for constructing limiter combinations of size S3¹⁾						
	Infeed to the limiter is always on the side 2T1/4T2/6T3. Use 3RV2948-1K phase barriers on the infeed side.					
3RV2948-1K	Main current level	S3		1	1 unit	41E
Fixing accessories						
	Push-in lugs For screw fixing of the motor starter protector/ circuit breaker onto mounting plates Two units are required for each motor starter protector.	S00, S0		100	10 units	41E
3RV2928-0B						
Tools for opening spring-loaded terminals						
	Screwdrivers For all SIRIUS devices with spring-loaded terminals Length approx. 200 mm, 3.0 mm x 0.5 mm, S00 ... S3 titanium gray/black, partially insulated					
3RA2908-1A				1	1 unit	41B
Blank labels						
	Unit labeling plates¹⁾ For SIRIUS devices, 20 mm x 7 mm, titanium gray	S00 ... S3		100	340 units	41B
3RT2900-1SB20	Adhesive labels For SIRIUS devices, 19 mm x 6 mm, titanium gray	S00 ... S3		100	3 060 units	41B

¹⁾ PC labeling system for individual inscription of unit labeling plates available from: murrplastik Systemtechnik GmbH (see page 16/18).

Protection equipment

Motor starter protectors/circuit breakers

SIRIUS 3RV2 motor starter protectors/circuit breakers

Accessories > Mounting accessories

Version	For motor starter protectors/ circuit breakers Size	Article No.	Price per PU	PU (UNIT, SET, M)	PS*	PG
---------	---	-------------	-----------------	-------------------------	-----	----

Terminal blocks and phase barriers for "Self-Protected Combination Motor Controllers (Type E)" according to UL 508/UL 60947-4-1



3RV2928-1H

Note:

UL 508/UL 60947-4-1 approval demands 1-inch clearance and 2-inch creepage distances for "Self-Protected Combination Motor Controllers (Type E)". The following terminal blocks or phase barriers must be used for the 3RV20 motor starter protectors with screw terminals. This also applies to construction with the 8US busbar adapter. 3RV20 motor starter protectors with spring-loaded terminals must be assembled with the 3RV29 infeed system for approval as "Self-Protected Combination Motor Controllers (Type E)" according to UL 508/UL 60947-4-1. The 3RV1011 motor starter protectors do not have UL approval as "Starters (Type E)".

The terminal block or phase barriers cannot be used in combination with the 3RV19.5 3-phase busbars.

For construction with 3-phase busbars, see "Busbar Accessories", from page 7/50 onwards.



3RT2946-4GA07

Terminal blocks Type E

For increased clearance and creepage distances (1 and 2 inch)

S00¹⁾, S0S3²⁾**3RV2928-1H**

1

1 unit

41E

3RT2946-4GA07

1

1 unit

41B

Phase barriers

For increased clearance and creepage distances (1 and 2 inch)

S00¹⁾, S0

S2

3RV2928-1K

1

1 unit

41E

3RV2938-1K

1

1 unit

41E

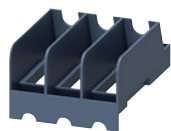

3RV2928-1K

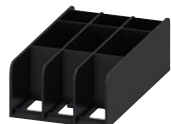

3RV2938-1K

Auxiliary conductor terminals, 3-pole



3RT2946-4F

For connection of auxiliary and control cables to the main conductor connections (for one side)

S3

3RT2946-4F

1

1 unit

41B

¹⁾ Not for 3RV1011 motor starter protectors.

²⁾ Cannot be used on 3RV2.4. motor starter protectors in combination with transverse auxiliary switches.







Protection equipment

Motor starter protectors/circuit breakers

SIRIUS 3RV2 motor starter protectors/circuit breakers

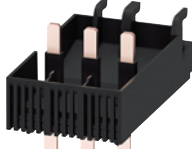
Accessories > Mounting accessories

Link modules

For 3RV2 motor starter protectors/circuit breakers	For 3RT2 contactors	Actuating voltage of contactor	Article No.	Price per PU	PU (UNIT, SET, M)	PS*	PG
Size	Size						
Link modules for motor starter protector to contactor¹⁾							
For connection between motor starter protector and contactor with screw terminals			Screw terminals 				
Single-unit packaging							
	S00/S0	S00	AC, DC	3RA1921-1DA00	1	1 unit	41B
	S00/S0	S0	AC	3RA2921-1AA00	1	1 unit	41B
	S00/S0	S0	DC, AC/DC	3RA2921-1BA00	1	1 unit	41B
3RA2921-1AA00	S2	S2	AC, DC, AC/DC	3RA2931-1AA00	1	1 unit	41B
	S3	S3	AC, DC, AC/DC	3RA1941-1AA00	1	1 unit	41B
Multi-unit packaging							
	S00/S0	S00	AC, DC	3RA1921-1D	1	10 units	41B
	S00/S0	S0	AC	3RA2921-1A	1	10 units	41B
	S00/S0	S0	DC, AC/DC	3RA2921-1B	1	10 units	41B
3RA2931-1AA00	S2	S2	AC, DC, AC/DC	3RA2931-1A	1	5 units	41B
	S3	S3	AC, DC, AC/DC	3RA1941-1A	1	5 units	41B
							
3RA1941-1AA00							
For connection between motor starter protector and contactor with spring-loaded terminals			Spring-loaded terminals 				
Single-unit packaging							
	S00	S00	AC, DC	3RA2911-2AA00	1	1 unit	41B
	S0	S0	AC ²⁾ , DC, AC/DC	3RA2921-2AA00	1	1 unit	41B
3RA2911-2AA00							
Multi-unit packaging							
	S00	S00	AC, DC	3RA2911-2A	1	10 units	41B
	S0	S0	AC ²⁾ , DC, AC/DC	3RA2921-2A	1	10 units	41B
Spacers²⁾							
For height compensation on AC contactors size S0 with spring-loaded terminals							
	S0	S0	Single-unit packaging	3RA2911-1CA00	1	1 unit	41B
	S0	S0	Multi-unit packaging	3RA2911-1C	1	5 units	41B
3RA2911-1CA00							

¹⁾ The link modules for motor starter protector to contactor cannot be used for 3RV1011, 3RV2.21-4PA1., 3RV2.21-4FA1., 3RV2.31-4K.1., 3RV2.31-4R.1., 3RV2.32-4K.1., 3RV2.32-4R.1., 3RV27 and 3RV28 motor starter protectors/circuit breakers.

²⁾ A spacer for height compensation on AC contactors size S0 is optionally available.

Note:

Link modules can be used in







- Size S00: up to max. 16 A
- Size S0: up to max. 32 A
- Size S2: up to max. 65 A

Protection equipment

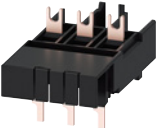
Motor starter protectors/circuit breakers

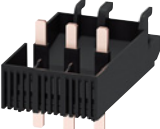
SIRIUS 3RV2 motor starter protectors/circuit breakers

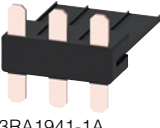
Accessories > Mounting accessories

For 3RV2 motor starter protectors/circuit breakers Size	For 3RW30, 3RW40 soft starters; 3RF34 solid-state contactors Size	Article No.	Price per PU	PU (UNIT, SET, M)	PS*	PG	
Link modules for motor starter protector to soft starter¹⁾ and motor starter protector to solid-state contactor¹⁾							
 <p>3RA2921-1BA00</p>		Connection between motor starter protector and soft starter/solid-state contactor with screw terminals Single-unit packaging S00/S0 S00/S0 S2 ²⁾ S2 ²⁾ S3 ³⁾ S3 ³⁾ Multi-unit packaging S00/S0 S00/S0 S2 ²⁾ S2 ²⁾ S3 ³⁾ S3 ³⁾		Screw terminals 			
 <p>3RA2931-1AA00</p>		Connection between motor starter protector and soft starter with spring-loaded terminals Single-unit packaging S00 S00 S0 S0		Spring-loaded terminals 			
 <p>3RA1941-1A</p>							
 <p>3RA2911-2GA00</p>							
				3RA2921-1BA00 1 1 unit 41B 3RA2931-1AA00 1 1 unit 41B 3RA1941-1AA00 1 1 unit 41B 3RA2921-1B 1 10 units 41B 3RA2931-1A 1 5 units 41B 3RA1941-1A 1 5 units 41B			
				3RA2911-2GA00 1 1 unit 41B 3RA2921-2GA00 1 1 unit 41B			

- ¹⁾ The link modules from motor starter protector to soft starter and motor starter protector to solid-state contactor cannot be used for the 3RV1011, 3RV2.21-4PA1., 3RV2.21-4FA1., 3RV2.31-4K.1., 3RV2.31-4R.1., 3RV2.32-4K.1., 3RV2.32-4R.1., 3RV27 and 3RV28 motor starter protectors/circuit breakers.
- ²⁾ To assemble the feeder between a motor starter protector and a soft starter in size S2, the 3RA2932-1CA00 DIN-rail adapter must be used.
- ³⁾ It is only permissible to assemble the feeder between the motor starter protector and the soft starter in size S3 on a mounting plate.

Note:

Link modules can be used in



- Size S00: up to max. 16 A
- Size S0: up to max. 32 A
- Size S2: up to max. 65 A

Protection equipment

Motor starter protectors/circuit breakers

SIRIUS 3RV2 motor starter protectors/circuit breakers

Accessories > Mounting accessories



For 3RV2 motor starter protectors/circuit breakers	For 3RT2 contactors	Actuating voltage of contactor	Article No.	Price per PU	PU (UNIT, SET, M)	PS*	PG
Size	Size						
Hybrid link modules for motor starter protector to contactor¹⁾							
	Mechanical and electrical connection between motor starter protector with screw terminals and contactor with spring-loaded terminals						
3RA2911-2FA00	Single-unit packaging						
	S00	S00	AC, DC	3RA2911-2FA00	1	1 unit	41B
	S0	S0	AC ²⁾ , DC, AC/DC	3RA2921-2FA00	1	1 unit	41B
	Multi-unit packaging						
3RA2921-2FA00	S00	S00	AC, DC	3RA2911-2F	1	10 units	41B
	S0	S0	AC ²⁾ , DC, AC/DC	3RA2921-2F	1	10 units	41B
	Spacers²⁾						
3RA2911-1CA00	For height compensation on AC contactors size S0 with spring-loaded terminals						
	S0	S0	Single-unit packaging	3RA2911-1CA00	1	1 unit	41B
	S0	S0	Multi-unit packaging	3RA2911-1C	1	5 units	41B

¹⁾ The hybrid link modules for motor starter protector to contactor cannot be used for 3RV1011, 3RV2.21-4PA1., 3RV2.21-4FA1., 3RV27 and 3RV28 motor starter protectors/circuit breakers. They are suitable only for constructing direct-on-line starters.

²⁾ A spacer for height compensation on AC contactors size S0 is optionally available.

Note:
Link modules can be used in

- Size S00: up to max. 16 A
- Size S0: up to max. 32 A

For motor starter protectors/circuit breakers	Version	Screw terminals	PU (UNIT, SET, M)	PS*	PG
Type		Article No.	Price per PU		
Connection module (adapter and plug) for motor starter protectors/circuit breakers with screw terminals					
	The connection module comprises an adapter and a motor feeder connector.				
	3RV2.2	Adapter Ambient temperature $t_{u \text{ max.}} = 60 \text{ °C}$ Size S0, rated operational current I_e at AC-3/AC-3e/400 V: 25 A	3RT1926-4RD01	1	1 unit 41B
	3RV2.2	Motor feeder connector Size S0	3RT1900-4RE01	1	1 unit 41B

Protection equipment

Motor starter protectors/circuit breakers

SIRIUS 3RV2 motor starter protectors/circuit breakers

Accessories > Enclosures and front plates

Overview

Enclosures

For the stand-alone installation of 3RV20 to 3RV24 motor starter protectors size S00 ($I_{n\max} = 16\text{ A}$), S0 ($I_{n\max} = 32\text{ A}$), S2 ($I_{n\max} = 65\text{ A}$), and for 3RV1011 motor starter protectors, molded-plastic and cast aluminum enclosures for surface mounting and molded-plastic enclosures for flush mounting are available in various dimensions.

When installed in a molded-plastic enclosure, the motor starter protectors have a rated operational voltage U_e of 500 V.

The enclosures for surface mounting have the degree of protection IP55; the enclosures for flush mounting also comply with the degree of protection IP55 at the front. The cast aluminum enclosures for surface mounting achieve degree of protection IP65.

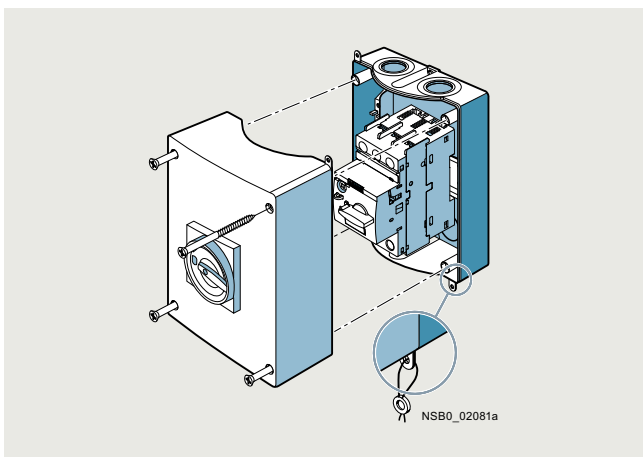

Enclosures for surface mounting

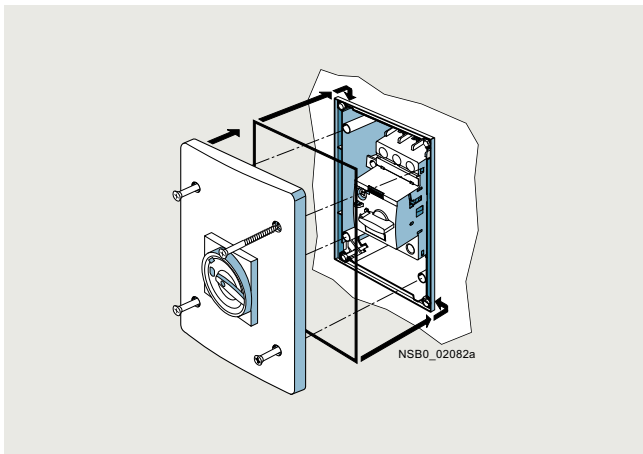

Enclosures for flush mounting (only for sizes S00 and S0)

There are two knock-out cable entries for cable glands at the top and two at the bottom; also on the rear corresponding cable entries are scored. There is a knockout on the top of the enclosure for indicator lights that are available as accessories.

The narrow enclosure can accommodate a motor starter protector without accessories, with transverse auxiliary switch and with lateral auxiliary switch. There is no provision for installing a motor starter protector with a signaling switch.

With size S00 to S2 3RV2 circuit breakers, the molded-plastic enclosures are equipped with a rotary operating mechanism.

The enclosures can be supplied with either a black rotary operating mechanism or with an EMERGENCY OFF rotary operating mechanism with a red/yellow knob.

In the OFF position, all rotary operating mechanisms can be locked with up to three padlocks. These enclosures are not suitable for 3RV1011 motor starter protectors.

Front plates

Motor starter protectors are frequently required to be actuated in any enclosure. Front plates equipped with a rotary operating mechanism for 3RV20 to 3RV24 motor starter protectors sizes S00 to S3 are available for this purpose.

A holder for the motor starter protectors sizes S00 and S0, into which the motor starter protectors can be snapped, is available for the front plates. It is not possible to use a signaling switch or 4-pole auxiliary switch. The front plates are not suitable for 3RV1011 motor starter protectors.

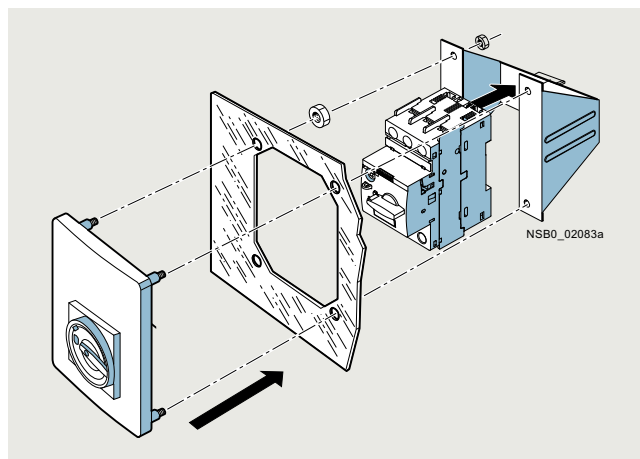

Front plate (including holder) for sizes S00 and S0







Protection equipment

Motor starter protectors/circuit breakers

SIRIUS 3RV2 motor starter protectors/circuit breakers

Accessories > Enclosures and front plates

Selection and ordering data

Version	Degree of protection	Integrated terminals	Width mm	For 3RV20 to 3RV24 motor starter protectors Size	Article No.	Price per PU	PU (UNIT, SET, M)	PS*	PG
Molded-plastic enclosures for surface mounting¹⁾									
 3RV1933-1DA00	With rotary operating mechanism, lockable in 0 position	IP55	N and PE	54 (for motor starter protector + lateral auxiliary switch)	S00 ³⁾ , S0	3RV1923-1CA00	1	1 unit	41E
				72 (for motor starter protector + lateral auxiliary switch ²⁾ + auxiliary release)	S00 ³⁾ , S0	3RV1923-1DA00	1	1 unit	41E
				82 (for motor starter protector + lateral auxiliary switch ²⁾ + auxiliary release)	S2	3RV1933-1DA00	1	1 unit	41E
 3RV1923-1FA00, 3RV1933-1GA00	With EMERGENCY OFF rotary operating mechanism, lockable in 0 position	IP55	N and PE	54 (for motor starter protector + lateral auxiliary switch)	S00 ³⁾ , S0	3RV1923-1FA00	1	1 unit	41E
				72 (for motor starter protector + lateral auxiliary switch ²⁾ + auxiliary release)	S00 ³⁾ , S0	3RV1923-1GA00	1	1 unit	41E
				82 (for motor starter protector + lateral auxiliary switch ²⁾ + auxiliary release)	S2	3RV1933-1GA00	1	1 unit	41E
Cast aluminum enclosures for surface mounting¹⁾									
 3RV1923-1DA01	With rotary operating mechanism, lockable in 0 position	IP65	PE ⁴⁾	72 (for motor starter protector + lateral auxiliary switch ²⁾ + auxiliary release)	S00 ³⁾ , S0	3RV1923-1DA01	1	1 unit	41E
				72 (for motor starter protector + lateral auxiliary switch ²⁾ + auxiliary release)	S00 ³⁾ , S0	3RV1923-1GA01	1	1 unit	41E
Molded-plastic enclosures for flush mounting⁵⁾									
 3RV1923-2DA00	With rotary operating mechanism, lockable in 0 position	IP55 (front side)	N and PE	72 (for motor starter protector + lateral auxiliary switch ²⁾ + auxiliary release)	S00 ³⁾ , S0	3RV1923-2DA00	1	1 unit	41E
				72 (for motor starter protector + lateral auxiliary switch ²⁾ + auxiliary release)	S00 ³⁾ , S0	3RV1923-2GA00	1	1 unit	41E
 3RV1913-2DA00	With actuator diaphragm	IP55 (front side)	N and PE	72 (for motor starter protector + lateral auxiliary switch ²⁾ + auxiliary release)	S00 ⁶⁾	3RV1913-2DA00	1	1 unit	41E
Molded-plastic enclosures for surface mounting									
 3RV1913-1CA00	With actuator diaphragm	IP55	N and PE	85	S00 ⁶⁾	3RV1913-1CA00	1	1 unit	41E
				105	S00 ⁶⁾	3RV1913-1DA00	1	1 unit	41E

¹⁾ The rear cable bushings cannot be used on 3RV2.11-...2. and 3RV2.21-...2. devices with spring-loaded terminals.

²⁾ Only valid for lateral auxiliary switches with two auxiliary contacts.

³⁾ Not for 3RV1011 motor starter protectors.

⁴⁾ If required, an additional N terminal can be mounted (e.g. 8WA1011-1BG11).

⁵⁾ Not suitable for 3RV2.11-...2. and 3RV2.21-...2. devices with spring-loaded terminals.

⁶⁾ Only for 3RV1011 motor starter protectors.

Protection equipment

Motor starter protectors/circuit breakers

SIRIUS 3RV2 motor starter protectors/circuit breakers

Accessories > Enclosures and front plates

Version	Degree of protection	For 3RV20 to 3RV24 motor starter protectors Size	Article No.	Price per PU	PU (UNIT, SET, M)	PS*	PG
Front plates¹⁾							
 <p>3RV1923-4B + 3RV1923-4G</p>	Molded-plastic front plates with rotary operating mechanism, lockable in 0 position For actuation of 3RV2 motor starter protectors in any enclosure		IP55 (front side)	S00 ²⁾ up to S3	3RV1923-4B	1	1 unit 41E
	Molded-plastic front plates with EMERGENCY OFF rotary operating mechanism, red/yellow, lockable in 0 position EMERGENCY OFF actuation of 3RV2 motor starter protectors in any enclosure		IP55 (front side)	S00 ²⁾ up to S3	3RV1923-4E	1	1 unit 41E
	Holders for front plates Holder is mounted on front plate, motor starter protector with and without accessories is snapped in.		--	S00 ²⁾ , S0	3RV1923-4G	1	1 unit 41E

¹⁾ It is not possible to use a signaling switch or 4-pole auxiliary switch with front plates.

²⁾ Not for 3RV1011 motor starter protectors.

Version	Rated control supply voltage U_s	For 3RV20 to 3RV24 motor starter protectors Size	Article No.	Price per PU	PU (UNIT, SET, M)	PS*	PG
Indicator lights							
 <p>3RV1903-5B</p>	Indicator lights For all enclosures and front plates		110 ... 120	S00 to S3	3RV1903-5B	1	1 unit 41E
			220 ... 240		3RV1903-5C	1	1 unit 41E
	<ul style="list-style-type: none"> With LED lamp for versions 110 ... 120 V, with glow lamp for versions 220 ... 500 V 		380 ... 415		3RV1903-5E	1	1 unit 41E
			480 ... 500		3RV1903-5G	1	1 unit 41E
	<ul style="list-style-type: none"> With colored lenses red, green, yellow-orange and clear 						

Protection equipment

Motor starter protectors/circuit breakers

SIRIUS 3RV2 motor starter protectors/circuit breakers

3RV29 infeed system

Overview

The 3RV29 infeed system is a convenient means of energy supply and distribution for a group of several motor starter protectors or complete load feeders with screw or spring-loaded terminals in sizes S00 and S0. Motor starter protectors or load feeders with a rated current of maximum 32 A each can be used. 3RV21 motor starter protectors cannot be used in this system.

The system is based on a basic module complete with a lateral incoming unit (3-phase busbar with infeed). This infeed with spring-loaded terminals is mounted on the right or left, depending on the version, and can be supplied with a maximum conductor cross-section of 25 mm² (with end sleeve). A basic module has two sockets onto each of which a motor starter protector can be snapped.

Expansion modules (3-phase busbars for system expansion) are available for extending the system. The individual modules are connected through an expansion plug.

The electrical connection between the 3-phase busbars and the motor starter protectors is implemented through plug-in connectors. The complete system can be mounted on a TH 35 DIN rail to IEC 60715, and can be expanded as required up to a maximum current carrying capacity of 63 A.

The system is mounted extremely quickly and easily thanks to the simple plug-in terminals. Thanks to the lateral infeed, the system also saves space in the control cabinet.

The additional height required for the infeed unit is only 30 mm. The alternative infeed possibilities on each side offer a high

degree of flexibility for configuring the control cabinet: Infeed on left-hand or right-hand side as well as infeed on one side and outfeed on the other side to supply further loads are all possible. A terminal block with spring-loaded terminals in combination with a DIN rail enables the integration of not only SIRIUS motor starter protectors but also 1-phase, 2-phase and 3-phase components such as 5SY miniature circuit breakers or SIRIUS relay components.

The 3RV29 infeed system is approved in accordance with IEC 99 to 500 V. It is also UL-approved and authorized for "Self-Protected Combination Motor Controllers" starters (Type E), for starters (Type F) (starters (Type E) + contactors) and for circuit breakers according to UL 489 (3RV27/3RV28).

Assembly kits for constructing the infeed system with spring-loaded terminals

The following versions can be ordered:

- Basic set for two feeders
- Expansion sets for two or three feeders

The assembly kits contain 3-phase busbars, plug-in connectors and contactor bases (see page 7/72).

Note:

Each set contains plug-in connectors for sizes S00 and S0.

Example: The basic set contains four plug-in connectors (two each for S00 and S0).

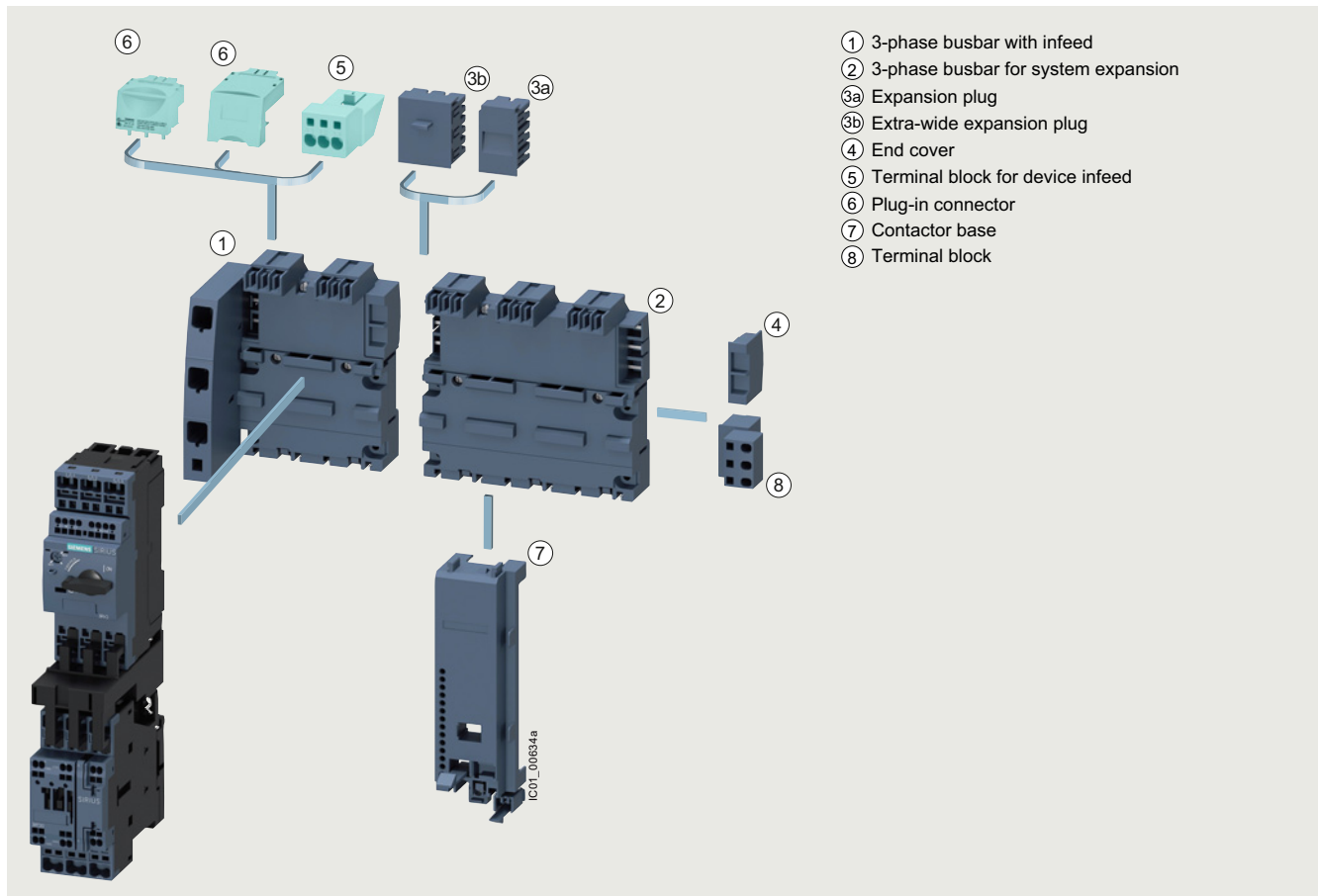

SIRIUS 3RV29 infeed system

Protection equipment

Motor starter protectors/circuit breakers

SIRIUS 3RV2 motor starter protectors/circuit breakers

3RV29 infeed system

① 3-phase busbars with infeed

A 3-phase busbar with infeed unit is required for connecting the incoming supply. These modules comprise one infeed module and two sockets which each accept one motor starter protector. A choice of two versions with infeed on the left or right is available. The infeed is connected to spring-loaded terminals. They permit an infeed with conductor cross-sections of up to 25 mm² with end sleeve. An end cover is supplied with each module.

② 3-phase busbars for system expansion

The 3-phase busbars for system expansion support expansion of the system. There is a choice of modules with two or three sockets. The system can be expanded as required up to a maximum current carrying capacity of 63 A. An expansion plug is supplied with each module.

③a Expansion plug

The expansion plug is used for electrical connection of adjacent 3-phase busbars. The current carrying capacity of this plug equals 63 A. One expansion plug is supplied with each 3-phase busbar for system expansion. Additional expansion plugs are therefore only required as spare parts.

③b Extra-wide expansion plug

The wide expansion plug makes the electrical connection between two 3-phase busbars, thus performing the same function as the 3RV2917-5BA00 expansion plug; the electrical characteristics (e.g. a current carrying capacity of 63 A) are identical.

The 3RV2917-5E expansion plug is 10 mm wider than the 3RV2917-5BA00 expansion plug, hence in the plugged state there is a distance of 10 mm between the connected 3-phase busbars. This distance can be used to lay the auxiliary current and control current wiring ("wiring duct"). The motor starter protector and contactor can be wired from underneath, which means that the complete cable duct above the system can be omitted.

④ End cover

The end cover is used to cover the 3-phase busbar at the open end of the system. This cover is therefore only required once for each system. An end cover is supplied with each 3-phase busbar system with infeed. Further end covers are therefore only required as spare parts.

⑤ Terminal block for device infeed

A new addition to the system is a plug for outfeeding to a device slot within a module. This offers the option not only of connecting three-phase loads to the system, but also of integrating 1-phase loads into the infeed system.

⑥ Plug-in connector

The plug-in connector is used for the electrical connection between the 3-phase busbar and the 3RV2 or 3RV1011 motor starter protector. These plug-in connectors are available for screw or spring-loaded terminals.

⑦ Contactor base

Load feeders can be assembled in the system using the S00 and S0 contactor base. The contactor bases are suitable for contactors of sizes S00 and S0 with screw and spring-loaded terminals and are simply snapped onto the 3-phase busbars. Direct-on-line starters and reversing starters are possible. One contactor base is required for direct-on-line starters and two are required for reversing starters.

To assemble load feeders for reversing starters, the contactor bases can be arranged alongside each other (90 mm overall width). In this case the mechanical interlocking of the contactors is possible. The S0 contactor bases are also suitable for soft starters size S00 and S0 with screw terminal.

The infeed system is designed for mounting on a TH 35 DIN rail with 7.5 mm overall depth. This DIN rail gives the contactor base a stable mounting surface to sit on. If DIN rails with a depth of 15 mm are used, the spacer connected to the bottom of the contactor base must be knocked out and plugged into the DIN rail mating piece, which is also located on the underside. Then the contactor base also has a stable mounting surface. When DIN rails with a depth of 7.5 mm are used, the spacer has no function and can be removed.

The link modules are used for direct on-line starters, in which case the use of a contactor base is not absolutely necessary. Motor starter protector and contactor assemblies can then be directly snapped onto the sockets of the 3-phase busbars. For feeders of sizes S00 and S0, the corresponding 3RA1921-1...., 3RA2911-2...., 3RA2921-1.... or 3RA2921-2.... link modules should generally be used.

⑧ Terminal block

The 3RV2917-5D terminal block enables the integration of not only SIRIUS motor starter protectors but also 1-phase, 2-phase and 3-phase components. The three phases can be fed out of the system using the terminal block; which means that single-phase loads can also be integrated in the system. The terminal block is plugged into the slot of the expansion plug and thus enables outfeeding from the middle or end of the infeed system. The terminal block can be rotated through 180° and be locked to the support modules of the infeed system. In addition, the 45 mm wide TH 35 3RV1917-7B DIN rail option for screwing onto the support plate facilitates plugging the 1-phase, 2-phase and 3-phase components onto the infeed system.



Video:
[SIRIUS News SIRIUS 3RV29 infeed system - Assembly without tools](#)

Protection equipment

Motor starter protectors/circuit breakers

SIRIUS 3RV2 motor starter protectors/circuit breakers

3RV29 infeed system

Technical specifications

More information

Equipment Manual, see
<https://support.industry.siemens.com/cs/ww/en/view/60279172>

General data

Type	3RV29.7			
Size	S00, S0			
Standards	<ul style="list-style-type: none"> • IEC 60947-2 Yes • IEC 60947-4-1 Yes • UL 508/UL 60947-4-1 Yes 			
Rated current I_n	A	63		
Permissible rated current at inside temperature of control cabinet				
Motor starter protectors	Size	Rated current	Inside temperature of control cabinet	
• 3RV2.11/3RV1011	S00	... 14 A	60 °C	% 100
		> 14 ... 16 A	40 °C	% 100
			60 °C	% 87
• 3RV2.21	S0	... 16 A	60 °C	% 100
		> 16 ... 25 A	40 °C	% 100
			60 °C	% 87
		> 25 ... 32 A	40 °C	% 87
Permissible ambient temperature				
• Storage/transport	°C	-50 ... +80		
• Operation	°C	-20 ... +60		
Rated operational voltage U_e				
• According to IEC	10% overvoltage	V AC	500	
	5% overvoltage	V AC	525	
• According to UL/CSA		V AC	600	
Rated frequency		Hz	50/60	
Rated impulse withstand voltage U_{imp}		kV	6	
Short-circuit strength	corresponds to the mounted motor starter protector or load feeder. The assembly instructions must be followed, see Operating Instructions			
Degree of protection IP on the front according to IEC 60529	IP20 with cover and 25 mm ² conductor cross-section at the infeed terminal			
Touch protection on the front according to IEC 60529	Finger-safe for vertical touching from the front with cover and 25 mm ² conductor cross-section at the infeed terminal			

Conductor cross-sections

Type		3-phase busbar with infeed 3RV2917-1A, 3RV2917-1E	Terminal block 3RV2917-5D	Terminal block for device infeed 3RV2917-5FA00
Conductor cross-sections (min./max.)				
• Solid or stranded	mm ²	4 ... 25	1.5 ... 6	1 ... 10
• Finely stranded with end sleeve	mm ²	4 ... 25	1.5 ... 4	1 ... 6
• Finely stranded without end sleeve	mm ²	6 ... 25	1.5 ... 6	--
• AWG cables	AWG	10 ... 3	15 ... 10	18 ... 8

Protection equipment

Motor starter protectors/circuit breakers

SIRIUS 3RV2 motor starter protectors/circuit breakers

3RV29 infeed system

Selection and ordering data

Type	Version	For 3RV20, 3RV23, 3RV24, 3RV27, 3RV28, 3RV1011 motor starter protectors Size	Article No.	Price per PU	PU (UNIT, SET, M)	PS*	PG
------	---------	---	-------------	-----------------	-------------------------	-----	----

3-phase busbars with infeed

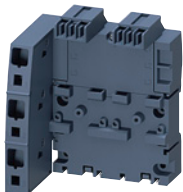

3RV2917-1A

3-phase busbars with infeed

Incl. 3RV2917-6A end cover

For two motor starter protectors with screw or spring-loaded terminals

- With infeed on the left S00, S0
- With infeed on the right S00, S0

3RV2917-1A
3RV2917-1E

1 1 unit 41E
1 1 unit 41E

3-phase busbars for system expansion



3RV2917-4A

3-phase busbars

Incl. 3RV2917-5BA00 expansion plug

For motor starter protectors with screw or spring-loaded terminals

- For 2 motor starter protectors S00, S0
- For 3 motor starter protectors S00, S0

3RV2917-4A
3RV2917-4B

1 1 unit 41E
1 1 unit 41E

Plug-in connectors



3RV2917-5AA00

Plug-in connectors

To make contact with the 3RV2 motor starter protectors

- For spring-loaded terminals
 - Single-unit packaging S00¹⁾
S0²⁾
 - Multi-unit packaging S00¹⁾
S0²⁾

Spring-loaded terminals



3RV2917-5AA00
3RV2927-5AA00
3RV2917-5A
3RV2927-5A

1 1 unit 41E
1 1 unit 41E
1 10 units 41E
1 10 units 41E

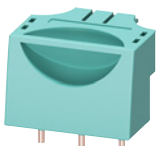

3RV2917-5CA00

- For screw terminals

Screw terminals



3RV2917-5CA00
3RV1927-5AA00
3RV2917-5C
3RV1927-5A

1 1 unit 41E
1 1 unit 41E
1 10 units 41E
1 10 units 41E

Plug-in connectors

To make contact with the 3RV1011 motor starter protectors

- For screw terminals
 - Single-unit packaging S00
 - Multi-unit packaging S00

3RV1917-5CA00
3RV1917-5C

1 1 unit 41E
1 10 units 41E

¹⁾ $I > 14$ A, please note derating.

²⁾ $I > 16$ A, please note derating.

³⁾ The plug-in connector cannot be used for the 3RV2711 and 3RV2811 circuit breakers with size S00.

⁴⁾ The plug-in connector can be used for the 3RV2711, 3RV2811 (size S00) and 3RV2721, 3RV2821 (size S0) circuit breakers.

Type	Version	For contactors Size	Article No.	Price per PU	PU (UNIT, SET, M)	PS*	PG
------	---------	------------------------	-------------	-----------------	-------------------------	-----	----

Contactors bases



3RV2927-7AA00

Contactors bases

Single-unit packaging S00¹⁾
S00¹⁾, S0

For mounting direct-on-line or reversing starters

3RV2917-7AA00
3RV2927-7AA00

1 1 unit 41E
1 1 unit 41E

¹⁾ Not for 3RV1011 motor starter protectors.

Protection equipment

Motor starter protectors/circuit breakers

SIRIUS 3RV2 motor starter protectors/circuit breakers

3RV29 infeed system

Type	Version	Article No.	Price per PU	PU (UNIT, SET, M)	PS*	PG
Terminal blocks						
	Terminal blocks For integration of 1-phase, 2-phase and 3-phase components	Single-unit packaging	3RV2917-5D	1	1 unit	41E
TH 35 DIN rails, width 45 mm						
	TH 35 DIN rails According to IEC 60715, width 45 mm For mounting on 3-phase busbars	Single-unit packaging	3RV1917-7B	1	1 unit	41E
Extra-wide expansion plugs						
	Extra-wide expansion plugs As accessory	Single-unit packaging	3RV2917-5E	1	1 unit	41E
Expansion plugs						
	Expansion plugs¹⁾ As spare part	Single-unit packaging	3RV2917-5BA00	1	1 unit	41E
End covers						
	End covers²⁾ As spare part	Multi-unit packaging	3RV2917-6A	100	10 units	41E
Terminal blocks for device infeed						
	Terminal blocks for device infeed	Single-unit packaging	3RV2917-5FA00	1	1 unit	41E

¹⁾ The expansion plug is included in the scope of supply of the 3RV2917-4, 3-phase busbars for system expansion.

²⁾ The end cover is included in the scope of supply of the 3RV2917-1, 3-phase busbars with infeed system.

Protection equipment

Motor starter protectors/circuit breakers

SIRIUS 3RV2 motor starter protectors/circuit breakers

3RV29 infeed system

Version	For motor starter protectors/circuit breakers with spring-loaded terminals	Spring-loaded terminals 	PU (UNIT, SET, M)	PS*	PG
Size		Article No.	Price per PU		

Assembly kits for constructing the infeed system with spring-loaded terminals¹⁾

Basic set for two feeders		3RV2907-1AB00	1	1 unit	41E
contains:					
• 1 x 3-phase busbars 3RV2917-1A (incl. end cover 3RV2917-6A), with infeed left, for two motor starter protectors with spring-loaded terminals	S00, S0				
• 2 x plug-in connectors for spring-loaded terminals 3RV2917-5AA00	S00				
• 2 x plug-in connectors for spring-loaded terminals 3RV2927-5AA00	S0				
• 2 x 3RV2927-7AA00 contactor bases	S00, S0				
Expansion set for two feeders		3RV2907-4AB00	1	1 unit	41E
contains:					
• 1 x 3-phase busbars 3RV2917-4A (incl. expansion plug 3RV2917-5BA00), for two motor starter protectors with spring-loaded terminals	S00, S0				
• 2 x plug-in connectors for spring-loaded terminals 3RV2917-5AA00	S00				
• 2 x plug-in connectors for spring-loaded terminals 3RV2927-5AA00	S0				
• 2 x 3RV2927-7AA00 contactor bases	S00, S0				
Expansion set for three feeders		3RV2907-4BB00	1	1 unit	41E
contains:					
• 1 x 3-phase busbars 3RV2917-4B (incl. expansion plug 3RV2917-5BA00), for three motor starter protectors with spring-loaded terminals	S00, S0				
• 3 x plug-in connectors for spring-loaded terminals 3RV2917-5AA00	S00				
• 3 x plug-in connectors for spring-loaded terminals 3RV2927-5AA00	S0				
• 3 x 3RV2927-7AA00 contactor bases	S00, S0				

¹⁾ Not for 3RV1011 motor starter protectors.

Protection equipment

Motor starter protectors/circuit breakers

SIRIUS 3RV1 motor starter protectors/circuit breakers

AC-3e

IE3/IE4 ready

For fuse monitoring

Technical specifications

See pages 7/9, 7/11, 7/14, 7/19, 7/20 and 7/23

Selection and ordering data

Without auxiliary switches

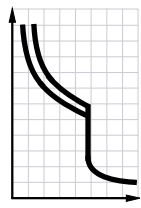

Rated current	Thermal overload release	Instantaneous electronic release	Short-circuit breaking capacity at 400 V AC	Screw terminals	PU (UNIT, SET, M)	PS*	PG
I_n		$I >$	I_{cu}	Article No.	Price per PU		
A	A	A	kA				
Size S00							
0.2	0.2	1.2	100	3RV1611-0BD10	1	1 unit	41E



3RV1611-0BD10

Note:

The auxiliary switch required for signaling must be ordered separately.

Accessories

Version	Contacts	Screw terminals	PU (UNIT, SET, M)	PS*	PG
		Article No.	Price per PU		

Mountable auxiliary switches (essential accessories)



3RV2901-1E

Transverse auxiliary switches With screw terminals, mountable on the front	1 NO + 1 NC	3RV2901-1E	1	1 unit	41E
--	-------------	-------------------	---	--------	-----



3RV2901-1A

Lateral auxiliary switches With screw terminals, mountable on the left	1 NO + 1 NC	3RV2901-1A	1	1 unit	41E
--	-------------	-------------------	---	--------	-----

Additional auxiliary switches and other accessories, see from page 7/47 onwards.

Protection equipment

Motor starter protectors/circuit breakers

SIRIUS 3RV1 motor starter protectors/circuit breakers

For distance protection

Technical specifications

See page 7/24

Selection and ordering data

Voltage transformer motor starter protectors with transverse auxiliary switches (1 CO)

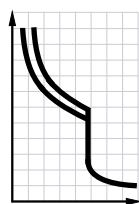

Rated current	Thermal overload release	Instantaneous electronic release	Auxiliary switch integrated in the motor starter protector, transverse	Short-circuit breaking capacity at 400 V AC	Screw terminals	PU (UNIT, SET, M)	PS*	PG
I_n				I_{cu}	Article No.	Price per PU		
A	A	A		kA				

Size S00



3RV1611-1.G14

1.4	1.4	6	1 CO	50	3RV1611-1AG14	1	1 unit	41E
2.5	2.5	10.5	1 CO	50	3RV1611-1CG14	1	1 unit	41E
3	3	20	1 CO	50	3RV1611-1DG14	1	1 unit	41E

Accessories

Version	Contacts	Screw terminals	PU (UNIT, SET, M)	PS*	PG
		Article No.	Price per PU		

Mountable auxiliary switches for other signaling purposes



3RV2901-1A

Lateral auxiliary switches With screw terminals, mountable on the left	1 NO + 1 NC	3RV2901-1A	1	1 unit	41E
--	-------------	-------------------	---	--------	-----

Additional auxiliary switches and other accessories, see from page 7/47 onwards.

Protection equipment

Motor starter protectors/circuit breakers

SIRIUS 3RV1 motor starter protectors/circuit breakers

AC-3e



IE3/IE4 ready

For motor protection

Selection and ordering data

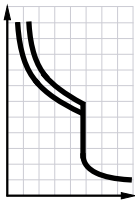
CLASS 10, without auxiliary switches



Rated current	Suitable for three-phase motors ¹⁾ with P	Setting range for thermal overload release	Instantaneous electronic release	Short-circuit breaking capacity at 400 V AC	Screw terminals 	PU (UNIT, SET, M)	PS*	PG
I_n			$I >$	I_{cu}	Article No.	Price per PU		
A	kW	A	A	kA				
Size S00								
0.16	0.04	0.11 ... 0.16	2.1	100	3RV1011-0AA10		1	1 unit 41E
0.2	0.06	0.14 ... 0.2	2.6	100	3RV1011-0BA10		1	1 unit 41E
0.25	0.06	0.18 ... 0.25	3.3	100	3RV1011-0CA10		1	1 unit 41E
0.32	0.09	0.22 ... 0.32	4.2	100	3RV1011-0DA10		1	1 unit 41E
0.4	0.09	0.28 ... 0.4	5.2	100	3RV1011-0EA10		1	1 unit 41E
0.5	0.12	0.35 ... 0.5	6.5	100	3RV1011-0FA10		1	1 unit 41E
0.63	0.18	0.45 ... 0.63	8.2	100	3RV1011-0GA10		1	1 unit 41E
0.8	0.18	0.55 ... 0.8	10	100	3RV1011-0HA10		1	1 unit 41E
1	0.25	0.7 ... 1	13	100	3RV1011-0JA10		1	1 unit 41E
1.25	0.37	0.9 ... 1.25	16	100	3RV1011-0KA10		1	1 unit 41E
1.6	0.55	1.1 ... 1.6	21	100	3RV1011-1AA10		1	1 unit 41E
2	0.75	1.4 ... 2	26	100	3RV1011-1BA10		1	1 unit 41E
2.5	0.75	1.8 ... 2.5	33	100	3RV1011-1CA10		1	1 unit 41E
3.2	1.1	2.2 ... 3.2	42	100	3RV1011-1DA10		1	1 unit 41E
4	1.5	2.8 ... 4	52	100	3RV1011-1EA10		1	1 unit 41E
5	1.5	3.5 ... 5	65	100	3RV1011-1FA10		1	1 unit 41E
6.3	2.2	4.5 ... 6.3	82	100	3RV1011-1GA10		1	1 unit 41E
8	3	5.5 ... 8	104	50	3RV1011-1HA10		1	1 unit 41E
10	4	7 ... 10	130	50	3RV1011-1JA10		1	1 unit 41E
12	5.5	9 ... 12	156	50	3RV1011-1KA10		1	1 unit 41E





3RV1011-...A10

¹⁾ Guide value for 4-pole standard motors at 50 Hz 400 V AC. The actual starting and rated data of the motor to be protected must be considered when selecting the units.

The accessories of 3RV2 motor starter protectors/circuit breakers can be used with exceptions, see page 7/47 onwards.

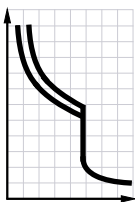
CLASS 10, with transverse auxiliary switch (1 NO + 1 NC)



Rated current	Suitable for three-phase motors ¹⁾ with P	Setting range for thermal overload release	Instantaneous electronic release	Short-circuit breaking capacity at 400 V AC	Screw terminals 	PU (UNIT, SET, M)	PS*	PG
I_n			$I >$	I_{cu}	Article No.	Price per PU		
A	kW	A	A	kA				
Size S00								
0.16	0.04	0.11 ... 0.16	2.1	100	3RV1011-0AA15		1	1 unit 41E
0.2	0.06	0.14 ... 0.2	2.6	100	3RV1011-0BA15		1	1 unit 41E
0.25	0.06	0.18 ... 0.25	3.3	100	3RV1011-0CA15		1	1 unit 41E
0.32	0.09	0.22 ... 0.32	4.2	100	3RV1011-0DA15		1	1 unit 41E
0.4	0.09	0.28 ... 0.4	5.2	100	3RV1011-0EA15		1	1 unit 41E
0.5	0.12	0.35 ... 0.5	6.5	100	3RV1011-0FA15		1	1 unit 41E
0.63	0.18	0.45 ... 0.63	8.2	100	3RV1011-0GA15		1	1 unit 41E
0.8	0.18	0.55 ... 0.8	10	100	3RV1011-0HA15		1	1 unit 41E
1	0.25	0.7 ... 1	13	100	3RV1011-0JA15		1	1 unit 41E
1.25	0.37	0.9 ... 1.25	16	100	3RV1011-0KA15		1	1 unit 41E
1.6	0.55	1.1 ... 1.6	21	100	3RV1011-1AA15		1	1 unit 41E
2	0.75	1.4 ... 2	26	100	3RV1011-1BA15		1	1 unit 41E
2.5	0.75	1.8 ... 2.5	33	100	3RV1011-1CA15		1	1 unit 41E
3.2	1.1	2.2 ... 3.2	42	100	3RV1011-1DA15		1	1 unit 41E
4	1.5	2.8 ... 4	52	100	3RV1011-1EA15		1	1 unit 41E
5	1.5	3.5 ... 5	65	100	3RV1011-1FA15		1	1 unit 41E
6.3	2.2	4.5 ... 6.3	82	100	3RV1011-1GA15		1	1 unit 41E
8	3	5.5 ... 8	104	50	3RV1011-1HA15		1	1 unit 41E
10	4	7 ... 10	130	50	3RV1011-1JA15		1	1 unit 41E
12	5.5	9 ... 12	156	50	3RV1011-1KA15		1	1 unit 41E



3RV1011-...A15 with integrated transverse auxiliary switch

¹⁾ Guide value for 4-pole standard motors at 50 Hz 400 V AC. The actual starting and rated data of the motor to be protected must be considered when selecting the units.

The accessories of 3RV2 motor starter protectors/circuit breakers can be used with exceptions, see page 7/47 onwards.

Protection equipment

Overload relays

General data

Overview

More information

Homepage, see www.siemens.com/sirius-control

Industry Mall, see

- www.siemens.com/product?3RU2
- www.siemens.com/product?3RB3
- www.siemens.com/product?3RB2

TIA Selection Tool Cloud (TST Cloud), see

www.siemens.com/tstcloud/?node=ElectronicOverloadRelay

Configuration Manual for load feeders, see

<https://support.industry.siemens.com/cs/ww/en/view/39714188>

Conversion tool, see www.siemens.com/conversion-tool



Features

3RU21

3RB30/3RB31

3RB20/3RB21

3RB22/3RB23

3RB24

Benefits

General data

Sizes

S00 ... S3

S00 ... S3

S6 ... S12

S00 ... S12

S00 ... S12

- Are coordinated with the dimensions, connections and technical characteristics of the other devices in the SIRIUS modular system (contactors, etc.)
- Permit the mounting of slim and compact load feeders in widths of 45 mm (S00, S0), 55 mm (S2), 70 mm (S3), 120 mm (S6) and 145 mm (S10/S12); this does not include the current measuring modules for the 3RB22 to 3RB24 evaluation modules sizes S00 to S3
- Simplify configuration

Seamless current range

0.11 ... 100 A

0.1 ... 115 A

50 ... 630 A

0.3 ... 630 A
(up to 820 A)¹⁾

0.3 ... 630 A
(up to 820 A)¹⁾

- Allows easy and consistent configuration with one series of overload relays (for small to large loads)

Protection functions

Tripping due to overload

✓

✓

✓

✓

✓

- Provides optimum inverse-time delayed protection of loads against excessive temperature rises due to overload

Tripping due to phase asymmetry

✓

✓

✓

✓

✓

- Provides optimum inverse-time delayed protection of loads against excessive temperature rises due to phase asymmetry

Tripping due to phase failure

✓

✓

✓

✓

✓

- Minimizes heating of three-phase motors during phase failure

Protection of single-phase loads

✓

--

--

✓

✓

- Enables the protection of single-phase loads

Tripping in the event of overheating

--²⁾

--²⁾

--²⁾

✓

✓

- Provides optimum temperature-dependent protection of loads against excessive temperature rises, e.g. for stator-critical motors or in the event of insufficient coolant flow, contamination of the motor surface or long starting or braking operations

by

Integrated thermistor motor protection function

--

✓

✓

✓

✓

- Eliminates the need for additional special equipment
- Saves space in the control cabinet
- Reduces wiring outlay and costs

Tripping in the event of a ground fault

--

✓
(only 3RB31)

✓
(only 3RB21)

✓

✓

- Provides optimum protection of loads against incomplete ground faults due to moisture, condensed water, damage to the insulation material, etc.

by

Internal ground-fault detection (activatable)

--

✓

✓

✓

✓

- Eliminates the need for additional special equipment
- Saves space in the control cabinet
- Reduces wiring outlay and costs

✓ Available

-- Not available

¹⁾ Motor currents up to 820 A can be recorded and evaluated, e.g. by a 3RB2906-2BG1 current measuring module (0.3 to 3 A), in combination with a 3UF1868-3GA00 (820 A/1 A) series transformer. For 3UF18 transformers, see page 10/21.

²⁾ The SIRIUS 3RN thermistor motor protection devices can be used to provide additional temperature-dependent protection.



Features	3RU21	3RB30/3RB31	3RB20/3RB21	3RB22/3RB23	3RB24	Benefits
Features						
RESET function	✓	✓	✓	✓	✓	<ul style="list-style-type: none"> Allows manual or automatic resetting of the device
Remote RESET function	✓ (by means of separate module)	✓ (only with 3RB31 and external auxiliary voltage 24 V DC)	✓ (only with 3RB21 and external auxiliary voltage 24 V DC)	✓ (electrically via external button)	✓ (electrically with button or via IO-Link)	<ul style="list-style-type: none"> Allows the remote resetting of the device
TEST function for auxiliary contacts	✓	✓	✓	✓	✓	<ul style="list-style-type: none"> Allows easy checking of the function and wiring
TEST function for electronics	--	✓	✓	✓	✓	<ul style="list-style-type: none"> Allows checking of the electronics
Status display	✓	✓	✓	✓	✓	<ul style="list-style-type: none"> Displays the current operating state
Large current adjustment button	✓	✓	✓	✓	✓	<ul style="list-style-type: none"> Makes it easier to set the relay exactly to the correct current value
Integrated auxiliary contacts (1 NO + 1 NC)	✓	✓	✓	✓ (2 x)	--	<ul style="list-style-type: none"> Allow the load to be switched off if necessary Can be used to output signals
Integrated auxiliary contacts (1 CO and 1 NO in series)	--	--	--	--	✓	<ul style="list-style-type: none"> Enable the controlling of contactors directly from the higher-level control system through IO-Link
IO-Link connection	--	--	--	--	✓	<ul style="list-style-type: none"> Reduction of wiring in the control cabinet Enables communication
Connection of optional handheld device	--	--	--	--	✓	<ul style="list-style-type: none"> Enables local operation
Communication capability through IO-Link						
Full starter functionality through IO-Link	--	--	--	--	✓	<ul style="list-style-type: none"> Enables in combination with the SIRIUS 3RT contactors the assembly of communication-capable motor starters (direct-on-line, reversing and star-delta (wye-delta) starting)
Readout of diagnostics functions	--	--	--	--	✓	<ul style="list-style-type: none"> Enables the readout of diagnostics information such as overload, open circuit, ground fault, etc.
Readout of current values	--	--	--	--	✓	<ul style="list-style-type: none"> Enables the readout of current values and their direct processing in the higher-level control system
Readout of all set parameters	--	--	--	--	✓	<ul style="list-style-type: none"> Enables the readout of all set parameters, e.g. for plant documentation

✓ Available

-- Not available

Protection equipment

Overload relays

General data



Features	3RU21	3RB30/3RB31	3RB20/3RB21	3RB22/3RB23	3RB24	Benefits
Design of load feeders						
Short-circuit strength up to 100 kA at 690 V (in conjunction with the corresponding fuses or the corresponding motor starter protector)	✓	✓	✓	✓	✓	<ul style="list-style-type: none"> Provides optimum protection of the loads and operating personnel in the event of short circuits due to insulation faults or faulty switching operations
Electrical and mechanical matching to 3RT contactors	✓	✓	✓	✓ ¹⁾	✓ ¹⁾	<ul style="list-style-type: none"> Simplifies configuration Reduces wiring outlay and costs Enables stand-alone installation as well as space-saving direct mounting
Straight-through transformers for main circuit²⁾ (in this case the cables are routed through the feed-through openings of the overload relay and connected directly to the box terminals of the contactor)	--	✓ (S2, S3)	✓ (S6)	✓ (S00 ... S6)	✓ (S00 ... S6)	<ul style="list-style-type: none"> Reduce the contact resistance (only one point of contact) Save wiring costs (easy, no need for tools, and fast) Save material costs Reduce installation costs
Spring-loaded terminals for main circuit²⁾	✓ (S00, S0)	✓ (S00, S0)	--	--	--	<ul style="list-style-type: none"> Enable fast connections Permit vibration-resistant connections Enable maintenance-free connections
Spring-loaded terminals for auxiliary circuits²⁾	✓	✓	✓	✓	✓	<ul style="list-style-type: none"> Enable fast connections Permit vibration-resistant connections Enable maintenance-free connections
Full starter functionality through IO-Link	--	--	--	--	✓	<ul style="list-style-type: none"> Enables in combination with the SIRIUS 3RT contactors the assembly of communication-capable motor starters (direct-on-line, reversing and star-delta (wye-delta) starting)
Starter function	--	--	--	--	✓	<ul style="list-style-type: none"> Integration of feeders via IO-Link in the control system up to 630 A or 820 A

✓ Available
-- Not available

¹⁾ Exception: up to size S3, only stand-alone installation is possible.

²⁾ Available as an alternative to screw terminals.



Features	3RU21	3RB30/3RB31	3RB20/3RB21	3RB22/3RB23	3RB24	Benefits
Other features						
Temperature compensation	✓	✓	✓	✓	✓	<ul style="list-style-type: none"> Allows the use of the relays at high temperatures without derating Prevents premature tripping Allows compact installation of the control cabinet without distance between the devices/load feeders Simplifies configuration Enables space to be saved in the control cabinet
Very high long-term stability	✓	✓	✓	✓	✓	<ul style="list-style-type: none"> Provides safe protection for the loads even after years of use in harsh operating conditions
Wide setting ranges	--	✓ (1:4)	✓ (1:4)	✓ (1:10)	✓ (1:10)	<ul style="list-style-type: none"> Minimize the configuring outlay and costs Minimize storage overhead, storage costs, and tied-up capital
Fixed trip class	CLASS 10, CLASS 10A	3RB30: CLASS 10E or CLASS 20E	3RB20: CLASS 10E or CLASS 20E	--	--	<ul style="list-style-type: none"> Optimum motor protection for standard starts
CLASS 5E, 10E, 20E, 30E trip classes adjustable on the device	--	✓ (only 3RB31)	✓ (only 3RB21)	✓	✓	<ul style="list-style-type: none"> Enable solutions for very fast starting motors requiring special protection (e.g. Ex motors) Enable heavy starting solutions Reduce the number of variants Minimize the configuring outlay and costs Minimize storage overhead, storage costs, and tied-up capital
Low power loss	--	✓	✓	✓	✓	<ul style="list-style-type: none"> Reduces power consumption and energy costs (up to 98% less power is used than for thermal overload relays) Minimizes temperature rises of the contactor and control cabinet – in some cases this may eliminate the need for control cabinet cooling Direct mounting to contactor saves space, even for high motor currents (i.e. no heat decoupling is required)
Internal power supply	-- ¹⁾	✓	✓	--	--	<ul style="list-style-type: none"> Eliminates the need for configuration and connecting an additional control circuit
Supplied from an external source via IO-Link	--	--	--	--	✓	<ul style="list-style-type: none"> Eliminates the need for configuration and connecting an additional control circuit

✓ Available

-- Not available

¹⁾ SIRIUS 3RU21 thermal overload relays use a bimetal contactor and therefore do not require a control supply voltage.

Protection equipment

Overload relays

General data



Features

3RU21

3RB30/3RB31

3RB20/3RB21

3RB22/3RB23

3RB24

Benefits

Other features (continued)

Overload warning

--

--

--

✓

✓

- Indicates imminent tripping of the relay directly on the device due to overload, phase asymmetry or phase failure through flickering of the LEDs or in the case of the 3RB24 as a signal through IO-Link
- Allows the imminent tripping of the relay to be signaled
- Allows measures to be taken in time in the event of inverse-time delayed overloading for an extended period over the current limit
- Eliminates the need for an additional device
- Saves space in the control cabinet
- Reduces wiring outlay and costs

Analog output

--

--

--

✓

✓

- Allows the output of an analog output signal for actuating moving-coil measuring instruments, feeding programmable logic controllers or transfer to bus systems
- Eliminates the need for an additional instrument transformer and signal converter
- Saves space in the control cabinet
- Reduces wiring outlay and costs

✓ Available

-- Not available

Overview of overload relays – matching contactors

Overload relays	Current measurement	Current range	Contactors (type, size, rating in kW)								
			3RT201.	3RT202.	3RT203.	3RT204.	3RT105.	3RT106.	3RT107.	3TF68/3TF69	
Type	A		S00	S0	S2	S3	S6	S10	S12	14	
			3/4/5.5/7.5	5.5/7.5/11/15/18.5	15/18.5/22/30/37	37/45/55	55/75/90	110/132/160	200/250	375/450	

SIRIUS 3RU21 thermal overload relays



3RU211	Integrated	0.11 ... 16	✓	--	--	--	--	--	--	--
3RU212	Integrated	1.8 ... 40	--	✓	--	--	--	--	--	--
3RU213	Integrated	11 ... 80	--	--	✓	--	--	--	--	--
3RU214	Integrated	28 ... 100	--	--	--	✓	--	--	--	--

3RU21

SIRIUS 3RB30 electronic overload relays¹⁾

3RB301	Integrated	0.1 ... 16	✓	--	--	--	--	--	--	--
3RB302	Integrated	0.1 ... 40	--	✓	--	--	--	--	--	--
3RB303	Integrated	12.5 ... 80	--	--	✓	--	--	--	--	--
3RB304	Integrated	32 ... 115	--	--	--	✓	--	--	--	--

3RB30

SIRIUS 3RB31 electronic overload relays¹⁾

3RB311	Integrated	0.1 ... 16	✓	--	--	--	--	--	--	--
3RB312	Integrated	0.1 ... 40	--	✓	--	--	--	--	--	--
3RB313	Integrated	12.5 ... 80	--	--	✓	--	--	--	--	--
3RB314	Integrated	32 ... 115	--	--	--	✓	--	--	--	--

3RB31

SIRIUS 3RB20 electronic overload relays¹⁾

3RB205	Integrated	50 ... 200	--	--	--	--	✓	--	--	--
3RB206	Integrated	55 ... 630	--	--	--	--	--	✓	✓	✓
3RB201 + 3UF18	Integrated	630 ... 820	--	--	--	--	--	--	--	✓

3RB20

SIRIUS 3RB21 electronic overload relays¹⁾

3RB215	Integrated	50 ... 200	--	--	--	--	✓	--	--	--
3RB216	Integrated	55 ... 630	--	--	--	--	--	✓	✓	✓
3RB211 + 3UF18	Integrated	630 ... 820	--	--	--	--	--	--	--	✓

3RB21

SIRIUS 3RB22 to 3RB24 electronic overload relays¹⁾

3RB2283/ 3RB2383/ 3RB2483	3RB2906	0.3 ... 25	✓	✓	--	--	--	--	--	--
	3RB2906	10 ... 100	✓	✓	✓	✓	--	--	--	--
	3RB2956	20 ... 200	--	✓	✓	✓	✓	--	--	--
	3RB2966	63 ... 630	--	--	--	--	--	✓	✓	✓
	3RB2906 + 3UF18	630 ... 820	--	--	--	--	--	--	--	✓

3RB22, 3RB23,
3RB24

- ✓ Can be used
- Cannot be used

¹⁾ "Technical specifications" for the use of overload relays with trip class \geq CLASS 20E, see "Short-circuit protection with fuses for motor feeders" in the Configuration Manual.

Protection equipment

Overload relays

General data

Connection methods

3RU2 thermal overload relays

- Sizes S00 and S0:
 - Main and auxiliary circuit: Either screw or spring-loaded terminals
- Sizes S2 and S3:
 - Main circuit: Screw terminals with box terminal
 - Auxiliary circuit: Either screw or spring-loaded terminals

3RB3 electronic overload relays

- Sizes S00 and S0:
 - Main and auxiliary circuit: Either screw or spring-loaded terminals
- Sizes S2 and S3:
 - Main circuit: Screw terminals with box terminal or as straight-through transformer
 - Auxiliary circuit: Either screw or spring-loaded terminals

3RB2 electronic overload relays

3RB20 and 3RB21 overload relays:

- Size S6:
 - Main circuit: With busbar connection or as straight-through transformer
 - Auxiliary circuit: Either screw or spring-loaded terminals
- Sizes S10/S12:
 - Main circuit: With busbar connection
 - Auxiliary circuit: Either screw or spring-loaded terminals

3RB22 to 3RB24 evaluation modules:

- Screw or spring-loaded terminals

3RB29 current measuring modules:

- Up to size S3: Straight-through transformers
- As from size S6:
 - Main circuit: With busbar connection
 - Auxiliary circuit: Either screw or spring-loaded terminals



Screw terminals



Spring-loaded terminals



Busbar connections



Straight-through transformers

The various terminals and straight-through transformers are indicated in the corresponding tables by the symbols shown on orange backgrounds.

Voltage data

The data for 3-phase power systems according to IEC 60947-4-1 are valid for the following line system configurations:

Voltage U_e	Line system configurations	
	Three-phase four-wire networks	Three-phase three-wire networks
V	V	V
230	--	230
400	230/400	400
440	260/440	440
500	--	500
690	400/690	690 (only as from size S3)
1 000	--	1 000

-- Not specified

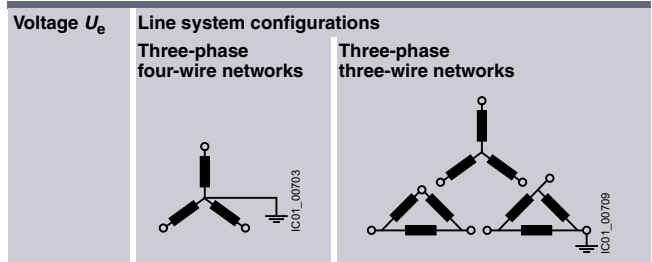

Overview

More information

Homepage, see www.siemens.com/sirius-control
 Industry Mall, see www.siemens.com/product?3RU2
 TIA Selection Tool Cloud (TST Cloud), see www.siemens.com/tstcloud/?node=ThermalOverloadRelay
 Conversion tool, see www.siemens.com/conversion-tool

Application Manual for switching devices with IE3 and IE4 motors, see <https://support.industry.siemens.com/cs/ww/en/view/94770820>
 Equipment Manual, see <https://support.industry.siemens.com/cs/ww/en/view/60298164>
 Characteristics and certificates, see <https://support.industry.siemens.com/cs/ww/en/ps/16271>

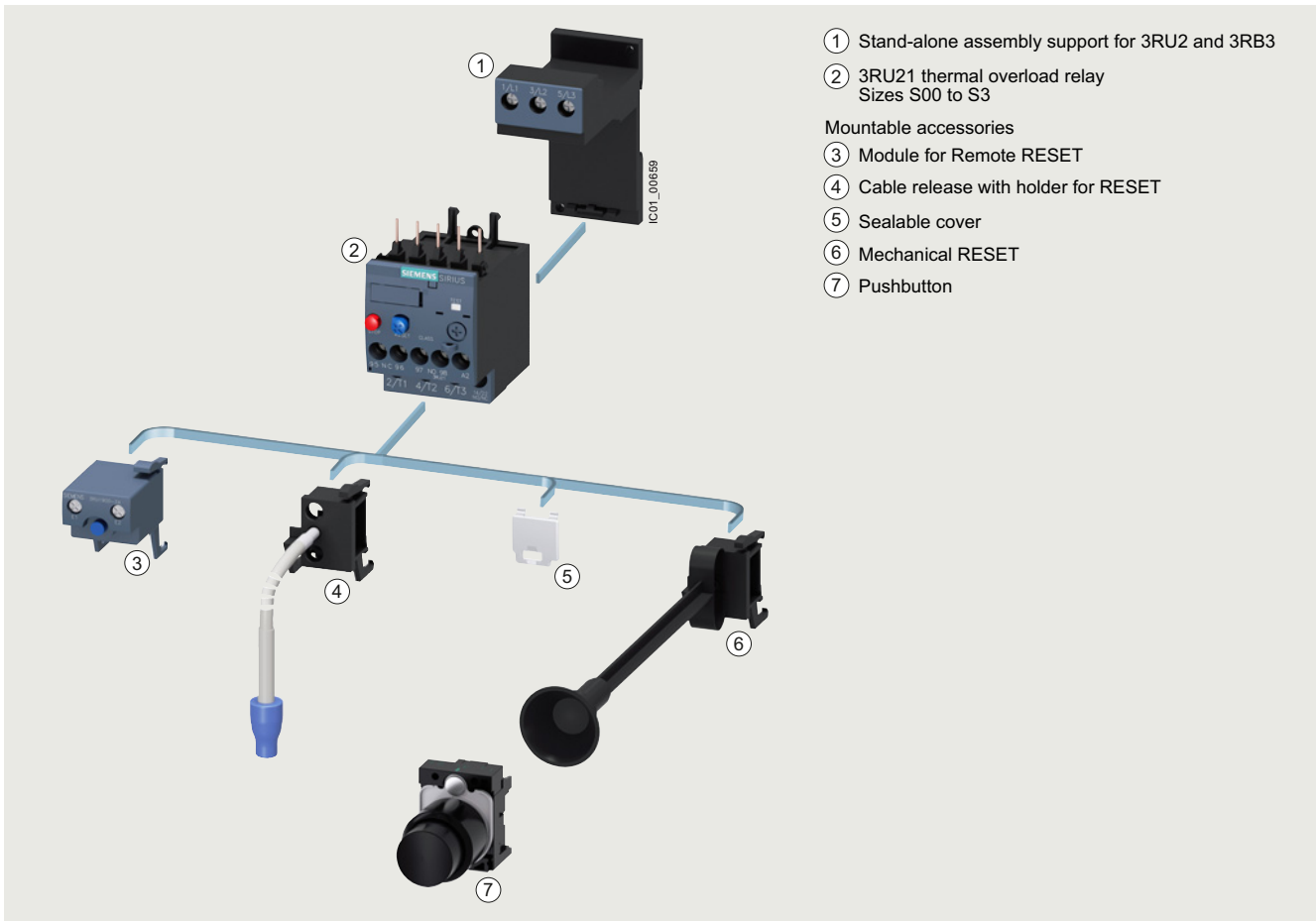

Mountable accessories for 3RU thermal overload relay

Protection equipment

Overload relays

SIRIUS 3RU2 thermal overload relays

3RU2 for standard applications

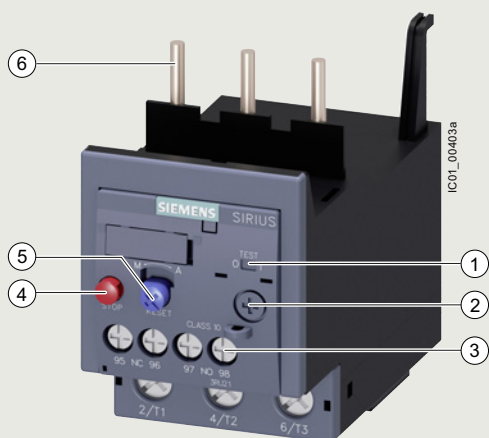

- ① Switch position indicator and TEST function of the wiring: Indicates a trip and enables the wiring test.
- ② Motor current setting: Setting the device to the rated motor current is easy with the large rotary knob.
- ③ Connecting terminals: Depending on the device version, the connecting terminals are screw terminals or spring-loaded terminals for the main and auxiliary circuits.
- ④ STOP button: If the STOP button is pressed, the NC contact is opened. This switches off the contactor downstream. The NC contact is closed again when the button is released.
- ⑤ Selector switch for Manual/Automatic RESET and RESET button: With this switch you can choose between Manual and Automatic RESET. A device set to Manual RESET can be reset locally by pressing the RESET button. A Remote RESET is possible using the RESET modules (accessories), which are independent of size.
- ⑥ Connection for mounting onto contactors: Optimally adapted in electrical, mechanical and design terms to the contactors. The overload relay can be connected directly to the contactor using these pins. Stand-alone installation is possible as an alternative (in conjunction with a terminal support for stand-alone installation).

A sealable transparent cover can be optionally mounted (accessory). It secures the motor current setting against adjustment.

3RU21 thermal overload relays up to 100 A have been designed to provide inverse-time delayed protection for loads with normal starting against impermissibly high temperature rises due to overload or phase failure.

An overload or phase failure results in an increase of the motor current beyond the set rated motor current. Via heating elements, this current rise heats up the bimetal strips inside the device which then bend and as a result trigger the auxiliary contacts by means of a tripping mechanism. The auxiliary contacts then switch off the load by means of a contactor. The break time depends on the ratio between the tripping current and the current setting I_e and is stored in the form of a long-term stable tripping characteristic curve, see [Characteristic curves](#).

The "tripped" status is signaled by means of a switch position indicator. The relay is reset manually or automatically after a recovery time has elapsed.

The 3RU2 thermal overload relays are suitable for operation with frequency converters.

The devices are manufactured in accordance with environmental guidelines and contain environmentally friendly and reusable materials. They comply with all important worldwide standards and approvals.

Use in hazardous areas

The 3RU2 overload relays are certified in accordance with both the European Explosion Protection Directive (ATEX) and the International Explosion Protection Standard (IECEX), see [Certificates](#).

SIRIUS 3RU2136-4.B0 thermal overload relay

Article number scheme

Product versions	Article number
Thermal overload relays	3RU2 □ □ □ - □ □ □ □
Device type	e.g. 1 = CLASS 10, 1 NO + 1 NC □
Size, rated operational current and power	e.g. 16 = 16 A (7.5 kW) for size S00 □ □
Setting range for overload release	e.g. 0A = 0.11 ... 0.16 A □ □
Connection methods	e.g. B = screw terminals □
Installation type	e.g. 0 = mounting on contactor □
Example	3RU2 1 1 6 - 0 A B 0

Note:

The article number scheme shows an overview of product versions for better understanding of the logic behind the article numbers.

For your orders, please use the article numbers quoted in the selection and ordering data.

Benefits

The most important features and benefits of the 3RU21 thermal overload relays are listed in the overview table (see "General data", page 7/76 onwards).

Application

Industries

The 3RU21 thermal overload relays are suitable for customers from all industries who want to guarantee optimum inverse-time delayed protection of their electrical loads (e.g. motors) under normal starting conditions (CLASS 10, 10A).

Application

The 3RU21 thermal overload relays have been designed for the protection of three-phase and single-phase AC and DC motors.

If single-phase AC or DC loads are to be protected by the 3RU21 thermal overload relays, all three bimetal strips must be heated. For this purpose, all main conducting paths of the relay must be connected in series.

Ambient conditions

3RU21 thermal overload relays compensate temperature in the temperature range from -40 to +60 °C according to IEC 60947-4-1. At temperatures from +60 to +70 °C, the upper set value of the setting range has to be reduced by a specific factor.

Use of SIRIUS protection devices in conjunction with IE3 and IE4 motors

Note:

For the use of 3RU21 thermal overload relays in conjunction with highly efficient IE3 and IE4 motors, please observe the information on dimensioning and configuring, see [Application Manual](#).

For more information, see [page 1/8](#).



Technical specifications

More information

System Manual for modular system, see <https://support.industry.siemens.com/cs/ww/en/view/60311318>
 Configuration Manual for load feeders, see <https://support.industry.siemens.com/cs/ww/en/view/39714188>

Equipment Manual, see <https://support.industry.siemens.com/cs/ww/en/view/60298164>
 Technical specifications, see <https://support.industry.siemens.com/cs/ww/en/ps/16270/tid>

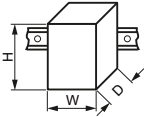
The following technical information is intended to provide an initial overview of the various types of devices and functions.

Type		3RU2116	3RU2126	3RU2136	3RU2146
Size		S00	S0	S2	S3
Dimensions (W x H x D) (overload relay with stand-alone installation support)					
• Screw terminals	mm	45 x 89 x 80	45 x 97 x 95	55 x 105 x 117	70 x 106 x 124
• Spring-loaded terminals	mm	45 x 102 x 79	45 x 114 x 95	55 x 105 x 117	70 x 106 x 124
General data					
Tripping in the event of		Overload and phase failure			
Trip class according to IEC 60947-4-1	CLASS	10		10, 10A	
Phase failure sensitivity		Yes			
Overload warning		No			
Reset and recovery					
• Reset options after tripping		Manual, Auto and Remote RESET (Remote RESET in conjunction with the appropriate accessories)			
• Recovery time		Depends on the strength of the tripping current and characteristic			
- For Automatic RESET	min.	Depends on the strength of the tripping current and characteristic			
- For Manual RESET	min.	Depends on the strength of the tripping current and characteristic			
- For Remote RESET	min.	Depends on the strength of the tripping current and characteristic			
Features					
• Display of operating state on device		Yes, by means of TEST function/switch position indicator slide			
• TEST function		Yes			
• RESET button		Yes			
• STOP button		Yes			
Protection of motors in hazardous environments					
• Certificate of suitability/explosion protection type according to ATEX Directive 2014/34/EU		DMT 98 ATEX G 001  II (2) GD			
• According to international standard IECEx		IECEx BVS 15.0046 see https://support.industry.siemens.com/cs/ww/en/ps/16270/cert			

Protection equipment

Overload relays

SIRIUS 3RU2 thermal overload relays

3RU2 for standard applications

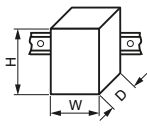
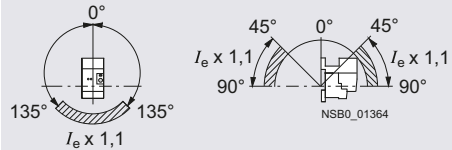
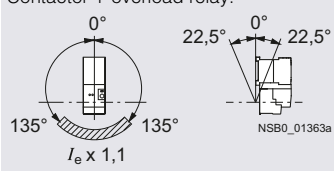
Type		3RU2116	3RU2126	3RU2136	3RU2146
Size		S00	S0	S2	S3
Dimensions (W x H x D) (overload relay with stand-alone installation support)					
• Screw terminals	mm	45 x 89 x 80	45 x 97 x 95	55 x 105 x 117	70 x 106 x 124
• Spring-loaded terminals	mm	45 x 102 x 79	45 x 114 x 95	55 x 105 x 117	70 x 106 x 124
General data (continued)					
Ambient temperature					
• Storage/transport	°C	-55 ... +80			
• Operation	°C	-40 ... +70			
• Temperature compensation	°C	Up to +60			
• Permissible rated current at					
- Temperature inside control cabinet 60 °C	%	100 (current reduction is required above +60 °C)			
- Temperature inside control cabinet 70 °C	%	87			
Repeat terminals					
• Coil repeat terminals		Yes	Not required		
• Auxiliary contact repeat terminals		Yes	Not required		
Degree of protection IP on the front according to IEC 60529					
IP20 (screw terminals and spring-loaded terminals)					
Touch protection on the front according to IEC 60529					
Finger-safe for vertical touching from the front (screw and spring-loaded terminals)					
Shock resistance with sine according to IEC 60068-2-27					
	g/ms	15/11 (auxiliary contacts 95/96 and 97/98: 8 g/11 ms)			
Electromagnetic compatibility (EMC)					
• Interference immunity		Not relevant			
• Emitted interference		Not relevant			
Installation altitude above sea level					
	m	Up to 2 000			
Mounting position					
The diagrams show the permissible mounting positions for mounting on contactors and stand-alone installation. For mounting position in the hatched area, a setting correction of 10% must be implemented.					
Stand-alone installation:					
					
Contactor + overload relay:					
					
Type of mounting					
For mounting on contactor or stand-alone installation with terminal support, screw and snap-on mounting on DIN rail.					

Protection equipment

Overload relays

SIRIUS 3RU2 thermal overload relays

3RU2 for standard applications

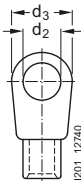
Type		3RU2116	3RU2126	3RU2136	3RU2146
Size		S00	S0	S2	S3
Main circuit					
Rated insulation voltage U_i (pollution degree 3)	V	690			1 000
Rated impulse withstand voltage U_{imp}	kV	6			8
Rated operational voltage U_e	V	690			
Type of current					
• Direct current		Yes			
• Alternating current		Yes, frequency range up to 400 Hz			
Current setting	A	0.11 ... 0.16 to 11 ... 16	1.8 ... 2.5 to 34 ... 40	11 ... 16 to 70 ... 80	28 ... 40 to 80 ... 100
Power loss per unit (max.)	W	4.8 ... 7.5	5.7 ... 9.6	10.5 ... 18.9	13.5 ... 21
Short-circuit protection					
• With fuse without contactor		See "Selection and ordering data", pages 7/89 ... 7/92			
• With fuse and contactor		"Short-Circuit Protection with Fuses/Motor Starter Protectors for Motor Feeders", see Configuration Manual.			
Protective separation between main and auxiliary conducting paths According to IEC 60947-1					
• Screw terminals or ring cable lug connections	V	440	690: Setting range \leq 25 A	690	
• Spring-loaded terminals	V	440	440: Setting range $>$ 25 A	690	
Conductor cross-sections of main circuit					
Connection type		⊕ Screw terminals			⊕ Screw terminals with box terminal
Terminal screw		M3, Pozidriv size 2	M4, Pozidriv size 2	M6, Pozidriv size 2	4 mm Allen screw
Operating devices	mm	∅ 5 ... 6	∅ 5 ... 6	∅ 5 ... 6	4 mm Allen screw
Prescribed tightening torque	Nm	0.8 ... 1.2	2 ... 2.5	3 ... 4.5	4.5 ... 6
Conductor cross-sections (min./max.), one or two conductors can be connected					
• Solid or stranded	mm ²	2 x (0.5 ... 1.5) ¹⁾ , 2 x (0.75 ... 2.5) ¹⁾ , max. 2 x 4	2 x (1 ... 2.5) ¹⁾ , 2 x (2.5 ... 10) ¹⁾	2 x (2.5 ... 35) ¹⁾ , 1 x (2.5 ... 50) ¹⁾	2 x (2.5 ... 16) ¹⁾ , 2 x (10 ... 50) ¹⁾ , 1 x (10 ... 70) ¹⁾
• Finely stranded with end sleeve (DIN 46228)	mm ²	2 x (0.5 ... 1.5) ¹⁾ , 2 x (0.75 ... 2.5) ¹⁾	2 x (1 ... 2.5) ¹⁾ , 2 x (2.5 ... 6) ¹⁾ , max. 1 x 10	2 x (1 ... 25) ¹⁾ , 1 x (1 ... 35) ¹⁾	2 x (2.5 ... 35) ¹⁾ , 1 x (2.5 ... 50) ¹⁾
• AWG cables, solid or stranded	AWG	2 x (20 ... 16) ¹⁾ , 2 x (18 ... 14) ¹⁾ , 2 x 12	2 x (16 ... 12) ¹⁾ , 2 x (14 ... 8) ¹⁾	2 x (18 ... 2) ¹⁾ , 1 x (18 ... 1) ¹⁾	2 x (10 ... 1/0) ¹⁾ , 1 x (10 ... 2/0) ¹⁾
Removable box terminals ²⁾					
• With copper bars ³⁾	mm	--	--	--	2 x 12 x 4
• With cable lugs ⁴⁾					
- Terminal screw		--	--	--	M6
- Prescribed tightening torque	Nm	--	--	--	4.5 ... 6
- Usable ring cable lugs	mm	--	--	--	$d_2 = \text{min. } 6.3$ $d_3 = \text{max. } 19$
					
Connection type		⊕ Spring-loaded terminals			
Operating devices	mm	3.0 x 0.5 and 3.5 x 0.5			
Conductor cross-sections (min./max.), one conductor can be connected					
• Solid or stranded	mm ²	1 x (0.5 ... 4)	1 x (1 ... 10)	--	
• Finely stranded without end sleeve	mm ²	1 x (0.5 ... 2.5)	1 x (1 ... 6)	--	
• Finely stranded with end sleeve (DIN 46228)	mm ²	1 x (0.5 ... 2.5)	1 x (1 ... 6)	--	
• AWG cables, solid or stranded	AWG	1 x (20 ... 12)	1 x (18 ... 8)	--	
• Max. external diameter of the conductor insulation	mm	3.6	6.4	--	

¹⁾ If two different conductor cross-sections are connected to one clamping point, both cross-sections must be in the range specified.

²⁾ Cable lug and busbar connection possible after removing the box terminals.

³⁾ If bars larger than 12 mm x 10 mm are connected, a 3RT2946-4EA2 cover is needed to maintain the required phase clearance, see page 7/94.



⁴⁾ If conductors larger than 25 mm² are connected, the 3RT2946-4EA2 cover is needed to maintain the required phase clearance, see page 7/94.

Protection equipment

Overload relays

SIRIUS 3RU2 thermal overload relays

3RU2 for standard applications

Type		3RU2116	3RU2126	3RU2136	3RU2146
Size		S00	S0	S2	S3
Auxiliary circuit					
Number of NO contacts		1			
Number of NC contacts		1			
Auxiliary contacts – Assignment		1 NO for the signal "tripped"; 1 NC for disconnecting the contactor			
Rated insulation voltage U_i (pollution degree 3)	V	690			
Rated impulse withstand voltage U_{imp}	kV	6			
Contact rating of the auxiliary contacts					
• NC, NO contacts with alternating current AC-15, rated operational current I_e at U_e					
- 24 V	A	3			
- 120 V	A	3			
- 125 V	A	3			
- 230 V	A	2			
- 400 V	A	1			
- 600 V	A	0.75			
- 690 V	A	0.75			
• NC, NO contacts with direct current DC-13, rated operational current I_e at U_e					
- 24 V	A	1			
- 110 V	A	0.22			
- 125 V	A	0.22			
- 220 V	A	0.11			
• Contact reliability (suitability for PLC control; 17 V, 5 mA)					
		Yes			
Short-circuit protection					
• With fuse					
- Operational class gG	A	6			
- Quick	A	10			
• With miniature circuit breaker (C characteristic)					
	A	6 (up to $I_k \leq 0.5$ kA; $U \leq 260$ V)			
Reliable operational voltage for protective separation between auxiliary conducting paths According to IEC 60947-1	V	440			
CSA, UL and UR rated data					
Auxiliary circuit – Switching capacity		B600, R300			
Conductor cross-sections for auxiliary circuit					
Connection type		 Screw terminals			
Terminal screw		M3, Pozidriv size 2			
Operating devices	mm	Ø 5 ... 6			
Prescribed tightening torque	Nm	0.8 ... 1.2			
Conductor cross-sections (min./max.), one or two conductors can be connected					
• Solid or stranded	mm ²	2 x (0.5 ... 1.5) ¹⁾ , 2 x (0.75 ... 2.5) ¹⁾			
• Finely stranded with end sleeve (DIN 46228)	mm ²	2 x (0.5 ... 1.5) ¹⁾ , 2 x (0.75 ... 2.5) ¹⁾			
• AWG cables, solid or stranded	AWG	2 x (20 ... 16) ¹⁾ , 2 x (18 ... 14) ¹⁾			
Connection type		 Spring-loaded terminals			
Operating devices	mm	3.0 x 0.5 and 3.5 x 0.5			
Conductor cross-sections (min./max.), one or two conductors can be connected					
• Solid or stranded	mm ²	2 x (0.5 ... 2.5)			
• Finely stranded without end sleeve	mm ²	2 x (0.5 ... 2.5)			
• Finely stranded with end sleeve (DIN 46228)	mm ²	2 x (0.5 ... 1.5)			
• AWG cables, solid or stranded	AWG	2 x (20 ... 14)			
• Max. external diameter of the conductor insulation	mm	3.6			

¹⁾ If two different conductor cross-sections are connected to one clamping point, both cross-sections must be in the range specified.

IE3/IE4 ready

3RU2 for standard applications

Selection and ordering data

3RU21 thermal overload relays for mounting on contactor¹⁾, sizes S00 and S0, CLASS 10

Features and technical specifications:

- Connection methods
Main and auxiliary circuit: Either screw or spring-loaded terminals
- Overload and phase failure protection
- Auxiliary contacts 1 NO + 1 NC
- Manual and Automatic RESET
- Switch position indicator

- TEST function
- STOP button
- Sealable covers (optional accessory)

PU (UNIT, SET, M) = 1
 PS* = 1 unit
 PG = 41F





3RU2116-..B0

3RU2116-..C0

3RU2126-..B0

3RU2126-..C0

Size contactor	Trip class	Rated power for three-phase motors, rated value ²⁾	Current setting value of the inverse-time delayed overload release	Short-circuit protection with fuse, type of coordination "2", operational class gG ³⁾	Screw terminals 		Spring-loaded terminals 		
					Article No.	Price per PU	Article No.	Price per PU	
CLASS	KW	A	A						
Size S00									
S00	10	0.04	0.11 ... 0.16	0.5	3RU2116-0AB0 3RU2116-0BB0 3RU2116-0CB0 3RU2116-0DB0		3RU2116-0AC0 3RU2116-0BC0 3RU2116-0CC0 3RU2116-0DC0		
	10	0.06	0.14 ... 0.2	1					
	10	0.06	0.18 ... 0.25	1					
	10	0.09	0.22 ... 0.32	1.6					
	10	0.09	0.28 ... 0.4	2	3RU2116-0EB0 3RU2116-0FB0 3RU2116-0GB0 3RU2116-0HB0		3RU2116-0EC0 3RU2116-0FC0 3RU2116-0GC0 3RU2116-0HC0		
		10	0.12	0.35 ... 0.5					2
		10	0.18	0.45 ... 0.63					2
		10	0.18	0.55 ... 0.8					4
	10	0.25	0.7 ... 1	4	3RU2116-0JB0 3RU2116-0KB0 3RU2116-1AB0 3RU2116-1BB0		3RU2116-0JC0 3RU2116-0KC0 3RU2116-1AC0 3RU2116-1BC0		
		10	0.37	0.9 ... 1.25					4
		10	0.55	1.1 ... 1.6					6
		10	0.75	1.4 ... 2					6
	10	0.75	1.8 ... 2.5	10	3RU2116-1CB0 3RU2116-1DB0 3RU2116-1EB0 3RU2116-1FB0		3RU2116-1CC0 3RU2116-1DC0 3RU2116-1EC0 3RU2116-1FC0		
		10	1.1	2.2 ... 3.2					10
		10	1.5	2.8 ... 4					16
		10	1.5	3.5 ... 5					20
	10	2.2	4.5 ... 6.3	20	3RU2116-1GB0 3RU2116-1HB0 3RU2116-1JB0 3RU2116-1KB0		3RU2116-1GC0 3RU2116-1HC0 3RU2116-1JC0 3RU2116-1KC0		
		10	3	5.5 ... 8					25
		10	4	7 ... 10					35
		10	5.5	9 ... 12.5					35
10	7.5	11 ... 16	40	3RU2116-4AB0		3RU2116-4AC0			
Size S0									
S0	10	0.75	1.8 ... 2.5	10	3RU2126-1CB0 3RU2126-1DB0 3RU2126-1EB0 3RU2126-1FB0		3RU2126-1CC0 3RU2126-1DC0 3RU2126-1EC0 3RU2126-1FC0		
	10	1.1	2.2 ... 3.2	10					
	10	1.5	2.8 ... 4	16					
	10	1.5	3.5 ... 5	20					
	10	2.2	4.5 ... 6.3	20	3RU2126-1GB0 3RU2126-1HB0 3RU2126-1JB0 3RU2126-1KB0		3RU2126-1GC0 3RU2126-1HC0 3RU2126-1JC0 3RU2126-1KC0		
		10	3	5.5 ... 8					25
		10	4	7 ... 10					35
		10	5.5	9 ... 12.5					35
	10	7.5	11 ... 16	40	3RU2126-4AB0 3RU2126-4BB0 3RU2126-4CB0 3RU2126-4DB0		3RU2126-4AC0 3RU2126-4BC0 3RU2126-4CC0 3RU2126-4DC0		
		10	7.5	14 ... 20					50
		10	11	17 ... 22					63
		10	11	20 ... 25					63
	10	15	23 ... 28	63	3RU2126-4NB0 3RU2126-4EB0 3RU2126-4PB0 3RU2126-4FB0		3RU2126-4NC0 3RU2126-4EC0 3RU2126-4PC0 3RU2126-4FC0		
		10	15	27 ... 32					80
		10	18.5	30 ... 36					80
		10	18.5	34 ... 40					80

¹⁾ With the appropriate terminal supports (see page 7/93), the 3RU2 overload relays for mounting on contactors can also be installed as stand-alone units.

²⁾ Guide value for 4-pole standard motors at 50 Hz 400 V AC. The actual starting and rated data of the motor to be protected must be considered when selecting the units.

³⁾ Maximum protection by fuse only for overload relays, type of coordination "2". For fuse values in connection with contactors, see Configuration Manual.

Protection equipment

Overload relays

SIRIUS 3RU2 thermal overload relays

3RU2 for standard applications **IE3/IE4 ready**

3RU21 thermal overload relays for mounting on contactor¹⁾, sizes S2 and S3, CLASS 10 or 10A

Features and technical specifications:

- Connection methods
 - Main circuit: Screw terminals with box terminal
 - Auxiliary circuit: Either screw or spring-loaded terminals
- Overload and phase failure protection
- Auxiliary contacts 1 NO + 1 NC
- Manual and Automatic RESET
- Switch position indicator

- TEST function
- STOP button
- Sealable covers (optional accessory)

PU (UNIT, SET, M) = 1
 PS* = 1 unit
 PG = 41F





3RU2136...B0

3RU2136...D0

3RU2146-4.B0

3RU2146-4.D0

Size contactor	Trip class	Rated power for three-phase motors, rated value ²⁾	Current setting value of the inverse-time delayed overload release	Short-circuit protection with fuse, type of coordination "2", operational class gG ³⁾	Screw terminals 		Spring-loaded terminals  (on auxiliary current side)	
					Article No.	Price per PU	Article No.	Price per PU
CLASS	kW	A	A					
Size S2								
S2	10	3	5.5 ... 8	25	3RU2136-1HB0 3RU2136-1JB0 3RU2136-1KB0 3RU2136-4AB0 3RU2136-4BB0 3RU2136-4DB0 3RU2136-4EB0	3RU2136-1HD0 3RU2136-1JD0 3RU2136-1KD0 3RU2136-4AD0 3RU2136-4BD0 3RU2136-4DD0 3RU2136-4ED0		
	10	4	7 ... 10	35				
	10	5.5	9 ... 12.5	35				
	10	7.5	11 ... 16	40				
	10	7.5	14 ... 20	50				
	10	11	18 ... 25	63				
	10	15	22 ... 32	80				
	10	18.5	28 ... 40	80	3RU2136-4FB0 3RU2136-4GB0 3RU2136-4HB0 3RU2136-4QB0 3RU2136-4JB0	3RU2136-4FD0 3RU2136-4GD0 3RU2136-4HD0 3RU2136-4QD0 3RU2136-4JD0		
	10	22	36 ... 45	100				
	10	22	40 ... 50	100				
	10	30	47 ... 57	100				
	10A	30	54 ... 65	125	3RU2136-4KB0 3RU2136-4RB0	3RU2136-4KD0 3RU2136-4RD0		
	10A	37	62 ... 73	160				
	10A	37	70 ... 80	160				
Size S3								
S3	10	18.5	28 ... 40	80	3RU2146-4FB0 3RU2146-4HB0 3RU2146-4JB0 3RU2146-4KB0 3RU2146-4LB0 3RU2146-4MB0	3RU2146-4FD0 3RU2146-4HD0 3RU2146-4JD0 3RU2146-4KD0 3RU2146-4LD0 3RU2146-4MD0		
	10	22	36 ... 50	125				
	10	30	45 ... 63	125				
	10	37	57 ... 75	160				
	10	45	70 ... 90	160				
	10	45	80 ... 100 ⁴⁾	200				

¹⁾ With the appropriate terminal supports (see page 7/93), the 3RU2 overload relays for mounting on contactors can also be installed as stand-alone units.

²⁾ Guide value for 4-pole standard motors at 50 Hz 400 V AC. The actual starting and rated data of the motor to be protected must be considered when selecting the units.

³⁾ Maximum protection by fuse only for overload relays, type of coordination "2". For fuse values in connection with contactors, see Configuration Manual.

⁴⁾ For overload relays > 100 A, see 3RB2 electronic overload relays, page 7/107 onwards.

Protection equipment

Overload relays

SIRIUS 3RU2 thermal overload relays

IE3/IE4 ready 3RU2 for standard applications

3RU21 thermal overload relays for stand-alone installation, sizes S00 and S0, CLASS 10

Features and technical specifications:

- Connection methods
Main and auxiliary circuit: Either screw or spring-loaded terminals
- Overload and phase failure protection
- Auxiliary contacts 1 NO + 1 NC
- Manual and Automatic RESET
- Switch position indicator

- TEST function
- STOP button
- Sealable covers (optional accessory)

 PU (UNIT, SET, M) = 1
 PS* = 1 unit
 PG = 41F

3RU2116-..B1

3RU2116-..C1

3RU2126-4.B1

3RU2126-4.C1

Size	contactor	Trip class	Rated power for three-phase motors, rated value ¹⁾	Current setting value of the inverse-time delayed overload release	Short-circuit protection with fuse, type of coordination "2", operational class gG ²⁾	Screw terminals		Spring-loaded terminals	
						Article No.	Price per PU	Article No.	Price per PU
CLASS		kW	A	A					
Size S00									
S00	10	0.04	0.11 ... 0.16	0.5	3RU2116-0AB1		3RU2116-0AC1		
		0.06	0.14 ... 0.2	1	3RU2116-0BB1		3RU2116-0BC1		
		0.06	0.18 ... 0.25	1	3RU2116-0CB1		3RU2116-0CC1		
		0.09	0.22 ... 0.32	1.6	3RU2116-0DB1		3RU2116-0DC1		
	10	0.09	0.28 ... 0.4	2	3RU2116-0EB1		3RU2116-0EC1		
		0.12	0.35 ... 0.5	2	3RU2116-0FB1		3RU2116-0FC1		
		0.18	0.45 ... 0.63	2	3RU2116-0GB1		3RU2116-0GC1		
		0.18	0.55 ... 0.8	4	3RU2116-0HB1		3RU2116-0HC1		
		0.25	0.7 ... 1	4	3RU2116-0JB1		3RU2116-0JC1		
		0.37	0.9 ... 1.25	4	3RU2116-0KB1		3RU2116-0KC1		
	10	0.55	1.1 ... 1.6	6	3RU2116-1AB1		3RU2116-1AC1		
		0.75	1.4 ... 2	6	3RU2116-1BB1		3RU2116-1BC1		
		0.75	1.8 ... 2.5	10	3RU2116-1CB1		3RU2116-1CC1		
		1.1	2.2 ... 3.2	10	3RU2116-1DB1		3RU2116-1DC1		
	10	1.5	2.8 ... 4	16	3RU2116-1EB1		3RU2116-1EC1		
		1.5	3.5 ... 5	20	3RU2116-1FB1		3RU2116-1FC1		
		2.2	4.5 ... 6.3	20	3RU2116-1GB1		3RU2116-1GC1		
		3	5.5 ... 8	25	3RU2116-1HB1		3RU2116-1HC1		
	10	4	7 ... 10	35	3RU2116-1JB1		3RU2116-1JC1		
		5.5	9 ... 12.5	35	3RU2116-1KB1		3RU2116-1KC1		
10	7.5	11 ... 16	40	3RU2116-4AB1		3RU2116-4AC1			
Size S0									
S0	10	7.5	14 ... 20	50	3RU2126-4BB1		3RU2126-4BC1		
		11	17 ... 22	63	3RU2126-4CB1		3RU2126-4CC1		
		11	20 ... 25	63	3RU2126-4DB1		3RU2126-4DC1		
	10	15	23 ... 28	63	3RU2126-4NB1		3RU2126-4NC1		
		15	27 ... 32	80	3RU2126-4EB1		3RU2126-4EC1		
		18.5	30 ... 36	80	3RU2126-4PB1		3RU2126-4PC1		
	10	18.5	34 ... 40	80	3RU2126-4FB1		3RU2126-4FC1		

¹⁾ Guide value for 4-pole standard motors at 50 Hz 400 V AC. The actual starting and rated data of the motor to be protected must be considered when selecting the units.

²⁾ Maximum protection by fuse only for overload relays, type of coordination "2". For fuse values in connection with contactors, see [Configuration Manual](#).

Protection equipment

Overload relays

SIRIUS 3RU2 thermal overload relays

3RU2 for standard applications **IE3/IE4 ready**

3RU21 thermal overload relays for stand-alone installation, sizes S2 and S3, CLASS 10 or 10A

Features and technical specifications:

- Connection methods
 - Main circuit: Screw terminals with box terminal
 - Auxiliary circuit: Either screw or spring-loaded terminals
- Auxiliary contacts 1 NO + 1 NC
- Manual and Automatic RESET
- Switch position indicator
- TEST function
- STOP button
- Sealable covers (optional accessory)

PU (UNIT, SET, M) = 1
 PS* = 1 unit
 PG = 41F





3RU2136-4.B1

3RU2136-4.D1

3RU2146-4.B1

3RU2146-4.D1

Size contactor	Trip class	Rated power for three-phase motors, rated value ¹⁾	Current setting value of the inverse-time delayed overload release	Short-circuit protection with fuse, type of coordination "2", operational class gG ²⁾	Screw terminals 		Spring-loaded terminals 	
					Article No.	Price per PU	Article No.	Price per PU
CLASS	kW	A	A					
Size S2								
S2	10	15	22 ... 32	80	3RU2136-4EB1		3RU2136-4ED1	
	10	18.5	28 ... 40	80				
	10	22	36 ... 45	100				
	10	22	40 ... 50	100	3RU2136-4HB1		3RU2136-4HD1	
	10	30	47 ... 57	100				
	10	30	54 ... 65	125				
10A	37	62 ... 73	160	3RU2136-4KB1		3RU2136-4KD1		
10A	37	70 ... 80	160					
Size S3								
S3	10	30	45 ... 63	125	3RU2146-4JB1		3RU2146-4JD1	
	10	37	57 ... 75	160				
	10	45	70 ... 90	160				
	10	45	80 ... 100 ³⁾	200				

¹⁾ Guide value for 4-pole standard motors at 50 Hz 400 V AC. The actual starting and rated data of the motor to be protected must be considered when selecting the units.

²⁾ Maximum protection by fuse only for overload relays, type of coordination "2". For fuse values in connection with contactors, see Configuration Manual.









³⁾ For overload relays > 100 A, see 3RB2 electronic overload relays, page 7/107 onwards.

Overview

The following optional accessories are available for the 3RU21 thermal overload relays:

- Size-specific terminal support for stand-alone installation, in sizes S00 and S0 also with spring-loaded terminals
- Mechanical RESET (for all sizes)
- Cable release for resetting devices which are difficult to access (for all sizes)
- Electrical Remote RESET module in three voltage variants (for all sizes)
- Sealable cover (for all sizes)
- Size-specific terminal covers for devices with screw terminals (box terminals)

Selection and ordering data









Version	Size	Article No.	Price per PU	PU (UNIT, SET, M)	PS*	PG
Terminal supports for stand-alone installation						
 <p>Terminal supports for overload relays with screw terminals</p> <p>For separate mounting of the overload relays; screw and snap-on mounting on DIN rail</p>		<p>Screw terminals </p>				
3RU2916-3AA01	S00	3RU2916-3AA01		1	1 unit	41F
3RU2916-3AC01	S0	3RU2916-3AC01		1	1 unit	41F
	S2	3RU2936-3AA01		1	1 unit	41F
	S3	3RU2946-3AA01		1	1 unit	41F
 <p>Terminal supports for overload relays with spring-loaded terminals</p> <p>For separate mounting of the overload relays; screw and snap-on mounting on DIN rail</p>		<p>Spring-loaded terminals </p>				
3RU2926-3AA01	S00	3RU2916-3AC01		1	1 unit	41F
3RU2926-3AC01	S0	3RU2926-3AC01		1	1 unit	41F
 <p>3RU2936-3AA01</p>						
 <p>3RU2946-3AA01</p>						
Mechanical RESET						
 <p>3RU2900-1A</p>		<p>Resetting plungers, holders and formers S00 ... S3</p> <p>3RU2900-1A</p>				
 <p>3SU1200-0FB10-0AA0</p>		<p>Pushbuttons with extended stroke S00 ... S3 (12 mm), IP65, ø 22 mm</p> <p>3SU1200-0FB10-0AA0</p>				
 <p>3SU1900-0KG10-0AA0</p>		<p>Extension plungers S00 ... S3</p> <p>For compensation of the distance between the pushbutton and the resetting plunger of the relay</p> <p>3SU1900-0KG10-0AA0</p>				

Protection equipment

Overload relays

SIRIUS 3RU2 thermal overload relays

Accessories

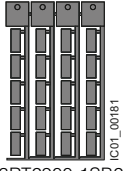
Version	Size	Article No.	Price per PU	PU (UNIT, SET, M)	PS*	PG		
Cable releases with holder for RESET								
	For \varnothing 6.5 mm holes in the control panel; max. control panel thickness 8 mm							
	<ul style="list-style-type: none"> Length 400 mm Length 600 mm 	S00 ... S3	3RU2900-1B	1	1 unit	41F		
		S00 ... S3	3RU2900-1C	1	1 unit	41F		
Modules for Remote RESET, electrical								
	Operating range 0.85 ... 1.1 x U_N , Power consumption 80 VA AC, 70 W DC, ON period 0.2 ... 4 s, Switching frequency 60/h							
	<ul style="list-style-type: none"> 24 ... 30 V AC/DC 110 ... 127 V AC/DC 220 ... 250 V AC/DC 	S00 ... S3	3RU1900-2AB71	1	1 unit	41F		
		S00 ... S3	3RU1900-2AF71	1	1 unit	41F		
		S00 ... S3	3RU1900-2AM71	1	1 unit	41F		
Sealable covers								
	For covering the setting knobs	S00 ... S3	3RV2908-0P	100	10 units	41E		
Terminal covers								
	Covers for contactors with cable lug and busbar connections	S3	3RT1946-4EA1	1	1 unit	41B		
	For complying with the phase clearances and as touch protection if box terminal is removed							
	Covers for devices with screw terminals (box terminals)		Screw terminals 					
	Additional touch protection for fastening to the box terminals							
	<ul style="list-style-type: none"> Main current level 	S2	3RT2936-4EA2	1	1 unit	41B		
		S3	3RT2946-4EA2	1	1 unit	41B		
General accessories								
Version	Size	Color	For overload relays	Article No.	Price per PU	PU (UNIT, SET, M)	PS*	PG
Tools for opening spring-loaded terminals								
	Screwdrivers	Length approx. 200 mm, 3.0 mm x 0.5 mm	Titanium gray/black, partially insulated	Main and auxiliary circuit connection: 3RU2				
	For all SIRIUS devices with spring-loaded terminals				Spring-loaded terminals 	1	1 unit	41B
				3RA2908-1A				
Blank labels								
	Unit labeling plates¹⁾	20 mm x 7 mm	Titanium gray	3RU2		100	340 units	41B
	For SIRIUS devices				3RT2900-1SB20			
	Adhesive labels	19 mm x 6 mm	Titanium gray	3RB2		100	3 060 units	41B
	For SIRIUS devices				3RT2900-1SB60			

¹⁾ PC labeling system for individual inscription of unit labeling plates available from: murrplastik Systemtechnik GmbH (see page 16/18).

Overview

More information

Homepage, see www.siemens.com/sirius-control
 Industry Mall, see www.siemens.com/product?3RB3
 TIA Selection Tool Cloud (TST Cloud), see www.siemens.com/tstcloud/?node=ElectronicOverloadRelay
 Conversion tool, see www.siemens.com/conversion-tool

Application Manual for switching devices with IE3 and IE4 motors, see <https://support.industry.siemens.com/cs/ww/en/view/94770820>
 Equipment Manual, see <https://support.industry.siemens.com/cs/ww/en/view/60298164>
 Characteristics and certificates, see <https://support.industry.siemens.com/cs/ww/en/ps/16276>

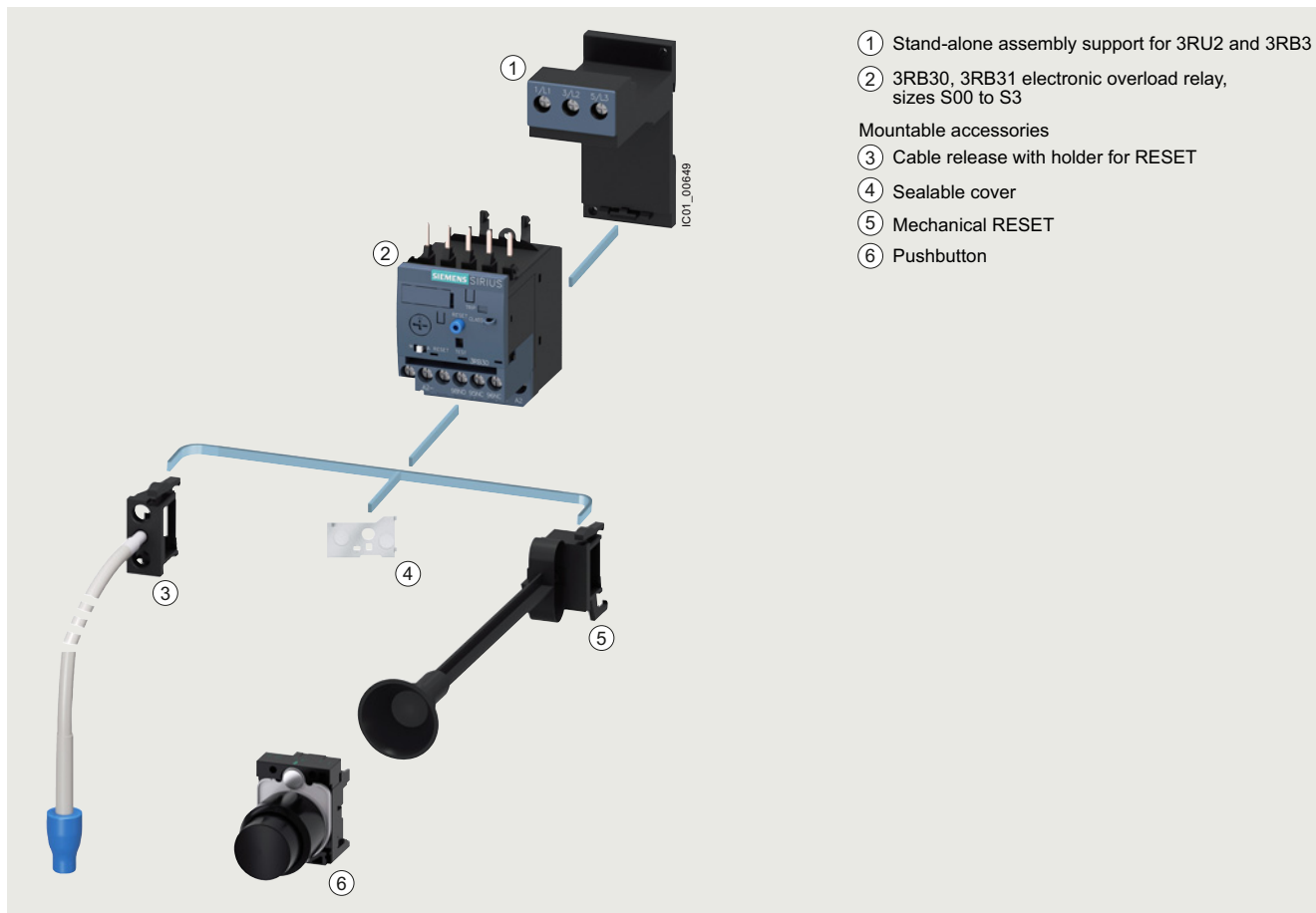

Mountable accessories for 3RB30 and 3RB31 electronic overload relays

Protection equipment

Overload relays

SIRIUS 3RB3 electronic overload relays

3RB30, 3RB31 for standard applications

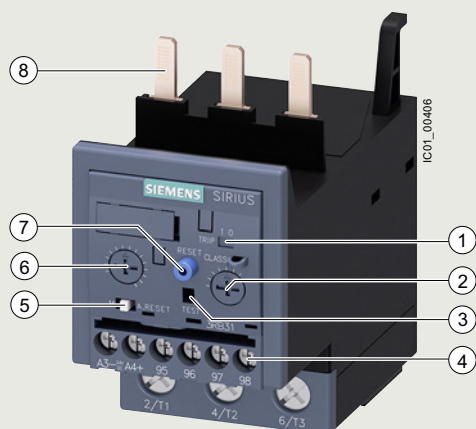

- ① Switch position indicator and TEST function of the wiring:
Indicates a trip and enables the wiring test.
- ② Trip class setting/internal ground-fault detection (only 3RB31):
Using the rotary switch you can set the required trip class and activate the internal ground-fault detection dependent on the starting conditions.
- ③ Solid-state test (device test):
Enables a test of all important device components and functions.
- ④ Connecting terminals (removable terminal block for auxiliary circuits):
Depending on the device version, the connecting terminals are screw terminals or spring-loaded terminals for the main and auxiliary circuits.
- ⑤ Selector switch for Manual/Automatic RESET:
With the slide switch you can choose between Manual and Automatic RESET.
- ⑥ Motor current setting:
Setting the device to the rated motor current is easy with the large rotary knob.
- ⑦ A device set to Manual RESET can be reset locally by pressing the RESET button. On 3RB31 overload relays an electrical Remote RESET is integrated.
- ⑧ Connection for mounting onto contactors:
Optimally adapted in electrical, mechanical and design terms to the 3RT2 contactors. The overload relay can be connected directly using these connection pins. Stand-alone installation is possible as an alternative (in conjunction with a terminal support for stand-alone installation).

A sealable transparent cover can be optionally mounted (accessory). It secures the motor current setting against adjustment.

SIRIUS 3RB3133-4.B0 electronic overload relay

The 3RB30/3RB31 electronic overload relays up to 115 A with internal power supply have been designed for current-dependent protection of loads with normal and heavy starting, and to protect against excessive temperature rises due to overload, phase asymmetry or phase failure. An overload, phase asymmetry or phase failure result in an increase of the motor current beyond the set rated motor current. This current rise is detected by the current transformers integrated into the devices and evaluated by corresponding solid-state circuits which then output a pulse to the auxiliary contacts. The auxiliary contacts then switch off the load by means of a contactor. The break time depends on the ratio between the tripping current and the current setting I_e and is stored in the form of a long-term stable tripping characteristic curve, see [Characteristics](#).

In addition to inverse-time delayed protection of loads against excessive temperature rises due to overload, phase asymmetry and phase failure, the 3RB31 electronic overload relays also allow internal ground-fault detection (not possible in conjunction with contactor assemblies for star-delta (wye-delta) starting). This provides protection of loads against incomplete ground faults due to damage to the insulation material, moisture, condensed water, etc.

The "tripped" status is signaled by means of a switch position indicator. The relay is reset manually or automatically after the recovery time has elapsed.

The 3RB3 electronic overload relays are suitable for operation with frequency converters.

The devices are manufactured in accordance with environmental guidelines and contain environmentally friendly and reusable materials. They comply with all important worldwide standards and approvals.

For 3RB20 and 3RB21 overload relays in sizes S6 to S10/S12, see [page 7/114 onwards](#).

Use in hazardous areas

The 3RB30/3RB31 electronic overload relays are suitable for the overload protection of motors with the following types of protection:

- II (2) G [Ex e] [Ex d] [Ex px]
- II (2) D [Ex t] [Ex p]

EC type-examination certificate for Group II, Category (2) G/D exists. It has the number PTB 09 ATEX 3001.

Article number scheme

Product versions	Article number
Electronic overload relays	3RB3 □ □ □ - □ □ □ □
Device type	e.g. 0 = standard device, with internal supply, for three-phase loads □ □ □ □
Size, rated operational current and power	e.g. 1 = 16 A (7.5 kW) for size S00 □ □ □ □
Version of the Automatic RESET, electrical Remote RESET	e.g. 6 = switchable between Manual/Automatic RESET □ □ □ □
Trip class (CLASS)	e.g. 1 = CLASS 10E □ □ □ □
Setting range of the overload release	e.g. R = 0.1 ... 0.4 A □ □ □ □
Connection methods	e.g. B = screw terminals for main and auxiliary circuits □ □ □ □
Installation type	e.g. 0 = for mounting onto contactors □ □ □ □
Example	3RB3 0 1 6 - 1 R B 0

Note:

The article number scheme shows an overview of product versions for better understanding of the logic behind the article numbers.

For your orders, please use the article numbers quoted in the selection and ordering data.

Benefits

The most important features and benefits of the 3RB30/3RB31 electronic overload relays are listed in the overview table (see "General Data" page 7/76 onwards.)

Application

Industries

The 3RB30/3RB31 electronic overload relays are suitable for customers from all industries who want to guarantee optimum inverse-time delayed protection of their electrical loads (e.g. motors) under normal and heavy starting conditions (CLASS 5E to 30E), minimize project completion times, inventories and energy consumption, and optimize plant availability and maintenance management.

Application

The 3RB30/3RB31 electronic overload relays have been designed for the protection of three-phase motors in sinusoidal 50/60 Hz voltage networks. The relays are not suitable for the protection of single-phase AC or DC loads.

The 3RU21 thermal overload relay or the 3RB22/3RB23/3RB24 electronic overload relay can be used for single-phase AC loads. For DC loads we recommend the 3RU21 thermal overload relay.

Ambient conditions

The devices are insensitive to external influences such as shocks, corrosive ambient conditions, aging and temperature fluctuations.

For the temperature range from -25 to +60 °C, the 3RB30/3RB31 electronic overload relays compensate the temperature in accordance with IEC 60947-4-1.

Use of SIRIUS protection devices in conjunction with IE3 and IE4 motors

Note:

For the use of 3RB30/3RB31 electronic overload relays in conjunction with highly efficient IE3 and IE4 motors, please observe the information on dimensioning and configuring, see [Application Manual](#).

For more information, see [page 1/8](#).

Protection equipment

Overload relays

SIRIUS 3RB3 electronic overload relays

3RB30, 3RB31 for standard applications



Technical specifications

More information

System Manual for modular system, see
<https://support.industry.siemens.com/cs/ww/en/view/60311318>
 Configuration Manual for load feeders, see
<https://support.industry.siemens.com/cs/ww/en/view/39714188>

Equipment Manual, see
<https://support.industry.siemens.com/cs/ww/en/view/60298164>
 Technical specifications, see
<https://support.industry.siemens.com/cs/ww/en/ps/16276/tid>

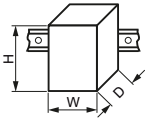
The following technical information is intended to provide an initial overview of the various types of devices and functions.

Type		3RB3016, 3RB3113	3RB3026, 3RB3123	3RB3036, 3RB3133	3RB3046, 3RB3143
Size		S00	S0	S2	S3
Dimensions (W x H x D) (overload relay with stand-alone installation support)					
• Screw terminals	mm	45 x 89 x 80	45 x 97 x 94	55 x 105 x 117	70 x 106 x 124
• Spring-loaded terminals	mm	45 x 102 x 80	45 x 116 x 95	55 x 105 x 117	70 x 106 x 124
General data					
Tripping in the event of		Overload, phase failure, and phase asymmetry + ground fault (for 3RB31 only)			
Trip class according to IEC 60947-4-1	CLASS	3RB30: 10E, 20E; 3RB31: 5E, 10E, 20E or 30E adjustable			
Phase failure sensitivity		Yes			
Reset and recovery		Manual and Automatic RESET, 3RB31 has an integrated connection for electrical Remote RESET (24 V DC)			
• Reset options after tripping					
• Recovery time		Approx. 3 min			
- For Automatic RESET		Immediately			
- For Manual RESET		Immediately			
- For Remote RESET		Immediately			
Features		Yes, by means of switch position indicator slide			
• Display of operating state on device		Yes, test of electronics by pressing the TEST button/ test of auxiliary contacts and wiring of control circuit by actuating the switch position indicator slide/self-monitoring			
• TEST function		Yes			
• RESET button		No			
• STOP button					
Protection and operation of explosion-proof motors		PTB 09 ATEX 3001  II (2) G [Ex e] [Ex d] [Ex px]  II (2) G [Ex t] [Ex p] see https://support.industry.siemens.com/cs/ww/en/view/40591327			
Certificate of suitability/explosion protection type according to ATEX Directive 2014/34/EU					
Ambient temperatures		-40 ... +80			
• Storage/transport	°C	-25 ... +60			
• Operation	°C	+60			
• Temperature compensation	°C				
• Permissible rated current at		100			
- Temperature inside control cabinet 60 °C	%	On request			
- Temperature inside control cabinet 70 °C	%				
Repeat terminals		Yes		Not required	
• Coil repeat terminals		Yes		Not required	
• Auxiliary contact repeat terminals					
Degree of protection IP on the front according to IEC 60529		IP20		IP20	
• Screw terminals/spring-loaded terminals		--		IP20	
• Straight-through transformers					
Touch protection on the front according to IEC 60529		Finger-safe for vertical touching from the front			
• Screw terminals/spring-loaded terminals		--		Finger-safe for vertical touching from the front	
• Straight-through transformers					
Shock resistance with sine according to IEC 60068-2-27	g/ms	15/11 (signaling contact 97/98 in position "tripped": 9 g/11 ms)		15/11 (signaling contact 97/98 in position "tripped": 8 g/11 ms)	

Protection equipment

Overload relays

SIRIUS 3RB3 electronic overload relays

3RB30, 3RB31 for standard applications

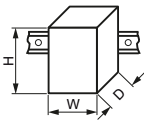



Type		3RB3016, 3RB3113	3RB3026, 3RB3123	3RB3036, 3RB3133	3RB3046, 3RB3143
Size		S00	S0	S2	S3
Dimensions (W x H x D) (overload relay with stand-alone installation support)					
• Screw terminals	mm	45 x 89 x 80	45 x 97 x 94	55 x 105 x 117	70 x 106 x 124
• Spring-loaded terminals	mm	45 x 102 x 80	45 x 116 x 95	55 x 105 x 117	70 x 106 x 124
General data (continued)					
Electromagnetic compatibility (EMC) – Interference immunity					
• Conductor-related interference					
- Burst according to IEC 61000-4-4 (corresponds to degree of severity 3)	kV	2 (power ports), 1 (signal port)			
- Surge according to IEC 61000-4-5 (corresponds to degree of severity 3)	kV	2 (line to earth), 1 (line to line)			
• Electrostatic discharge according to IEC 61000-4-2 (corresponds to degree of severity 3)	kV	8 (air discharge), 6 (contact discharge)			
• Field-related interference according to IEC 61000-4-3 (corresponds to degree of severity 3)	V/m	10			
Electromagnetic compatibility (EMC) – Emitted interference					
Degree of severity B according to EN 55011 (CISPR 11) and EN 55022 (CISPR 22)					
Installation altitude above sea level	m	Up to 2 000			
Mounting position		Any			
Type of mounting		Direct mounting/stand-alone installation with terminal support			
Main circuit					
Rated insulation voltage U_i (pollution degree 3)	V	690		690 1 000 with straight-through transformer	1 000
Rated impulse withstand voltage U_{imp}	kV	6		6 8 with straight-through transformer	8
Rated operational voltage U_e	V	690		690 1 000 with straight-through transformer	1 000
Type of current					
• Direct current		No			
• Alternating current		Yes, 50/60 Hz ±5%			
Current setting	A	0.1 ... 0.4 to 4 ... 16	0.1 ... 0.4 to 10 ... 40	12.5 ... 50 and 20 ... 80	12.5 ... 50 and 32 ... 115
Heavy starting		See Equipment Manual			
Power loss per unit (max.)	W	0.1 ... 1.1	0.1 ... 4.5	0.5 ... 4.6	0.9 ... 4.6
Short-circuit protection					
• With fuse without contactor		See "Selection and ordering data", pages 7/102 ... 7/104			
• With fuse and contactor		"Short-Circuit Protection with Fuses/Motor Starter Protectors for Motor Feeders", see Configuration Manual .			
Protective separation between main and auxiliary conducting paths					
According to IEC 60947-1 (pollution degree 2)					
• For systems with grounded neutral point	V	690			
• For systems with ungrounded neutral point	V	600			

Protection equipment

Overload relays

SIRIUS 3RB3 electronic overload relays

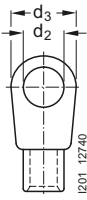
3RB30, 3RB31 for standard applications

Type	3RB3016, 3RB3113	3RB3026, 3RB3123	3RB3036, 3RB3133	3RB3046, 3RB3143
Size	S00	S0	S2	S3
Conductor cross-sections of main circuit				
Connection type	 Screw terminals			 Screw terminals with box terminal
Terminal screw	M3, Pozidriv size 2	M4, Pozidriv size 2		4 mm Allen screw
Operating devices	mm	∅ 5 ... 6	∅ 5 ... 6	4 mm Allen screw
Prescribed tightening torque	Nm	0.8 ... 1.2	2 ... 2.5	4.5 ... 6
Conductor cross-sections (min./max.), one or two conductors can be connected				
• Solid or stranded	mm ²	2 x (0.5 ... 1.5) ¹⁾ , 2 x (0.75 ... 2.5) ¹⁾ , 2 x (0.5 ... 4) ¹⁾	2 x (1 ... 2.5) ¹⁾ , 2 x (2.5 ... 10) ¹⁾	1 x (1 ... 50) ¹⁾ , 2 x (1 ... 35) ¹⁾
• Finely stranded with end sleeve (DIN 46228)	mm ²	2 x (0.5 ... 1.5) ¹⁾ , 2 x (0.75 ... 2.5) ¹⁾	2 x (1 ... 2.5) ¹⁾ , 2 x (2.5 ... 6) ¹⁾ , max. 1 x 10	2 x (1 ... 25) ¹⁾ , 1 x (1 ... 35) ¹⁾
• AWG cables, solid or stranded	AWG	2 x (20 ... 16) ¹⁾ , 2 x (18 ... 14) ¹⁾ , 2 x 12	2 x (16 ... 12) ¹⁾ , 2 x (14 ... 8) ¹⁾	2 x (18 ... 2) ¹⁾ , 1 x (18 ... 1) ¹⁾
Removable box terminals²⁾				
• With copper bars ³⁾	mm	--	--	--
• With cable lugs ⁴⁾				
- Terminal screw		--	--	--
- Prescribed tightening torque	Nm	--	--	--
- Usable ring cable lugs	mm	--	--	--
				2 x 12 x 4
				M6
				4.5 ... 6
				d ₂ = min. 6.3
				d ₃ = max. 19
Connection type				
		 Spring-loaded terminals		
Operating devices	mm	3.0 x 0.5 and 3.5 x 0.5		
Conductor cross-sections (min./max.), one conductor can be connected				
• Solid or stranded	mm ²	1 x (0.5 ... 4)	1 x (1 ... 10)	--
• Finely stranded without end sleeve	mm ²	1 x (0.5 ... 2.5)	1 x (1 ... 6)	--
• Finely stranded with end sleeve (DIN 46228)	mm ²	1 x (0.5 ... 2.5)	1 x (1 ... 6)	--
• AWG cables, solid or stranded	AWG	1 x (20 ... 12)	1 x (18 ... 8)	--
• Max. external diameter of the conductor insulation	mm	3.6	6.4	--
Connection type				
		 Straight-through transformers		
Diameter of opening	mm	--	15	18

¹⁾ If two different conductor cross-sections are connected to one clamping point, both cross-sections must be in the range specified.

²⁾ Cable lug and busbar connection possible after removing the box terminals.

³⁾ If bars larger than 12 mm x 10 mm are connected, a 3RT2946-4EA2 cover is needed to maintain the required phase clearance, [see page 7/106](#).

⁴⁾ If conductors larger than 25 mm² are connected, the 3RT2946-4EA2 cover is needed to maintain the required phase clearance, [see page 7/106](#).



Protection equipment

Overload relays

SIRIUS 3RB3 electronic overload relays

3RB30, 3RB31 for standard applications

Type		3RB3016, 3RB3113	3RB3026, 3RB3123	3RB3036, 3RB3133	3RB3046, 3RB3143
Size		S00	S0	S2	S3
Auxiliary circuit					
Number of NO contacts		1			
Number of NC contacts		1			
Auxiliary contacts – Assignment		1 NO for the signal "tripped"; 1 NC for disconnecting the contactor			
Rated insulation voltage U_i (pollution degree 3)	V	300			
Rated impulse withstand voltage U_{imp}	kV	4			
Auxiliary contacts – Contact rating					
• NC, NO contact with alternating current AC-14/AC-15, rated operational current I_e at U_e					
- 24 V	A	4			
- 120 V	A	4			
- 125 V	A	4			
- 250 V	A	3			
• NC, NO contacts with direct current DC-13, rated operational current I_e at U_e					
- 24 V	A	2			
- 60 V	A	0.55			
- 110 V	A	0.3			
- 125 V	A	0.3			
- 250 V	A	0.11			
• Conventional thermal current I_{th}	A	5			
• Contact reliability (suitability for PLC control; 17 V, 5 mA)		Yes			
Short-circuit protection					
• With fuse, operational class gG	A	6			
Ground-fault protection (only 3RB31)					
• Tripping value I_{Δ}		The information refers to sinusoidal residual currents at 50/60 Hz. > $0.75 \times I_{motor}$			
• Operating range I		Lower current setting < I_{motor} < 3.5 x upper current setting			
• Response time t_{trip} (in steady-state condition)	s	< 1			
Integrated electrical Remote RESET (only 3RB31)					
Connecting terminals A3, A4		24 V DC, max. 200 mA for approx. 20 ms, then < 10 mA			
Protective separation between auxiliary conducting paths according to IEC 60947-1	V	300			

Type		3RB3016, 3RB3113	3RB3026, 3RB3123	3RB3036, 3RB3133	3RB3046, 3RB3143
Size		S00	S0	S2	S3
CSA, UL and UR rated data					
Auxiliary circuit – Switching capacity		B600, R300			
Conductor cross-sections for auxiliary circuit					
Connection type					
 Screw terminals					
Terminal screw		M3, Pozidriv size 2			
Operating devices	mm	∅ 5 ... 6			
Prescribed tightening torque	Nm	0.8 ... 1.2			
Conductor cross-sections (min./max.), one or two conductors can be connected					
• Solid or stranded	mm ²	1 x (0.5 ... 4) ¹⁾ , 2 x (0.5 ... 2.5) ¹⁾			
• Finely stranded with end sleeve (DIN 46228)	mm ²	1 x (0.5 ... 2.5) ¹⁾ , 2 x (0.5 ... 1.5) ¹⁾			
• AWG cables, solid or stranded	AWG	2 x (20 ... 14)			
Connection type					
 Spring-loaded terminals					
Operating devices	mm	3.0 x 0.5			
Conductor cross-sections (min./max.), one or two conductors can be connected					
• Solid or stranded	mm ²	2 x (0.25 ... 1.5)			
• Finely stranded without end sleeve	mm ²	2 x (0.25 ... 1.5)			
• Finely stranded with end sleeve (DIN 46228)	mm ²	2 x (0.25 ... 1.5)			
• AWG cables, solid or stranded	AWG	2 x (24 ... 16)			

¹⁾ If two different conductor cross-sections are connected to one clamping point, both cross-sections must be in the range specified.

Protection equipment

Overload relays

SIRIUS 3RB3 electronic overload relays

3RB30, 3RB31 for standard applications **IE3/IE4 ready**

Selection and ordering data

3RB30 electronic overload relays, CLASS 10E



Features and technical specifications:

- Connection methods
 - Sizes S00 and S0
Main and auxiliary circuit: Either screw or spring-loaded terminals
 - Sizes S2 and S3
Main circuit: Screw terminals with box terminal or as straight-through transformer
Auxiliary circuit: Either screw or spring-loaded terminals
- Overload protection, phase failure protection and asymmetry protection

- Internal power supply
- Auxiliary contacts 1 NO + 1 NC
- Manual and Automatic RESET
- Switch position indicator
- TEST function and self-monitoring
- Sealable covers (optional accessory)

PU (UNIT, SET, M) = 1
PS* = 1 unit
PG = 41G



Size contactor	Rated power for three-phase motors, rated value ¹⁾	Current setting value of the inverse-time delayed overload release	Short-circuit protection with fuse, type of coordination "2", operational class gG ²⁾	Screw terminals 		Spring-loaded terminals 	
	kW	A	A	Article No.	Price per PU	Article No.	Price per PU

Size S00

S00 *Devices for mounting on contactor³⁾*

0.04 ... 0.09	0.1 ... 0.4	4
0.12 ... 0.37	0.32 ... 1.25	6
0.37 ... 1.5	1 ... 4	20
1.5 ... 5.5	3 ... 12	50
2.2 ... 7.5	4 ... 16	50

3RB3016-1RB0
3RB3016-1NB0
3RB3016-1PB0
3RB3016-1SB0
3RB3016-1TB0

3RB3016-1RE0
3RB3016-1NE0
3RB3016-1PE0
3RB3016-1SE0
3RB3016-1TE0

Size S0

S0 *Devices for mounting on contactor³⁾*

0.04 ... 0.09	0.1 ... 0.4	4
0.12 ... 0.37	0.32 ... 1.25	6
0.37 ... 1.5	1 ... 4	20
1.5 ... 5.5	3 ... 12	50
3 ... 11	6 ... 25	63
5.5 ... 18.5	10 ... 40	80

3RB3026-1RB0
3RB3026-1NB0
3RB3026-1PB0
3RB3026-1SB0
3RB3026-1QB0
3RB3026-1VB0

3RB3026-1RE0
3RB3026-1NE0
3RB3026-1PE0
3RB3026-1SE0
3RB3026-1QE0
3RB3026-1VE0

Size S2

S2 *Devices with screw terminals (main current side) and for mounting on contactor³⁾*

7.5 ... 22	12.5 ... 50	200
11 ... 37	20 ... 80	250

3RB3036-1UB0
3RB3036-1WB0

3RB3036-1UD0
3RB3036-1WD0

Devices with straight-through transformer for stand-alone installation

7.5 ... 22	12.5 ... 50	200
11 ... 37	20 ... 80	250

3RB3036-1UW1
3RB3036-1WW1

3RB3036-1UX1
3RB3036-1WX1

Size S3

S3 *Devices with screw terminals (main current side) and for mounting on contactor³⁾*

7.5 ... 22	12.5 ... 50	200
18.5 ... 55	32 ... 115	315

3RB3046-1UB0
3RB3046-1XB0

3RB3046-1UD0
3RB3046-1XD0

Devices with straight-through transformer for stand-alone installation

7.5 ... 22	12.5 ... 50	200
18.5 ... 55	32 ... 115	315

3RB3046-1UW1
3RB3046-1XW1

3RB3046-1UX1
3RB3046-1XX1

¹⁾ Guide value for 4-pole standard motors at 50 Hz 400 V AC. The actual starting and rated data of the motor to be protected must be considered when selecting the units.

²⁾ Maximum protection by fuse only for overload relays, type of coordination "2". For fuse values in connection with contactors, see Configuration Manual.

³⁾ With the appropriate terminal supports (see page 7/105), these overload relays can also be installed as stand-alone units.

Note:

For reliable operational current, note derating information, see Equipment Manual.

Protection equipment

Overload relays

SIRIUS 3RB3 electronic overload relays

IE3/IE4 ready 3RB30, 3RB31 for standard applications

3RB30 electronic overload relays, CLASS 20E

Features and technical specifications:

- Connection methods
 - Sizes S00 and S0
Main and auxiliary circuit: Either screw or spring-loaded terminals
 - Sizes S2 and S3
Main circuit: Screw terminals with box terminal or as straight-through transformer
Auxiliary circuit: Either screw or spring-loaded terminals
- Overload protection, phase failure protection and asymmetry protection
- Internal power supply

- Auxiliary contacts 1 NO + 1 NC
- Manual and Automatic RESET
- Switch position indicator
- TEST function and self-monitoring
- Sealable covers (optional accessory)

 PU (UNIT, SET, M) = 1
 PS* = 1 unit
 PG = 41G

3RB3016-2.B0



3RB3026-2.B0

3RB3036-2.B0

3RB3036-2.W1

3RB3046-2.B0

3RB3046-2.W1

Size	Rated power for three-phase motors, rated value ¹⁾	Current setting value of the inverse-time delayed overload release	Short-circuit protection with fuse, type of coordination "2", operational class gG ²⁾	Screw terminals 	Spring-loaded terminals 
	kW	A	A	Article No.	Price per PU

Size S00

S00 *Devices for mounting on contactor³⁾*

0.04 ... 0.09	0.1 ... 0.4	4
0.12 ... 0.37	0.32 ... 1.25	6
0.37 ... 1.5	1 ... 4	20
1.5 ... 5.5	3 ... 12	50
2.2 ... 7.5	4 ... 16	50

3RB3016-2RB0
3RB3016-2NB0
3RB3016-2PB0
3RB3016-2SB0
3RB3016-2TB0

3RB3016-2RE0
3RB3016-2NE0
3RB3016-2PE0
3RB3016-2SE0
3RB3016-2TE0

Size S0

S0 *Devices for mounting on contactor³⁾*

0.04 ... 0.09	0.1 ... 0.4	4
0.12 ... 0.37	0.32 ... 1.25	6
0.37 ... 1.5	1 ... 4	20
1.5 ... 5.5	3 ... 12	50
3 ... 11	6 ... 25	63
5.5 ... 18.5	10 ... 40	80

3RB3026-2RB0
3RB3026-2NB0
3RB3026-2PB0
3RB3026-2SB0
3RB3026-2QB0
3RB3026-2VB0

3RB3026-2RE0
3RB3026-2NE0
3RB3026-2PE0
3RB3026-2SE0
3RB3026-2QE0
3RB3026-2VE0

Size S2

S2 *Devices with screw terminals (main current side) and for mounting on contactor³⁾*

7.5 ... 22	12.5 ... 50	200
11 ... 37	20 ... 80	250

3RB3036-2UB0
3RB3036-2WB0

3RB3036-2UD0
3RB3036-2WD0

Devices with straight-through transformer for stand-alone installation

7.5 ... 22	12.5 ... 50	200
11 ... 37	20 ... 80	250

3RB3036-2UW1
3RB3036-2WW1

3RB3036-2UX1
3RB3036-2WX1

Size S3

S3 *Devices with screw terminals (main current side) and for mounting on contactor³⁾*

7.5 ... 22	12.5 ... 50	200
18.5 ... 55	32 ... 115	315

3RB3046-2UB0
3RB3046-2XB0

3RB3046-2UD0
3RB3046-2XD0

Devices with straight-through transformer for stand-alone installation

7.5 ... 22	12.5 ... 50	200
18.5 ... 55	32 ... 115	315

3RB3046-2UW1
3RB3046-2XW1

3RB3046-2UX1
3RB3046-2XX1

¹⁾ Guide value for 4-pole standard motors at 50 Hz 400 V AC. The actual starting and rated data of the motor to be protected must be considered when selecting the units.

²⁾ Maximum protection by fuse only for overload relays, type of coordination "2". For fuse values in connection with contactors, see [Configuration Manual](#).

³⁾ With the appropriate terminal supports (see page 7/105), these overload relays can also be installed as stand-alone units.

Protection equipment

Overload relays

SIRIUS 3RB3 electronic overload relays

3RB30, 3RB31 for standard applications **IE3/IE4 ready**

3RB31 electronic overload relays, CLASS 5E, 10E, 20E or 30E (adjustable)

Features and technical specifications:

- Connection methods
 - Sizes S00 and S0
Main and auxiliary circuit: Either screw or spring-loaded terminals
 - Sizes S2 and S3
Main circuit: Screw terminals with box terminal or as straight-through transformer
Auxiliary circuit: Either screw or spring-loaded terminals
- Overload protection, phase failure protection and asymmetry protection
- Internal ground-fault detection (activatable)
- Internal power supply
- Auxiliary contacts 1 NO + 1 NC
- Manual and Automatic RESET
- Electrical Remote RESET integrated
- Switch position indicator
- TEST function and self-monitoring
- Sealable covers (optional accessory)

PU (UNIT, SET, M) = 1
PS* = 1 unit
PG = 41G



3RB3113-4.B0



3RB3123-4.B0

3RB3133-4.B0

3RB3133-4.W1

3RB3143-4.B0

3RB3143-4.W1

Size contactor	Rated power for three-phase motors, rated value ¹⁾	Current setting value of the inverse-time delayed overload release	Short-circuit protection with fuse, type of coordination "2", operational class gG ²⁾	Screw terminals 	Spring-loaded terminals 
	kW	A	A	Article No.	Price per PU

Size S00

S00 **Devices for mounting on contactor³⁾**

0.04 ... 0.09	0.1 ... 0.4	4
0.12 ... 0.37	0.32 ... 1.25	6
0.37 ... 1.5	1 ... 4	20
1.5 ... 5.5	3 ... 12	50
2.2 ... 7.5	4 ... 16	50

3RB3113-4RB0
3RB3113-4NB0
3RB3113-4PB0
3RB3113-4SB0
3RB3113-4TB0

3RB3113-4RE0
3RB3113-4NE0
3RB3113-4PE0
3RB3113-4SE0
3RB3113-4TE0

Size S0

S0 **Devices for mounting on contactor³⁾**

0.04 ... 0.09	0.1 ... 0.4	4
0.12 ... 0.37	0.32 ... 1.25	6
0.37 ... 1.5	1 ... 4	20
1.5 ... 5.5	3 ... 12	50
3 ... 11	6 ... 25	63
5.5 ... 18.5	10 ... 40	80

3RB3123-4RB0
3RB3123-4NB0
3RB3123-4PB0
3RB3123-4SB0
3RB3123-4QB0
3RB3123-4VB0

3RB3123-4RE0
3RB3123-4NE0
3RB3123-4PE0
3RB3123-4SE0
3RB3123-4QE0
3RB3123-4VE0

Size S2

S2 **Devices with screw terminals (main current side) and for mounting on contactor³⁾**

7.5 ... 22	12.5 ... 50	200
11 ... 37	20 ... 80	250

3RB3133-4UB0
3RB3133-4WB0

3RB3133-4UD0
3RB3133-4WD0

Devices with straight-through transformer for stand-alone installation

7.5 ... 22	12.5 ... 50	200
11 ... 37	20 ... 80	250

3RB3133-4UW1
3RB3133-4WW1

3RB3133-4UX1
3RB3133-4WX1

Size S3

S3 **Devices with screw terminals (main current side) and for mounting on contactor³⁾**

7.5 ... 22	12.5 ... 50	200
18.5 ... 55	32 ... 115	315

3RB3143-4UB0
3RB3143-4XB0

3RB3143-4UD0
3RB3143-4XD0

Devices with straight-through transformer for stand-alone installation

7.5 ... 22	12.5 ... 50	200
18.5 ... 55	32 ... 115	315

3RB3143-4UW1
3RB3143-4XW1

3RB3143-4UX1
3RB3143-4XX1

¹⁾ Guide value for 4-pole standard motors at 50 Hz 400 V AC. The actual starting and rated data of the motor to be protected must be considered when selecting the units.

²⁾ Maximum protection by fuse only for overload relays, type of coordination "2". For fuse values in connection with contactors, see Configuration Manual.











³⁾ With the appropriate terminal supports (see page 7/105), these overload relays can also be installed as stand-alone units.

Overview

The following optional accessories are available for the 3RB30/3RB31 electronic overload relays:

- Size-specific terminal support for stand-alone installation, in sizes S00 and S0 also with spring-loaded terminals
- Mechanical RESET (for all sizes)
- Cable release for resetting devices which are difficult to access (for all sizes)
- Sealable cover (for all sizes)
- Size-specific terminal covers for devices with screw terminals (box terminals)

Selection and ordering data







Version	Size	Article No.	Price per PU	PU (UNIT, SET, M)	PS*	PG
Terminal supports for stand-alone installation						
Terminal supports for overload relays with screw terminals		Screw terminals 				
	3RU2916-3AA01	For separate mounting of the overload relays; screw and snap-on mounting on DIN rail	S00	3RU2916-3AA01	1	1 unit 41F
	3RU2916-3AC01		S0	3RU2926-3AA01	1	1 unit 41F
			S2	3RU2936-3AA01	1	1 unit 41F
			S3	3RU2946-3AA01	1	1 unit 41F
Terminal supports for overload relays with spring-loaded terminals		Spring-loaded terminals 				
	3RU2926-3AA01	For separate mounting of the overload relays; screw and snap-on mounting on DIN rail	S00	3RU2916-3AC01	1	1 unit 41F
	3RU2926-3AC01		S0	3RU2926-3AC01	1	1 unit 41F
	3RU2936-3AA01					
	3RU2946-3AA01					
Mechanical RESET						
	3RB3980-0A	Resetting plungers, holders and formers	S00 ... S3	3RB3980-0A	1	1 unit 41F
	3SU1200-0FB10-0AA0	Pushbuttons with extended stroke (12 mm), IP65, ø 22 mm	S00 ... S3	3SU1200-0FB10-0AA0	1	1 unit 41J
	3SU1900-0KG10-0AA0	Extension plungers For compensation of the distance between the pushbutton and the resetting plunger of the relay	S00 ... S3	3SU1900-0KG10-0AA0	1	1 unit 41J

Protection equipment

Overload relays

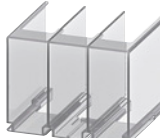
SIRIUS 3RB3 electronic overload relays

Accessories

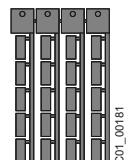
Version	Size	Article No.	Price per PU	PU (UNIT, SET, M)	PS*	PG		
Cable releases with holder for RESET								
 3RB3980-0B	For \varnothing 6.5 mm holes in the control panel; max. control panel thickness 8 mm							
	<ul style="list-style-type: none"> Length 400 mm Length 600 mm 	S00 ... S3	3RB3980-0B 3RB3980-0C	1	1 unit	41F		
				1	1 unit	41F		
Sealable covers								
 3RB3984-0	For covering the setting knobs	S00 ... S3		1	1 unit	41F		
Terminal covers								
 3RT1946-4EA1	Covers for contactors with cable lug and busbar connections For complying with the phase clearances and as touch protection if box terminal is removed	S3		1	1 unit	41B		
	 3RT2936-4EA2	Covers for devices with screw terminals (box terminals) Additional touch protection for fastening to the box terminals	S2		1	1 unit	41B	
		<ul style="list-style-type: none"> Main current level 	S3	Screw terminals  3RT2936-4EA2 3RT2946-4EA2	1	1 unit	41B	
				1	1 unit	41B		
General accessories								
Version	Size	Color	For overload relays	Article No.	Price per PU	PU (UNIT, SET, M)	PS*	PG
Tools for opening spring-loaded terminals								
 3RA2908-1A	Screwdrivers For all SIRIUS devices with spring-loaded terminals	Length approx. 200 mm, 3.0 mm x 0.5 mm	Titanium gray/black, partially insulated	Main and auxiliary circuit connection: 3RB3				
					Spring-loaded terminals  3RA2908-1A	1	1 unit	41B
Blank labels								
 3RT2900-1SB20	Unit labeling plates¹⁾ For SIRIUS devices	20 mm x 7 mm	Titanium gray	3RB3		100	340 units	41B
	Adhesive labels For SIRIUS devices	19 mm x 6 mm	Titanium gray	3RB2		100	3 060 units	41B
				3RT2900-1SB60				

¹⁾ PC labeling system for individual inscription of unit labeling plates available from: murrplastik Systemtechnik GmbH (see page 16/18).

Overview

More information

Homepage, see www.siemens.com/sirius-control
 Industry Mall, see www.siemens.com/product?3RB2
 Conversion tool, see www.siemens.com/conversion-tool

Application Manual for switching devices with IE3 and IE4 motors, see <https://support.industry.siemens.com/cs/ww/en/view/94770820>
 Equipment Manual, see <https://support.industry.siemens.com/cs/ww/en/view/60298164>
 Characteristics and certificates, see <https://support.industry.siemens.com/cs/ww/en/ps/16278>

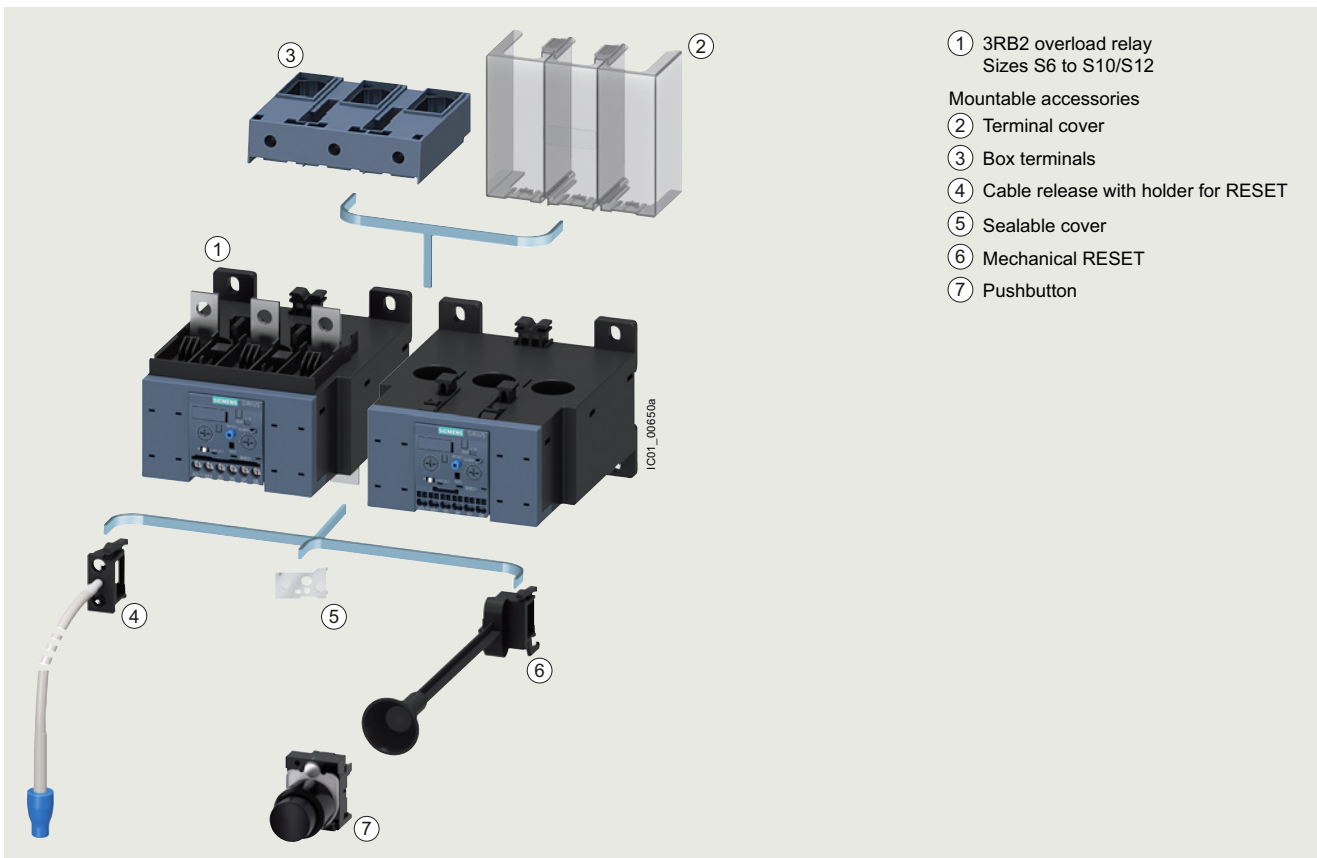

Mountable accessories for 3RB2 electronic overload relays (sizes S6 to S10/S12)

Protection equipment

Overload relays

SIRIUS 3RB2 electronic overload relays

3RB20, 3RB21 for standard applications

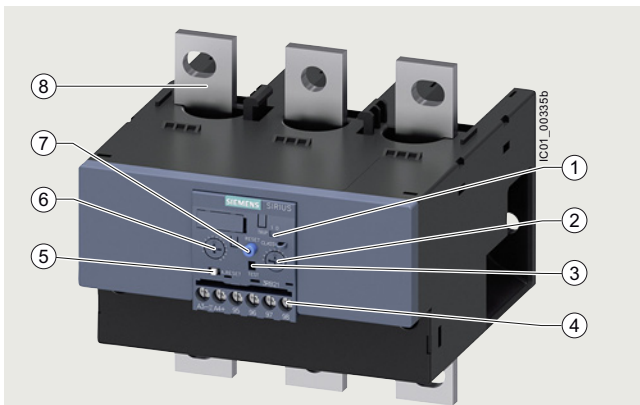

- ① Switch position indicator and TEST function of the wiring:
Indicates a trip and enables the wiring test.
- ② Trip class setting/internal ground-fault detection (only 3RB21):
Using the rotary switch you can set the required trip class and activate the internal ground-fault detection dependent on the starting conditions.
- ③ Solid-state test (device test):
Enables a test of all important device components and functions.
- ④ Connecting terminals (removable terminal block for auxiliary circuits):
The generously sized terminals permit connection of two conductors with different cross-sections for the main and auxiliary circuits. The auxiliary circuit can be connected with screw terminals and alternatively with spring-loaded terminals.
- ⑤ Selector switch for Manual/Automatic RESET:
With the slide switch you can choose between Manual and Automatic RESET.
- ⑥ Motor current setting:
Setting the device to the rated motor current is easy with the large rotary knob.
- ⑦ A device set to Manual RESET can be reset locally by pressing the RESET button. On the 3RB21 overload relay a solid-state Remote RESET is integrated.
- ⑧ Connection for mounting onto contactors:
Optimally adapted in electrical, mechanical and design terms to the 3RT1 contactors. These connecting pins can be used for direct mounting of the overload relay to the contactor. Stand-alone installation is possible as an alternative (partly in conjunction with a terminal support for stand-alone installation).

SIRIUS 3RB2153-4FW2 electronic overload relays

The 3RB20 and 3RB21 electronic overload relays up to 630 A with internal power supply have been designed for inverse-time delayed protection of loads with normal and heavy starting (see [Equipment Manual](#)) against excessive temperature rises due to overload, phase asymmetry or phase failure.

An overload, phase asymmetry or phase failure result in an increase of the motor current beyond the set rated motor current. This current rise is detected by the current transformers integrated into the devices and evaluated by corresponding solid-state circuits which then output a pulse to the auxiliary contacts. The auxiliary contacts then switch off the load by means of a contactor. The break time depends on the ratio between the tripping current and the current setting I_e and is stored in the form of a long-term stable tripping characteristic curve, see [Characteristics](#).

In addition to inverse-time delayed protection of loads against excessive temperature rises due to overload, phase asymmetry and phase failure, the 3RB21 electronic overload relays also allow internal ground-fault detection (not possible in conjunction with contactor assemblies for star-delta (wye-delta) starting). This provides protection of loads against incomplete ground faults due to damage to the insulation material, moisture, condensed water, etc.

The "tripped" status is signaled by means of a switch position indicator. The relay is reset manually or automatically after the recovery time has elapsed.

The 3RB2 electronic overload relays are suitable for operation with frequency converters, see [Equipment Manual](#).

The devices are manufactured in accordance with environmental guidelines and contain environmentally friendly and reusable materials. They comply with all important worldwide standards and approvals.

For 3RB30 and 3RB31 overload relays sizes S00 to S3, see [page 7/102 onwards](#).

Use in hazardous areas

The 3RB20/3RB21 electronic overload relays are suitable for the overload protection of motors with the following types of protection:

- II (2) G [Ex e] [Ex d] [Ex px]
- II (2) D [Ex t] [Ex p]

EC type-examination certificate for Group II, Category (2) G/D exists. It has the number PTB 06 ATEX 3001.

Article number scheme

Product versions	Article number
Electronic overload relays	3RB2 □ □ □ - □ □ □ □
Device type	e.g. 0 = standard device, with internal supply, for three-phase loads □ □ □ □
Size, rated operational current and power	e.g. 5 = 200 A (90 kW) for size S6 □ □ □ □
Version of the Automatic RESET, electrical Remote RESET	e.g. 6 = switchable between Manual/Automatic RESET □ □ □ □
Trip class (CLASS)	e.g. 1 = CLASS 10E □ □ □ □
Setting range of the overload release	e.g. F = 5 ... 200 A □ □ □ □
Connection methods	e.g. C = busbar connections main circuit; screw terminals auxiliary circuit □ □ □ □
Installation type	e.g. 2 = mounting on contactor and stand-alone installation □ □ □ □
Example	3RB2 0 5 6 - 1 F C 2

Note:

The article number scheme shows an overview of product versions for better understanding of the logic behind the article numbers.

For your orders, please use the article numbers quoted in the selection and ordering data.

Benefits

The most important features and benefits of the 3RB20/3RB21 electronic overload relays are listed in the overview table (see "General data", page 7/76 onwards).

Application

Industries

The 3RB20 and 3RB21 electronic overload relays are suitable for customers from all industries who want to guarantee optimum inverse-time delayed protection of their electrical loads (e.g. motors) under normal and heavy starting conditions (CLASS 5E to 30E), minimize project completion times, inventories and energy consumption, and optimize plant availability and maintenance management.

Application

The 3RB20 and 3RB21 electronic overload relays have been designed for the protection of three-phase motors in sinusoidal 50/60 Hz voltage networks. The relays are not suitable for the protection of single-phase AC or DC loads.

The 3RU21 thermal overload relays or the 3RB22 to 3RB24 electronic overload relays can be used for single-phase AC loads. For DC loads we recommend the 3RU21 thermal overload relay.

Ambient conditions

The devices are insensitive to external influences such as shocks, corrosive ambient conditions, aging and temperature fluctuations.

For the temperature range from -25 to +60 °C, the 3RB20 and 3RB21 electronic overload relays compensate the temperature in accordance with IEC 60947-4-1.

For the 3RB20 and 3RB21 electronic overload relays with the sizes S6, S10 and S12, the upper set value of the setting range must be reduced for ambient temperatures > 50 °C by a certain factor.

Use of SIRIUS protection devices in conjunction with IE3 and IE4 motors

Note:

For the use of 3RB20 and 3RB21 electronic overload relays in conjunction with highly efficient IE3 and IE4 motors, please observe the information on dimensioning and configuring, see [Application Manual](#).

For more information, see [page 1/8](#).

Protection equipment

Overload relays

SIRIUS 3RB2 electronic overload relays

3RB20, 3RB21 for standard applications



Technical specifications

More information

Configuration Manual for load feeders, see
<https://support.industry.siemens.com/cs/ww/en/view/39714188>
 Equipment Manual, see
<https://support.industry.siemens.com/cs/ww/en/view/60298164>

Technical specifications, see
<https://support.industry.siemens.com/cs/ww/en/ps/16278/td>

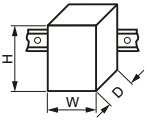
The following technical information is intended to provide an initial overview of the various types of devices and functions.

Type		3RB2056, 3RB2153	3RB2066, 3RB2163
Size		S6	S10/S12
Dimensions (W x H x D) (overload relay with stand-alone installation support)		120 x 119 x 155	145 x 147 x 156
General data			
Tripping in the event of		Overload, phase failure, and phase asymmetry + ground fault (for 3RB21 only)	
Trip class according to IEC 60947-4-1	CLASS	3RB20: 10E or 20E; 3RB21: 5E, 10E, 20E and 30E adjustable	
Phase failure sensitivity		Yes	
Overload warning		No	
Reset and recovery		3RB20: Manual and Automatic RESET; 3RB21: Manual, Automatic and Remote RESET	
• Reset options after tripping			
• Recovery time		Approx. 3 min	
- For Automatic RESET		Immediately	
- For Manual RESET		Immediately	
- For Remote RESET		Immediately	
Features		Yes, by means of switch position indicator slide	
• Display of operating state on device		Yes, test of electronics by pressing the TEST button/ test of auxiliary contacts and wiring of control circuit by actuating the switch position indicator slide/self-monitoring	
• TEST function		Yes	
• RESET button		No	
• STOP button			
Protection and operation of explosion-proof motors		PTB 06 ATEX 3001  II (2) G [Ex e] [Ex d] [Ex px]  II (2) G [Ex t] [Ex p] See https://support.industry.siemens.com/cs/ww/en/view/23814648	
Certificate of suitability/explosion protection type according to ATEX Directive 2014/34/EU			
Ambient temperatures			
• Storage/transport	°C	-40 ... +80	
• Operation	°C	-25 ... +60	
• Temperature compensation	°C	+60	
• Permissible rated current at			
- Temperature inside control cabinet 60 °C, stand-alone installation	%	100	100 or 90 ¹⁾
- Temperature inside control cabinet 60 °C, mounted on contactor	%	70	70
- Temperature inside control cabinet 70 °C	%	On request	
Degree of protection IP on the front according to IEC 60529		IP00 (IP20 with box terminal/cover)	
• Screw terminals/busbar connections		IP20	
• Straight-through transformers		--	
Touch protection on the front according to IEC 60529		Finger-safe for vertical touching from the front (with box terminals/cover)	
• Screw terminals/busbar connections		Finger-safe for vertical touching from the front	
• Straight-through transformers		--	

¹⁾ 90% for relay with current setting range 160 A to 630 A.

Protection equipment

Overload relays

SIRIUS 3RB2 electronic overload relays

3RB20, 3RB21 for standard applications

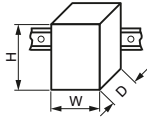

Type		
Size		
Dimensions (W x H x D) (overload relay with stand-alone installation support)		
	mm	
	3RB2056, 3RB2153	3RB2066, 3RB2163
	S6 120 x 119 x 155	S10/S12 145 x 147 x 156
General data (continued)		
Shock resistance with sine according to IEC 60068-2-27	g/ms	15/11 (signaling contact 97/98 in position "tripped": 4 g/11 ms)
Electromagnetic compatibility (EMC) – Interference immunity		
• Conductor-related interference		
- Burst according to IEC 61000-4-4 (corresponds to degree of severity 3)	kV	2 (power ports), 1 (signal port)
- Surge according to IEC 61000-4-5 (corresponds to degree of severity 3)	kV	2 (line to earth), 1 (line to line)
• Electrostatic discharge according to IEC 61000-4-2 (corresponds to degree of severity 3)	kV	8 (air discharge), 6 (contact discharge)
• Field-related interference according to IEC 61000-4-3 (corresponds to degree of severity 3)	V/m	10
Electromagnetic compatibility (EMC) – Emitted interference		Degree of severity B according to EN 55011 (CISPR 11) and EN 55022 (CISPR 22)
Installation altitude above sea level	m	Up to 2 000
Mounting position		Any
Type of mounting		Direct mounting/stand-alone installation

Protection equipment

Overload relays

SIRIUS 3RB2 electronic overload relays

3RB20, 3RB21 for standard applications

Type		3RB2056, 3RB2153	3RB2066, 3RB2163
Size		S6	S10/S12
Main circuit			
Rated insulation voltage U_i (pollution degree 3)	V	1 000	
Rated impulse withstand voltage U_{imp}	kV	8	
Rated operational voltage U_e	V	1 000	
Type of current			
• Direct current		No	
• Alternating current		Yes, 50/60 Hz $\pm 5\%$	
Current setting	A	50 ... 200	55 ... 250, 160 ... 630
Power loss per unit (max.)	W	0.05	
Short-circuit protection		See "Selection and ordering data", pages 7/114 ... 7/116 "Short-Circuit Protection with Fuses/Motor Starter Protectors for Motor Feeders", see Configuration Manual.	
Protective separation between main and auxiliary conducting paths According to IEC 60947-1 (pollution degree 2)			
• For systems with grounded neutral point	V	690	
• For systems with ungrounded neutral point	V	600	
Conductor cross-sections of the main circuit			
Connection type		 Screw terminals with box terminal	
Terminal screw	mm	4 mm Allen screw	5 mm Allen screw
Operating devices	mm	4 mm Allen screw	5 mm Allen screw
Prescribed tightening torque	Nm	10 ... 12	20 ... 22
Conductor cross-sections (min./max.), one or two conductors can be connected			
• Solid	mm ²	--	--
• Finely stranded without end sleeve	mm ²	With 3RT1955-4G box terminal: 2 x (1 x max. 50, 1 x max. 70), 1 x (10 ... 70); With 3RT1956-4G box terminal: 2 x (1 x max. 95, 1 x max. 120), 1 x (10 ... 120)	2 x (50 ... 185), Front clamping point only: 1 x (70 ... 240); Rear clamping point only: 1 x (120 ... 185)
• Finely stranded with end sleeve (DIN 46228)	mm ²	With 3RT1955-4G box terminal: 2 x (1 x max. 50, 1 x max. 70), 1 x (10 ... 70); With 3RT1956-4G box terminal: 2 x (1 x max. 95, 1 x max. 120), 1 x (10 ... 120)	2 x (50 ... 185), Front clamping point only: 1 x (70 ... 240); Rear clamping point only: 1 x (120 ... 185)
• Stranded	mm ²	With 3RT1955-4G box terminal: 2 x (max. 70), 1 x (16 ... 70); With 3RT1956-4G box terminal: 2 x (max. 120), 1 x (16 ... 120)	2 x (70 ... 240), Front clamping point only: 1 x (95 ... 300); Rear clamping point only: 1 x (120 ... 240)
• AWG cables, solid or stranded	AWG	With 3RT1955-4G box terminal: 2 x (max. 1/0), 1 x (6 ... 2/0); With 3RT1956-4G box terminal: 2 x (max. 3/0), 1 x (6 ... 250 kcmil)	2 x (2/0 ... 500 kcmil), Front clamping point only: 1 x (3/0 ... 600 kcmil); Rear clamping point only: 1 x (250 kcmil ... 500 kcmil)
• Ribbon cables (number x width x thickness)	mm	With 3RT1955-4G box terminal: 2 x (6 x 15.5 x 0.8), 1 x (3 x 9 x 0.8 ... 6 x 15.5 x 0.8); With 3RT1956-4G box terminal: 2 x (10 x 15.5 x 0.8), 1 x (3 x 9 x 0.8 ... 10 x 15.5 x 0.8)	2 x (20 x 24 x 0.5), 1 x (6 x 9 x 0.8 ... 20 x 24 x 0.5)
Connection type		 Busbar connections	
Terminal screw		M8 x 25	M10 x 30
Prescribed tightening torque	Nm	10 ... 14	14 ... 24
Conductor cross-sections (min./max.)			
• Finely stranded with cable lug	mm ²	16 ... 95 ¹⁾	50 ... 240 ²⁾
• Stranded with cable lug	mm ²	25 ... 120 ¹⁾	70 ... 240 ²⁾
• AWG cables, solid or stranded, with cable lug	AWG	4 ... 250 kcmil	2/0 ... 500 kcmil
• With connecting bars (max. width)	mm	15	25
Connection type		 Straight-through transformers	
Diameter of opening	mm	24.5	--

¹⁾ When connecting cable lugs according to DIN 46235 with conductor cross-sections from 95 mm², the 3RT1956-4EA1 terminal cover must be used to ensure phase clearance, see page 7/117.



²⁾ When connecting cable lugs according to DIN 46234 for conductor cross-sections from 240 mm², as well as DIN 46235 for cable cross-sections from 185 mm², the 3RT1956-4EA1 terminal cover must be used to ensure phase clearance, see page 7/117.

Protection equipment

Overload relays

SIRIUS 3RB2 electronic overload relays

3RB20, 3RB21 for standard applications

Type	3RB2056, 3RB2153		3RB2066, 3RB2163	
Size	S6		S10/S12	
Auxiliary circuit				
Number of NO contacts	1			
Number of NC contacts	1			
Auxiliary contacts – Assignment	1 NO for the signal "tripped"; 1 NC for disconnecting the contactor			
Rated insulation voltage U_i (pollution degree 3)	V	300		
Rated impulse withstand voltage U_{imp}	kV	4		
Auxiliary contacts – Contact rating				
• NC contact with alternating current AC-14/AC-15, rated operational current I_e at U_e :				
- 24 V	A	4		
- 120 V	A	4		
- 125 V	A	4		
- 250 V	A	3		
• NO contact with alternating current AC-14/AC-15, rated operational current I_e at U_e :				
- 24 V	A	4		
- 120 V	A	4		
- 125 V	A	4		
- 250 V	A	3		
• NC, NO contacts with direct current DC-13, rated operational current I_e at U_e :				
- 24 V	A	2		
- 60 V	A	0.55		
- 110 V	A	0.3		
- 125 V	A	0.3		
- 250 V	A	0.11		
• Conventional thermal current I_{th}	A	5		
• Contact reliability (suitability for PLC control; 17 V, 5 mA)		Yes		
Short-circuit protection				
• With fuse, operational class gG	A	6		
Ground-fault protection (only 3RB21)				
• Tripping value I_{Δ}		The information refers to sinusoidal residual currents at 50/60 Hz. > $0.75 \times I_{motor}$		
• Operating range I		Lower current setting < I_{motor} < $3.5 \times$ upper current setting		
• Response time t_{trip} (in steady-state condition)	s	< 1		
Integrated electrical Remote RESET (only 3RB21)				
Connecting terminals A3, A4		24 V DC, 100 mA, 2.4 W short-term		
Protective separation between auxiliary conducting paths According to IEC 60947-1	V	300		
CSA, UL and UR rated data				
Auxiliary circuit – Switching capacity				
		B300, R300		
Conductor cross-sections of the auxiliary circuit				
Connection type				
		 Screw terminals		
Terminal screw				
		M3, Pozidriv size 2		
Operating devices				
	mm	Ø 5 ... 6		
Prescribed tightening torque				
	Nm	0.8 ... 1.2		
Conductor cross-sections (min./max.), one or two conductors can be connected				
• Solid and stranded	mm ²	1 x (0.5 ... 4) ¹⁾ , 2 x (0.5 ... 2.5) ¹⁾		
• Finely stranded without end sleeve	mm ²	--		
• Finely stranded with end sleeve (DIN 46228)	mm ²	1 x (0.5 ... 2.5) ¹⁾ , 2 x (0.5 ... 1.5) ¹⁾		
• AWG cables, solid or stranded	AWG	2 x (20 ... 14)		
Connection type				
		 Spring-loaded terminals		
Operating devices				
	mm	3.0 x 0.5		
Conductor cross-sections (min./max.), one or two conductors can be connected				
• Solid and stranded	mm ²	2 x (0.25 ... 1.5)		
• Finely stranded without end sleeve	mm ²	--		
• Finely stranded with end sleeve (DIN 46228)	mm ²	2 x (0.25 ... 1.5)		
• AWG cables, solid or stranded	AWG	2 x (24 ... 16)		

¹⁾ If two different conductor cross-sections are connected to one clamping point, both cross-sections must be in the range specified.

Protection equipment

Overload relays

SIRIUS 3RB2 electronic overload relays

3RB20, 3RB21 for standard applications **IE3/IE4 ready**

Selection and ordering data

3RB20 electronic overload relays for mounting on contactors and stand-alone installation, CLASS 10E

Features and technical specifications:

- Connection methods
 - Size S6
Main circuit: With busbar connection or as straight-through transformer (an appropriate connection kit with screws, spring washers and nuts is enclosed with the devices with busbar connection)
Auxiliary circuit: Either screw or spring-loaded terminals
 - Sizes S10/S12
Main circuit: With busbar connection (an appropriate connection kit with screws, spring washers and nuts is enclosed)
Auxiliary circuit: Either screw or spring-loaded terminals
 - Overload protection, phase failure protection and asymmetry protection
 - Internal power supply
 - Auxiliary contacts 1 NO + 1 NC
 - Manual and Automatic RESET
 - Switch position indicator
 - TEST function and self-monitoring
- PU (UNIT, SET, M) = 1
PS* = 1 unit
PG = 41G



3RB2056-1FW2



3RB2066-1MF2

Size contactor	Rated power for three-phase motors, rated value ¹⁾	Current setting value of the inverse-time delayed overload release	Short-circuit protection with fuse, type of coordination "2", operational class gG ²⁾	Screw terminals (on auxiliary current side)	Spring-loaded terminals (on auxiliary current side)
	kW	A	A	Article No. Price per PU	Article No. Price per PU

Size S6

Devices with busbar connection, for mounting onto contactor and stand-alone installation

S6	30 ... 90	50 ... 200	315	3RB2056-1FC2	3RB2056-1FF2
----	-----------	------------	-----	---------------------	---------------------

Devices with straight-through transformer, for mounting on contactor and stand-alone installation

For mounting on S6 contactors with box terminals	30 ... 90	50 ... 200	315	3RB2056-1FW2	3RB2056-1FX2
--	-----------	------------	-----	---------------------	---------------------

Size S10/S12

Devices with busbar connection, for mounting onto contactor and stand-alone installation

S10/S12 and size 14 (3TF68/3TF69) ³⁾	30 ... 132	55 ... 250	400	3RB2066-1GC2	3RB2066-1GF2
	90 ... 355	160 ... 630	800	3RB2066-1MC2	3RB2066-1MF2

¹⁾ Guide value for 4-pole standard motors at 50 Hz 400 V AC. The actual starting and rated data of the motor to be protected must be considered when selecting the units.

²⁾ Maximum protection by fuse only for overload relays, type of coordination "2". For fuse values in connection with contactors, see [Configuration Manual](#).

³⁾ For 3TF68/3TF69 contactors, direct mounting is not possible.

Protection equipment

Overload relays

SIRIUS 3RB2 electronic overload relays

IE3/IE4 ready 3RB20, 3RB21 for standard applications

3RB20 electronic overload relays for mounting on contactors and stand-alone installation, CLASS 20E

Features and technical specifications:

- Connection methods
 - Size S6
Main circuit: With busbar connection or as straight-through transformer (an appropriate connection kit with screws, spring washers and nuts is enclosed with the devices with busbar connection)
Auxiliary circuit: Either screw or spring-loaded terminals
 - Sizes S10/S12
Main circuit: With busbar connection (an appropriate connection kit with screws, spring washers and nuts is enclosed)
Auxiliary circuit: Either screw or spring-loaded terminals
 - Overload protection, phase failure protection and asymmetry protection
 - Internal power supply
 - Auxiliary contacts 1 NO + 1 NC
 - Manual and Automatic RESET
 - Switch position indicator
 - TEST function and self-monitoring
- PU (UNIT, SET, M) = 1
 PS* = 1 unit
 PG = 41G



3RB2056-2FW2

3RB2066-2MF2

Size contactor	Rated power for three-phase motors, rated value ¹⁾	Current setting value of the inverse-time delayed overload release	Short-circuit protection with fuse, type of coordination "2", operational class gG ²⁾	Screw terminals (on auxiliary current side)	Spring-loaded terminals (on auxiliary current side)		
	kW	A	A	Article No.	Price per PU	Article No.	Price per PU

Size S6

Devices with busbar connection, for mounting onto contactor and stand-alone installation

S6	30 ... 90	50 ... 200	315	3RB2056-2FC2	3RB2056-2FF2
----	-----------	------------	-----	---------------------	---------------------

Devices with straight-through transformer, for mounting on contactor and stand-alone installation

For mounting on S6 contactors with box terminals	30 ... 90	50 ... 200	315	3RB2056-2FW2	3RB2056-2FX2
--	-----------	------------	-----	---------------------	---------------------

Size S10/S12²⁾

Devices with busbar connection, for mounting onto contactor and stand-alone installation

S10/S12	30 ... 132	55 ... 250	400	3RB2066-2GC2	3RB2066-2GF2
and size 14 (3TF68/3TF69) ³⁾	90 ... 355	160 ... 630	800	3RB2066-2MC2	3RB2066-2MF2

¹⁾ Guide value for 4-pole standard motors at 50 Hz 400 V AC. The actual starting and rated data of the motor to be protected must be considered when selecting the units.

²⁾ Maximum protection by fuse only for overload relays, type of coordination "2". For fuse values in connection with contactors, see [Configuration Manual](#).

³⁾ For 3TF68/3TF69 contactors, direct mounting is not possible.

Protection equipment

Overload relays

SIRIUS 3RB2 electronic overload relays

3RB20, 3RB21 for standard applications **IE3/IE4 ready**

3RB21 electronic overload relays for mounting on contactors and stand-alone installation, CLASS 5E, 10E, 20E and 30E adjustable

Features and technical specifications:

- Connection methods
 - Size S6
Main circuit: With busbar connection or as straight-through transformer (an appropriate connection kit with screws, spring washers and nuts is enclosed with the devices with busbar connection)
Auxiliary circuit: Either screw or spring-loaded terminals
 - Sizes S10/S12
Main circuit: With busbar connection (an appropriate connection kit with screws, spring washers and nuts is enclosed)
Auxiliary circuit: Either screw or spring-loaded terminals
- Overload protection, phase failure protection and asymmetry protection
- Internal ground-fault detection (activatable)
- Internal power supply
- Auxiliary contacts 1 NO + 1 NC
- Manual and Automatic RESET
- Electrical Remote RESET integrated
- Switch position indicator
- TEST function and self-monitoring

PU (UNIT, SET, M) = 1
PS* = 1 unit
PG = 41G



3RB2153-4FW2

3RB2163-4MF2

Size contactor	Rated power for three-phase motors, rated value ¹⁾	Current setting value of the inverse-time delayed overload release	Short-circuit protection with fuse, type of coordination "2", operational class gG ²⁾	Screw terminals (on auxiliary current side)	Spring-loaded terminals (on auxiliary current side)
	kW	A	A	Article No.	Article No.
				Price per PU	Price per PU

Size S6

Devices with busbar connection, for mounting onto contactor and stand-alone installation

S6	30 ... 90	50 ... 200	315	3RB2153-4FC2	3RB2153-4FF2
----	-----------	------------	-----	---------------------	---------------------

Devices with straight-through transformer, for mounting on contactor and stand-alone installation

For mounting on S6 contactors with box terminals	30 ... 90	50 ... 200	315	3RB2153-4FW2	3RB2153-4FX2
--	-----------	------------	-----	---------------------	---------------------

Size S10/S12²⁾

Devices with busbar connection, for mounting onto contactor and stand-alone installation

S10/S12 and size 14 (3TF68/3TF69) ³⁾	30 ... 132	55 ... 250	400	3RB2163-4GC2	3RB2163-4GF2
	90 ... 355	160 ... 630	800	3RB2163-4MC2	3RB2163-4MF2

¹⁾ Guide value for 4-pole standard motors at 50 Hz 400 V AC. The actual starting and rated data of the motor to be protected must be considered when selecting the units.

²⁾ Maximum protection by fuse only for overload relays, type of coordination "2". For fuse values in connection with contactors, see [Configuration Manual](#).

³⁾ For 3TF68/3TF69 contactors, direct mounting is not possible.







Overview

Overload relays for standard applications

The following optional accessories are available for the 3RB20 and 3RB21 electronic overload relays:

- Mechanical RESET (for all sizes)
- Cable release for resetting devices which are difficult to access (for all sizes)
- Sealable cover (for all sizes)
- Terminal covers for sizes S6 and S10/S12
- Box terminal blocks for sizes S6 and S10/S12

Selection and ordering data

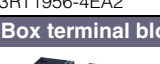
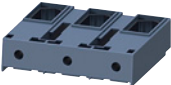
Version	Size	Article No.	Price per PU	PU (UNIT, SET, M)	PS*	PG
Mechanical RESET						
 3RB3980-0A	Resetting plungers, holders and formers S6 ... S12	3RB3980-0A		1	1 unit	41F
 3SU1200-0FB10-0AA0	Pushbuttons with extended stroke (12 mm), IP65, \varnothing 22 mm S6 ... S12	3SU1200-0FB10-0AA0		1	1 unit	41J
 3SU1900-0KG10-0AA0	Extension plungers For compensation of the distance between the pushbutton and the resetting plunger of the relay S6 ... S12	3SU1900-0KG10-0AA0		1	1 unit	41J
Cable releases with holder for RESET						
 3RU3980-0B	For \varnothing 6.5 mm holes in the control panel; max. control panel thickness 8 mm • Length 400 mm • Length 600 mm S6 ... S12 S6 ... S12	3RB3980-0B 3RB3980-0C		1 1	1 unit 1 unit	41F 41F
Sealable covers						
 3RB3984-0	For covering the setting knobs S6 ... S12	3RB3984-0		1	1 unit	41F
Terminal covers						
 3RT1956-4EA1	Covers for cable lugs and busbar connections • Length 100 mm • Length 120 mm S6 S10/S12	3RT1956-4EA1 3RT1966-4EA1		1 1	1 unit 1 unit	41B 41B
 3RT1956-4EA2	Covers for box terminals • Length 25 mm • Length 30 mm S6 S10/S12	3RT1956-4EA2 3RT1966-4EA2		1 1	1 unit 1 unit	41B 41B
 3RT1956-4EA3	Covers for screw terminals Between contactor and overload relay, without box terminals (1 unit required per combination) S6 S10/S12	3RT1956-4EA3 3RT1966-4EA3		1 1	1 unit 1 unit	41B 41B
Box terminal blocks						
 3RT1955-4G	For round and ribbon cables • Up to 70 mm ² • Up to 120 mm ² • Up to 240 mm ² S6 ¹⁾ S6 S10/S12	3RT1955-4G 3RT1956-4G 3RT1966-4G		1 1 1	1 unit 1 unit 1 unit	41B 41B 41B

¹⁾ In the scope of supply for 3RT1054-1 contactors (55 kW).

Protection equipment

Overload relays

SIRIUS 3RB2 electronic overload relays

Accessories for 3RB20, 3RB21

General accessories

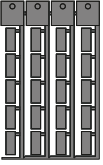
Version	Size	Color	For overload relays	Article No.	Price per PU	PU (UNIT, SET, M)	PS*	PG
Tools for opening spring-loaded terminals								
	Screwdrivers For all SIRIUS devices with spring-loaded terminals	Length approx. 200 mm, 3.0 mm x 0.5 mm	Titanium gray/black, partially insulated	Main and auxiliary circuit connection: 3RB2	Spring-loaded terminals 3RA2908-1A	1	1 unit	41B
Blank labels								
	Unit labeling plates¹⁾ For SIRIUS devices	20 mm x 7 mm	Titanium gray	3RB2	3RT2900-1SB20	100	340 units	41B
	Adhesive labels For SIRIUS devices	19 mm x 6 mm	Titanium gray	3RB2	3RT2900-1SB60	100	3 060 units	41B

¹⁾ PC labeling system for individual inscription of unit labeling plates available from: murrplastik Systemtechnik GmbH (see page 16/18).

Overview

More information

Homepage, see www.siemens.com/sirius-control
 Industry Mall, see www.siemens.com/product?3RB2

Application Manual for switching devices with IE3 and IE4 motors, see <https://support.industry.siemens.com/cs/ww/en/view/94770820>

Operating Instructions, see <https://support.industry.siemens.com/cs/ww/en/view/21833251>

Characteristics and certificates, see <https://support.industry.siemens.com/cs/ww/en/ps/16280>

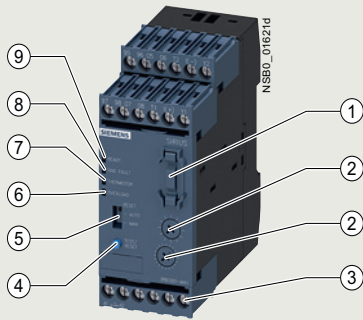

- ① 3RB2985 function expansion module:
Enables more functions to be added, e.g. internal ground-fault detection and/or an analog output with corresponding signals.
- ② Motor current and trip class setting:
Setting the device to the motor current and to the required trip class dependent on the starting conditions is easy with the two rotary switches.
- ③ Connecting terminals (removable terminal block):
The generously sized terminals permit connection of two conductors with different cross-sections for the auxiliary, control and sensor circuits. Connection is possible with screw terminals and alternatively with spring-loaded terminals.
- ④ Test/RESET button:
Enables testing of all important device components and functions, plus resetting of the device after a trip when Manual RESET is selected.
- ⑤ Selector switch for Manual/Automatic RESET:
With this switch you can choose between Manual and Automatic RESET.
- ⑥ Red LED "OVERLOAD":
A continuous red light signals an active overload trip; a flickering red light signals an imminent trip (overload warning).
- ⑦ Red LED "THERMISTOR":
A continuous red light signals an active thermistor trip.
- ⑧ Red LED "GND FAULT":
A continuous red light signals a ground-fault tripping.
- ⑨ Green LED "READY":
A continuous green light signals that the device is working correctly.

SIRIUS 3RB22 and 3RB23 evaluation modules

The 3RB22 and 3RB23 electronic overload relays up to 630 A (up to 820 A possible in combination with a series transformer) are from a modular system and comprise an evaluation unit, a current measuring module and a connecting cable. The 3RB22 overload relays (with monostable auxiliary contacts) and the 3RB23 overload relays (with bistable auxiliary contacts) are supplied from an external voltage.

They have been designed for inverse-time delayed protection of loads with normal and heavy starting against excessive temperature rises due to overload, phase asymmetry or phase failure. An overload, phase asymmetry or phase failure result in an increase of the motor current beyond the set rated motor current.

This current rise is detected by means of a current measuring module (see page 7/137) and electronically evaluated by the evaluation module which is connected to it. The evaluation electronics sends a signal to the auxiliary contacts. The auxiliary contacts then switch off the load by means of a contactor.

The break time depends on the ratio between the tripping current and the current setting I_e and is stored in the form of a long-term stable tripping characteristic curve, see [Characteristics](#). The "tripped" status is signaled by means of a continuously illuminated red "OVERLOAD" LED.

The LED indicates imminent tripping of the relay due to overload, phase asymmetry or phase failure by flickering when the limit current has been violated. In the case of the 3RB22 and 3RB23 overload relays this warning can also be issued through auxiliary contacts.

In addition to the described inverse-time delayed protection of loads against excessive temperature rises, the 3RB22 and 3RB23 electronic overload relays also allow direct temperature monitoring of the motor windings (full motor protection!) by connection with broken-wire interlock of a PTC sensor circuit. With this temperature-dependent protection, the loads can be protected against overheating caused, for example, indirectly by reduced coolant flow and which cannot be detected by means of the current alone. In the event of overheating, the devices switch off the contactor, and thus the load, by means of the auxiliary contacts. The "tripped" status is signaled by means of a continuously illuminated "THERMISTOR" LED.

To protect the loads against incomplete ground faults due to damage to the insulation, humidity, condensed water, etc., the 3RB22 and 3RB23 electronic overload relays offer the possibility of internal ground fault monitoring in conjunction with a function expansion module (for details, see [Operating Instructions](#), not possible in conjunction with contactor assemblies for star-delta (wye-delta) starting). In the event of a ground fault, the 3RB22 and 3RB23 relays trip instantaneously.

The "tripped" status is signaled by means of a continuous red "Ground Fault" LED. Signaling through auxiliary contacts is also possible.

After tripping due to overload, phase asymmetry, phase failure, thermistor or ground-fault tripping, the relay is reset manually or automatically after the recovery time has elapsed.

In conjunction with a corresponding function expansion module, the motor current measured by the microprocessor can be output in the form of a DC 4 to 20 mA analog signal for operating rotary coil instruments or for feeding into analog inputs of programmable logic controllers.

Protection equipment

Overload relays

SIRIUS 3RB2 electronic overload relays

3RB22, 3RB23 for high-feature applications

With an additional AS-Interface analog module the current values can also be transferred via the AS-i bus system.

The 3RB2 electronic overload relays are suitable for operation with frequency converters.

The devices are manufactured in accordance with environmental guidelines and contain environmentally friendly and reusable materials. They comply with all important worldwide standards and approvals.

Article number scheme

Product versions		Article number								
Electronic overload relays		3RB2	<input type="checkbox"/>	<input type="checkbox"/>	<input type="checkbox"/>	-	<input type="checkbox"/>	<input type="checkbox"/>	<input type="checkbox"/>	<input type="checkbox"/>
Device type	e.g. 2 = monostable device for high-feature applications, supplied from external source, for three-phase loads	<input type="checkbox"/>								
Size, rated operational current and power	e.g. 8 = irrespective of size and current		<input type="checkbox"/>							
Version of the Automatic RESET, electrical Remote RESET	e.g. 3 = switchable between Manual/Automatic RESET, with integral electrical Remote RESET			<input type="checkbox"/>						
Trip class (CLASS)	e.g. 4 = CLASS 5E, 10E, 20E, 30E (adjustable)					<input type="checkbox"/>				
Setting range of the overload release	e.g. A = none specified						<input type="checkbox"/>			
Connection methods	e.g. A = screw terminals for auxiliary, control and main circuits							<input type="checkbox"/>		
Installation type	e.g. 1 = stand-alone installation								<input type="checkbox"/>	
Example		3RB2	2	8	3	-	4	A	A	1

Note:

The article number scheme shows an overview of product versions for better understanding of the logic behind the article numbers.

Use in hazardous areas

The 3RB22 electronic overload relays (monostable) with the 3RB29 current measuring module are suitable for the overload protection of explosion-proof motors.

EC type-examination certificate for Category (2) G/D exists. It has the number PTB 05 ATEX 3022.

For your orders, please use the article numbers quoted in the selection and ordering data.

Benefits

The most important features and benefits of the 3RB22 and 3RB23 electronic overload relays are listed in the overview table, see "General data", page 7/76 onwards.

Application

Industries

The 3RB22 and 3RB23 electronic overload relays are suitable for customers from all industries who want to guarantee optimum inverse-time delayed and temperature-dependent protection of their electrical loads (e.g. motors) under normal and heavy starting conditions (CLASS 5 to CLASS 30), minimize project completion times, inventories and power consumption, and optimize plant availability and maintenance management.

Application

The 3RB22 and 3RB23 devices have been designed for the protection of three-phase asynchronous and single-phase AC motors.

If single-phase AC motors are to be protected by the 3RB22 and 3RB23 electronic overload relays, the main conducting paths of the current measuring modules must be series-connected. For circuit diagrams, see [Operating Instructions](#).

Ambient conditions

The devices are insensitive to external influences such as shocks, corrosive ambient conditions, aging and temperature fluctuations.

For the temperature range from -25 to +60 °C, the 3RB22 and 3RB23 electronic overload relays compensate the temperature in accordance with IEC 60947-4-1.

Configuration notes for use of the devices below -25 °C or above +60 °C on request.

Use of SIRIUS protection devices in conjunction with IE3 and IE4 motors

Note:

For the use of 3RB22 and 3RB23 electronic overload relays in conjunction with highly efficient IE3 and IE4 motors, please observe the information on dimensioning and configuring, see [Application Manual](#).

For more information, see [page 1/8](#).

Technical specifications

More information

Application Manual for switching devices with IE3 and IE4 motors, see <https://support.industry.siemens.com/cs/ww/en/view/94770820>
 Configuration Manual for load feeders, see <https://support.industry.siemens.com/cs/ww/en/view/39714188>

Operating Instructions, see <https://support.industry.siemens.com/cs/ww/en/view/21833251>
 Technical specifications, see <https://support.industry.siemens.com/cs/ww/en/ps/16280/td>

The following technical information is intended to provide an initial overview of the various types of devices and functions.

Type – Overload relay: Evaluation modules

Size contactor
 Dimensions of evaluation modules (W x H x D)

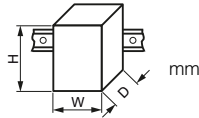

3RB2283-4A.1

S00 ... S10/S12
 45 x 111 x 95

3RB2383-4A.1

General data

Tripping in the event of

Overload, phase failure and phase asymmetry (> 40% according to NEMA), + ground fault (with corresponding function expansion module) and activation of the thermistor motor protection (with closed PTC sensor circuit)

Trip class according to IEC 60947-4-1

CLASS 5E, 10E, 20E and 30E adjustable

Phase failure sensitivity

Yes

Overload warning

Yes, from $1.125 \times I_g$ for symmetrical loads and from $0.85 \times I_g$ for asymmetrical loads

Reset and recovery

- Reset options after tripping
- Recovery time

Manual, Automatic and Remote RESET

- For Automatic RESET

min.

- For tripping due to overcurrent: 3 (stored permanently)
 - For tripping by thermistor: time until the motor temperature has fallen 5 K below the response temperature
 - For tripping due to a ground fault: no Automatic RESET

- For Manual RESET

min.

- For tripping due to overcurrent: 3 (stored permanently)
 - For tripping by thermistor: time until the motor temperature has fallen 5 K below the response temperature
 - For tripping due to a ground fault: immediately

- For Remote RESET

min.

- For tripping due to overcurrent: 3 (stored permanently)
 - For tripping by thermistor: time until the motor temperature has fallen 5 K below the response temperature
 - For tripping due to a ground fault: immediately

Features

- Display of operating state on device

Yes, with four LEDs:
 - Green LED "Ready"
 - Red LED "Ground Fault"
 - Red LED "Thermistor"
 - Red LED "Overload"

- TEST function

Yes, test of LEDs, electronics, auxiliary contacts and wiring of control circuit by pressing the button TEST/RESET/self-monitoring

- RESET button

Yes, with the TEST/RESET button

- STOP button

No

Protection and operation of explosion-proof motors

Certificate of suitability/explosion protection type according to ATEX Directive 2014/34/EU

PTB 05 ATEX 3022  II (2) GD
 see <https://support.automation.siemens.com/WW/en/view/en/23115758>

--

Ambient temperatures

- Storage/transport
- Operation
- Temperature compensation
- Permissible rated current

°C

-40 ... +80

°C

-25 ... +60

°C

+60

- Temperature inside control cabinet 60 °C
- Temperature inside control cabinet 70 °C

%

100

%

On request

Degree of protection IP on the front according to IEC 60529

IP20

Touch protection on the front according to IEC 60529

Finger-safe for vertical touching from the front

Shock resistance with sine according to IEC 60068-2-27

g/ms

15/11

Protection equipment



Overload relays

SIRIUS 3RB2 electronic overload relays

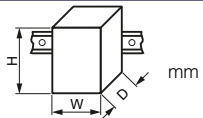
3RB22, 3RB23 for high-feature applications

Type – Overload relay: Evaluation modules		3RB2283-4A.1	3RB2383-4A.1
Size contactor		S00 ... S10/S12	
Dimensions of evaluation modules (W x H x D)		45 x 111 x 95	
General data (continued)			
Electromagnetic compatibility (EMC) – Interference immunity			
• Conductor-related interference			
- Burst according to IEC 61000-4-4 (corresponds to degree of severity 3)	kV	2 (power ports), 1 (signal port)	
- Surge according to IEC 61000-4-5 (corresponds to degree of severity 3)	kV	2 (line to earth), 1 (line to line)	
• Electrostatic discharge according to IEC 61000-4-2 (corresponds to degree of severity 3)	kV	8 (air discharge), 6 (contact discharge)	
• Field-related interference according to IEC 61000-4-3 (corresponds to degree of severity 3)	V/m	10	
Electromagnetic compatibility (EMC) – Emitted interference		Degree of severity A according to EN 55011 (CISPR 11) and EN 55022 (CISPR 22)	
Installation altitude above sea level		m	Up to 2 000
Mounting position		Any	
Type of mounting			
• Evaluation modules		Stand-alone installation	
• Current measuring modules	Size	S00 to S3: Stand-alone installation, S6 and S10/S12: Stand-alone installation or mounting on contactors	
Type – Overload relay: Evaluation modules		3RB2283-4A.1, 3RB2383-4A.1	
Size contactor		S00 ... S10/S12	
Auxiliary circuit			
Number of NO contacts		2	
Number of NC contacts		2	
Number of CO contacts		--	
Auxiliary contacts – Assignment		<ul style="list-style-type: none"> • Alternative 1 <ul style="list-style-type: none"> - 1 NO for the signal "tripped by overload and/or thermistor", - 1 NC for disconnecting the contactor, - 1 NO for the signal "tripped by ground fault", - 1 NC for disconnecting the contactor or¹⁾ • Alternative 2 <ul style="list-style-type: none"> - 1 NO for the signal "tripped by overload and/or thermistor and/or ground fault", - 1 NC for disconnecting the contactor, - 1 NO for overload warning, - 1 NC for disconnecting the contactor 	
Rated insulation voltage U_i (pollution degree 3)		V	300
Rated impulse withstand voltage U_{imp}		kV	4
Auxiliary contacts – Contact rating			
• NC, NO contact with alternating current AC-14/AC-15, rated operational current I_e at U_e			
- 24 V	A	6	
- 120 V	A	6	
- 125 V	A	6	
- 250 V	A	3	
• NC, NO contacts with direct current DC-13, rated operational current I_e at U_e			
- 24 V	A	2	
- 60 V	A	0.55	
- 110 V	A	0.3	
- 125 V	A	0.3	
- 250 V	A	0.2	
• Conventional thermal current I_{th}	A	5	
• Contact reliability (suitability for PLC control; 17 V, 5 mA)		Yes	
Short-circuit protection			
• With fuse, operational class gG	A	6	
• With miniature circuit breaker, C characteristic	A	1.6	
Protective separation between auxiliary conducting paths		V	300
According to IEC 60947-1			
CSA, UL and UR rated data			
Auxiliary circuit – Switching capacity		B300, R300	

¹⁾ The assignment of auxiliary contacts may be influenced by function expansion modules.

Type – Overload relay: Evaluation modules		3RB2283-4A.1, 3RB2383-4A.1	
Size contactor		S00 ... S10/S12	
Control circuit			
Rated insulation voltage U_i (pollution degree 3)	V	300	
Rated impulse withstand voltage U_{imp}	kV	4	
Rated control supply voltage U_s			
• 50/60 Hz AC	V	24 ... 240	
• DC	V	24 ... 240	
Operating range			
• 50/60 Hz AC		$0.85 \times U_{s \min} \leq U_s \leq 1.1 \times U_{s \max}$	
• DC		$0.85 \times U_{s \min} \leq U_s \leq 1.1 \times U_{s \max}$	
Rated power			
• 50/60 Hz AC	W	0.5	
• DC	W	0.5	
Mains buffering time	ms	200	
Sensor circuit			
Thermistor motor protection (PTC thermistor sensor)			
• Summation cold resistance	k Ω	≤ 1.5	
• Response value	k Ω	3.4 ... 3.8	
• Return value	k Ω	1.5 ... 1.65	
Ground-fault detection			
The information refers to sinusoidal residual currents at 50/60 Hz.			
• Tripping value $I_{\Delta}^{1)}$			
- For $0.3 \times I_e < I_{motor} < 2.0 \times I_e$		$> 0.3 \times I_e$	
- For $2.0 \times I_e < I_{motor} < 8.0 \times I_e$		$> 0.15 \times I_{motor}$	
• Response time t_{trip}	ms	500 ... 1 000	
Analog output¹⁾²⁾			
Rated values			
• Output signal	mA	4 ... 20	
• Measuring range		0 ... $1.25 \times I_e$ 4 mA corresponds to $0 \times I_e$ 16.8 mA corresponds to $1.0 \times I_e$ 20 mA corresponds to $1.25 \times I_e$	
• Load, max.	Ω	100	
Conductor cross-sections for the auxiliary, control and sensor circuits as well as the analog output			
Connection type		 Screw terminals	
Terminal screw		M3, Pozidriv size 2	
Operating devices		mm	3.0 x 0.5
Prescribed tightening torque		Nm	0.8 ... 1.2
Conductor cross-sections (min./max.), one or two conductors can be connected			
• Solid or stranded	mm ²	$1 \times (0.5 \dots 4)^3, 2 \times (0.5 \dots 2.5)^3$	
• Finely stranded without end sleeve	mm ²	--	
• Finely stranded with end sleeve (DIN 46228)	mm ²	$1 \times (0.5 \dots 2.5)^3, 2 \times (0.5 \dots 1.5)^3$	
• AWG cables, solid or stranded	AWG	2 x (20 ... 14)	
Connection type		 Spring-loaded terminals	
Operating devices		mm	3.0 x 0.5
Conductor cross-sections (min./max.), one or two conductors can be connected			
• Solid or stranded	mm ²	2 x (0.25 ... 1.5)	
• Finely stranded without end sleeve	mm ²	--	
• Finely stranded with end sleeve (DIN 46228)	mm ²	2 x (0.25 ... 1.5)	
• AWG cables, solid or stranded	AWG	2 x (24 ... 16)	

1) For the 3RB22 and 3RB23 overload relays in combination with a corresponding function expansion module.

2) Analog input modules, e.g. SM 331, must be configured for four-wire measuring transducers. In this case the analog input module must not supply current to the analog output of the 3RB22 and 3RB23 relay.

3) If two different conductor cross-sections are connected to one clamping point, both cross-sections must be in the range specified.

Protection equipment

Overload relays

SIRIUS 3RB2 electronic overload relays

3RB22, 3RB23 for high-feature applications

Functions of the 3RB22 and 3RB23 evaluation modules in combination with the 3RB2985 function expansion modules

Evaluation modules	With function expansion module	Basic functions	Inputs		
			A1/A2	T1/T2	Y1/Y2
3RB2283-4AA1 3RB2283-4AC1 3RB2383-4AA1 3RB2383-4AC1	--	Inverse-time delayed protection, temperature-dependent protection, electrical Remote RESET, overload warning	Power supply 24 ... 240 V AC/DC	Connection for PTC sensor	Electrical Remote RESET
	3RB2985-2CA1	Inverse-time delayed protection, temperature-dependent protection, internal ground-fault detection, electrical Remote RESET, overload warning	Power supply 24 ... 240 V AC/DC	Connection for PTC sensor	Electrical Remote RESET
	3RB2985-2CB1	Inverse-time delayed protection, temperature-dependent protection, internal ground-fault detection, electrical Remote RESET, ground-fault signal	Power supply 24 ... 240 V AC/DC	Connection for PTC sensor	Electrical Remote RESET
	3RB2985-2AA0	Inverse-time delayed protection, temperature-dependent protection, electrical Remote RESET, overload warning, analog output	Power supply 24 ... 240 V AC/DC	Connection for PTC sensor	Electrical Remote RESET
	3RB2985-2AA1	Inverse-time delayed protection, temperature-dependent protection, internal ground-fault detection, electrical Remote RESET, overload warning, analog output	Power supply 24 ... 240 V AC/DC	Connection for PTC sensor	Electrical Remote RESET
	3RB2985-2AB1	Inverse-time delayed protection, temperature-dependent protection, internal ground-fault detection, electrical Remote RESET, ground-fault signal, analog output	Power supply 24 ... 240 V AC/DC	Connection for PTC sensor	Electrical Remote RESET

Evaluation modules	With function expansion module	Outputs I (-)/I (+)	95/96 NC				97/98 NO		05/06 NC		07/08 NO	
			95/96 NC		97/98 NO		05/06 NC		07/08 NO			
3RB2283-4AA1 3RB2283-4AC1 3RB2383-4AA1 3RB2383-4AC1	--	No	Disconnection of the contactor (inverse-time delayed/ temperature-dependent protection)		Signal "tripped"		Overload warning		Overload warning			
	3RB2985-2CA1	No	Disconnection of the contactor (inverse-time delayed/ temperature-dependent protection + ground fault)		Signal "tripped"		Overload warning		Overload warning			
	3RB2985-2CB1	No	Disconnection of the contactor (inverse-time delayed/ temperature-dependent protection)		Signal "tripped"		Disconnection of the contactor (ground fault)		Signal "ground-fault tripping"			
	3RB2985-2AA0	Analog signal	Disconnection of the contactor (inverse-time delayed/ temperature-dependent protection)		Signal "tripped"		Overload warning		Overload warning			
	3RB2985-2AA1	Analog signal	Disconnection of the contactor (inverse-time delayed/ temperature-dependent protection + ground fault)		Signal "tripped"		Overload warning		Overload warning			
	3RB2985-2AB1	Analog signal	Disconnection of the contactor (inverse-time delayed/ temperature-dependent protection)		Signal "tripped"		Disconnection of the contactor (ground fault)		Signal "ground-fault tripping"			

Protection equipment

Overload relays

SIRIUS 3RB2 electronic overload relays

IE3/IE4 ready 3RB22, 3RB23 for high-feature applications

3RB22 and 3RB23 electronic overload relays (evaluation modules) for full motor protection for stand-alone installation, CLASS 5E, 10E, 20E and 30E (adjustable)

Type	3RB2283-4A.1, 3RB2383-4A.1
Features and technical specifications	
Overload protection, phase failure protection and asymmetry protection	✓
Supplied from an external source	✓
	24 ... 240 V AC/DC
Auxiliary contacts	✓
	2 NO + 2 NC
Electrical Remote RESET integrated	✓
Four LEDs for operating and status displays	✓
TEST function and self-monitoring	✓
Internal ground-fault detection	✓
	(with function expansion module)
Screw or spring-loaded terminals for auxiliary, control and sensor circuits	✓
Input for PTC sensor circuit	✓
Analog output	✓
	(with function expansion module)

✓ Available

Selection and ordering data



PU (UNIT, SET, M) = 1
 PS* = 1 unit
 PG = 41G



3RB2283-4AA1



3RB2283-4AC1

Size contactor	Version	Screw terminals 	Spring-loaded terminals 
		Article No. Price per PU	Article No. Price per PU

Evaluation modules

S00 ... S12	Monostable	3RB2283-4AA1	3RB2283-4AC1
	Bistable	3RB2383-4AA1	3RB2383-4AC1

Note:

Overview of overload relays – matching contactors, see page 7/81.

Current measuring modules and related connecting cables, see page 7/137, general accessories, see page 7/138 onwards.

Protection equipment

Overload relays

SIRIUS 3RB2 electronic overload relays

3RB22, 3RB23 for high-feature applications **IE3/IE4 ready**

Function expansion modules for 3RB22 and 3RB23 overload relays (evaluation modules)

Size contactor	Version	For overload relays	Article No.	Price per PU	PU (UNIT, SET, M)	PS*	PG
Sizes S00 to S12							
		For plugging into evaluation module (1 unit)					
 3RB2985-2..1	S00 ... S12	Analog Basic 1 modules ¹⁾ Analog output 4 ... 20 mA DC, with overload warning	3RB22, 3RB23	3RB2985-2AA0	1	1 unit	41F
		Analog Basic 1 GF modules ¹⁾²⁾ Analog output 4 ... 20 mA DC, with internal ground-fault detection and overload warning	3RB22, 3RB23	3RB2985-2AA1	1	1 unit	41F
		Analog Basic 2 GF modules ¹⁾²⁾ Analog output 4 ... 20 mA DC, with internal ground-fault detection and ground-fault signaling	3RB22, 3RB23	3RB2985-2AB1	1	1 unit	41F
		Basic 1 GF modules ²⁾ with internal ground-fault detection and overload warning	3RB22, 3RB23	3RB2985-2CA1	1	1 unit	41F
		Basic 2 GF modules ²⁾ with internal ground-fault detection and ground-fault signaling	3RB22, 3RB23	3RB2985-2CB1	1	1 unit	41F

¹⁾ The analog signal 4 to 20 mA DC can be used for operating rotary coil instruments or for feeding into analog inputs of programmable logic controllers.

²⁾ The following information on ground-fault protection refers to sinusoidal residual currents at 50/60 Hz:

- With a motor current of between 0.3 and 2 times the current setting I_e , the unit will trip at a ground-fault current equal to 30% of the current setting.
- With a motor current of between 2 and 8 times the current setting I_e , the unit will trip at a ground-fault current equal to 15% of the motor current.
- The response delay amounts to between 0.5 s and 1 s.

Note:

Analog input modules, e.g. SM 331, must be configured for four-wire measuring transducers. In this case the analog input module must not supply current to the analog output of the 3RB22/3RB23 relay.

Overview

More information

Homepage, see www.siemens.com/sirius-control
 Industry Mall, see www.siemens.com/product?3RB2

Application Manual for switching devices with IE3 and IE4 motors, see <https://support.industry.siemens.com/cs/ww/en/view/94770820>

Equipment Manual, see <https://support.industry.siemens.com/cs/ww/en/view/46165627>

Certificates, see <https://support.industry.siemens.com/cs/ww/en/ps/16281/cert>

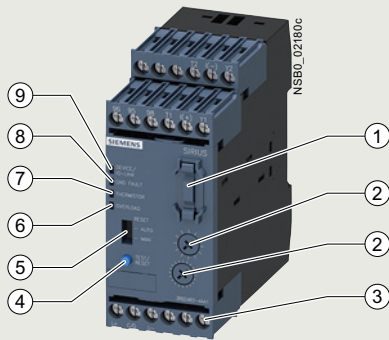

- ① Plug-in point for operator panel:
enables connection of the 3RA6935-0A operator panel.
- ② Motor current and trip class setting:
Setting the device to the motor current and to the required trip class dependent on the starting conditions is easy with the two rotary switches.
- ③ Connecting terminals (removable terminal block):
The generously sized terminals permit connection of two conductors with different cross-sections for the auxiliary, control and sensor circuits. Connection is possible with screw terminals and alternatively with spring-loaded terminals.
- ④ Test/RESET button:
Enables testing of all important device components and functions, plus resetting of the device after a trip when Manual RESET is selected.
- ⑤ Selector switch for Manual/Automatic RESET:
With this switch you can choose between Manual and Automatic RESET.
- ⑥ Red LED "OVERLOAD":
A continuous red light signals an active overload trip; a flickering led light signals an imminent trip (overload warning).
- ⑦ Red LED "THERMISTOR":
A continuous red light signals an active thermistor trip.
- ⑧ Red LED "GND FAULT":
A continuous red light signals an active ground-fault trip.
- ⑨ Green LED "DEVICE/IO-Link":
A continuous green light signals that the device is working correctly, a green flickering light signals the communication through IO-Link.

SIRIUS 3RB24 evaluation module

The modular, IO-Link powered 3RB24 electronic overload relays (with monostable auxiliary contacts) up to 630 A (up to 820 A possible with a series transformer) have been designed for inverse-time delayed protection of loads with normal and heavy starting against excessive temperature rises due to overload, phase asymmetry or phase failure. These comprise an evaluation unit, a current measuring module and a connecting cable.

The 3RB24 evaluation module also offers a motor starter function: The contactors, which are connected via the auxiliary contacts, can also be actuated for operation via IO-Link. In this way, direct, reversing and star-delta (wye-delta) starters up to 630 A (or 830 A) can be connected to the controller via the IO-Link.

An overload, phase asymmetry or phase failure result in an increase of the motor current beyond the set rated motor current.

This current rise is detected by means of the current measuring module (see page 7/137) and electronically evaluated by the evaluation module which is connected to it. The evaluation electronics sends a signal to the auxiliary contacts. The auxiliary contacts then switch off the load by means of a contactor.

The break time depends on the ratio between the tripping current and the current setting I_e and is stored in the form of a long-term stable tripping characteristic curve, see [Equipment Manual](#). The "tripped" status is signaled by means of a continuously illuminated red "OVERLOAD" LED and also reported as a group fault via IO-Link.

The LED indicates imminent tripping of the relay due to overload, phase asymmetry or phase failure by flickering when the limit current has been violated. This warning can also be reported to the higher-level PLC via IO-Link at the 3RB24 overload relays.

In addition to the described inverse-time delayed protection of loads against excessive temperature rises, the 3RB24 electronic overload relays also allow direct temperature monitoring of the motor windings (full motor protection!) by connection with broken-wire interlock of a PTC sensor circuit. With this temperature-dependent protection, the loads can be protected against overheating caused, for example, indirectly by reduced coolant flow and which cannot be detected by means of the current alone. In the event of overheating, the devices switch off the contactor, and thus the load, by means of the auxiliary contacts. The "tripped" status is signaled by means of a continuously illuminated "THERMISTOR" LED and also reported as a group fault via IO-Link.

To protect the loads against incomplete ground faults due to damage to the insulation, humidity, condensation, etc., the 3RB24 electronic overload relays offer the possibility of internal ground-fault detection (for details, see [Equipment Manual](#), not possible in conjunction with contactor assemblies for star-delta (wye-delta) starting). In the event of a ground fault, the 3RB24 relays trip instantaneously.

The "tripped" status is signaled by means of a flashing red "Ground Fault" LED and reported at the 3RB24 overload relay as a group fault via IO-Link.

The reset after overload, phase asymmetry, phase failure, thermistor or ground-fault tripping is performed manually by key on site, via IO-Link or by electrical Remote RESET or automatically after the cooling time (motor model) or for thermistor protection after sufficient cooling. Trips in devices initiated by function monitoring systems (broken wire or short-circuit on the thermistor) can only be reset locally.

A motor current measured by the microprocessor can be output in the form of an analog signal 4 to 20 mA DC for operating rotary coil instruments or for feeding into analog inputs of programmable logic controllers.

Protection equipment

Overload relays

SIRIUS 3RB2 electronic overload relays

3RB24 for IO-Link for high-feature applications

The current values can be transmitted to the higher-level controller via IO-Link.

The 3RB24 electronic overload relay for IO-Link is suitable for operation with frequency converters.

The devices are manufactured in accordance with environmental guidelines and contain environmentally friendly and reusable materials. They comply with all important worldwide standards and approvals.

Use in hazardous areas

The 3RB24 electronic overload relays for IO-Link with the 3RB29 current measuring module are suitable for the overload protection of motors with the following types of protection:

- Ex II (2) G [Ex e] [Ex d] [Ex px]
- Ex II (2) D [Ex t] [Ex p]

EC type-examination certificate for Group II, Category (2) G/D exists. It has the number PTB 11 ATEX 3014.

Article number scheme

Product versions		Article number					
Electronic overload relays		3RB2 □ □ □ - □ □ □ □					
Device type	e.g. 4 = monostable device for high-feature applications, supplied from external source (24 V DC), for three-phase loads	□					
Size, rated operational current and power	e.g. 8 = irrespective of size and current		□				
Version of the Automatic RESET, electrical Remote RESET	e.g. 3 = switchable between Manual/Automatic RESET, with integral electrical Remote RESET			□			
Trip class (CLASS)	e.g. 4 = CLASS 5E, 10E, 20E, 30E (adjustable)					□	
Setting range of the overload release	e.g. A = none specified						□
Connection methods	e.g. A = screw terminals for auxiliary, control and main circuits						□
Installation type	e.g. 1 = stand-alone installation						□
Example		3RB2 4 8 3 - 4 A A 1					

Note:

The article number scheme shows an overview of product versions for better understanding of the logic behind the article numbers.

For your orders, please use the article numbers quoted in the selection and ordering data.

Application

Industries

The 3RB24 electronic overload relays are suitable for customers from all industries who want to guarantee optimum current and temperature-dependent protection of their electrical loads (e.g. motors) under normal and heavy starting conditions (CLASS 5E to 30E), minimize project completion times, inventories and energy consumption, and optimize plant availability and maintenance management.

Application

The 3RB24 electronic overload relays have been designed for the protection of three-phase asynchronous and single-phase AC motors.

In addition to protection function, these devices can be used together with contactors as direct-on-line or reversing starters (star-delta (wye-delta) start also possible), which are controlled via IO-Link. This makes it possible to directly control drives via IO-Link from a higher-level controller or on site via the optional handheld device and also, for example, to return current values directly via IO-Link.

If single-phase AC motors are to be protected by the 3RB24 electronic overload relays, the main conducting paths of the current measuring modules must be series-connected (circuit diagrams, see [Equipment Manual](#)).

Ambient conditions

The devices are insensitive to external influences such as shocks, corrosive ambient conditions, aging and temperature fluctuations.

In the temperature range from -25 to +60 °C, the 3RB24 electronic overload relays compensate the temperature in accordance with IEC 60947-4-1.

Configuration notes for use of the devices below -25 °C or above +60 °C on request.

Use of SIRIUS protection devices in conjunction with IE3 and IE4 motors

Note:

For the use of 3RB24 electronic overload relays in conjunction with highly efficient IE3 and IE4 motors, please observe the information on dimensioning and configuring, see [Application Manual](#).

For more information, see [page 1/8](#).

Technical specifications

More information

Application Manual for switching devices with IE3 and IE4 motors, see <https://support.industry.siemens.com/cs/ww/en/view/94770820>

Configuration Manual for load feeders, see <https://support.industry.siemens.com/cs/ww/en/view/39714188>

Equipment Manual, see <https://support.industry.siemens.com/cs/ww/en/view/46165627>

Technical specifications, see <https://support.industry.siemens.com/cs/ww/en/ps/16281/td>

The following technical information is intended to provide an initial overview of the various types of devices and functions.

Type – Overload relay: Evaluation modules

Size contactor
Dimensions of evaluation modules (W x H x D)

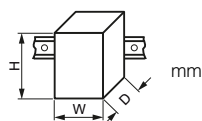

3RB243-4A.1

S00 ... S10/S12
45 x 111 x 95

General data

Tripping in the event of	Overload, phase failure and phase asymmetry (> 40% according to NEMA), + ground fault (connectable and disconnectable) and activation of the thermistor motor protection (with closed PTC sensor circuit)
Trip class according to IEC 60947-4-1	CLASS 5E, 10E, 20E and 30E adjustable
Phase failure sensitivity	Yes
Overload warning	Yes, from $1.125 \times I_e$ for symmetrical loads and from $0.85 \times I_e$ for asymmetrical loads
Reset and recovery	Manual and Automatic RESET, electrical Remote RESET or via IO-Link
<ul style="list-style-type: none"> • Reset options after tripping • Recovery time <ul style="list-style-type: none"> - For Automatic RESET - For Manual RESET - For Remote RESET 	<ul style="list-style-type: none"> min. - For tripping due to overcurrent: 3 (stored permanently) - For tripping by thermistor: time until the motor temperature has fallen 5 K below the response temperature - For tripping due to a ground fault: no Automatic RESET min. - For tripping due to overcurrent: 3 (stored permanently) - For tripping by thermistor: time until the motor temperature has fallen 5 K below the response temperature - For tripping due to a ground fault: immediately min. - For tripping due to overcurrent: 3 (stored permanently) - For tripping by thermistor: time until the motor temperature has fallen 5 K below the response temperature - For tripping due to a ground fault: immediately

Protection equipment

Overload relays

SIRIUS 3RB2 electronic overload relays

3RB24 for IO-Link for high-feature applications



Type – Overload relay: Evaluation modules			3RB2483-4A.1
Size contactor			S00 ... S10/S12
Dimensions of evaluation modules (W x H x D)		mm	45 x 111 x 95
General data (continued)			
Features			
• Display of operating state on device			Yes, with four LEDs: <ul style="list-style-type: none"> - Green "DEVICE/IO-Link" LED - Red LED "Ground Fault" - Red LED "Thermistor" - Red LED "Overload"
• TEST function			Yes, test of LEDs, electronics, auxiliary contacts and wiring of control circuit by pressing the TEST/RESET button/self-monitoring
• RESET button			Yes, with the TEST/RESET button
• STOP button			No
Protection and operation of explosion-proof motors			
Certificate of suitability/explosion protection type according to ATEX Directive 2014/34/EU			PTB 11 ATEX 3014 II (2) G [Ex e] [Ex d] [Ex px] II (2) D [Ex t] [Ex p] See https://support.industry.siemens.com/cs/ww/en/view/60524083
Ambient temperatures			
• Storage/transport	°C		-40 ... +80
• Operation	°C		-25 ... +60
• Temperature compensation	°C		+60
• Permissible rated current			
- Temperature inside control cabinet 60 °C	%		100
- Temperature inside control cabinet 70 °C	%		On request
Degree of protection IP on the front according to IEC 60529			IP20
Touch protection on the front according to IEC 60529			Finger-safe for vertical touching from the front
Shock resistance with sine according to IEC 60068-2-27		g/ms	15/11
Electromagnetic compatibility (EMC) – Interference immunity			
• Conductor-related interference			
- Burst according to IEC 61000-4-4 (corresponds to degree of severity 3)	kV		2 (power ports), 1 (signal port)
- Surge according to IEC 61000-4-5 (corresponds to degree of severity 3)	kV		2 (line to earth), 1 (line to line)
• Electrostatic discharge according to IEC 61000-4-2 (corresponds to degree of severity 3)	kV		8 (air discharge), 6 (contact discharge)
• Field-related interference according to IEC 61000-4-3 (corresponds to degree of severity 3)	V/m		10
Electromagnetic compatibility (EMC) – Emitted interference			Degree of severity A according to EN 55011 (CISPR 11) and EN 55022 (CISPR 22)
Installation altitude above sea level		m	Up to 2 000
Mounting position			Any
Type of mounting			
• Evaluation modules			Stand-alone installation
• Current measuring modules	Size		S00 to S3: Stand-alone installation, S6 and S10/S12: Stand-alone installation or mounting on contactors

Protection equipment

Overload relays

SIRIUS 3RB2 electronic overload relays

3RB24 for IO-Link for high-feature applications

Type – Overload relay: Evaluation modules		3RB2483-4A.1
Size contactor		S00 ... S10/S12
Auxiliary circuit		
Number of auxiliary switches		1 CO contact, 1 NO contact connected in series internally
Auxiliary contacts – Assignment		<ul style="list-style-type: none"> • 1 CO contact for selecting the contactor (for reversing starter function), actuated by the control system • 1 NO contact for normal switching duty, actuated by the control system (opens automatically when tripping occurs)
Rated insulation voltage U_i (pollution degree 3)	V	300
Rated impulse withstand voltage U_{imp}	kV	4
Auxiliary contacts – Contact rating		
<ul style="list-style-type: none"> • NC, NO contact with alternating current AC-14/AC-15, rated operational current I_e at U_e <ul style="list-style-type: none"> - 24 V - 120 V - 125 V - 250 V • NC, NO contacts with direct current DC-13, rated operational current I_e at U_e <ul style="list-style-type: none"> - 24 V - 60 V - 110 V - 125 V - 250 V • Conventional thermal current I_{th} • Contact reliability (suitability for PLC control; 17 V, 5 mA) 	A	6 6 6 3 2 0.55 0.3 0.3 0.2 5 Yes
Short-circuit protection		
<ul style="list-style-type: none"> • With fuse, operational class gG • With miniature circuit breaker, C characteristic 	A	6 1.6
Protective separation between auxiliary conducting paths according to IEC 60947-1		V 300
CSA, UL and UR rated data		
Auxiliary circuit – Switching capacity		B300, R300
Conductor cross-sections of the auxiliary circuit		
Connection type		 Screw terminals
Terminal screw		M3, Pozidriv size 2
Operating devices	mm	3.0 x 0.5
Prescribed tightening torque	Nm	0.8 ... 1.2
Conductor cross-sections (min./max.), one or two conductors can be connected		
• Solid or stranded	mm ²	1 x (0.5 ... 4) ¹⁾ , 2 x (0.5 ... 2.5) ¹⁾
• Finely stranded without end sleeve	mm ²	--
• Finely stranded with end sleeve (DIN 46228)	mm ²	1 x (0.5 ... 2.5) ¹⁾ , 2 x (0.5 ... 1.5) ¹⁾
• AWG cables, solid or stranded	AWG	2 x (20 ... 14)
Connection type		 Spring-loaded terminals
Operating devices	mm	3.0 x 0.5
Conductor cross-sections (min./max.), one or two conductors can be connected		
• Solid or stranded	mm ²	2 x (0.25 ... 1.5)
• Finely stranded without end sleeve	mm ²	--
• Finely stranded with end sleeve (DIN 46228)	mm ²	2 x (0.25 ... 1.5)
• AWG cables, solid or stranded	AWG	2 x (24 ... 16)



¹⁾ If two different conductor cross-sections are connected to one clamping point, both cross-sections must be in the range specified.

Protection equipment

Overload relays

SIRIUS 3RB2 electronic overload relays

3RB24 for IO-Link for high-feature applications

Type – Overload relay: Evaluation modules		3RB2483-4A.1
Size contactor		S00 ... S10/S12
Control circuit		
Rated insulation voltage U_i (pollution degree 3)	V	300
Rated impulse withstand voltage U_{imp}	kV	4
Rated control supply voltage U_s¹⁾	V	24 via IO-Link
• DC		
Operating range		
• DC		$0.85 \times U_{s\ min} \leq U_s \leq 1.1 \times U_{s\ max}$
Rated power		
• DC	W	0.5
Mains buffering time		
	ms	200
Sensor circuit		
Thermistor motor protection (PTC thermistor sensor)		
• Summation cold resistance	k Ω	≤ 1.5
• Response value	k Ω	3.4 ... 3.8
• Return value	k Ω	1.5 ... 1.65
Ground-fault detection		
• Tripping value I_{Δ}		The information refers to sinusoidal residual currents at 50/60 Hz.
- For $0.3 \times I_e < I_{motor} < 2.0 \times I_e$		$> 0.3 \times I_e$
- For $2.0 \times I_e < I_{motor} < 8.0 \times I_e$		$> 0.15 \times I_{motor}$
• Response time t_{trip}	ms	500 ... 1 000
Analog output¹⁾		
Rated values		
• Output signal	mA	4 ... 20
• Measuring range		0 ... $1.25 \times I_e$ 4 mA corresponds to $0 \times I_e$ 16.8 mA corresponds to $1.0 \times I_e$ 20 mA corresponds to $1.25 \times I_e$
• Load, max.	Ω	100
Conductor cross-sections for the control and sensor circuit as well as the analog output		
Connection type		 Screw terminals
Terminal screw		M3, Pozidriv size 2
Operating devices		mm 3.0 x 0.5
Prescribed tightening torque		Nm 0.8 ... 1.2
Conductor cross-sections (min./max.), one or two conductors can be connected		
• Solid	mm ²	$1 \times (0.5 \dots 4)^2, 2 \times (0.5 \dots 2.5)^2$
• Finely stranded without end sleeve	mm ²	--
• Finely stranded with end sleeve (DIN 46228)	mm ²	$1 \times (0.5 \dots 2.5)^2, 2 \times (0.5 \dots 1.5)^2$
• Stranded	mm ²	--
• AWG cables, solid or stranded	AWG	2 x (20 ... 14)
Connection type		 Spring-loaded terminals
Operating devices		mm 3.0 x 0.5
Conductor cross-sections (min./max.), one or two conductors can be connected		
• Solid	mm ²	2 x (0.25 ... 1.5)
• Finely stranded without end sleeve	mm ²	--
• Finely stranded with end sleeve (DIN 46228)	mm ²	2 x (0.25 ... 1.5)
• Stranded	mm ²	2 x (0.25 ... 1.5)
• AWG cables, solid or stranded	AWG	2 x (24 ... 16)

¹⁾ Analog input modules, e.g. SM 331, must be configured for four-wire measuring transducers. The analog input module may not supply current to the analog output of the 3RB24 overload relay.

²⁾ If two different conductor cross-sections are connected to one clamping point, both cross-sections must be in the range specified.

Protection equipment

Overload relays

SIRIUS 3RB2 electronic overload relays

IE3/IE4 ready 3RB24 for IO-Link for high-feature applications

3RB24 electronic overload relays (evaluation modules) for full motor protection for stand-alone installation, CLASS 5E, 10E, 20E and 30E (adjustable)

Type	3RB2483-4A.1
Features and technical specifications	
Overload protection, phase failure protection and asymmetry protection	✓
Supplied from an external source	✓ 24 V DC via IO-Link
Direct-on-line or reversing starters (star-delta (wye-delta) starting also possible) controllable via IO-Link	✓
Auxiliary contacts	✓ 1 CO and 1 NO in series
Manual and Automatic RESET	✓
Remote RESET	✓ (electrically or via IO-Link)
Four LEDs for operating and status displays	✓
TEST function and self-monitoring	✓
Internal ground-fault detection	✓
Screw or spring-loaded terminals for auxiliary, control and sensor circuits	✓
Input for thermistor (PTC) sensor circuit	✓
Analog output	✓
IO-Link-specific functions	
• Connection of direct-on-line, reversing and star-delta (wye-delta) starters to the controller via IO-Link	✓
• On-site controlling of the starter using the handheld device	✓
• Accessing process data (e.g. current values in all three phases) via IO-Link	✓
• Accessing parameterization and diagnostics data (e.g. tripped signals) via IO-Link	✓

✓ Available

Selection and ordering data

PU (UNIT, SET, M) = 1
 PS* = 1 unit
 PG = 41G



3RB2483-4AA1



3RB2483-4AC1

Size contactor	Version	Screw terminals	Spring-loaded terminals
		Article No. Price per PU	Article No. Price per PU

Evaluation modules

S00 ... S12	Monostable	3RB2483-4AA1	3RB2483-4AC1
-------------	------------	---------------------	---------------------

Notes:

- Overview of overload relays – matching contactors, see page 7/81.
- Analog input modules, e.g. SM 331, must be configured for four-wire measuring transducers. The analog input module may not supply current to the analog output of the 3RB24 relay.

Current measuring modules and related connecting cables, see page 7/137. More accessories, see page 7/138 onwards.

Protection equipment

Overload relays

SIRIUS 3RB2 electronic overload relays

Current measuring modules for 3RB22, 3RB23 and 3RB24

Overview

More information

Homepage, see www.siemens.com/sirius-control
Industry Mall, see www.siemens.com/product?3RB2

Application Manual for switching devices with IE3 and IE4 motors, see <https://support.industry.siemens.com/cs/ww/en/view/94770820>
Other manuals, see <https://support.industry.siemens.com/cs/ww/en/ps/16282/man>



SIRIUS 3RB2906 current measuring module

The current measuring modules are designed as system components for connecting to 3RB22 to 3RB24 evaluation units. Using these evaluation units the motor current is measured and the measured value sent to the evaluation unit for evaluation.

The current measuring modules in sizes up to S3 are equipped with straight-through transformers and can be snap-fitted under the evaluation units. The larger evaluation units are installed directly on the contactor or as stand-alone units.

Application

Use of SIRIUS protection devices in conjunction with IE3 and IE4 motors

Note:

For the use of current measuring modules for 3RB22, 3RB23, 3RB24 in conjunction with highly efficient IE3 and IE4 motors, please observe the information on dimensioning and configuration, see [Application Manual](#).

For more information, see [page 1/8](#).

Technical specifications

More information

Manuals, see
<https://support.industry.siemens.com/cs/ww/en/ps/16282/man>

Technical specifications, see
<https://support.industry.siemens.com/cs/ww/en/ps/16282/td>

The following technical information is intended to provide an initial overview of the various types of devices and functions.

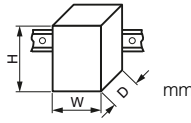



Type – Overload relays: Current measuring modules		3RB2906		3RB2956		3RB2966	
Size contactor		S00/S0	S2/S3	S6		S10/S12	
Dimensions of current measuring modules (W x H x D)		45 x 84 x 45	55 x 94 x 72	120 x 119 x 145		145 x 147 x 148	
Main circuit							
Rated insulation voltage U_i (pollution degree 3)	V	690		1 000			
Rated impulse withstand voltage U_{imp}	kV	6		8			
Rated operational voltage U_e	V	690		1 000			
Type of current		No Yes, 50/60 Hz ±5%					
• Direct current		No					
• Alternating current		Yes, 50/60 Hz ±5%					
Current setting	A	0.3 ... 3; 2.4 ... 25	10 ... 100	20 ... 200		63 ... 630	
Power loss per unit (max.)	W	0.5					
Short-circuit protection		See "Selection and ordering data", page 7/137 See Configuration Manual					
Degree of protection IP on the front according to IEC 60529		IP20 (IP00 (IP20 with box terminal/cover))					
• Screw terminals/busbar connections		IP20		IP00 (IP20 with box terminal/cover)			
• Straight-through transformers		IP20		IP20		--	
Touch protection on the front according to IEC 60529		Finger-safe for vertical touching from the front					
• Screw terminals/busbar connections		Finger-safe for vertical touching from the front		Finger-safe for vertical touching from the front (with box terminals/cover)			
• Straight-through transformers		Finger-safe for vertical touching from the front		Finger-safe for vertical touching from the front		--	
Protective separation between main and auxiliary conducting paths According to IEC 60947-1 (pollution degree 2)							
• For systems with grounded neutral point	V	690					
• For systems with ungrounded neutral point	V	600					

Protection equipment

Overload relays

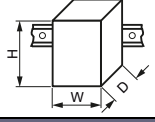
SIRIUS 3RB2 electronic overload relays

Current measuring modules for 3RB22, 3RB23 and 3RB24

Type – Overload relays: Current measuring modules		3RB2906		3RB2956		3RB2966	
Size contactor		S00/S0	S2/S3	S6		S10/S12	
Dimensions of current measuring modules (W x H x D)		45 x 84 x 45	55 x 94 x 72	120 x 119 x 145		145 x 147 x 148	
Conductor cross-sections of main circuit							
Connection type		 Screw terminals with box terminal					
Terminal screw	mm	--		4 mm Allen screw		5 mm Allen screw	
Operating devices	mm	--		4 mm Allen screw		5 mm Allen screw	
Prescribed tightening torque	Nm	--		10 ... 12		20 ... 22	
Conductor cross-sections (min./max.), one or two conductors can be connected							
• Solid or stranded	mm ²	--		With 3RT1955-4G box terminal: 2 x (max. 70), 1 x (16 ... 70)		2 x (70 ... 240), Front clamping point only: 1 x (95 ... 300)	
				With 3RT1956-4G box terminal: 2 x (max. 120), 1 x (16 ... 120)		Rear clamping point only: 1 x (120 ... 240)	
• Finely stranded without end sleeve	mm ²	--		With 3RT1955-4G box terminal: 2 x (1 x max. 50, 1 x max. 70), 1 x (10 ... 70)		2 x (50 ... 185), Front clamping point only: 1 x (70 ... 240)	
				With 3RT1956-4G box terminal: 2 x (1 x max. 95, 1 x max. 120), 1 x (10 ... 120)		Rear clamping point only: 1 x (120 ... 185)	
• Finely stranded with end sleeve (DIN 46228)	mm ²	--		With 3RT1955-4G box terminal: 2 x (1 x max. 50, 1 x max. 70), 1 x (10 ... 70)		2 x (50 ... 185), Front clamping point only: 1 x (70 ... 240)	
				With 3RT1956-4G box terminal: 2 x (1 x max. 95, 1 x max. 120), 1 x (10 ... 120)		Rear clamping point only: 1 x (120 ... 185)	
• AWG cables	AWG	--		With 3RT1955-4G box terminal: 2 x (max. 1/0), 1 x (6 ... 2/0)		2 x (2/0 ... 500 kcmil), Front clamping point only: 1 x (3/0 ... 600 kcmil)	
				With 3RT1956-4G box terminal: 2 x (max. 3/0), 1 x (6 ... 250 kcmil)		Rear clamping point only: 1 x (250 kcmil ... 500 kcmil)	
• Ribbon cables (number x width x thickness)	mm	--		With 3RT1955-4G box terminal: 2 x (6 x 15.5 x 0.8), 1 x (3 x 9 x 0.8 ... 6 x 15.5 x 0.8)		2 x (20 x 24 x 0.5), 1 x (6 x 9 x 0.8 ... 20 x 24 x 0.5)	
				With 3RT1956-4G box terminal: 2 x (10 x 15.5 x 0.8), 1 x (3 x 9 x 0.8 ... 10 x 15.5 x 0.8)			
Connection type		 Busbar connections					
Terminal screw		--		M8 x 25		M10 x 30	
Prescribed tightening torque	Nm	--		10 ... 14		14 ... 24	
Conductor cross-sections (min./max.), one or two conductors can be connected							
• Solid with cable lug	mm ²	--		16 ... 95 ¹⁾		50 ... 240 ²⁾	
• Stranded with cable lug	mm ²	--		25 ... 120 ¹⁾		70 ... 240 ²⁾	
• AWG cables, solid or stranded, with cable lug	AWG	--		4 ... 250 kcmil		2/0 ... 500 kcmil	
• With connecting bars (max. width)	mm	--		17		25	
Connection type		 Straight-through transformers					
Diameter of opening	mm	7.5	14	25		--	

¹⁾ When connecting cable lugs according to DIN 46235 with conductor cross-sections from 95 mm², the 3RT1956-4EA1 terminal cover must be used to ensure phase clearance, see page 7/138.

²⁾ When connecting cable lugs according to DIN 46234 for conductor cross-sections from 240 mm², as well as DIN 46235 for cable cross-sections from 185 mm², the 3RT1956-4EA1 terminal cover must be used to ensure phase clearance, see page 7/138.

Protection equipment

Overload relays





SIRIUS 3RB2 electronic overload relays

IE3/IE4 ready

Current measuring modules for 3RB22, 3RB23 and 3RB24

Selection and ordering data

Current measuring modules (essential accessories)

								
3RB2906-2BG1	3RB2906-2DG1	3RB2906-2JG1	3RB2956-2TG2	3RB2966-2WH2				
Size contactor	Current setting value of the inverse-time delayed overload release	Short-circuit protection with fuse, type of coordination "2", operational class gG ¹⁾	For overload relays	Article No.	Price per PU	PU (UNIT, SET, M)	PS*	PG
	A	A						

Sizes S00/S0

Devices with straight-through transformer for stand-alone installation

S00/S0	0.3 ... 3	20	3RB22 to 3RB24	3RB2906-2BG1	1	1 unit	41G
	2.4 ... 25	63		3RB2906-2DG1	1	1 unit	41G

Sizes S2/S3

Devices with straight-through transformer for stand-alone installation

S2/S3	10 ... 100	315	3RB22 to 3RB24	3RB2906-2JG1	1	1 unit	41G
-------	------------	-----	-------------------	---------------------	---	--------	-----

Size S6

Devices with busbar connection, for mounting on contactor and stand-alone installation (an appropriate connection kit with screws, spring washers and nuts is enclosed)

S6	20 ... 200	315	3RB22 to 3RB24	3RB2956-2TH2	1	1 unit	41G
----	------------	-----	-------------------	---------------------	---	--------	-----

Devices with straight-through transformer, for mounting on contactor and stand-alone installation

For mounting on S6 contactors with box terminals	20 ... 200	315	3RB22 to 3RB24	3RB2956-2TG2	1	1 unit	41G
--	------------	-----	-------------------	---------------------	---	--------	-----

Sizes S10/S12²⁾

Devices with busbar connection, for mounting on contactor and stand-alone installation (an appropriate connection kit with screws, spring washers and nuts is enclosed)

S10/S12 and size 14 (3TF68/3TF69) ²⁾	63 ... 630	800	3RB22 to 3RB24	3RB2966-2WH2	1	1 unit	41G
---	------------	-----	-------------------	---------------------	---	--------	-----

¹⁾ Maximum protection by fuse only for overload relays, type of coordination "2". For fuse values in connection with contactors, see Configuration Manual.

²⁾ For 3TF68/3TF69 contactors, direct mounting is not possible.

Note:

The connecting cable between the current measuring module and the evaluation module is not included in the scope of supply; please order separately (see "Accessories").

Accessories

Size contactor	Version		For overload relays	Article No.	Price per PU	PU (UNIT, SET, M)	PS*	PG
-------------------	---------	--	---------------------------	-------------	-----------------	-------------------------	-----	----

Connecting cables (essential accessories)

	S00 ... S3	For connection between evaluation module and current measuring module	3RB22 to 3RB24	3RB2987-2B		1	1 unit	41F
3RB2987-2D	S00 ... S12	• Length 0.5 m	3RB22 to 3RB24	3RB2987-2D		1	1 unit	41F

Additional general accessories, see page 7/138.

Protection equipment

Overload relays

SIRIUS 3RB2 electronic overload relays

Accessories for 3RB22, 3RB23, 3RB24

Overview

More information

Homepage, see www.siemens.com/sirius-control
Industry Mall, see www.siemens.com/product?3RB2

Manuals, see <https://support.industry.siemens.com/cs/ww/en/ps/16283/man>

The following optional accessories are available for the 3RB22 to 3RB24 electronic overload relays:



- Operator panel for the 3RB24 evaluation modules
- Sealable cover for the 3RB22 to 3RB24 evaluation modules
- Terminal covers for the 3RB29 current measuring modules size S6 and S10/S12
- Box terminal blocks for the 3RB29 current measuring modules size S6 and S10/S12
- Push-in lugs for screw fixing for 3RB22 to 3RB24 evaluation modules and 3RB2906 current measuring modules

Selection and ordering data

Accessories for 3RB24 overload relays

Version	For overload relays	Article No.	Price per PU	PU (UNIT, SET, M)	PS*	PG
Operator panels for evaluation modules						
	Operator panels (set)	3RB24	3RA6935-0A	1	1 unit	42F
3RA6935-0A	One set comprises: • 1 x operator panel • 1 x 3RA6936-0A enabling module • 1 x 3RA6936-0B interface cover • 1 x fixing terminal <u>Note:</u> The connecting cable between the evaluation module and the operator panel is not included in the scope of supply; please order separately.					
	Connecting cable Length 2.5 m (round), for connecting the evaluation module to the operator panel	3RB24	3UF7933-0BA00-0	1	1 unit	42J
	Enabling modules (spare part)	3RB24	3RA6936-0A	1	1 unit	42F
	Interface covers	3RB24	3RA6936-0B	1	5 units	42F

General accessories

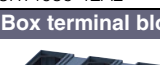
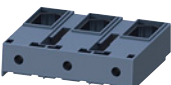
Version	Size	For overload relays	Article No.	Price per PU	PU (UNIT, SET, M)	PS*	PG
Sealable covers for evaluation modules							
	For covering the setting knobs	--	3RB22 to 3RB24	3RB2984-2	1	10 units	41F
3RB2984-2							
Terminal covers for current measuring modules							
	Covers for cable lugs and busbar connections						
	• Length 100 mm	S6	3RB2956	3RT1956-4EA1	1	1 unit	41B
	• Length 120 mm	S10/S12	3RB2966	3RT1966-4EA1	1	1 unit	41B
	Covers for box terminals						
	• Length 25 mm	S6	3RB2956	3RT1956-4EA2	1	1 unit	41B
	• Length 30 mm	S10/S12	3RB2966	3RT1966-4EA2	1	1 unit	41B
	Covers for screw terminals Between contactor and overload relay, without box terminals (1 unit required per combination)						
		S6	3RB2956	3RT1956-4EA3	1	1 unit	41B
		S10/S12	3RB2966	3RT1966-4EA3	1	1 unit	41B
3RT1956-4EA1							
3RT1956-4EA2							
3RT1956-4EA3							
Box terminal blocks for current measuring modules							
	For round and ribbon cables						
	• Up to 70 mm ²	S6 ¹⁾	3RB2956	3RT1955-4G	1	1 unit	41B
	• Up to 120 mm ²	S6	3RB2956	3RT1956-4G	1	1 unit	41B
	• Up to 240 mm ²	S10/S12	3RB2966	3RT1966-4G	1	1 unit	41B
3RT1955-4G							



¹⁾ In the scope of supply for 3RT1054-1 contactors (55 kW).

Protection equipment

Overload relays

SIRIUS 3RB2 electronic overload relays

Accessories for 3RB22, 3RB23, 3RB24

Version	Size	For overload relays	Article No.	Price per PU	PU (UNIT, SET, M)	PS*	PG
Push-in lugs for evaluation modules and current measuring modules							
	For screw fixing the evaluation modules	--	3RB22 to 3RB24	3RP1903	1	10 units	41H
3RP1903							
	For screw fixing the current measuring modules (2 units per module)	S00 ... S3	3RB2906	3RB1900-0B	100	10 units	41F
3RB1900-0B							

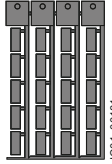
Version	Size	Color	For overload relays	Article No.	Price per PU	PU (UNIT, SET, M)	PS*	PG
Tools for opening spring-loaded terminals								
	Screwdrivers For all SIRIUS devices with spring-loaded terminals	Length approx. 200 mm, 3.0 mm x 0.5 mm	Titanium gray/black, partially insulated	Main and auxiliary circuit connection: 3RB2	3RA2908-1A	1	1 unit	41B
3RA2908-1A								
Blank labels								
	Unit labeling plates ¹⁾ For SIRIUS devices	20 mm x 7 mm	Titanium gray	3RB2	3RT2900-1SB20	100	340 units	41B
3RT2900-1SB20								
	Adhesive labels For SIRIUS devices	19 mm x 6 mm	Titanium gray	3RB2	3RT2900-1SB60	100	3 060 units	41B

¹⁾ PC labeling system for individual inscription of unit labeling plates available from: murrplastik Systemtechnik GmbH (see page 16/18).

Protection equipment

Notes

7