

### Specification

Code:460-6205

Nominal Voltage	12V	
Nominal Capacity(10HR)	55.0AH	
Dimension	Length	277±3mm (10.9 inches)
	Width	106±2mm (4.17 inches)
	Container Height	222±3mm (8.74 inches)
	Total Height (with Terminal)	222±3mm (8.74 inches)
Approx Weight	Approx 17.3 Kg (38.1 lbs)	
Terminal	T6	
Container Material	ABS	
Rated Capacity	58.2AH/2.91A	(20hr, 1.80V/cell, 25°C/77°F)
	55.0AH/5.5A	(10hr, 1.80V/cell, 25°C/77°F)
	48.2AH/9.64A	(5hr, 1.75V/cell, 25°C/77°F)
	43.5AH/14.5A	(3hr, 1.75V/cell, 25°C/77°F)
	35.9AH/35.9A	(1hr, 1.67V/cell, 25°C/77°F)
Max. Discharge Current	550A (5s)	
Internal Resistance	Approx 6.5mΩ	
Operating Temp. Range	Discharge	-15~50°C (5~122°F)
	Charge	0~40°C (32~104°F)
	Storage	-15~40°C (5~104°F)
Nominal Operating Temp. Range	25±3°C (77±5°F)	
Cycle Use	Initial Charging Current less than 16.5A. Voltage	
	14.4V~15.0V at 25°C(77°F)Temp. Coefficient -30mV/°C	
Standby Use	No limit on Initial Charging Current Voltage	
	13.5V~13.8V at 25°C(77°F)Temp. Coefficient -20mV/°C	
Capacity affected by Temperature	40°C (104°F)	103%
	25°C (77°F)	100%
	0°C (32°F)	86%
Self Discharge	CT series batteries may be stored for up to 6 months at 25°C(77°F) and then a freshening charge is required. For higher temperatures the time interval will be shorter.	

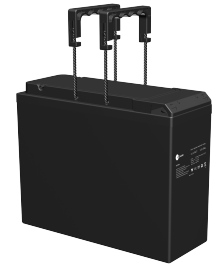

### Applications

- ◆ For standard 19 inches or 23 inches power cabinets
- ◆ Network connection equipment of communication system
- ◆ Power system of special network or local area network
- ◆ UPS, standby power supply
- ◆ Power station systems
- ◆ Railway and marine systems



### Constant Current Discharge (Amperes) at 25 °C (77°F)

F.V/Time	10min	15min	20min	30min	45min	1h	2h	3h	4h	5h	6h	8h	10h	20h
1.85V/cell	87.8	76.2	65.9	51.7	39.4	31.7	18.3	13.3	10.7	8.97	7.86	6.30	5.26	2.79
1.80V/cell	101.3	86.0	73.0	56.6	42.5	33.9	19.7	14.3	11.3	9.52	8.29	6.62	5.50	2.91
1.75V/cell	111.9	93.1	78.9	59.5	43.9	34.9	20.1	14.5	11.5	9.64	8.39	6.70	5.56	2.93
1.70V/cell	118.1	98.3	82.0	61.2	44.9	35.5	20.4	14.7	11.6	9.73	8.46	6.75	5.60	2.95
1.67V/cell	123.4	102.1	84.5	62.2	45.5	35.9	20.5	14.8	11.7	9.82	8.53	6.81	5.64	2.97
1.60V/cell	128.7	104.9	86.3	63.5	46.1	36.4	20.7	14.9	11.8	9.90	8.61	6.86	5.68	2.99

### Constant Power Discharge (Watts/cell) at 25 °C (77°F)

F.V/Time	10min	15min	20min	30min	45min	1h	2h	3h	4h	5h	6h	8h	10h	20h
1.85V/cell	167.2	146.5	127.8	100.9	77.2	62.4	36.3	26.5	21.3	17.9	15.8	12.7	10.6	5.63
1.80V/cell	191.6	164.4	140.6	109.9	82.9	66.5	38.9	28.3	22.6	19.0	16.6	13.3	11.1	5.87
1.75V/cell	210.0	176.5	151.1	114.9	85.5	68.3	39.6	28.8	22.9	19.2	16.8	13.4	11.2	5.90
1.70V/cell	218.8	184.6	155.6	117.3	86.7	69.2	39.9	28.9	23.0	19.3	16.9	13.5	11.2	5.93
1.67V/cell	225.1	188.8	158.3	117.8	87.2	69.3	40.0	29.0	23.1	19.4	17.0	13.6	11.3	5.95
1.60V/cell	229.8	190.9	159.6	119.0	87.5	69.8	40.2	29.1	23.2	19.5	17.1	13.7	11.3	5.98

Specifications subject to change without notice.

## Dimensions

### T6 Terminal

Unit: mm

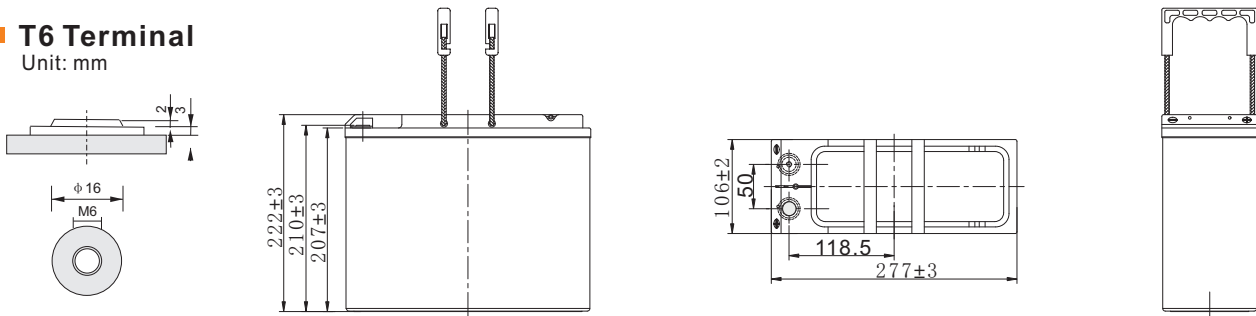

## Discharge Characteristics

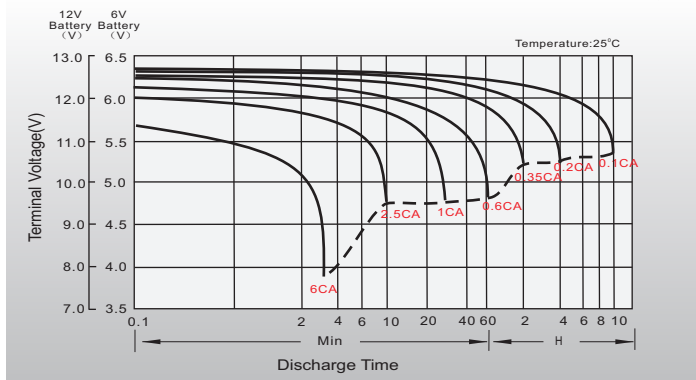

## Float Charging Characteristics

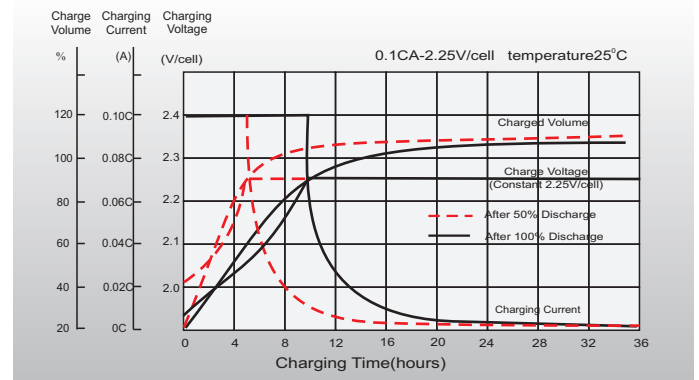

## Temperature Effects in Relation to Battery Capacity

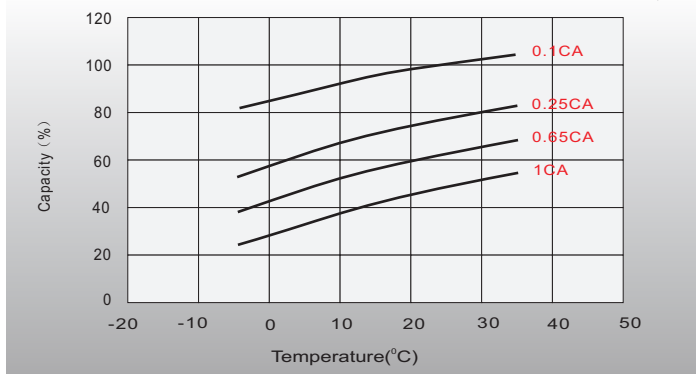

## Effect of Temperature on Long Term Float Life

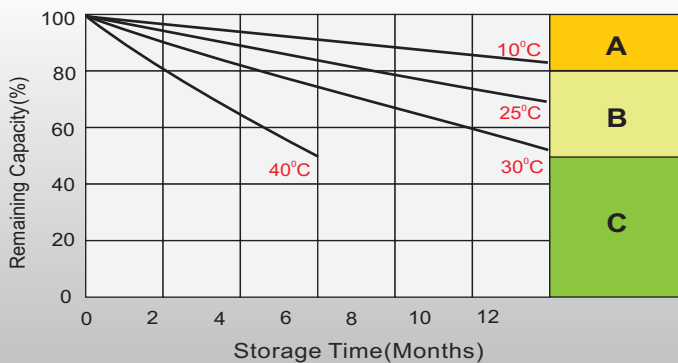
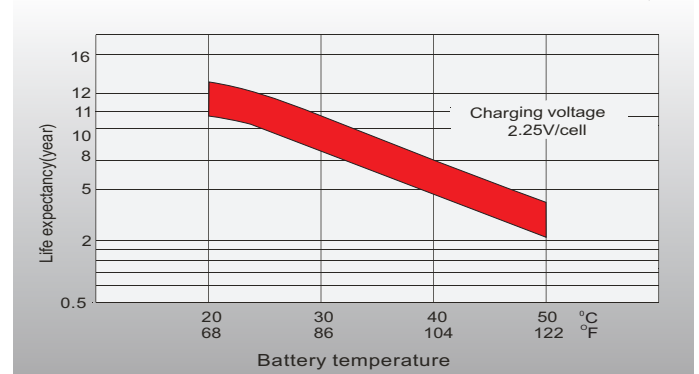

## Self Discharge Characteristics

- A** No supplementary charge required  
(Carry out supplementary charge before use if 100% capacity is required.)
- B** Supplementary charge required before use. Optional charging way as below:
  1. Charged for above 3 days at limited current 0.25CA and constant volatge 2.25V/cell.
  2. Charged for above 20hours at limited current 0.25CA and constant volatge 2.45V/cell.
  3. Charged for 8~10hours at limited current 0.05CA .
- C** Supplementary charge may often fail to recover the capacity.  
The battery should never be left standing till this is reached.

## Sales Office

### Finland and Baltic countries

Celltech Oy  
Höyläämötie 11 A, 00380 Helsinki, Finland  
TEL: +358 (0) 207 999 640  
E-mail: info@celltech.fi  
www.celltech.fi

### Denmark

Celltech A/S  
Lejrvej 25, 3500 Vaerloese, Denmark  
TEL: +45 7025 2201  
E-mail: info@celltech.dk  
www.celltech.dk

### Norway

Staubo Elektro-Maskin AS  
Bjoernerudveien 12 C, 1266 Oslo, Norway  
TEL: +47 22 75 35 00  
E-Mail: post@staubo.no  
www.staubo.no