

GinoLED Flex Diffuse Side Tunable White

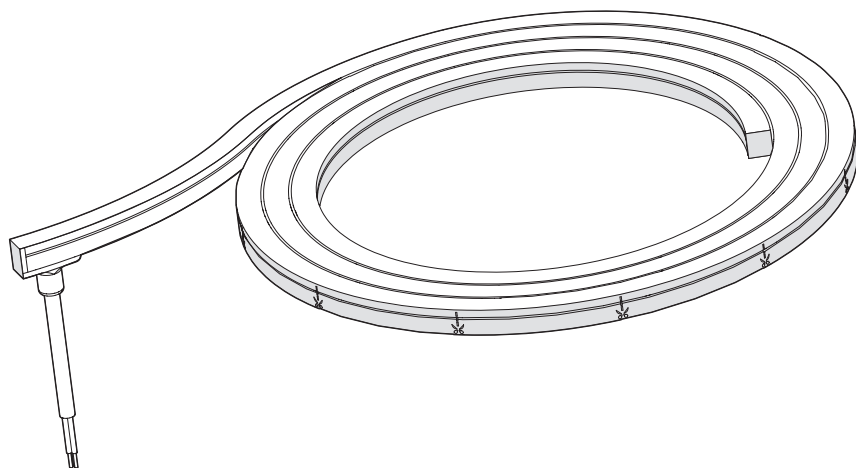

OSRAM

GinoLED Flex Diffuse Side Tunable White

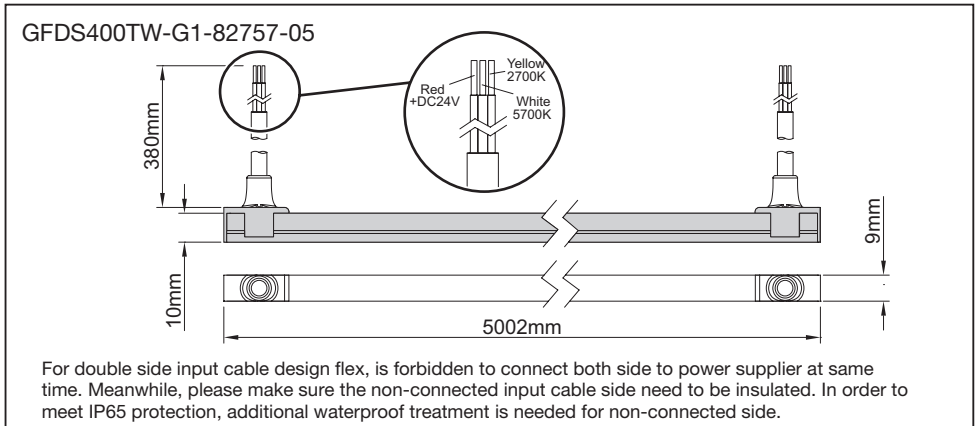
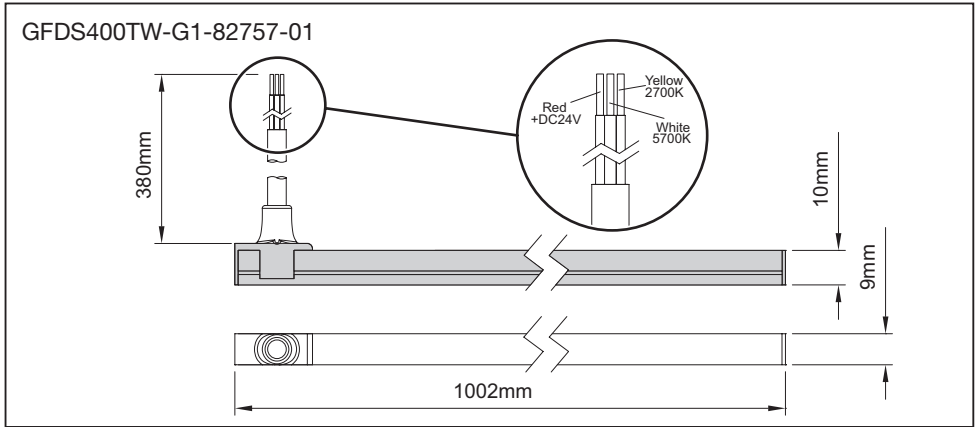

Specification

Product	Color	Voltage [V DC]*	Current/m [mA]*	Power/m [W]*	Lumen/m [lm]*	Power/reel [W]	Lumen/ reel [lm]*	CRI	Operable length [mm]	Beam Angle [°]
GFDS400TW-G1-82757-01	2700K	24	250	6	400	6	400	80	1002	110
	5700K	24	250	6	420	6	420	80		
GFDS400TW-G1-82757-05	2700K	24	1125	6	400	27	1850	80	5002	110
	5700K	24	1125	6	420	27	1950	80		

Due to the special conditions of the manufacturing processes of LED the typical data of technical parameters can only reflect statistical figures and do not necessarily correspond to the actual parameters of each single product which could differ from the typical data.

- * 1. Testing based on $t_p=35^{\circ}\text{C}$, one-meter data, tolerance of lumen flux is $\pm 10\%$.
- 2. Tolerance of measurements for the color rendering Ra is ± 2 ;

Cut Method

1. Check the cut point on flex body.

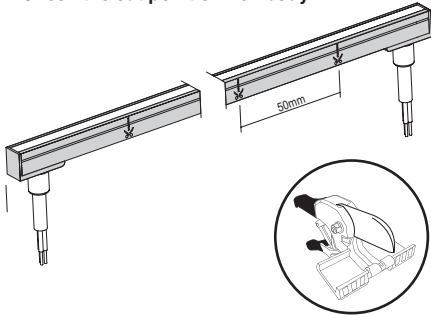

Recommended to use professional scissors which is only single blade to cut flex, other type scissors may damage flex inner LEDs.

2. Vertical 90-degree cut flex by the center line of the scissors on the red cut centerline.

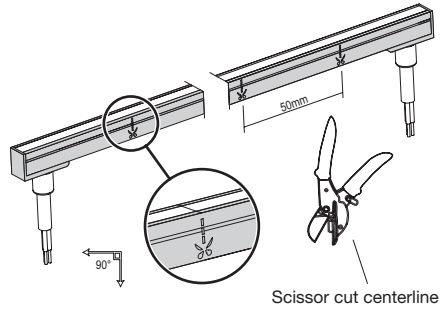

3. Correct cut example.

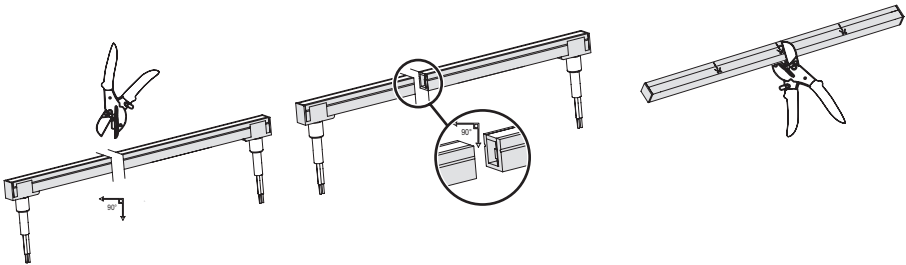

Note: Keep vertical 90-degree cutting, please follow the cut direction as picture shows, and make sure the light surface keep on the side when cutting.

Incorrect cut example.

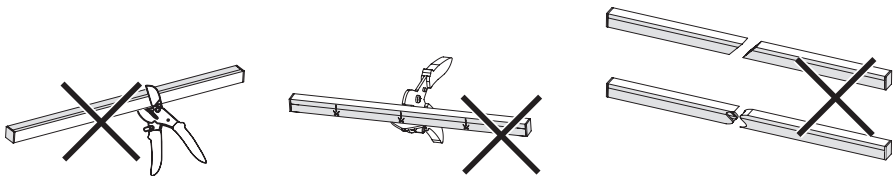

Cutting can only be made at the printed cutting line

The cutting surface must be flush and smooth.
WARNING: The above mishandling will damage the light.

GinoLED Flex Diffuse Side Tunable White

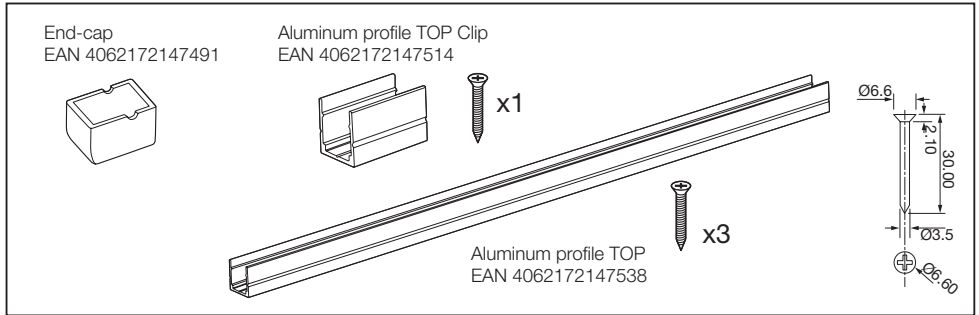

1. Wires input at both ends.

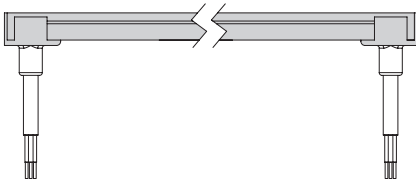

Wiring input cable, and make sure another side isolation.

2. Cut the flex to the required size.

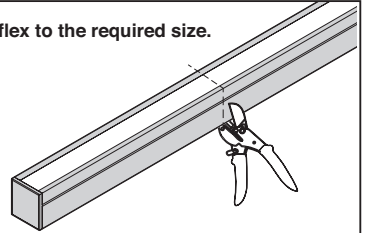

The minimum cutting unit is subject to the label of the flex. Before the strip cut, only one end input is needed.

3. First fill half of the end cap with glue, then put it on the end of strip light.

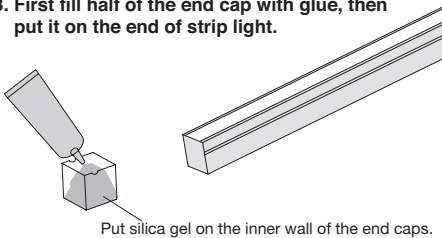

Glue volume is 1/3 to 1/2 of the plug.

4. Wipe the glue around and the tail side of the end caps, then push the end caps to the end side of the flex.

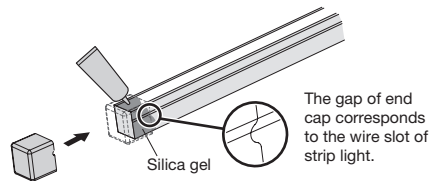

5. Push the end caps into the flex.

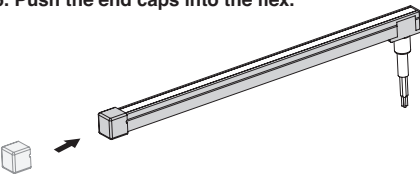

Put the flex in a flat surface and keep 30 mins after inject glue, and do the next step engineering operation until the end caps is dry.

6. After cutting, put the end plug to the strip and then both ends could be input.

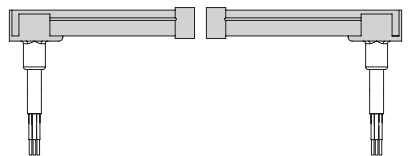

Installation Notice

light Profile

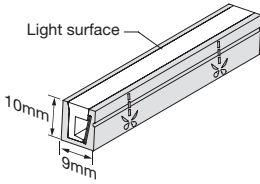

Bending Direction

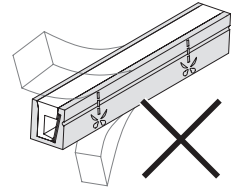
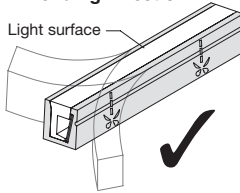

Correct Bending Way



Face to the light surface
fold the strip, the
minimum bending
diameter is 120mm

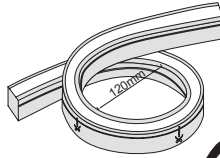

Light surface upwards, the
strip is bendable to right or
left naturally, the minimum
bending diameter is 120mm

Incorrect Bending Way

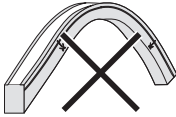

Face to the side surface,
(as the picture shows)
Do not bend downward to
damage the strip.

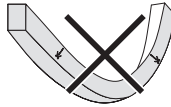

Face to the side surface,
(as the picture shows)
Do not bend upward to
damage the strip.



(as the picture shows)
please do not twist the
strip, or it will be damaged.

Installation Way

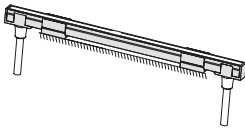

Straight line mounting method

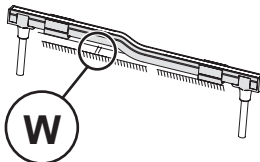

Horizontal S-Type installation

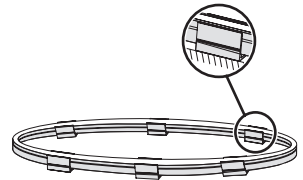

Flat round mounting

If the flex is mounted with clips by vertical directly in a straight line, recommended to use track accessory.
Recommend to use 4 pcs Clip per meter of flex to ensure the installation robust enough.

Schematic Diagram

1. When install the flex, the installation operation is carried out simultaneously from both ends, and it is forbidden to start installing in one direction.

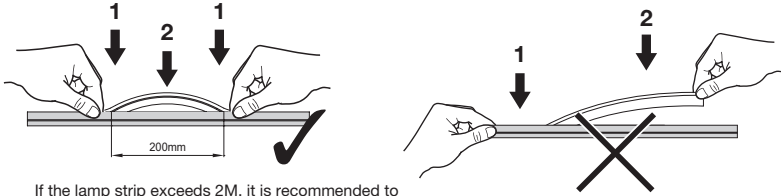

If the lamp strip exceeds 2M, it is recommended to install it horizontally with 2 people.



2. The application tool is handled carefully when disassembling, and it is forbidden to pull the flex directly out.

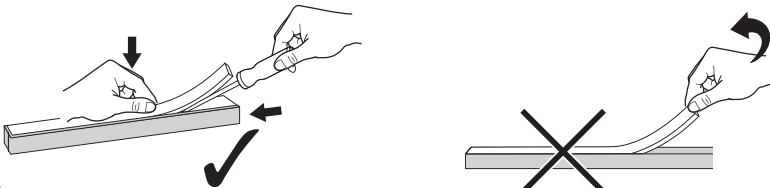

If the strip exceeds 2M, it is recommended to remove it horizontally with 2 people.

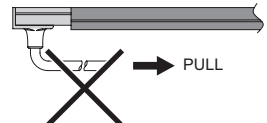
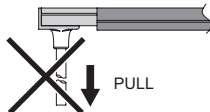
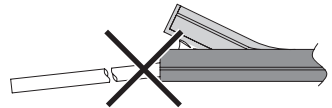
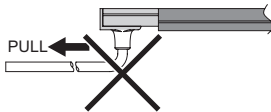
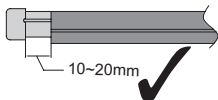
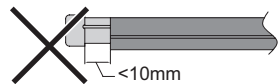
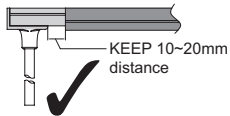

Wiring Diagram

Turn off the power supply before wiring.

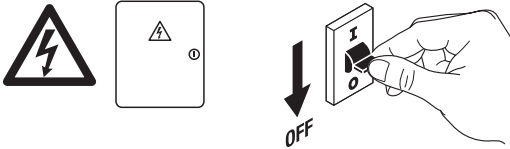

Connect wire mode for dimming.

A. External waterproof connectors make the strip waterproof.

Suggest customer base on actual application to choose suitable connector type, OSRAM standard products not include connector. Below example shows the IP rating application connector suggestion.

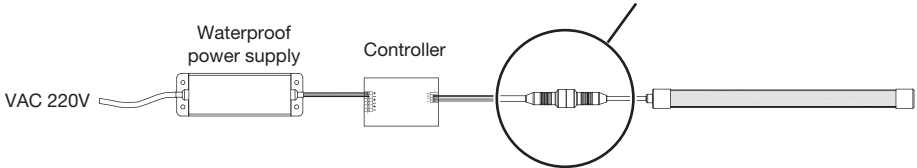

Wire colors	Red	Yellow	White
Corresponding color temperature	+DC24V	2700K	5700K

B. External waterproof boxes make the strip waterproof.

Suggest customer base on actual application to choose suitable connector type, OSRAM standard products not include connector. Below example shows the IP rating application connector suggestion.

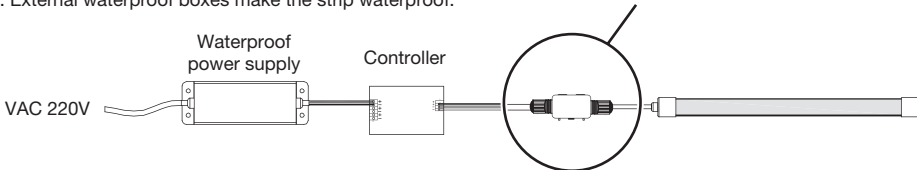

Wire colors	Red	Yellow	White
Corresponding color temperature	+DC24V	2700K	5700K

- $L_N \leq 5m$
- $L_B \leq 5m$

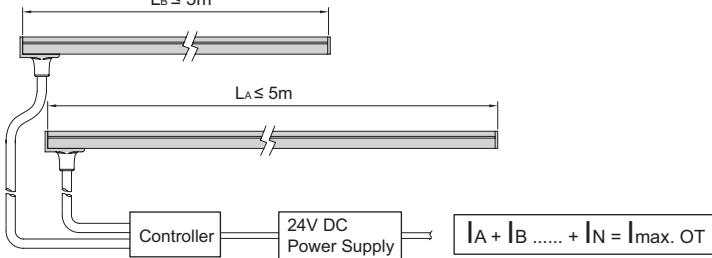

Safety Information

- The LED module itself and all its components must not be mechanically stressed.
- Assembly must not damage or destroy conducting paths on the circuit board.

The LED module incorporates no protection against short circuits, overload or overheating.
In order to drive OSRAM LED-Modules safely, it is absolutely necessary to operate them with an electronically stabilized power supply protecting against short circuits, overload and overheating.

For dimming applications attention should be paid to specific references in "OPTOTRONIC® Technical Guide".

To also ease the luminaire/installation approval, electronic control gear for LED or LED modules must carry the CE mark.

In Europe the declarations of conformity must include the following standards:
CE: EN 61347-2-13, EN 55015, EN 61547 and EN 61000-3-2.

Also check for the mark of an independent authorized certification institute.

Please see the relevant application guides for more detailed information.

When using power supplies other than OPTOTRONIC® the following basic safety features are required, in addition to any other application specific concerns and local safety codes.

OSRAM OPTOTRONIC® electronic control gear complies with all relevant standards and guarantees safe operation.

- To avoid mechanical damage to the connecting cables, the module should be attached securely to the fixture. Heavy vibration should be avoided.
- Installation of LED modules with (power supplies) needs to be made with regard to all applicable electrical and safety standards. Only qualified personnel should be allowed to perform installation.
- The module net weight of is GFDS400TW-G1-82757-01: 120g/M / GFDS400TW-G1-82757-05: 550g/M
- Please ensure that the power supply is of adequate power to operate the total load.
- GFDS400TW needs to connect with constant voltage DC driver which must has stable constant current (+/-10% tolerance suggested) output.
- Electrical contact is achieved with the contact cables.
- The design of the housing should be according to the IP standards in the application.
- Pay attention to standard ESD precautions when installing the module.
- If surge protection structure not within power supplier, a lightning protector should be needed additionally for outdoor application.
- t_C Max. 65°C, higher t_C application is not recommended. t_p in remark are the same point with t_C .
- t_C value should be measured on the silicon tube directly above the t_C point on flex, (As shown in the figure), t_C point was marked on the flex only as reference point.

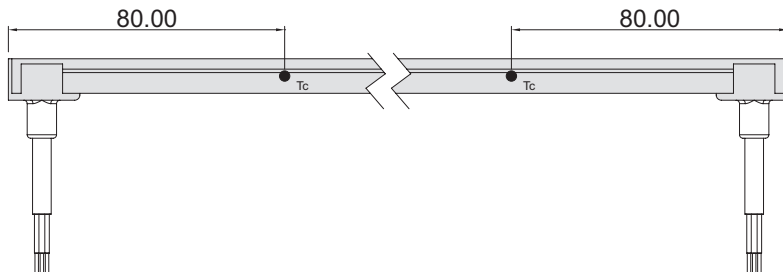

IP65



C10449057
G15081857
2020-04-22

OSRAM GmbH
Berliner Allee 65
86153 Augsburg
Germany
www.osram.com