

EMSKV 32 EMV-S

EMC-cable gland, brass nickel-plated with short thread, M32

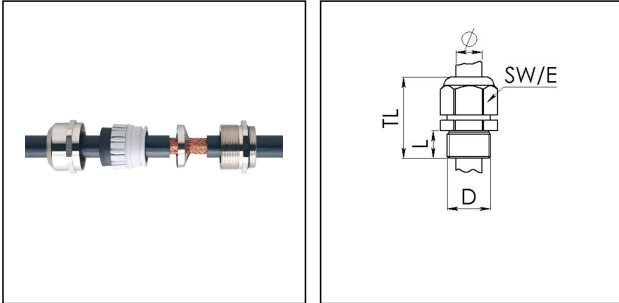

Products may differ in size, colour and appearance to those shown. If you require further information or customisation, please contact us directly.



Material cable gland	Brass nickel-plated
Material sealing gasket	EPDM
Material clamping cage	Polyamide
Material earthing insert	Stainless steel 1.4310
Temp. range min	-40 °C
Temp. range max	100 °C
Protection class	IP68 (5 bar 30 min), IP69
Thread type	M
Ø Connection thread D	32
Lead	1,5
Length screw-in thread L	8 mm
Ø cable diameter min	13 mm
Ø cable diameter max	21 mm
Cable Ø shield external	11 mm - 19 mm
Key width SW	36 mm
Collar diameter (E)	40 mm
Total length TL	36 mm - 44 mm
Type of cable anchorage	A
Install. torques cap nut	20 N m
Install. torques fitting	20 N m
Impact category	6
Surface	Nickel-plated
Order no. nickel-plated	10102277
Type	EMSKV 32 EMV-S
Packing unit	25

Your Contact:

WISKA Hoppmann GmbH

Kisdorfer Weg 28 · 24568 Kaltenkirchen · Germany

☎ +49-4191-508-0 · 📠 +49-4191-508-209

contact@wiska.de · www.wiska.com

ETIM-Classification

EC000441

Recommended accessories

RDE 32	10062186
EMMU-EMV 32	10063214
BS 21	10064014

26.10.2020

Your Contact:

WISKA Hoppmann GmbH

Kisdorfer Weg 28 · 24568 Kaltenkirchen · Germany

 +49-4191-508-0 ·  +49-4191-508-209

contact@wiska.de · www.wiska.com



Your Contact:

WISKA Hoppmann GmbH

Kisdorfer Weg 28 · 24568 Kaltenkirchen · Germany

☎ +49-4191-508-0 · 📠 +49-4191-508-209

contact@wiska.de · www.wiska.com