

## SKV 29

Cable gland, polyamide, Pg 29, RAL 7035

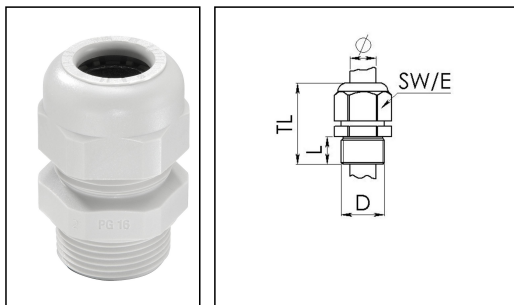

Products may differ in size, colour and appearance to those shown. If you require further information or customisation, please contact us directly.



<b>Material cable gland</b>	Polyamide
<b>Material sealing gasket</b>	EPDM
<b>Temp. range min</b>	-40 °C
<b>Temp. range max</b>	100 °C
<b>Protection class</b>	IP68 (5 bar 30 min)
<b>Thread type</b>	PG
<b>Ø Connection thread D</b>	29
<b>Length screw-in thread L</b>	12 mm
<b>Ø cable diameter min</b>	16 mm
<b>Ø cable diameter max</b>	25 mm
<b>Key width SW</b>	42 mm
<b>Collar diameter (E)</b>	46 mm
<b>Total length TL</b>	47 mm - 56 mm
<b>Glow wire test</b>	750 °C
<b>Type of cable anchorage</b>	A
<b>Product Color</b>	RAL 7035
<b>Order no. RAL 7035</b>	10066406
<b>Type</b>	SKV 29
<b>Packing unit</b>	20
<b>ETIM-Classification</b>	EC000441

### Recommended accessories

<b>MUG 29</b>	10060676
---------------	----------

Your Contact:

**WISKA Hoppmann GmbH**

Kisdorfer Weg 28 · 24568 Kaltenkirchen · Germany

☎ +49-4191-508-0 · 📠 +49-4191-508-209

contact@wiska.de · www.wiska.com

**ADR 29**

10061425

**BS 25**

10064015

03.02.2021

Your Contact:

**WISKA Hoppmann GmbH**

Kisdorfer Weg 28 · 24568 Kaltenkirchen · Germany

☎ +49-4191-508-0 · 📠 +49-4191-508-209

contact@wiska.de · www.wiska.com



Your Contact:

**WISKA Hoppmann GmbH**

Kisdorfer Weg 28 · 24568 Kaltenkirchen · Germany

☎ +49-4191-508-0 · 📠 +49-4191-508-209

contact@wiska.de · www.wiska.com