



TIEMME

COLLETTORI LINEARI Linear manifolds

Serie 1912-1922

Collettori lineari componibili con attacchi 1/2"x16 per tubi rame, tubo PE-X e tubo multistrato.

Disponibile con mandata da 3/4" o 1".

Modular linear manifolds with connections 1/2"x16 for copper, PE-X and multilayer pipes. Available with delivery size 3/4" or 1".

I collettori di distribuzione lineari "Serie 1900" sono generalmente utilizzati nelle reti di distribuzione di acqua calda e fredda. Grazie alla loro configurazione permettono l'alimentazione in parallelo delle utenze per acqua calda e/o fredda riducendo al minimo le perdite di carico. Sono inoltre idonei per l'utilizzo in sistemi a pannelli solari.

I collettori sono prodotti in conformità alle normative in materia e sono certificati relativamente alla composizione chimica dei materiali impiegati ed a livello dimensionale.

The distribution linear manifolds "Series 1900" are typically used for hot and cold water distribution. Due to the configuration they may be used to distribute cold/hot water in parallel reducing at minimum the pressure drop. The manifolds are also suitable to be used in solar panel systems. The manifolds are produced according to the relevant rules and are certified for material chemical composition and dimensional request.



Per la gamma completa vedere il catalogo / For complete range see catalogue

Caratteristiche Tecniche

Temperatura max di esercizio: 200°C
Temperatura min di esercizio: -20°C
Pressione max di esercizio: 16 bar (10 bar con vapore)
Filettature: femmina ISO 7/1 cilindrico
maschio ISO 7/1 conico

Technical Features

Maximum temperature: 200°C
Minimum temperature: -20°C
Maximum operating pressure: 16 bar (10 bar for steam applications)
Threads: female ISO 7/1 cylindrical
male ISO 7/1 conical

Descrizione	Materiale	Trattamento
Corpo	Ottone CW617N - EN12165	-

Description	Material	Treatment
Body	CW617N-EN12165 brass	-

Certificazioni / Certifications



TIEMME Raccorderie S.p.A. si riserva di apportare modifiche in qualsiasi momento senza preavviso. TIEMME Raccorderie S.p.A. reserves the right to modify contents in any time without prior advise. È vietata qualsiasi forma di riproduzione, se non autorizzata. Is forbidden any reproduction unless under TIEMME autorization



TIEMME Raccorderie S.p.A.
Via Cavallera 6/A (Loc. Barco) - 25045 Castegnato (Bs) - Italy
Tel +39 030 2142211 R.A. - Fax +39 030 2142206
info@tiemme.com - www.tiemme.com





TIEMME

COLLETTORI LINEARI Linear manifolds

Serie 1912-1922



Tabella dimensioni / *Sizes table*

Size	Vie/ Ways	A	B	C	D	E	F	G	H	I	Ch.	Codice/ Code
3/4"	2	93,5	3/4"	16,5	16,5	1/2"	16,2	36	27,0	30,5	32	1912G050402
	3	129,5	3/4"	16,5	16,5	1/2"	16,2	36	27,0	30,5	32	1913G050403
	4	165,5	3/4"	16,5	16,5	1/2"	16,2	36	27,0	30,5	32	1914G050404
	5	201,5	3/4"	16,5	16,5	1/2"	16,2	36	27,0	30,5	32	1915G050405
1"	2	94,5	1"	17,0	17,0	1/2"	16,2	36	27,5	31,0	38	1922G060402
	3	130,5	1"	17,0	17,0	1/2"	16,2	36	27,5	31,0	38	1923G060403
	4	166,5	1"	17,0	17,0	1/2"	16,2	36	27,5	31,0	38	1924G060404
	5	202,5	1"	17,0	17,0	1/2"	16,2	36	27,5	31,0	38	1925G060405

Guida alle connessioni / *Fitting guide*

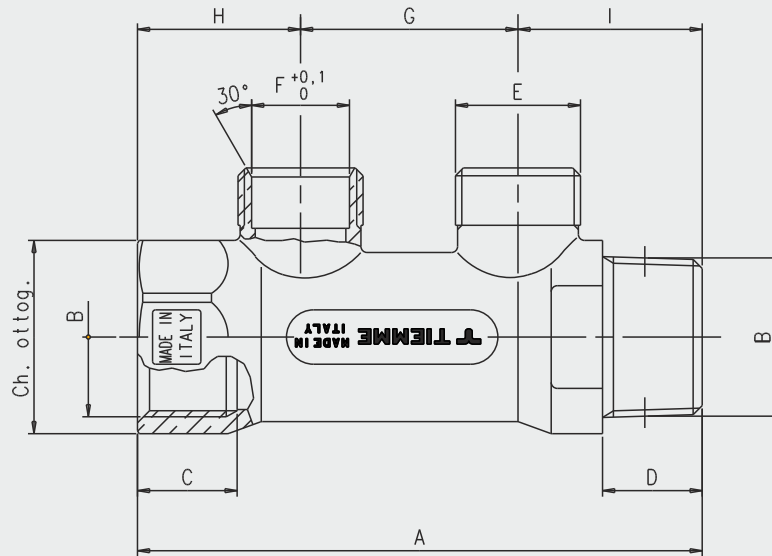
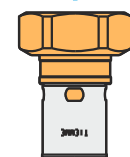
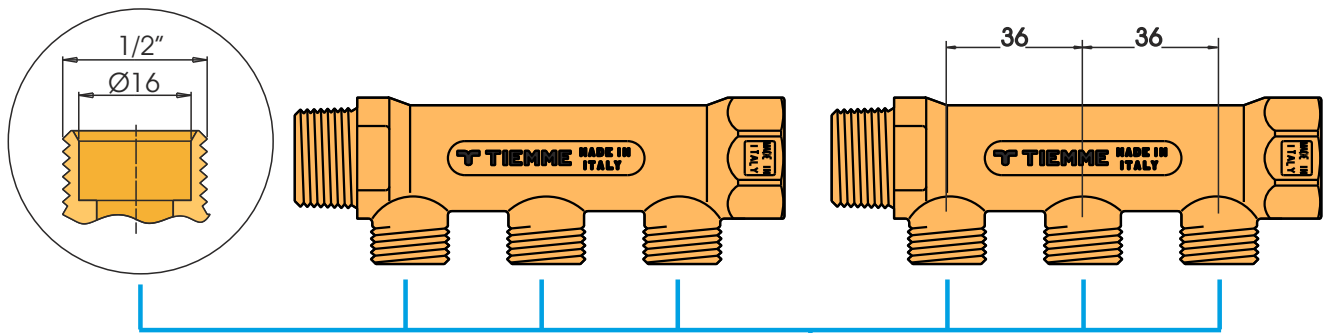

Art. 1716
Per tubo Pe-x
For Pe-x pipe

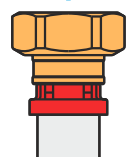

Art. 1668
Per tubo multistrato
For multilayer pipe



Art. 1635
Per tubo multistrato
For multilayer pipe



Art. 1240
Per tubo rame
For copper pipe

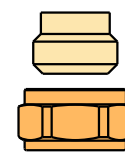

Art. 1233
Art. 1235
Per tubo rame
For copper pipe

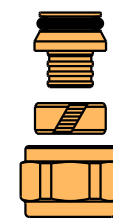

Art. 1435
Per tubo Pe-x
For Pe-x pipe

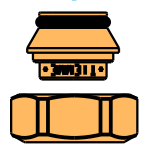

Art. 1879G0004
Tappo
Cap

TIEMME Raccorderie S.p.A. si riserva di apportare modifiche in qualsiasi momento senza preavviso.
TIEMME Raccorderie S.p.A. reserves the right to modify contents in any time without prior advise.
È vietata qualsiasi forma di riproduzione, se non autorizzata.
is forbidden any reproduction unless under TIEMME autorization



TIEMME Raccorderie S.p.A.
Via Cavallera 6/A (Loc. Barco) - 25045 Castegnato (Bs) - Italy
Tel +39 030 2142211 R.A. - Fax +39 030 2142206
info@tiemme.com - www.tiemme.com





TIEMME

COLLETTORI LINEARI Linear manifolds

Serie 1912-1922

Cassette utilizzabili
Boxes used

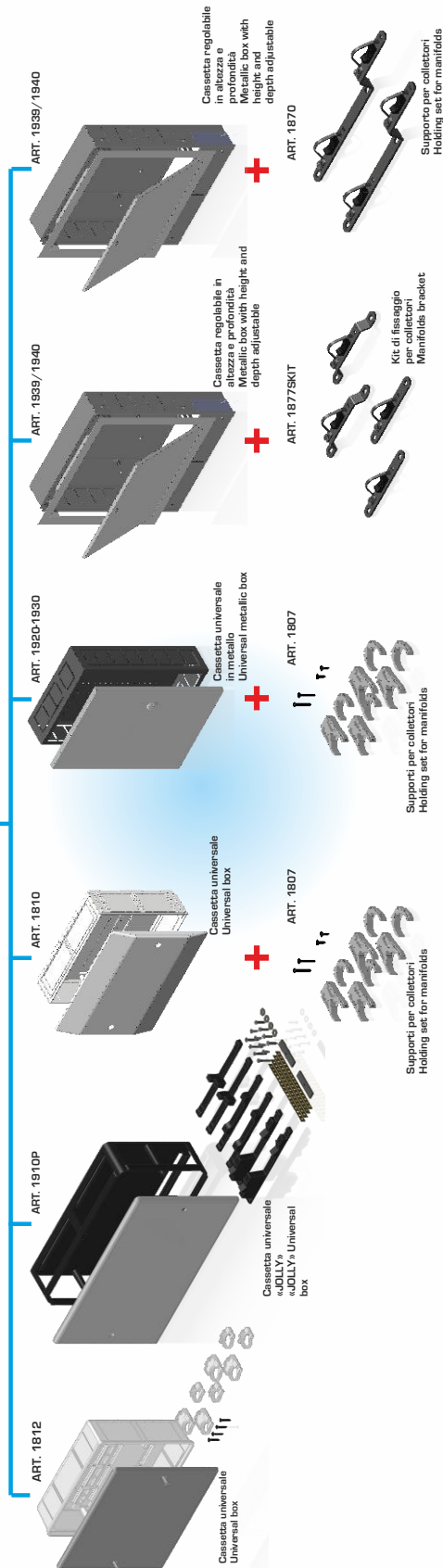

TIEMME Raccorderie S.p.A. si riserva di apportare modifiche in qualsiasi momento senza preavviso.
TIEMME Raccorderie S.p.A. reserves the right to modify contents in any time without prior advise.
È vietata qualsiasi forma di riproduzione, se non autorizzata.
is forbidden any reproduction unless under TIEMME autorization



TIEMME Raccorderie S.p.A.
Via Cavallera 6/A (Loc. Barco) - 25045 Castegnato (Bs) - Italy
Tel +39 030 2142211 R.A. - Fax +39 030 2142206
info@tiemme.com - www.tiemme.com

