



Twinny

332TSW 1xTL5-28W/830 HFS O TW3

Twinny - 1 pc - TL5 - 28 W - 830 warm white - HF Standard - Opal

Twinny is a versatile enclosed luminaire for surface or semi-recessed mounting in areas requiring IP44 protection. It has a slim, clean design with translucent edges to create an impression of brightness. Twinny is available in 1- and 2-lamp TL-D and TL5 versions with prismatic or opal cover and optional internal reflectors (wide-beam, narrow-beam and asymmetric) for improved performance. It offers easy access for maintenance.

Product data

General Information	
Number of light sources	1 pc
Lamp family code	TL5 [TL5]
Lamp power	28 W
Light source color	830 warm white
Kombipack	Lamp(s) included
Compensation circuit	-
Gear	HF Standard
Optic type	-
Optical cover/lens type	Opal
Emergency lighting	-
Feed-through wiring	Feed-through wiring 3-phase
Cable	-
Product family code	332TSW [Twinny]

Operating and Electrical	
Input Voltage	220 to 240 V

Mechanical and Housing	
Fixation point length distance (Nom)	1121 mm
Overall length	1212 mm

Approval and Application	
Ingress protection code	IP44 [Wire-protected, splash-proof]

Product Data	
Full product code	641814704117800
Order product name	332TSW 1xTL5-28W/830 HFS O TW3
EAN/UPC - Product	6418147041178
Order code	910820022412
Numerator - Quantity Per Pack	1
Numerator - Packs per outer box	1
Material Nr. (12NC)	910820022412
Net Weight (Piece)	3.400 kg

Twinnny



Dimensional drawing

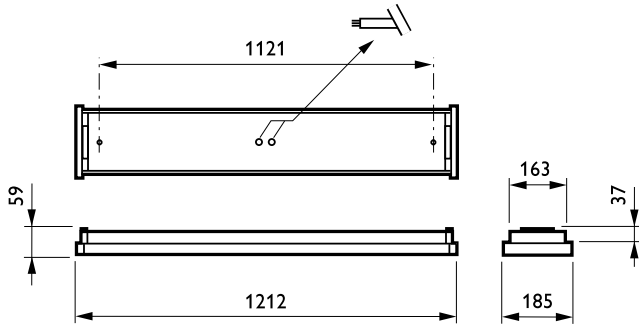

Twinnny 331TSW

