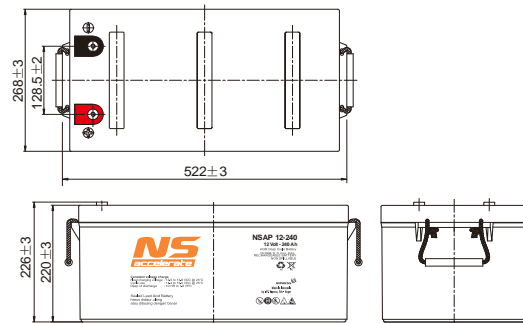
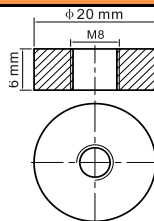

TECHNICAL SHEET
NSAP 12-240

NSAP 12-240 is a top terminal battery with AGM technology is specially designed for Telecommunication use with over 12 years design life at 25 °C. NSAP type also comply with IEC 60896-21/22, standard battery for Stationary Lead Acid batteries. The adoption of centralized venting system make sure the battery can be installed in any location and guarantees high security and reliability.

VIEW

DIMENSIONS

TERMINAL SIZE

WEIGHT AND DIMENSION

Battery Weight	: Approximate	72	Kg
Length	: 522 ± 3		mm
Width	: 268 ± 3		mm
Height	: 220 ± 3		mm
Total Height	: 226 ± 3		mm

PERFORMANCE

Nominal Voltage	: 12 V
Capacity 10 h (C ₁₀)	: 240 Ah
Max Discharge Current	: 2400 A (5 sec)
Internal Resistance	: Approx. 2.5 m Ω
Normal Operating Temp. Range	: 25°C ± 5°C
Float charging Voltage	: 13.5 to 13.8 VDC/unit@25°C
Recommended maximum charging current limit	: 70 A
Equalization and Cycle Service	: 14.4 to 15.0 VDC/unit@25°C
Self Discharge	: Self-discharge ratio less than 3% per month at 25°C. Please charge batteries before using.

COVER AND CONTAINER

Material	: A.B.S. UL94-HB, UL94-V0 Optional.
Type	: NSAP 12-240
Terminal	: F10

OTHER

Operating Temperature Range	-15°C to 50°C	Discharge
	0°C to 40°C	Charge
	-15°C to 40°C	Storage

Discharge Characteristic Curve

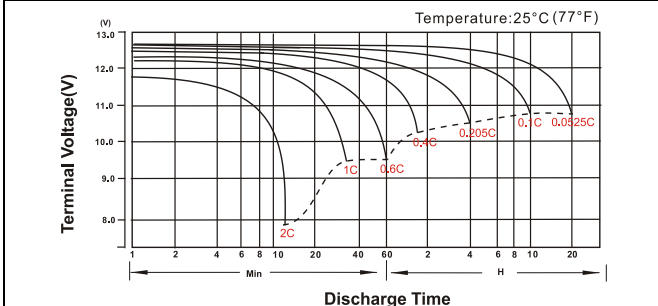

Float Charging Characteristics

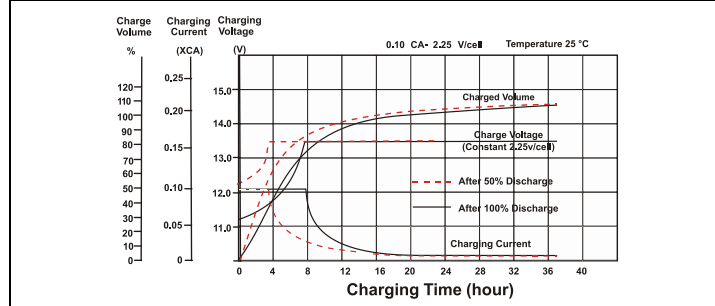

Temperature Effects in Relation of Battery Capacity

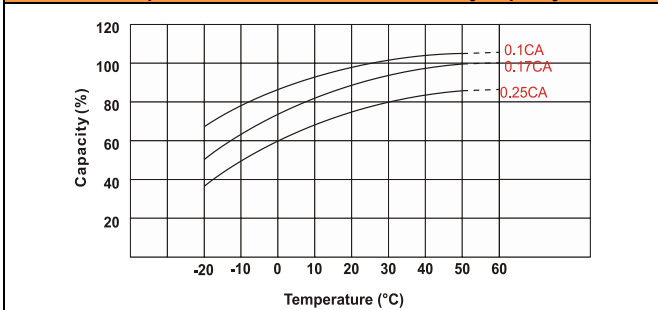

Effect of Temperature on Long Term Float Life

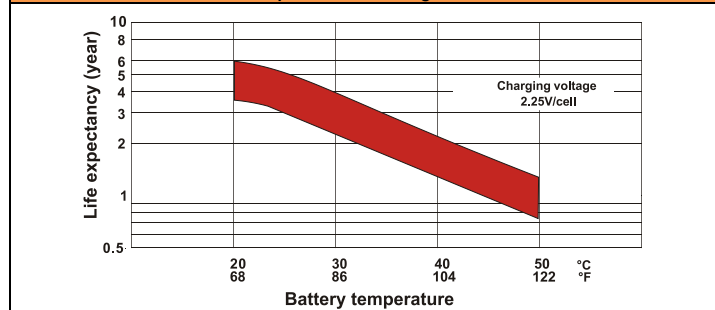

Graphic Life Cycle

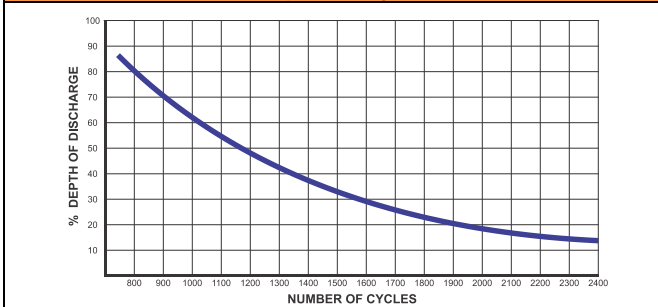

Self Discharge Characteristics

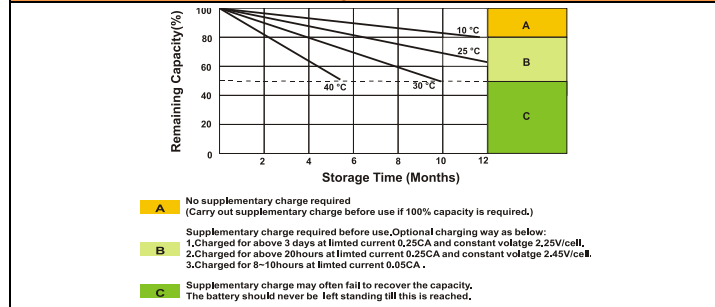

Constant Current Discharge (Amperes) at 25 °C

F.V/Time	15min	20min	30min	45min	1h	2h	3h	4h	5h	6h	8h	10h	20h
1.85V/cell	286.1	239.3	190.2	143.9	117.9	75.1	59.4	48.5	39.1	34.0	27.6	23.6	12.9
1.80V/cell	345.7	282.9	224.4	167.4	132.0	81.9	63.9	51.8	42.0	36.5	29.3	24.0	13.0
1.75V/cell	377.6	304.3	233.0	173.7	138.1	85.0	65.1	52.9	43.0	37.5	29.8	25.3	13.1
1.70V/cell	403.1	319.8	242.5	180.7	142.5	88.4	66.9	54.3	44.2	38.3	30.2	24.5	13.4
1.65V/cell	428.6	339.7	255.8	185.2	147.3	90.8	69.7	56.2	45.4	39.1	30.7	25.0	13.5
1.60V/cell	458.4	361.9	270.1	193.0	152.5	93.9	71.9	58.0	46.9	40.0	31.0	25.3	13.6

Constant Power Discharge (Watt/cell) at 25 °C

F.V/Time	15min	20min	30min	45min	1h	2h	3h	4h	5h	6h	8h	10h	20h
1.85V/cell	533.8	451.0	362.5	276.7	227.3	145.8	115.7	94.8	76.6	66.9	54.5	46.7	25.5
1.80V/cell	636.3	525.3	421.2	319.3	253.3	158.0	123.8	100.7	81.9	71.5	57.7	49.4	25.7
1.75V/cell	686.5	559.7	433.6	328.2	263.8	163.3	125.6	102.6	83.8	73.2	58.5	49.8	25.9
1.70V/cell	722.7	583.8	448.8	340.0	271.2	169.4	128.9	105.1	85.7	74.6	59.3	50.3	26.4
1.65V/cell	762.6	615.6	469.6	345.4	278.3	173.2	133.7	108.3	87.8	76.0	60.1	51.2	26.7
1.60V/cell	802.1	648.6	492.3	358.0	286.7	178.1	137.2	111.3	90.4	77.4	60.5	51.7	26.8

All mentioned values are average values (Tolerance ± 2 %)