

**EFF2**

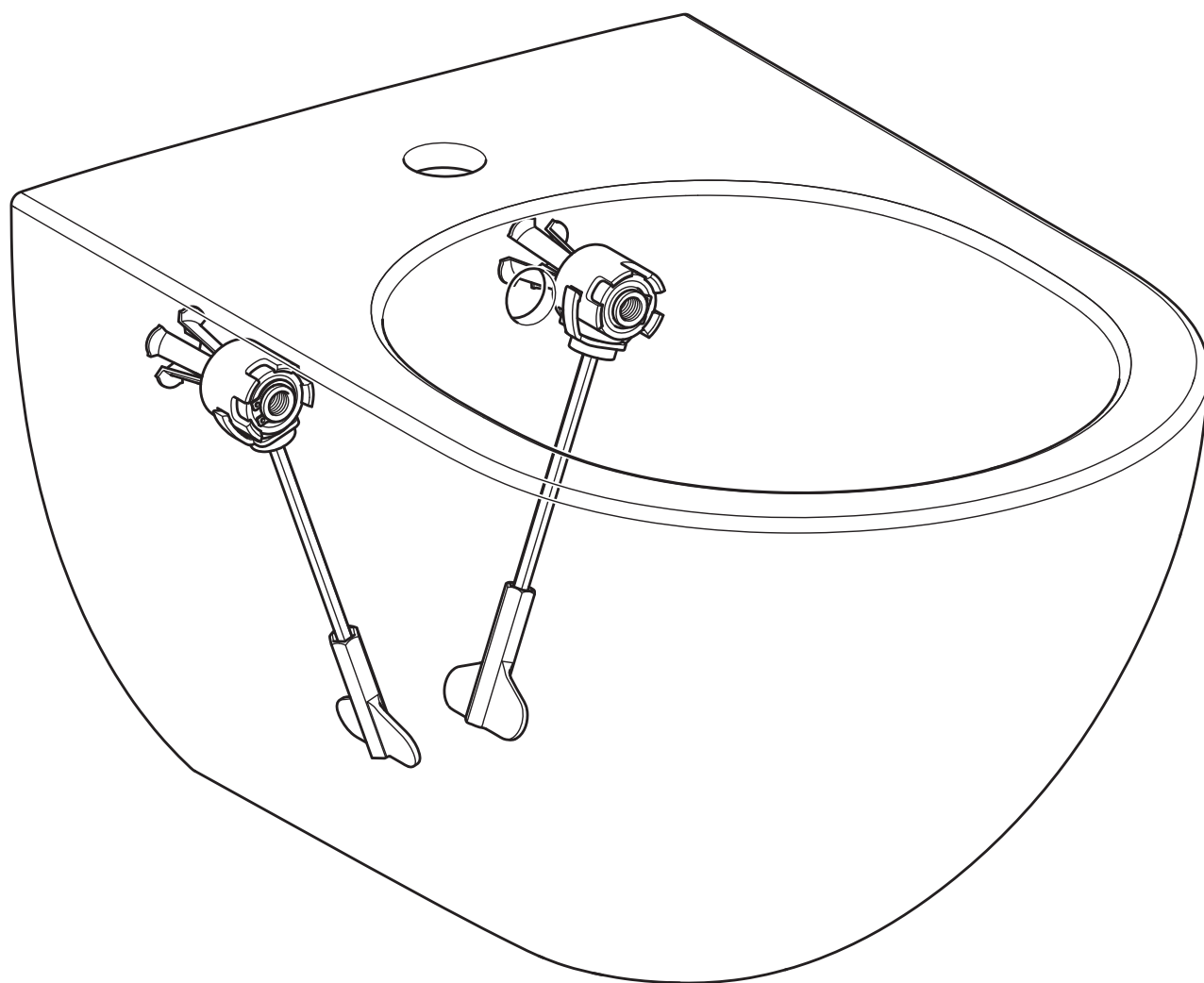

# INSTALLATION MANUAL

MONTAGEANLEITUNG

INSTRUCTIONS DE MONTAGE

ISTRUZIONI PER IL MONTAGGIO

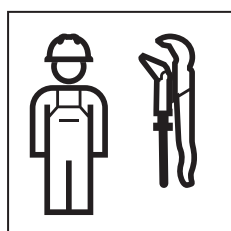



1

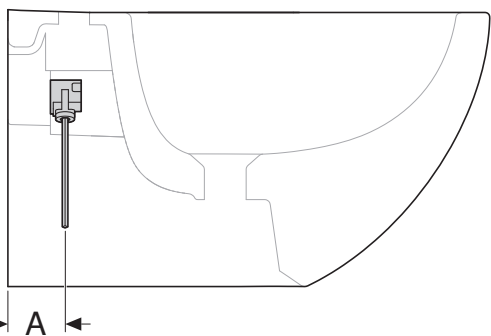
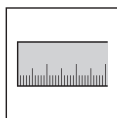

2

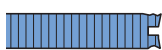
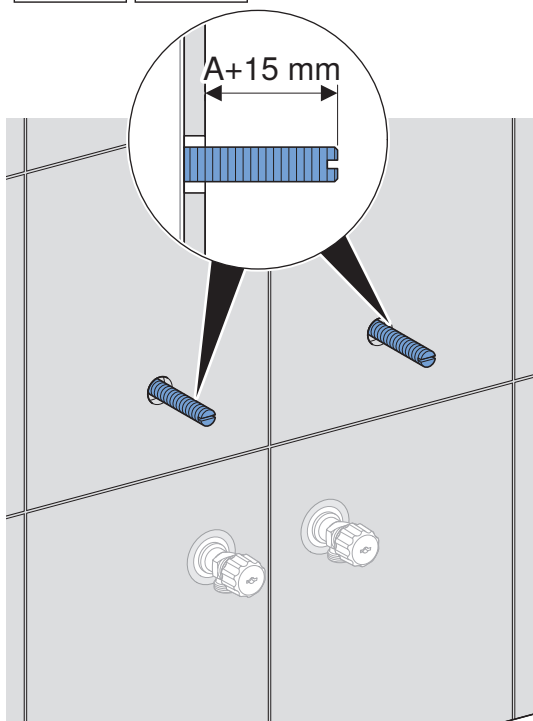
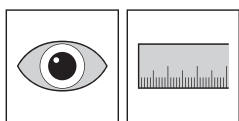

3

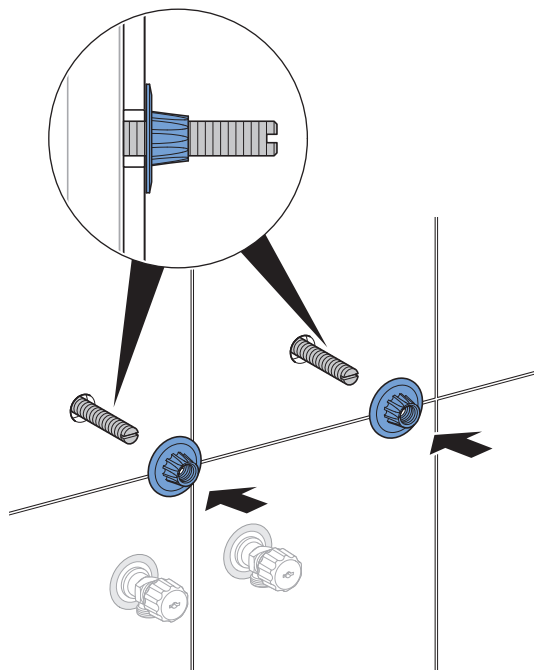

4

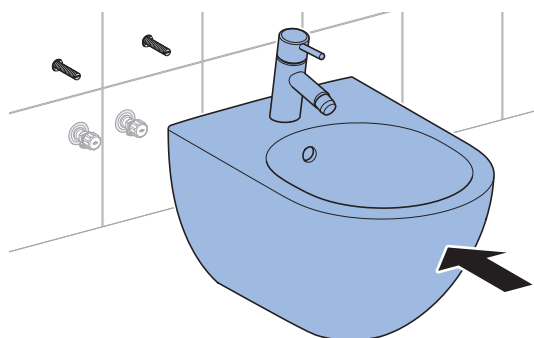

5

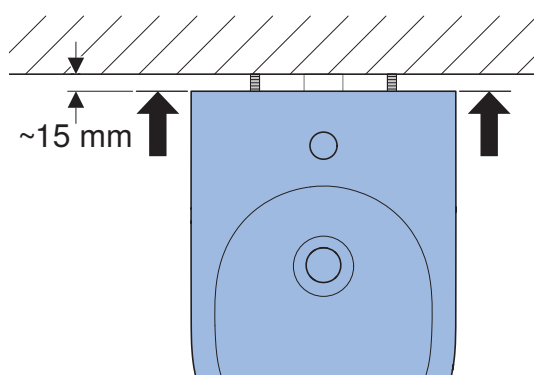
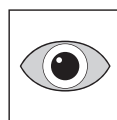

6



---

**Geberit International AG**  
Schachenstrasse 77, CH-8645 Jona  
documentation@geberit.com  
www.geberit.com

