



INSTALLATION MANUAL

MONTAGEANLEITUNG
INSTRUCTIONS DE MONTAGE
ISTRUZIONI PER IL MONTAGGIO



968.731.00.0(02)

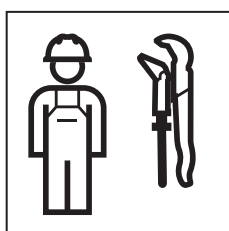



1

1

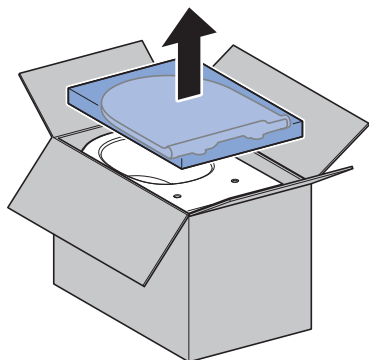

2

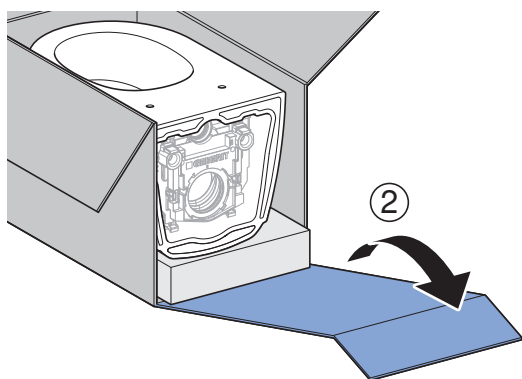
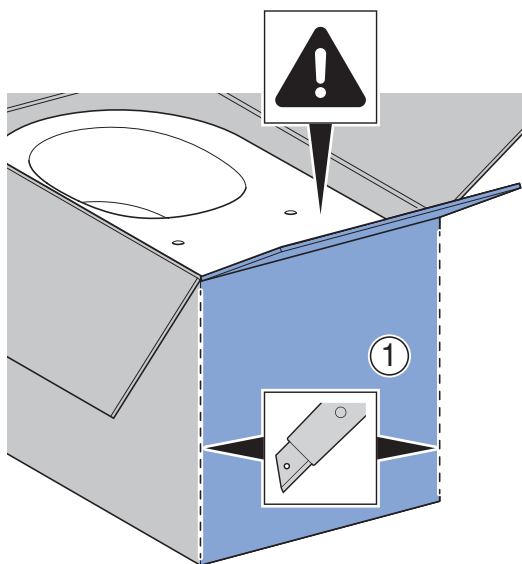

3

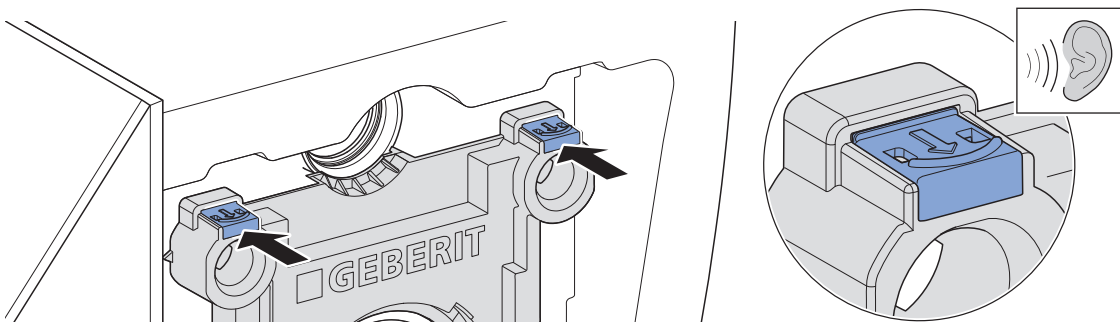
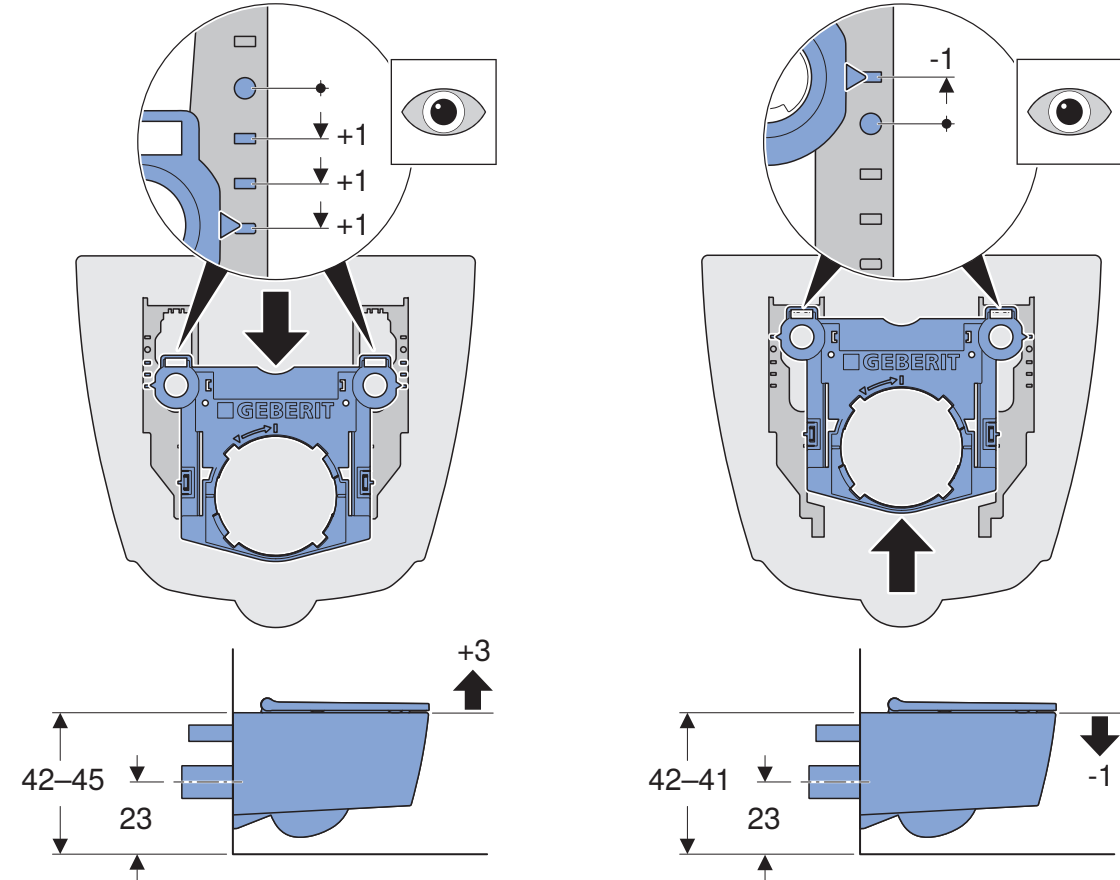
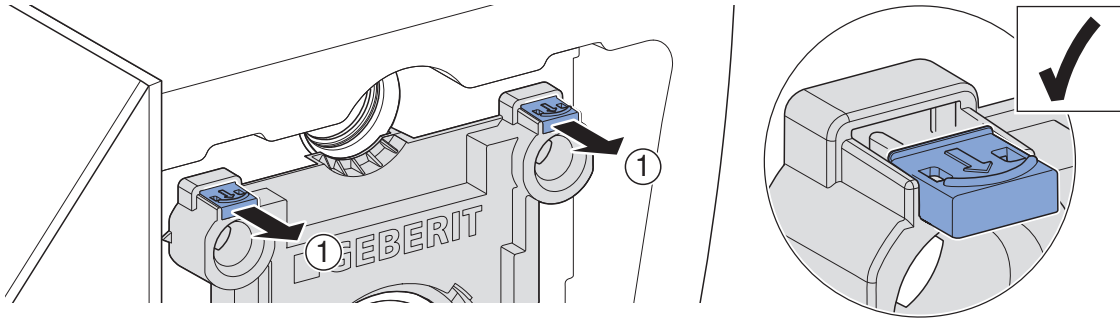

4

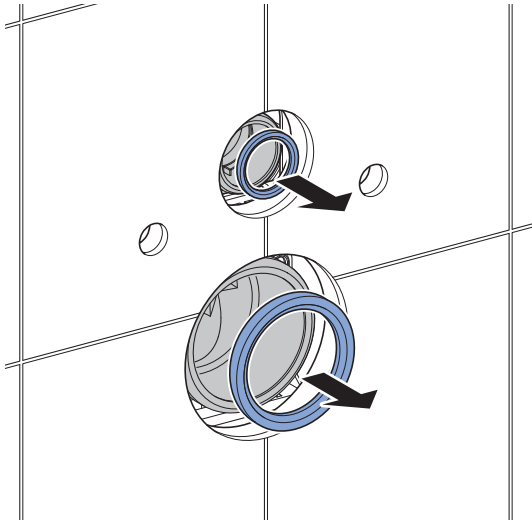

5

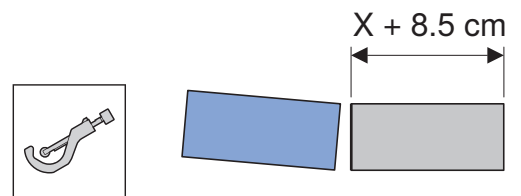
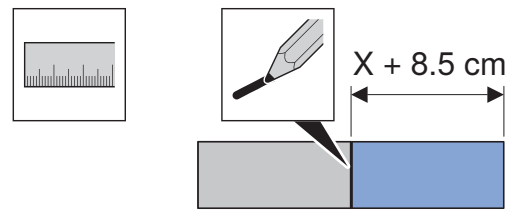
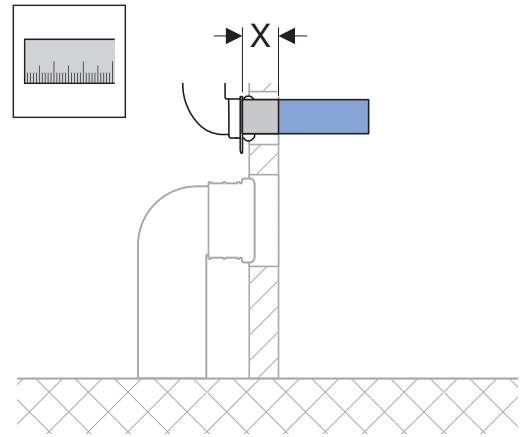

6

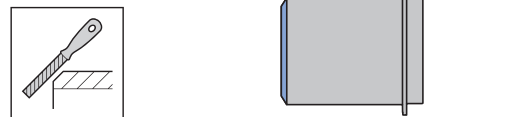
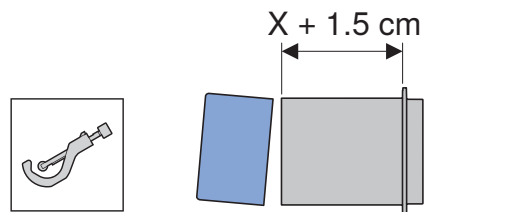
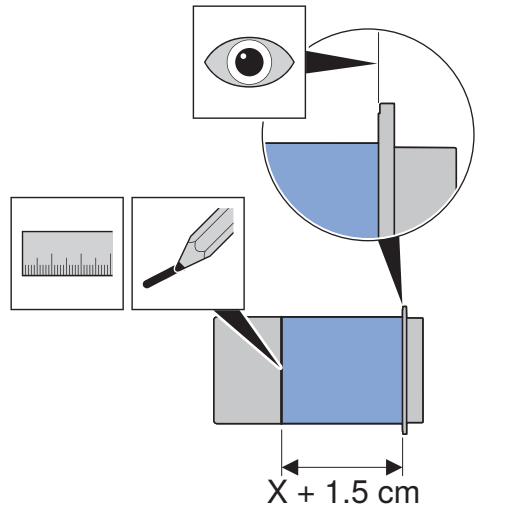
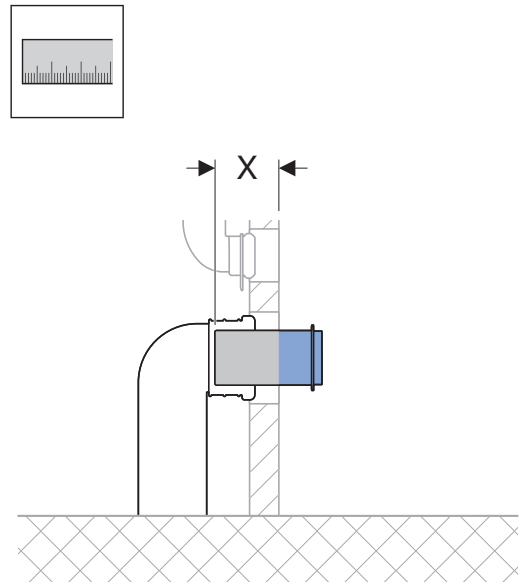

7

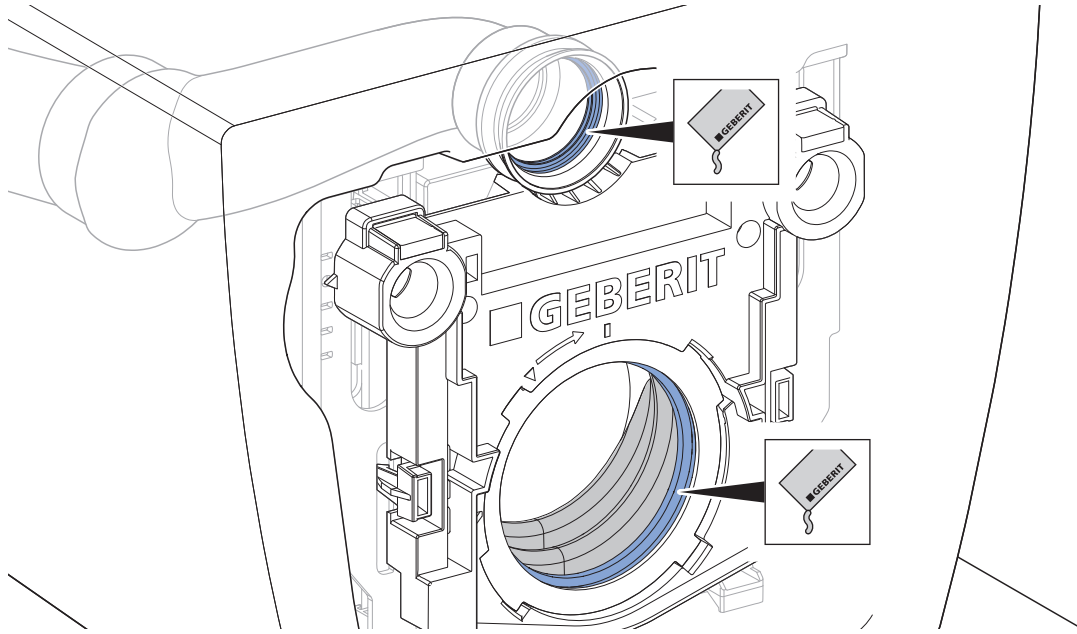

8

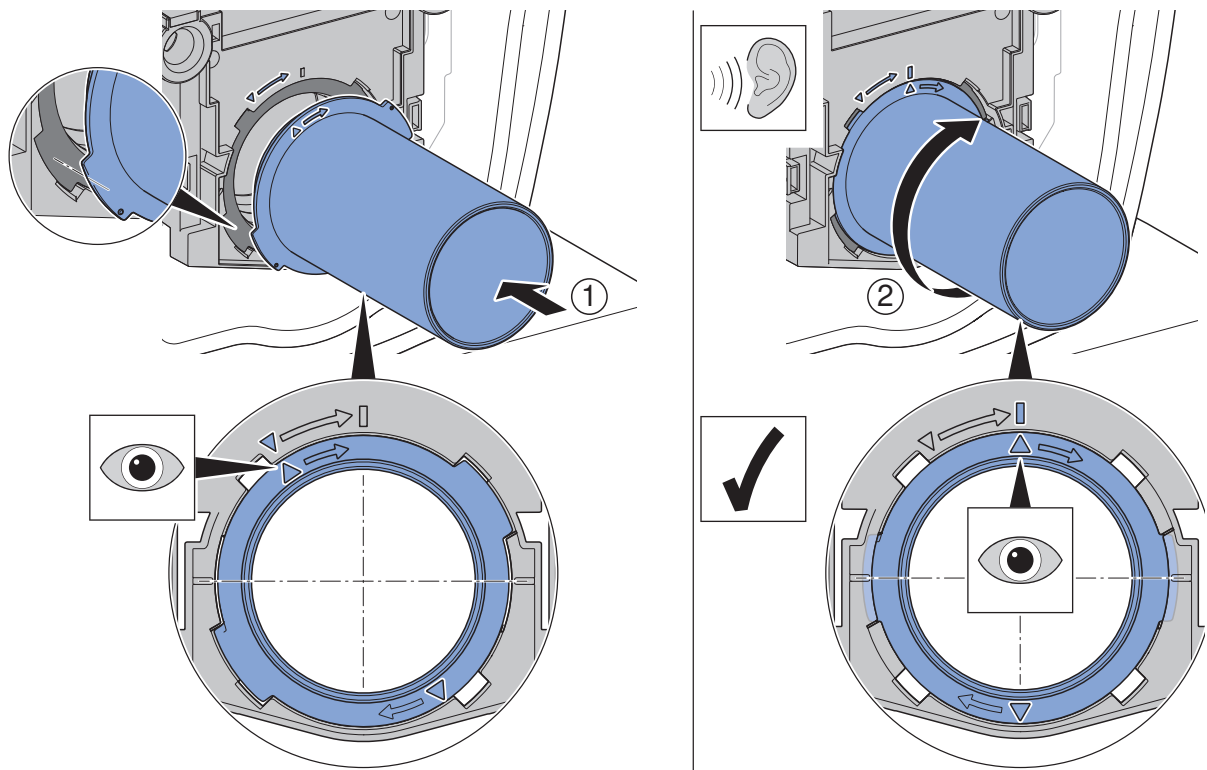

2

1

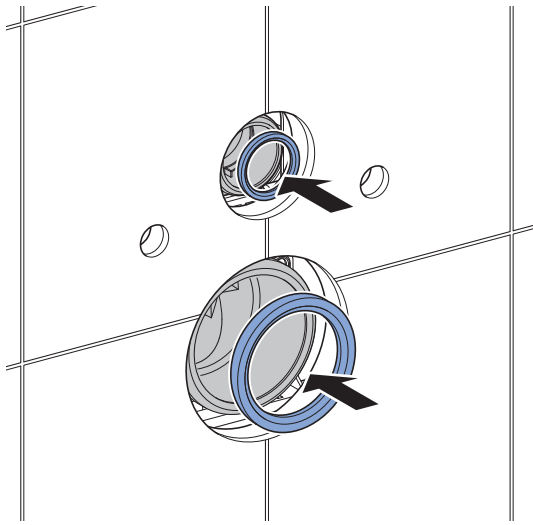

2

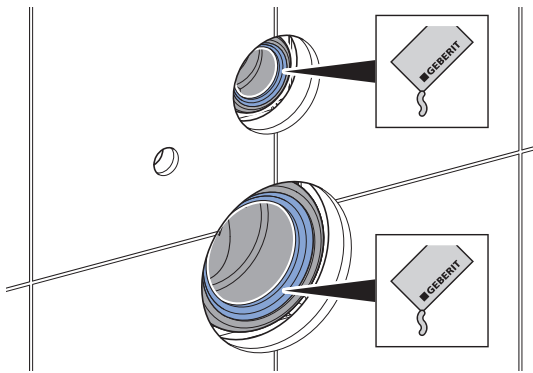

3

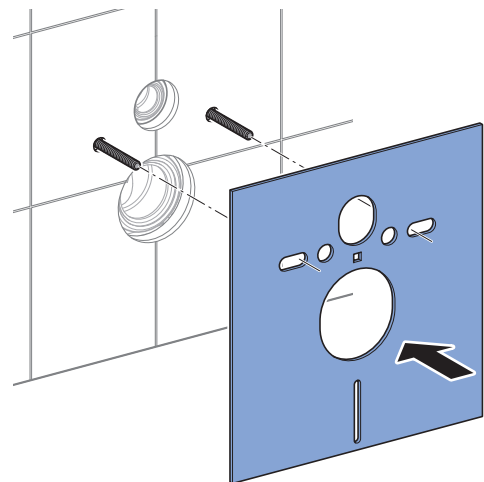

4

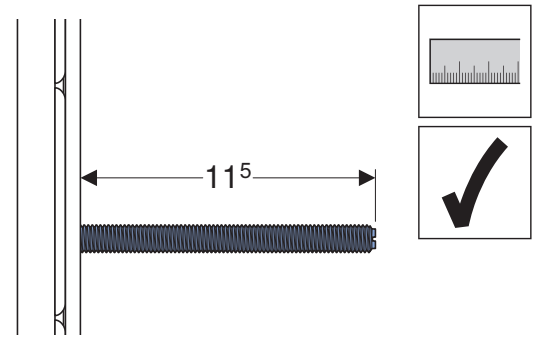
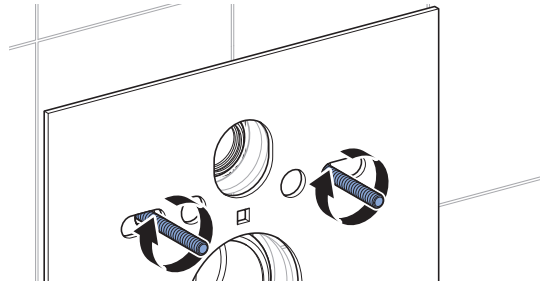

5

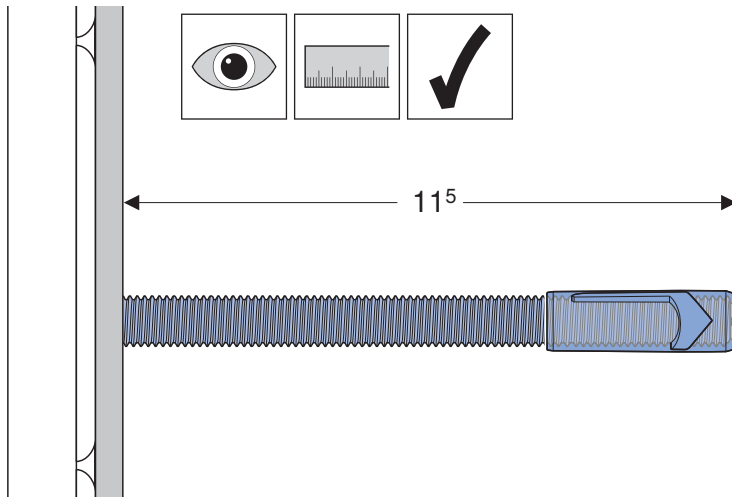
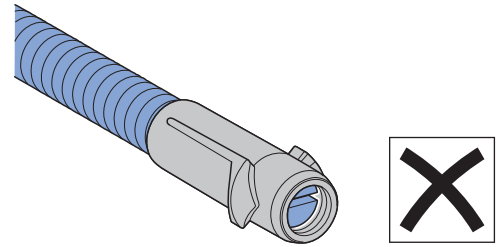
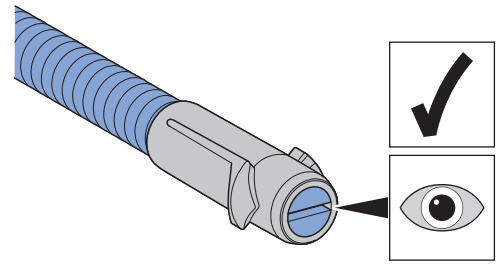
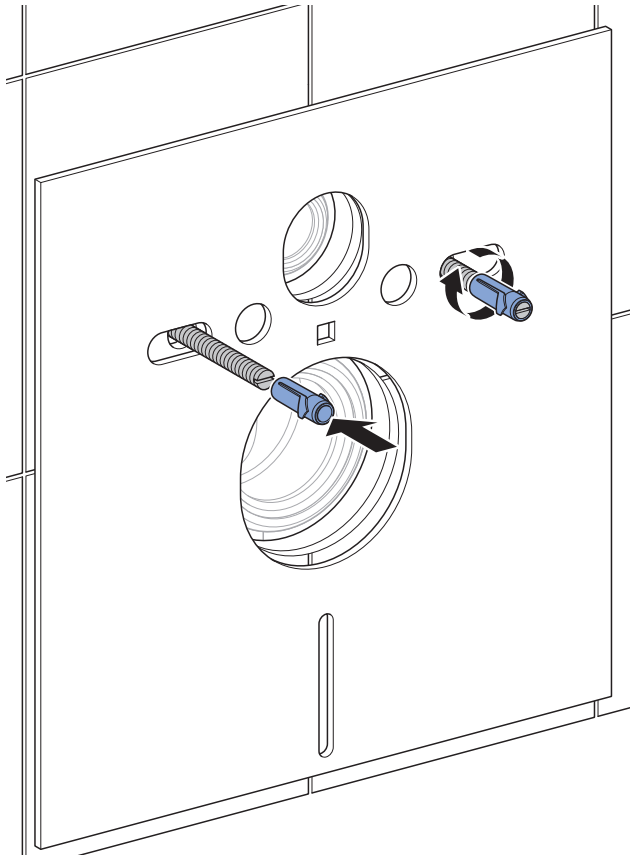

6

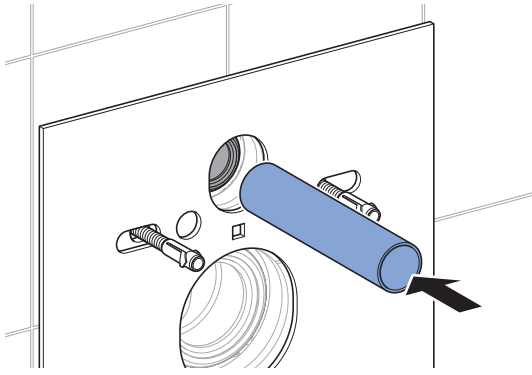

3

✓

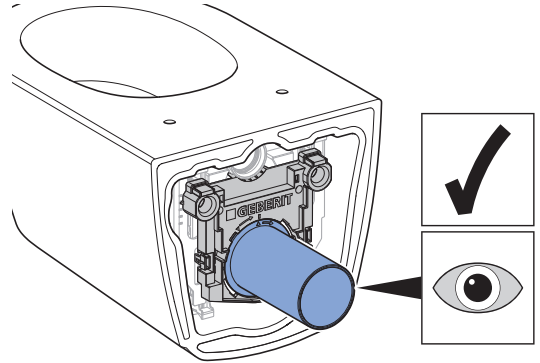

1

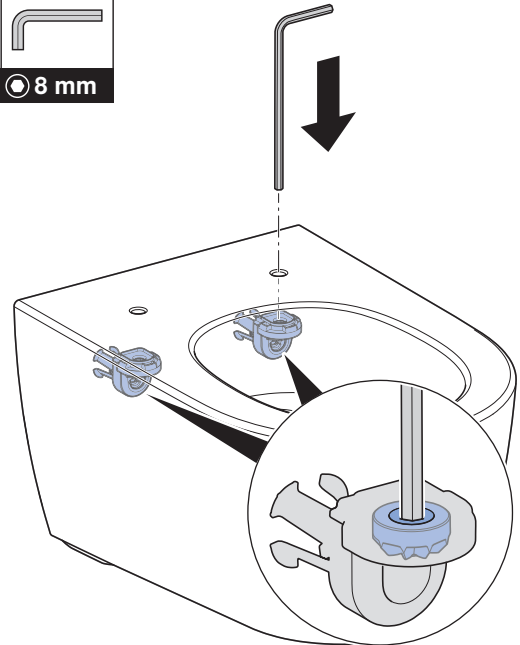
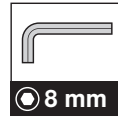

2

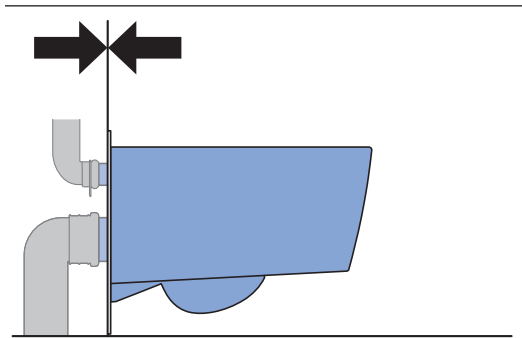
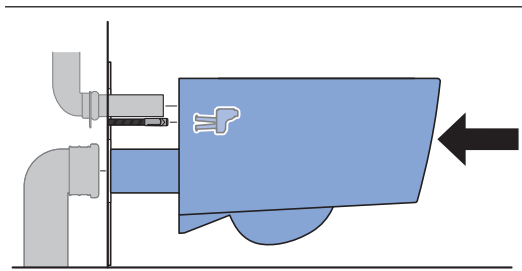
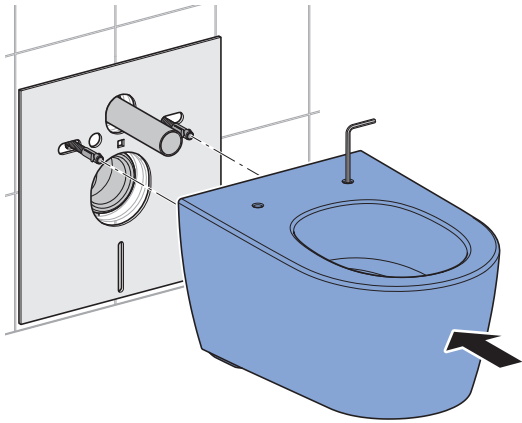

3

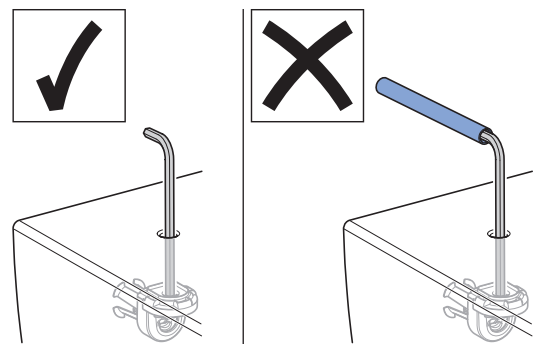
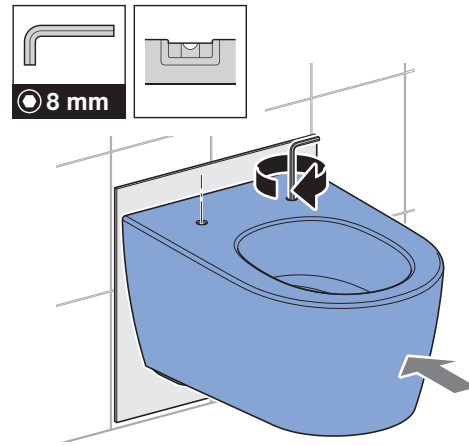

4

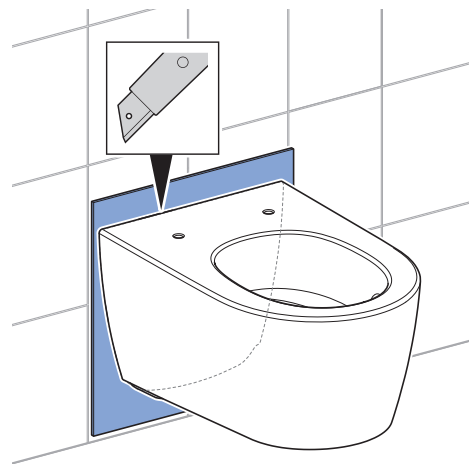

4

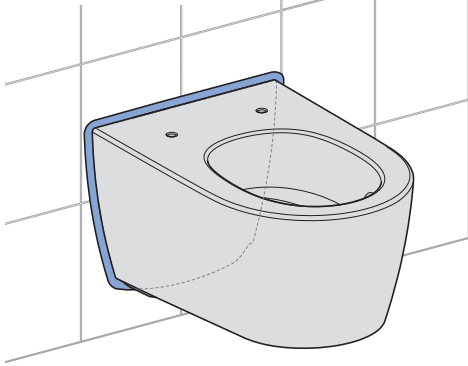
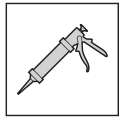

5

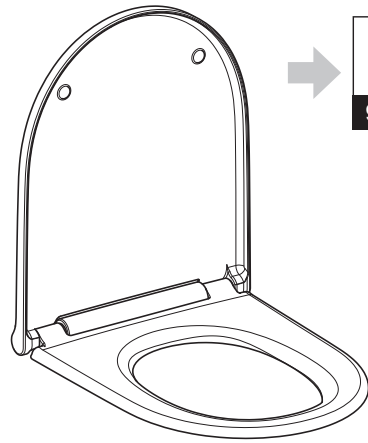

Geberit International AG
Schachenstrasse 77, CH-8645 Jona
documentation@geberit.com
www.geberit.com

