

EAN: 6414150082528

www.oras.com/en/products/oras/product/3017FT



Touchless washbasin faucet with a temperature adjustment handle. The faucet is equipped with litter filters, non-return valves and Autofocus sensor which enables installation without adjustments. Bluetooth connection enables easy monitoring and adjustments of the faucet. Flow rate 6 l/min. Electrical connection with a plug transformer 230/9 V. Alternative: concealed power supply 199275 (12 V). A maximum five of these items can be connected to the power supply at a time.

F = with flexible pipes

- Public & Semi-public
- Touchless, External transformer, Bluetooth®
- Deck mounted
- Chrome
- Temperature control handle
- Non-return valve(s), Litter filter(s)
- Autofocus sensor
- 3S-installation system for safe and simple mounting

Technical data

Flow properties

Flow-rate at 300 kPa (with flow controller)	0.1 l/s
Pressure loss with flow (0.1 l/s)	200 kPa

Technical properties

Hot water supply	max. +70°C
Working pressure	100 - 1000 kPa
Connection size	G3/8
Projection	164 mm
Material	brass

Software settings

Afterflow period	3 s (1-20 s)
Automatic flush	off (off/1-120 h)
Automatic flush period	30 s (1-1800 s)
Max. flow period	2 min (1 s-30 min)

Electronic properties

Electrical Connection	230 / 9 V
Bluetooth version	4.x

Regulations

EMC Directive	CE 2014/30/EU
EN standard	EN 15091
Noise class	I (ISO 3822) Oras lab.
Protection class	IP 55 / transformer IP 40

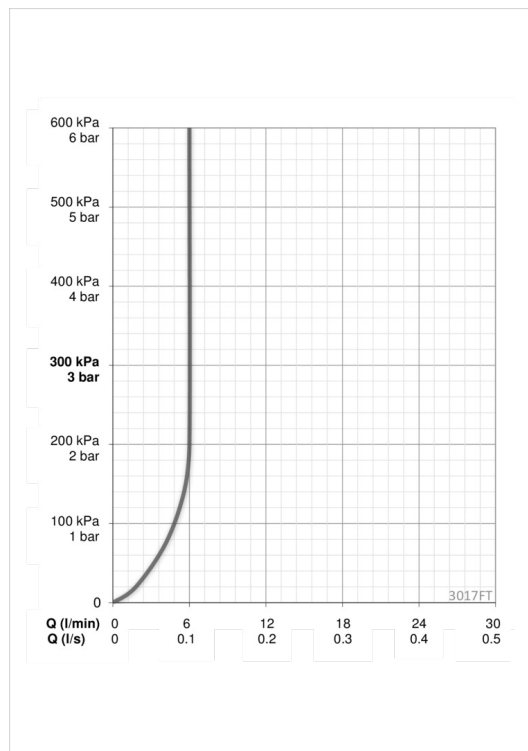

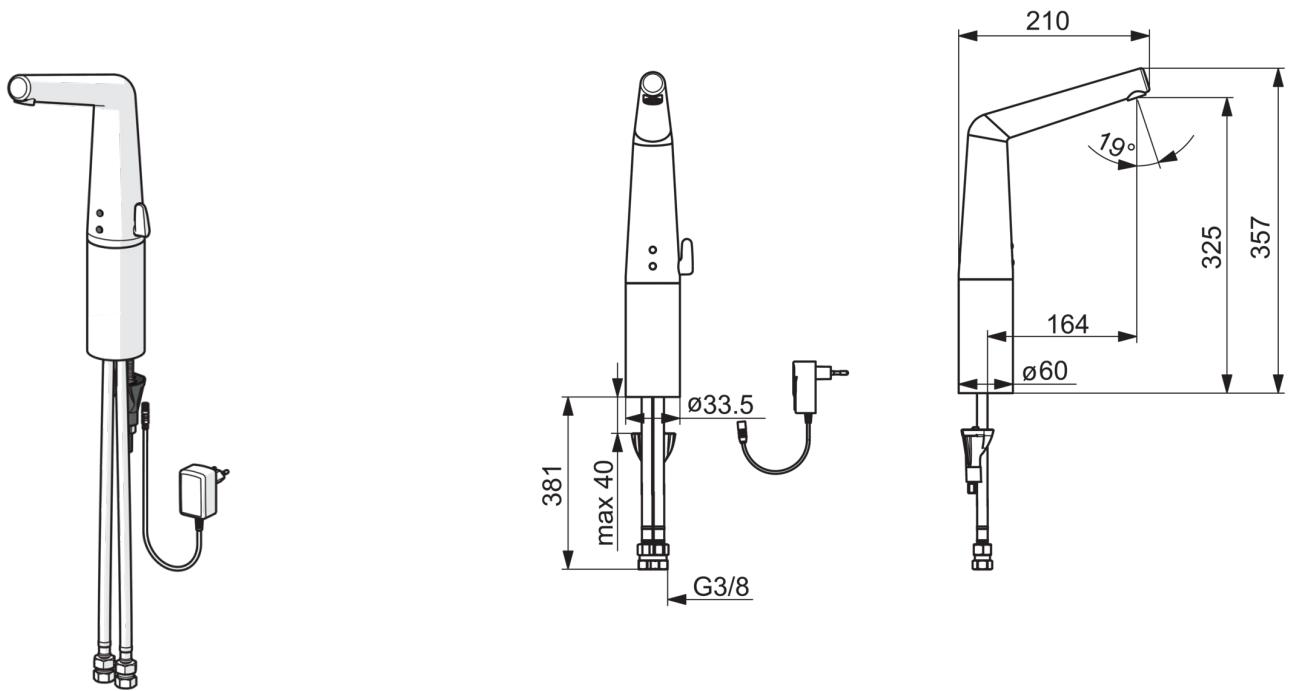

Spare parts

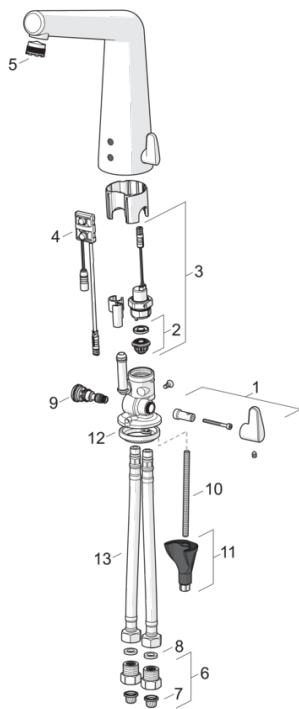

SP3017FT

	Code
01	1002424V
02	199205V
03	199206V
04	1001424V
05	601901V
06	198473/2
07	199257/2
08	600705/10
09	199201V
10	1002624V
11	602610V
12	1002371V
13	602328/2