

# ATR243



**REGOLATORE**  
**Manuale Installatore**

**CONTROLLER**  
**User Manual**



## Summary

1	Introduction .....	3
2	Model Identification .....	3
3	Technical Data .....	4
3.1	General Features .....	4
3.2	Hardware Features .....	4
3.3	Software Features .....	5
4	Dimensions and Installation .....	5
4.1	Panel Assembly .....	6
4.2	Electronics Removal .....	6
5	Electrical wirings .....	7
5.1	Wiring diagram .....	7
6	Display and Key Functions .....	13
6.1	Numeric Indicators (Display) .....	13
6.2	Meaning of Status Lights (Led) .....	13
6.3	Keys .....	14
7	Controller Functions .....	14
7.1	Modifying Main Setpoint and Alarm Setpoint Values .....	14
7.2	Auto-Tune .....	15
7.3	Manual Tuning .....	15
7.4	Automatic Tuning .....	15
7.5	Soft Start .....	16
7.6	Automatic/Manual Regulation for % Output Control .....	16
7.7	Pre-Programmed Cycle .....	17
7.8	Memory Card .....	18
8	LATCH ON Functions .....	19
8.1	Loop Break Alarm On Amperometric Transformer .....	21
8.2	Digital Input Functions .....	22
8.3	Dual Action Heating-Cooling .....	23
9	Serial Communication .....	25
10	Configuration .....	30
10.1	Modify Configuration Parameter .....	30
11	Table of Configuration Parameters .....	31
12	Alarm Intervention Modes .....	44
13	Table of Anomaly Signals .....	49
14	Summary of Configuration parameters .....	50

## 1 Introduction

Thank you for choosing a Pixsys controller.

With the ATR243 model Pixsys makes available in a single device all the resources relevant to sensor input and actuators command, in addition to the extended power range 24...230 Vac/Vdc. With 18 sensors to select and outputs configurable as relay, SSR command, 4...20 mA and 0...10Volt, the user or retailer can reduce warehouse stock by rationalising investment and device availability. The series is completed with models equipped with serial communication RS485 Modbus RTU and with a loading control function via the amperometric transformer. The configuration is further simplified by the Memory cards which are equipped with internal battery and therefore don't require cabling to power the controller.

## 2 Model Identification

The range of ATR243 controllers comes in three versions. Refer to the table below to easily select your preferred model.

Models available, with power 24...230 Vac/Vdc +/-15% 50/60Hz – 3VA

<b>ATR243-20-ABC</b>	2 relays 5A or 1 relay + 1 Ssr/V/mA
<b>ATR243-21-ABC-T</b>	2 relays 5A + 1 Ssr/V/mA + Rs485 +amperometric transformer*
<b>ATR243-31-ABC</b>	3 relays 5A + 1 Ssr/V/mA + amperometric transformer*

\* Models with amperometric transformer input for Loop break alarm function.

### 3 Technical Data

#### 3.1 General Features

<i>Displays</i>	4 0.40 inch displays + 4 0.30 displays
<i>Operating temperature</i>	0-45°C, humidity 35..95uR%
<i>Sealing</i>	IP65 front panel (with gasket) IP20 casing and terminals
<i>Material</i>	PC ABS UL94VO self-extinguishing
<i>Weight</i>	165 g (-20ABC) / 185 g (-21/31ABC)

#### 3.2 Hardware Features

<i>Analogue input</i>	<b>1: AN1</b> Configurable via software <b>Input</b> Thermocouple type K, S, R, J Automatic compensation of cold junction from 0°C to 50°C. <b>Thermoresistance:</b> PT100, PT500, PT1000, Ni100, PTC1K, NTC10K ( $\beta$ 3435K) <b>Linear:</b> 0-10V, 0-20 or 4-20mA, 0-40mV, amperometric transformer 50mA, 1024 points on version ATR243-21/-31 Potentiometers: 6K, 150K,	Tolerance (25°C) +/-0.2 % $\pm$ 1 digit for thermocouple input, thermo resistance and V/mA. Cold junction accuracy 0.1°C/°C
<i>Relay output</i>	<b>2 relays (Atr243-20...-21...)</b> <b>3 relays (Atr243-31...)</b> Configurable as command and/or alarm output	Contacts 5A-250V~
<i>SSR output</i>	<b>1 linear 0/4...20mA /SSR/0...10Volt</b> >deselecting OUT2 relay on ATR243-20... Configurable as command output or retransmission of setpoint or process.	Configurable: > 4-20mA, > 0...10Volt, > 0-20mA. Resolution 4000 points

### 3.3 Software Features

<i>Regulation algorithms</i>	ON-OFF with hysteresis. P, PI, PID, PD with proportional time
<i>Proportional band</i>	0...9999°C or °F
<i>Integral time</i>	0,0...999,9 sec (0 excluded)
<i>Derivative time</i>	0,0...999,9 sec (0 excluded)
<i>Controller functions</i>	Manual or automatic Tuning, configurable alarms, protection of command and alarm setpoints, activation of functions via digital input, preset cycle with Start/Stop.

## 4 Dimensions and Installation

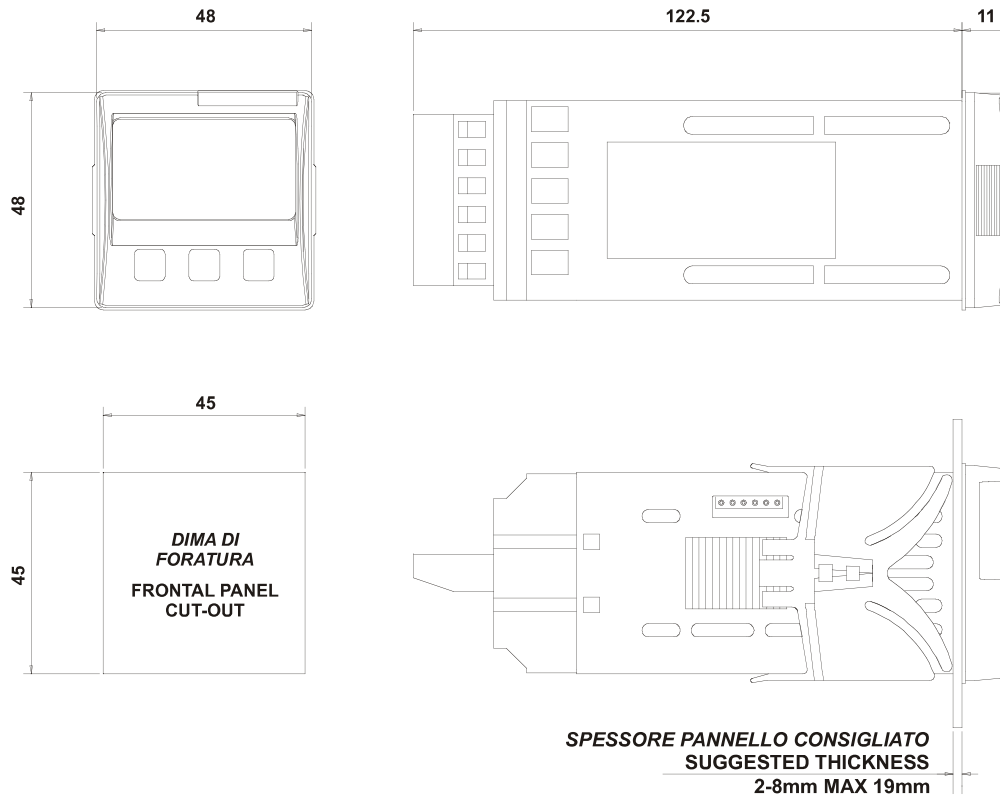

#### 4.1 Panel Assembly

Method of panel assembly and fixing of anchorage hooks.

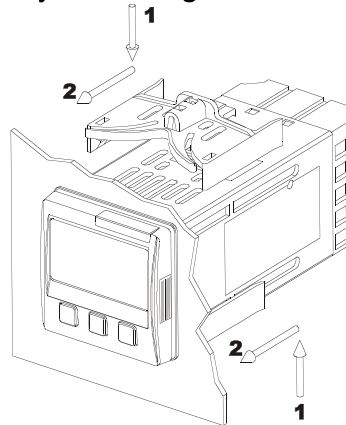

To dismantle, use a screwdriver and slightly force the fixing hooks to remove them from the fixing guide.

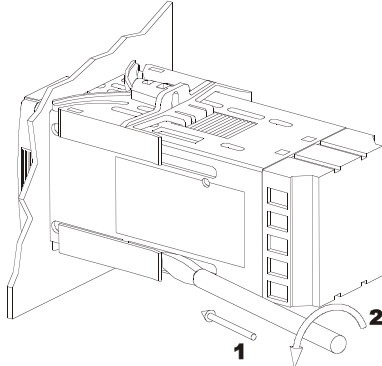

#### 4.2 Electronics Removal

To remove the electronics, grip the front part using the two specific side ridges.

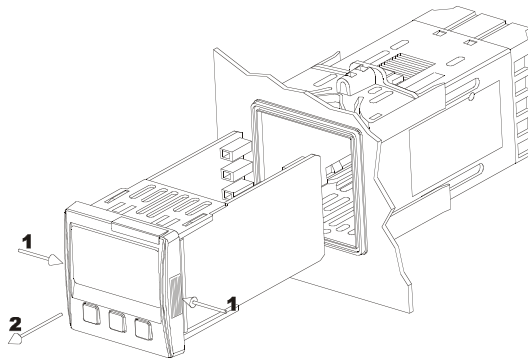

## 5 Electrical wirings



Although this controller was designed to resist noises in industrial environments, please notice following safety guidelines:

- Separate the feeder line from the power lines.
- Avoid placing near units with remote control switches, electromagnetic contactors, high powered motors and in all instances use specific filters.
- Avoid placing near power units, particularly if phase controlled.

### 5.1 Wiring diagram

The connections are reported below for the three models available.

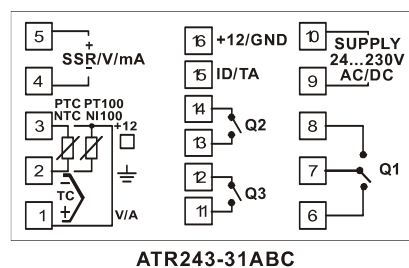
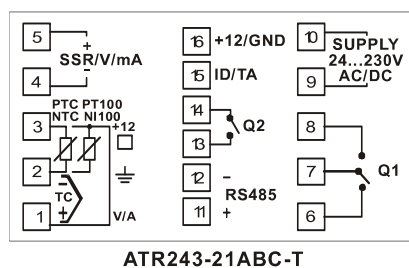
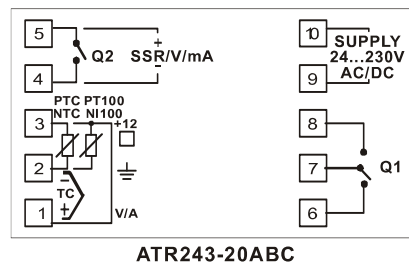
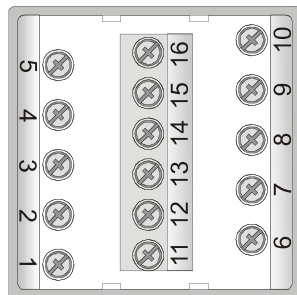

## Power

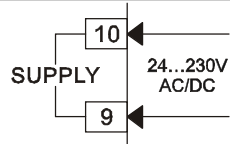

Switching power supply with extended range  
24...230 Vac/dc  $\pm 15\%$  50/60Hz - 3VA.

## AN1 Analogue Input

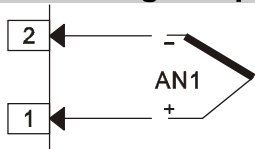

### For thermocouples K, S, R, J.

- Comply with polarity
- For possible extensions, use a compensated wire and terminals suitable for the thermocouples used (compensated)

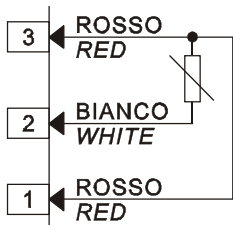

### For thermoresistances PT100, NI100

- For the three-wire connection use wires with the same section
- For the two-wire connection short-circuit terminals 1 and 3
- Select internal jumper **JP3** as in the figure

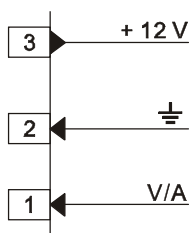
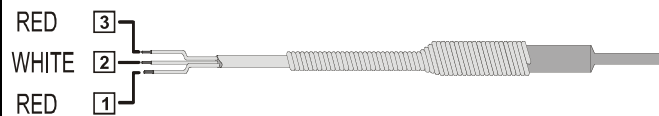
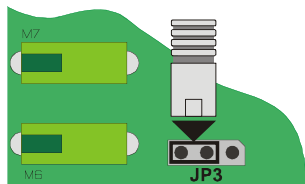

### For linear signals V/mA

- Comply with polarity
- Select internal jumper **JP3** as in the figure

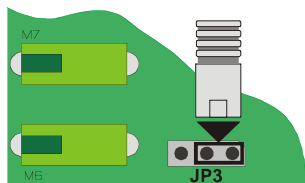

**!** If jumpers are not properly selected, 12Vdc are not available on terminal 3 to power the sensor.



## Examples of Connection for linear input

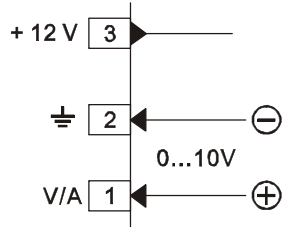

For signals 0...10V  
Comply with polarity

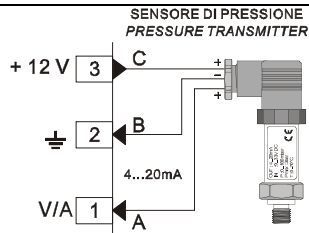

For signals 0/4...20mA with **three-wire sensor**  
Comply with polarity  
A=Sensor output  
B=Sensor ground  
C=Sensor power

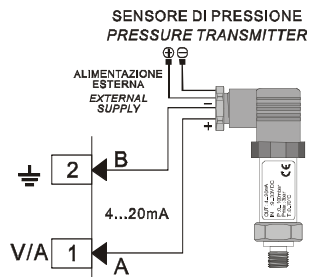

For signals 0/4...20mA with **external power of sensor**  
Comply with polarity  
A=Sensor output  
B=Sensor ground

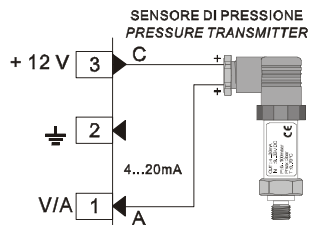

For signals 0/4...20mA with **two-wire sensor**  
Comply with polarity  
A=Sensor output  
C=Sensor power supply

## Serial input

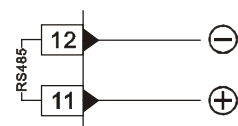

RS485 Modbus RTU communication

### Relay Q1 Output

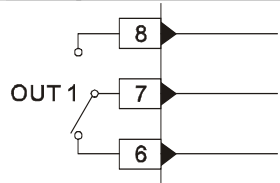

Capacity 5A/250V~ for resistive loads

### Relay Q2 Output

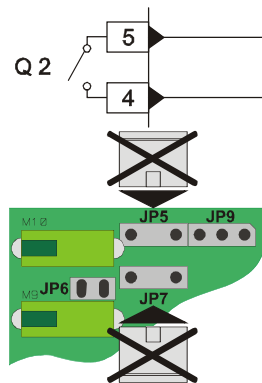

Capacity 5A/250V~ for resistive loads

For Q2 selected as a relay output, remove jumpers JP5 and JP7 as indicated in the figure (Manufacturer configuration).

**! Connecting a load without removing the jumpers will permanently damage the controller**

**For models ATR243-21ABC-T and ATR243-31ABC output Q2 is on terminals 14 and 13.**

### Q2 output for SSR

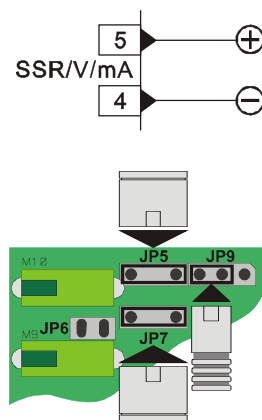

SSR command output 12V/30mA

**! Insert JP5 and JP7 and select JP9 as in the figure to use the SSR output.**

### Q2 Output in mA or in Volt

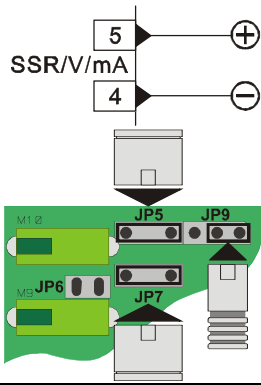

Linear output in **mA** configurable using parameters as command (Parameter `COUT`) or retransmission of process-setpoint (Parameter `RETR.`)

**⚠ Insert JP5 and JP7 and select JP9 as in figure to use the output in mA.**

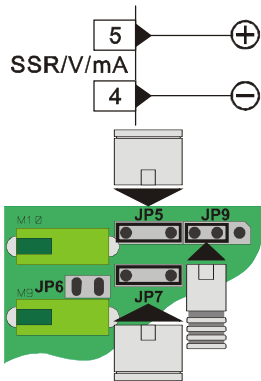

Linear output in **Volt** configurable using parameters as command (Parameter `COUT`) or retransmission of process-setpoint (Parameter `RETR.`)

**⚠ Insert JP5 and JP7 and select JP9 as in figure to use the linear output in Volt.**

### Q3 Relay Output on ATR243-31ABC

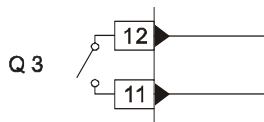

Capacity 5A/250V~ resistive loads

### Amperometric Transformer Input on ATR243-21ABC-T and ATR243-31ABC

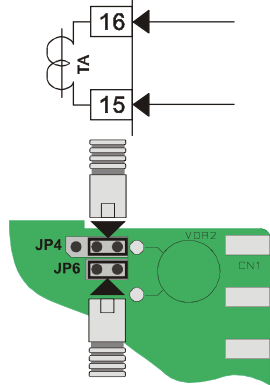

- Input 50mA for amperometric transformer
- Sampling time 80ms
- Configurable by parameters

**⚠ Insert JP4 and JP6 as in figure to select the amperometric transformer input.**

### Digital Input on ATR243-20ABC

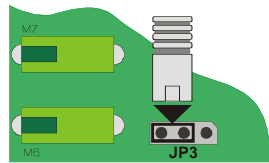

Digital input using parameter `DCI. 1`.  
The use of digital input in this version is possible only with TC sensors, 0...10V, 0/4...20mA and 0...40mV

**⚠ Select internal jumper JP3 as in figure.**

### Digital Input on ATR243-21ABC-T and ATR243-31ABC

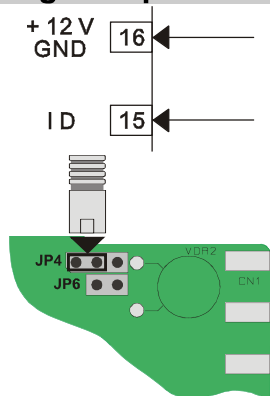

Digital input using parameter `DCI. 1`

**⚠ Insert JP4 as in figure to select the digital input.**

## 6 Display and Key Functions

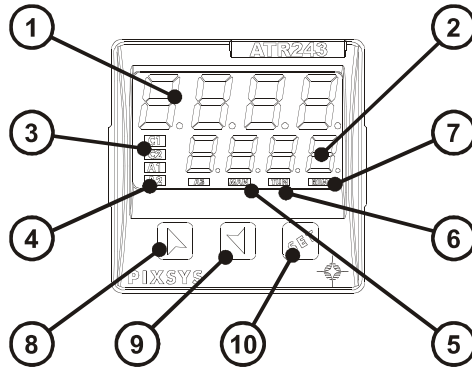







### 6.1 Numeric Indicators (Display)

1		Normally displays the process. During the configuration phase, it displays the parameter being inserted.
2		Normally displays the setpoint. During the configuration phase, it displays the parameter value being inserted.

### 6.2 Meaning of Status Lights (Led)

3		ON when the output command is on. C1 with relay/SSR/mA/Volt command or C1 (open) and C2 (close) for a motorised valve command.
4		ON when the corresponding alarm is on.
5		ON when the "Manual" function is on.
6		ON when the controller is running an "Autotune" cycle.
7		ON when the controller communicates via serial port.







## 6.3 Keys

8		<ul style="list-style-type: none"> <li>• Allows to increase the main setpoint.</li> <li>• During the configuration phase, allows to slide through parameters. Together with the  key it modifies them.</li> <li>• Pressed after the  key it allows to increase the alarm setpoint.</li> </ul>
9		<ul style="list-style-type: none"> <li>• Allows to decrease the main setpoint.</li> <li>• During the configuration phase, allows to slide through parameters. Together with the  key it modifies them.</li> <li>• Pressed after the  key it allows to decrease the alarm setpoint.</li> </ul>
10		<ul style="list-style-type: none"> <li>• Allows to display the alarm setpoint and runs the autotuning function.</li> <li>• Allows to vary the configuration parameters.</li> </ul>

## 7 Controller Functions

### 7.1 Modifying Main Setpoint and Alarm Setpoint Values

The setpoint value can be changed from the keyboard as follows:

	Press	Effect	Operation
1	 or 	Value on display 2 changes	Increases or decreases the main setpoint
2		Visualize alarm setpoint on display 1	
3	  	Value on display 2 changes	Increases or decreases the alarm set point value



## 7.2 Auto-Tune

The Tuning procedure calculates the controller parameters and can be manual or automatic according to selection on parameter 57 (TUNE).

## 7.3 Manual Tuning

The manual procedure allows the user greater flexibility to decide when to update PID algorithm work parameters. The procedure can be activated in two ways.

- **By running Tuning from keyboard:**

Press the  key until display 1 shows the writing TUNE with display 2 showing OFF, press , display 2 shows ON. The TUN led switches on and the procedure begins.

- **By running Tuning from digital input:**

Select TUNE on parameter 61 (DIG. I).



On first activation of digital input (commutation on front panel) the TUN led switches on and on second activation switches off.

## 7.4 Automatic Tuning

Automatic tuning activates when the controller is switched on or when the setpoint is modified to a value over 35%.

To avoid an overshoot, the threshold where the controller calculates the new PID parameters is determined by the setpoint value minus the "Set Deviation Tune" ( see Parameter 58 (SDTU) ).

To exit Tuning and leave the PID values unchanged, just press the

 key until display 1 shows the writing TUNE with the display showing ON, press , display 2 shows OFF.

The TUN led switches off and the procedure finishes.

## 7.5 Soft Start

To reach the setpoint the controller can follow a gradient expressed in units (e.g. degree/hour).

Set the increase value in parameter 62 `GrAd` with the desired units/hour; only **on subsequent activation** the controller uses the soft start function.



Automatic/manual tuning cannot be enabled if the Soft start is active.

## 7.6 Automatic/Manual Regulation for % Output Control

This function allows you to select automatic functioning or manual command of the output percentage.

With parameter 60 `Auto`, you can select two methods.

1. **The first selection** `En` allows you to enable the  key with the writing `P.---` on display 1, while display two shows `Auto`.

Press the  key to show `MAN`; it is now possible, during the process display, to change the output percentage using the keys  and . To return to automatic mode, using the same procedure, select `Auto` on display 2: the `MAN` led switches off and functioning returns to automatic mode.

2. **The second selection** `EnSt` enables the same functioning, but with two important variants:
  - If there is a temporary lack of voltage or after switch-off, the manual functioning will be maintained as well as the previously set output percentage value.
  - If the sensor breaks during automatic functioning, the controller moves to manual mode while maintaining the output percentage command unchanged as generated by the PID immediately before breakage.



## 7.7 Pre-Programmed Cycle

The pre-programmed cycle function activates by setting `PrCY` or `PrSS` in parameter 59 `OPNa`.

**First option `PrCY`** : the controller reaches setpoint1 basing on the gradient set in parameter 62 `GrAd`, then it reaches maximum power up to setpoint2. When the process reaches maximum power, this setpoint is maintained for the time set in parameter 63 `PrEt`. On expiry, the command output is disabled and the controller displays `StOp`.

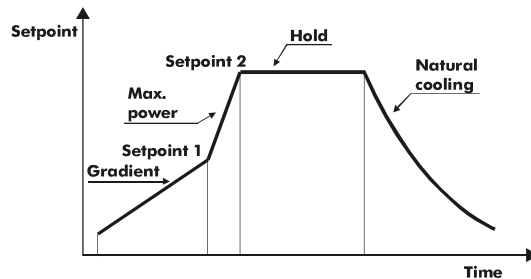

The cycle starts at each activation of the controller, or via digital input if it is enabled for this type of functioning (see parameter 61 `dcE`).

**Second option `PrSS`** : start-up is decided only on activation of the digital input, according to the setting of parameter 61 `dcE`. On start-up, the controller reaches setpoint 1 basing on the gradient set in parameter 62 `GrAd`. When the process reaches this gradient, it is maintained for the time set in parameter 63 `PrEt`. On expiry, the command output is disabled and the controller displays `StOp`.

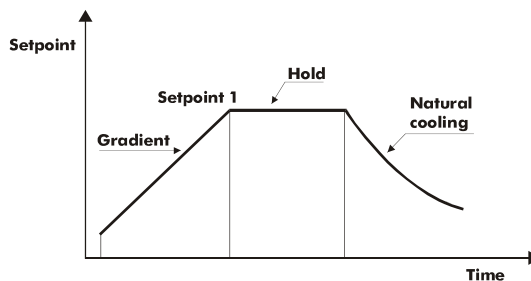

## 7.8 Memory Card



Parameters and setpoint values can be duplicated from one controller to another using the Memory card.

There are two methods:

- With the controller connected to the power supply

Insert the memory card **when the controller is off.**

On activation display 1 shows **MEMO** and display 2 shows **----**  
**(Only if the correct values are saved in the memory card).** By

pressing the  key display 2 shows **LOAD**, then confirm using the  key. The controller loads the new data and starts again.

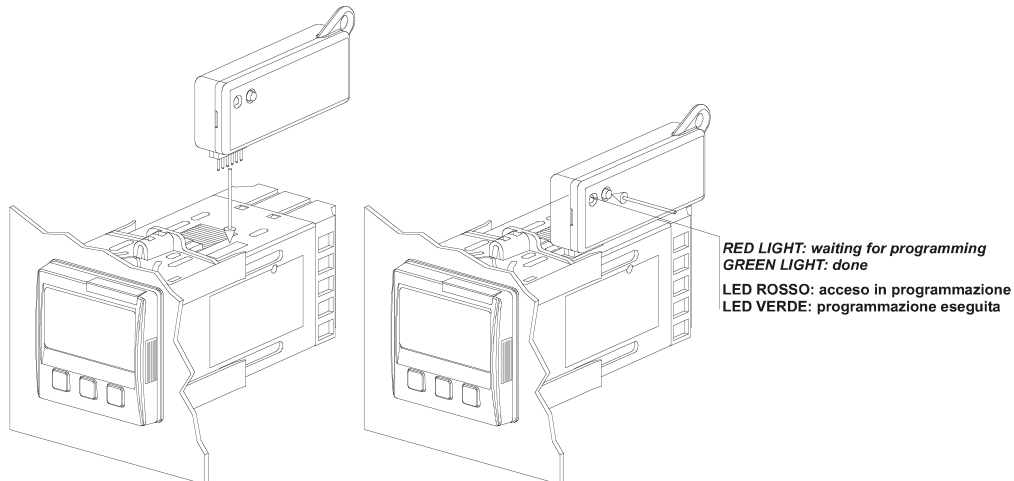

- With the controller not connected to power supply.

The memory card is equipped with an internal battery with an autonomy of about 1000 uses.

Insert the memory card and press the programming buttons.

When writing the parameters, the led turns red and on completing the procedure it changes to green. It is possible to repeat the procedure without any particular attention.

## Updating Memory Card

To *update* the memory card values, follow the procedure described in the first method, setting display 2 to  so as not to load the parameters on controller<sup>2</sup>.

Enter configuration and **change at least one parameter**.

Exit configuration. Changes are saved automatically.

## 8 LATCH ON Functions

For use with input  (potentiometer 6K) and  (potentiometer 150K ) and with linear input (0...10V, 0...40mV, 0/4...20mA), you can associate start value of the scale (parameter 6 ) to the minimum position of the sensor and value of the scale end (parameter 7 ) to the maximum position of the sensor (parameter 8  configured as ).

It is also possible to fix the point in which the controller will display 0 (however keeping the scale range between  and ) using the “virtual zero” option by setting  or  in parameter 8 . If you set  the virtual zero will reset after each activation of the tool; if you set  the virtual zero remains fixed once tuned.









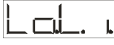

To use the LATCH ON function configure as you wish the parameter <sup>3</sup>.

---

<sup>2</sup> If on activation the controller does not display  it means no data have been saved on the memory card, but it is possible to update values.

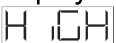
<sup>3</sup> The tuning procedure starts by exiting the configuration after changing the parameter.

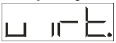
For the calibration procedure refer to the following table:

	Press	Effect	Operation
1		Exit parameters configuration. Display 2 shows the writing  .	Position the sensor on the minimum functioning value (associated with  )
2		Set the value to minimum. The display shows  .	Position the sensor on the maximum functioning position (associated with  )
3		Set the value to maximum. The display shows  .	To exit the standard procedure press  . For “virtual zero” settings position the sensor on the zero point.
4		Set the virtual zero value. The display shows  . N.B.: for selection of  the procedure in point 4 should be followed on each re-activation.	To exit the procedure press  .



## 8.1 Loop Break Alarm On Amperometric Transformer



This function allows to measure load current and to manage an alarm during malfunctioning with power in short circuit or always off. The amperometric transformer connected to terminals 15 and 16 must be 50mA (sampling time 80ms).

- Set scale end value of the amperometric transformer in Amperes on parameter 47
- Set the intervention threshold of the Loop break alarm in Amperes on parameter 48
- Set the intervention delay time of the Loop break alarm on parameter 49
- You can associate the alarm with a relay by setting the parameter ,  or  as

If a remote control switch or SSR remains closed, the controller signals the fault by showing  on display 2 (alternatively with a command setpoint).

If instead the power stage remains open, or the load current is lower than the value set on , the controller shows  on display.

You can display the current absorbed during the closure phase of the power stage.

	Press	Effect	Operation
1		This key enables to scroll on display 2 the output percentage, auto/man selection, setpoint and alarms.	Press  until the writing <input type="text" value="ANEA"/> appears on display 1 and display 2 shows the current in amperes ( <input type="text" value="EA"/> > 0). The value is also maintained when no current circulates on the load.

## 8.2 Digital Input Functions

Digital input is programmable for several functions which are useful to simplify controller operability. Select the desired function on parameter 62 `DIET`.

1. Hold function (enabled by setting `LCnA` or `LCnE`.) allows to lock the reading of sensors when the digital input is active (useful for wide ranging oscillation on less significant values). During the lock phase, display 2 flashes and shows `Loct`.
2. Enables/disables the autotuning function from digital input if the parameter `tunE` is set on `On`.
3. Enable regulation with `rna` or `rnc`.
4. Switch from automatic to manual functioning if `AWA` is set on `En` or `EnSE`.
5. Start of pre-programmed cycle (see paragraph 7.7) with `SESE`.
6. Change setpoint function.  
This function is useful where there are 2 to 4 working thresholds required during system functioning without having to press the arrow keys.

To enable the function use the parameter `OPnA`, by selecting the number of setpoints desired (no. thresholds switch). They can be switched during functioning by pressing the  key.

### **N.B.:**

The digital input functions **are not** available with sensors PT100 and NI100 on model ATR243-20ABC.

### 8.3 Dual Action Heating-Cooling

ATR243 is also suitable also for systems requiring a combined heating-cooling action.

The command output must be configured as Heating PID ( $\text{ACT.E.} = \text{HEAT}$  and with a  $\text{PB}$  greater than 0), and one of the alarms ( $\text{AL. 1}$ ,  $\text{AL. 2}$  or  $\text{AL. 3}$ ) must be configured as  $\text{COOL}$ . The command output must be connected to the actuator responsible for heat, while the alarm will control cooling action.

The parameters to configure for the Heating PID are:

$\text{ACT.E.} = \text{HEAT}$  Command output type (Heating)

$\text{PB}$ : Heating proportional band

$\text{E. i}$ : Integral time of heating and cooling

$\text{E.d}$ : Derivative time of heating and cooling

$\text{E.c.}$ : Heating time cycle

The parameters to configure for the Cooling PID are the following (example: action associated to alarm1):

$\text{AL. 1} = \text{COOL}$  Alarm1 selection (cooling)

$\text{PBn}$ : Proportional band multiplier

$\text{owdb}$ : Overlapping/Dead band

$\text{cat.c.}$ : Cooling time cycle

The parameter  $\text{PBn}$  (that ranges from 1.00 to 5.00) determines the proportional band of cooling basing on the formula:

**Cooling proportional band** =  $\text{PB} * \text{PBn}$

This gives a proportional band for cooling which will be the same as heating band if  $\text{PBn} = 1.00$ , or 5 times greater if  $\text{PBn} = 5.00$ .

The **integral time and derivative time** are the same for both actions.

The parameter  $\text{owdb}$  determines the percentage overlapping between the two actions. For systems in which the heating output and cooling output must never be simultaneously active a dead band ( $\text{owdb} \leq 0$ ) must be configured, and vice versa you can configure an overlapping ( $\text{owdb} > 0$ ).

The following figure shows an example of dual action PID (heating-cooling) with  $E_i = 0$  and  $E_d = 0$ .

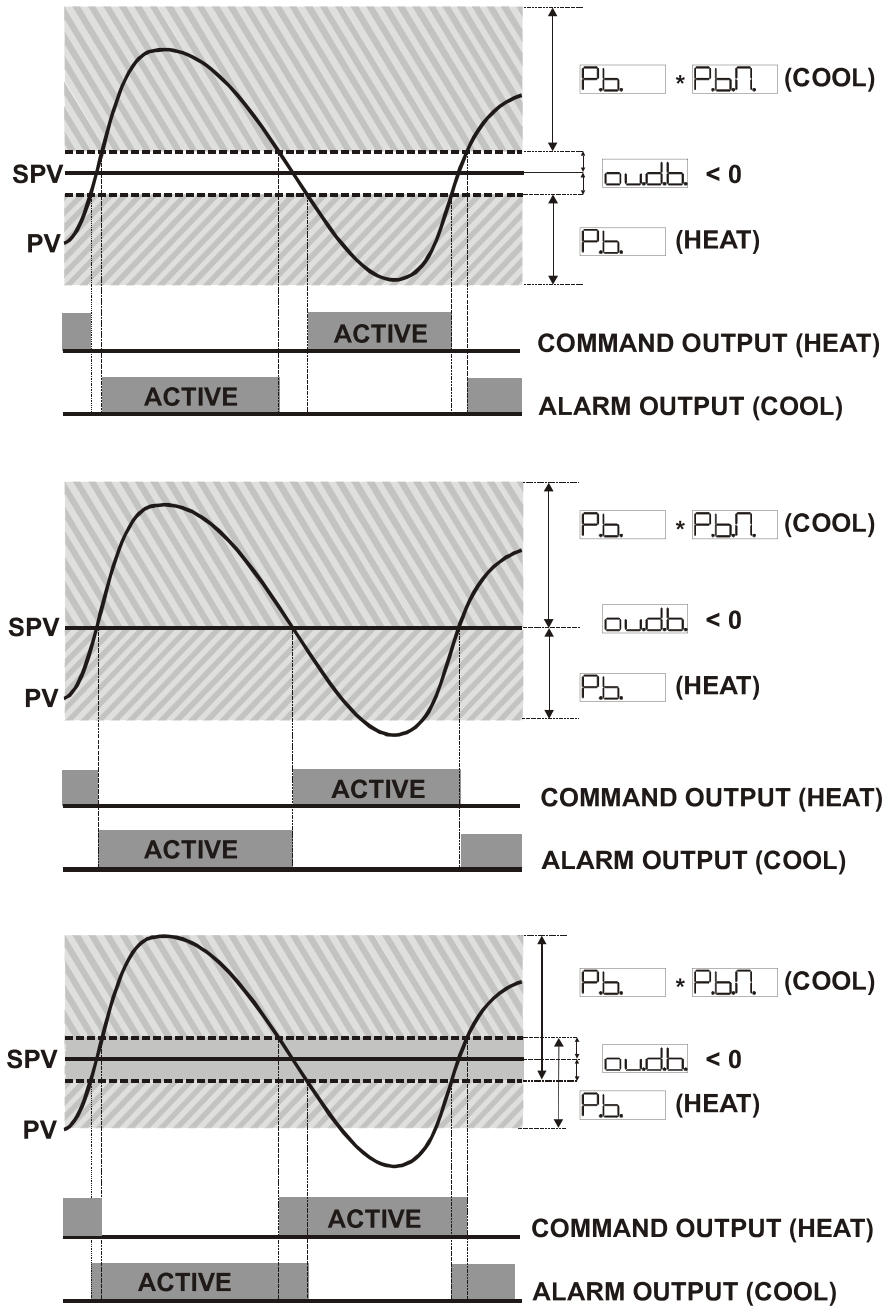



The parameter `cat.c` has the same meaning as the heating time cycle `tc`.

The parameter `coo.f` (cooling fluid) pre-selects the proportional band multiplier `PbN` and the cooling PID time cycle `cat.c` basing on the type of cooling fluid:

<code>coo.f</code>	Cooling fluid type	<code>PbN</code>	<code>cat.c</code>
Air	Air	1.00	10
oil	Oil	1.25	4
H <sub>2</sub> O	Water	2.50	2

Once selected, the parameter `coo.f`, the parameters `PbN`, `oudb` and `cat.c` can however be changed.

## 9 Serial Communication

ATR243-21ABC-T, equipped with RS485, can receive and broadcast data via serial communication using MODBUS RTU protocol. The device can only be configured as a Slave. This function enables the control of multiple controllers connected to a supervisory system (SCADA).

Each controller responds to a master query only if the query contains the same address as that in the parameter `SLAd`. The addresses permitted range from 1 to 254 and there must not be controllers with the same address on the same line.

Address 255 can be used by the master to communicate with all the connected equipment (broadcast mode), while with 0 all the devices receive the command, but no response is expected.

ATR243 can introduce a delay (in milliseconds) in the response to the master request. This delay must be set on parameter 72 `SEDE`.

Each parameter change is saved by the controller in the EEPROM memory (100000 writing cycles), while the setpoints are saved with a delay of ten seconds after the last change.

**NB:** Changes made to words that are different from those reported in the following table can lead to malfunction.

## Modbus RTU protocol features

<i>Baud-rate</i>	Can be selected on parameter 70 <input type="text" value="bdrt."/> <input type="text" value="48 F"/> 4800bit/sec <input type="text" value="96 F"/> 9600bit/sec <input type="text" value="192 F"/> 19200bit/sec <input type="text" value="288 F"/> 28800bit/sec <input type="text" value="384 F"/> 38400bit/sec <input type="text" value="576 F"/> 57600bit/sec
<i>Format</i>	8, N, 1 (8bit, no parity, 1 stop)
<i>Supported functions</i>	WORD READING (max 20 word) (0x03, 0x04) SINGLE WORD WRITING (0x06) MULTIPLE WORDS WRITING (max 20 word) (0x10)

The list below includes all the available addresses, where:



- RO** = Read Only
- R/W** = Read/Write
- WO** = Write Only

Modbus address	Description	Read Write	Reset value
0	Device type	RO	EEPROM
1	Software version	RO	EEPROM
5	Slave Address	R/W	EEPROM
6	Boot version	RO	EEPROM
50	Automatic addressing	WO	-
51	System code comparison	WO	-
1000	Process (with tenths of degree for temperature sensors; digits for linear sensors)	RO	?
1001	Setpoint1	R/W	EEPROM
1002	Setpoint2	R/W	EEPROM
1003	Setpoint3	R/W	EEPROM
1004	Setpoint4	R/W	EEPROM
1005	Alarm1	R/W	EEPROM
1006	Alarm2	R/W	EEPROM
1007	Alarm3	R/W	EEPROM
1008	Setpoint gradient	RO	EEPROM
1009	Relay status (0=off, 1=on) Bit 0 = <b>Q1</b> relay Bit 1 = <b>Q2</b> relay Bit 2 = reserved Bit 3 = <b>SSR</b>	RO	0
1010	Heating output percentage (0-10000)	RO	0
1011	Cooling output percentage (0-10000)	RO	0
1012	Alarms status (0=none, 1=active) Bit0 = Alarm 1 Bit1 = Alarm 2	RO	0
1013	Manual reset: write 0 to reset all the alarms. In reading (0=not resettable, 1=resettable): Bit0 = Alarm 1 Bit1 = Alarm 2	WO	0
1014	Error flags Bit0 = Eeprom writing error Bit1 = Eeprom reading error Bit2 = Cold junction error Bit3 = Process error (sensor) Bit4 = Generic error Bit5 = Hardware error Bit6 = L.B.A.O. error Bit7 = L.B.A.C. error	RO	0
1015	Cold junction temperature (tenths of degree)	RO	?

1016	Start/Stop 0=controller in STOP 1=controller in START	R/W	0
1017	Lock conversion ON/OFF 0=Lock conversion off 1=Lock conversion on	R/W	0
1018	Tuning ON/OFF 0=Tuning off 1=Tuning on	R/W	0
1019	Automatic/manual selection 0=automatic 1>manual	R/W	0
1020	TA Current ON (amperes to tenths)	RO	?
1021	TA Current OFF (ampere to tenths)	RO	?
1022	OFF LINE <sup>1</sup> time (milliseconds)	R/W	0
1023	Instant Current (Ampere)	RO	0
2001	Parameter 1	R/W	EEPROM
2002	Parameter 2	R/W	EEPROM
...	...	...	...
2072	Parameter 72	R/W	EEPROM
3000	Disabling serial control of machine <sup>2</sup>	WO	0
3001	First word display1 (ASCII)	R/W	0
3002	Second word display1 (ASCII)	R/W	0
3003	Third word display1 (ASCII)	R/W	0
3004	Fourth word display1 (ASCII)	R/W	0
3005	Fifth word display1 (ASCII)	R/W	0
3006	Sixth word display1 (ASCII)	R/W	0
3007	Seventh word display1 (ASCII)	R/W	0
3008	Eighth word display1 (ASCII)	R/W	0
3009	First word display2 (ASCII)	R/W	0
3010	Second word display2 (ASCII)	R/W	0
3011	Third word display2 (ASCII)	R/W	0
3012	Fourth word display2 (ASCII)	R/W	0
3013	Fifth word display2 (ASCII)	R/W	0
3014	Sixth word display2 (ASCII)	R/W	0
3015	Seventh display2 (ASCII)	R/W	0
3016	Eighth word display2 (ASCII)	R/W	0

<sup>1</sup> If value is 0, the control is disabled. If different from 0, it is the max. time which can elapse between two pollings before the controller goes off-line. If it goes off-line, the controller returns to Stop mode, the control output is disabled but the alarms are active.

















<sup>2</sup> By writing 1 on this word, the effects of the writing are cancelled on all the Modbus addresses from 3001 to 3022. Control therefore returns to the controller.

3017	Word LED Bit 0 = LED <b>C1</b> Bit 1 = LED <b>C2</b> Bit 2 = LED <b>A1</b> Bit 3 = LED <b>A2</b> Bit 4 = LED <b>A3</b> Bit 5 = LED <b>MAN</b> Bit 6 = LED <b>TUN</b> Bit 7 = LED <b>REM</b>	R/W	0
3018	Word keys (write 1 to command keys)  Bit 0 =  Bit 1 =  Bit 2 = 	R/W	0
3019	Word serial relay Bit 0 = <b>Q1</b> relay Bit 1 = <b>Q2</b> relay	R/W	0
3020	Word <b>SSR</b> serial (0=off, 1=on)	R/W	0
3021	Word output <b>0...10V</b> serial (0...10000)	R/W	0
3022	Word output <b>4...20mA</b> serial (0...10000)	R/W	0

## 10 Configuration

### 10.1 Modify Configuration Parameter

For configuration parameters see paragraph 11.

	Press	Effect	Operation
1	 for 3 seconds.	Display 1 shows  with the 1st digit flashing, while display 2 shows  .	
2	 or 	Change the flashing digit and move to the next one using the  key.	Enter password  
3	 to confirm	Display 1 shows the first parameter and display 2 shows the value.	
4	 or 	Slide up/down through parameters	
5	 +  or 	Increase or decrease the value displayed by pressing firstly  and then an arrow key.	Enter the new data which will be saved on releasing the keys. To change another parameter return to point 4.
6	 +  Simultaneou sly	End of configuration parameter change. The controller exits from programming.	

## 11 Table of Configuration Parameters

The following table includes all parameters. Some of them will not be visible on the models which are not provided with relevant hardware features.

no.	Display	Parameter description	Entering range
1	<div style="border: 1px solid black; padding: 2px; display: inline-block;">c.o1</div> Command Output	Select command output type	<div style="border: 1px solid black; padding: 2px; display: inline-block;">c. o1</div> Default (necessary to use retransmission function) <div style="border: 1px solid black; padding: 2px; display: inline-block;">c. o2</div> <div style="border: 1px solid black; padding: 2px; display: inline-block;">c.SSr</div> <div style="border: 1px solid black; padding: 2px; display: inline-block;">c.uAL.</div> <div style="border: 1px solid black; padding: 2px; display: inline-block;">c.420</div> <div style="border: 1px solid black; padding: 2px; display: inline-block;">c.O20</div> <div style="border: 1px solid black; padding: 2px; display: inline-block;">c.O.10</div>

<b>ATR243-20ABC</b>			
	COMMAND	ALARM 1	
<div style="border: 1px solid black; padding: 2px; display: inline-block;">c. o1</div>	Q1	Q2	
<div style="border: 1px solid black; padding: 2px; display: inline-block;">c. o2</div>	Q2	Q1	
<div style="border: 1px solid black; padding: 2px; display: inline-block;">c.SSr</div>	SSR	Q1	
<div style="border: 1px solid black; padding: 2px; display: inline-block;">c.uAL.</div>	Q1(opens) Q2(closes)	-	
<div style="border: 1px solid black; padding: 2px; display: inline-block;">c.420</div>	SSR	Q1	
<div style="border: 1px solid black; padding: 2px; display: inline-block;">c.O20</div>	SSR	Q1	
<div style="border: 1px solid black; padding: 2px; display: inline-block;">c.O.10</div>	SSR	Q1	
<b>ATR243-21ABC-T</b>			
	COMMAND	ALARM 1	ALARM 2
<div style="border: 1px solid black; padding: 2px; display: inline-block;">c. o1</div>	Q1	Q2	SSR
<div style="border: 1px solid black; padding: 2px; display: inline-block;">c. o2</div>	Q2	Q1	SSR
<div style="border: 1px solid black; padding: 2px; display: inline-block;">c.SSr</div>	SSR	Q1	Q2
<div style="border: 1px solid black; padding: 2px; display: inline-block;">c.uAL.</div>	Q1(opens) Q2(closes)	SSR	-
<div style="border: 1px solid black; padding: 2px; display: inline-block;">c.420</div>	SSR	Q1	Q2
<div style="border: 1px solid black; padding: 2px; display: inline-block;">c.O20</div>	SSR	Q1	Q2
<div style="border: 1px solid black; padding: 2px; display: inline-block;">c.O.10</div>	SSR	Q1	Q2

ATR243-31ABC				
	COMMAND	ALARM 1	ALARM 2	ALARM 3
<input type="text" value="c. 01"/>	Q1	Q2	Q3	SSR
<input type="text" value="c. 02"/>	Q2	Q1	Q3	SSR
<input type="text" value="c.SSr"/>	SSR	Q1	Q2	Q3
<input type="text" value="c.JAL"/>	Q2(opens) Q3(closes)	Q1	SSR	-
<input type="text" value="c.420"/>	SSR	Q1	Q2	Q3
<input type="text" value="c.020"/>	SSR	Q1	Q2	Q3
<input type="text" value="c.010"/>	SSR	Q1	Q2	Q3

2	<input type="text" value="SEn"/>	Analog input configuration	<input type="text" value="tc. T"/> Tc-K -260...1360°C (Default setting) <input type="text" value="tc. S"/> Tc-S -40...1760°C <input type="text" value="tc. r"/> Tc-R -40...1760°C <input type="text" value="tc. J"/> Tc-J -200...1200°C <input type="text" value="Pt"/> PT100 -100...600°C <input type="text" value="Pt 1"/> PT100 -100...140°C <input type="text" value="ni"/> NI100 -60...180°C <input type="text" value="ntc"/> NTC10K -40...125°C <input type="text" value="Ptc"/> PTC1K -50...150°C <input type="text" value="Pt5"/> PT500 -100...600°C <input type="text" value="Pt 1T"/> PT1000 -100...600°C <input type="text" value="0.10"/> 0...10Volt <input type="text" value="0.20"/> 0...20mA <input type="text" value="4.20"/> 4...20mA <input type="text" value="0.40"/> 0...40mVolt <input type="text" value="Pot. 1"/> Potentiometer max 6Kohm <input type="text" value="Pot. 2"/> Potentiometer max 150Kohm <input type="text" value="tA"/> 50mA secondary amperometric transformer
			<b>Only ATR243-21/31ABC</b>
	<input type="text" value="dP."/>	Select number of displayed decimal points	<input type="text" value="0"/> Default



3	Decimal Point		<div style="border: 1px solid black; padding: 2px; display: inline-block; margin-bottom: 2px;">0.0</div> <div style="border: 1px solid black; padding: 2px; display: inline-block; margin-bottom: 2px;">00.0</div> <div style="border: 1px solid black; padding: 2px; display: inline-block;">000.0</div>
4	<div style="border: 1px solid black; padding: 2px; display: inline-block;">L.L.S.</div> Lower Limit Setpoint	Lower limit setpoint	<b>-999...+9999</b> digit* (degrees if temperature) Default: 0.
5	<div style="border: 1px solid black; padding: 2px; display: inline-block;">U.P.L.S.</div> Upper Limit Setpoint	Upper limit setpoint	<b>-999...+9999</b> digit* (degrees if temperature) Default: 1750.
6	<div style="border: 1px solid black; padding: 2px; display: inline-block;">L.L.L.I.</div> Lower Linear Input	Lower range limit An1 only for linear input	<b>-999...+9999</b> digit* Default: 0.
7	<div style="border: 1px solid black; padding: 2px; display: inline-block;">U.P.L.I.</div> Upper Linear Input	Upper range limit An1 only for linear input	<b>-999...+9999</b> digit* Default: 1000.
8	<div style="border: 1px solid black; padding: 2px; display: inline-block;">L.P.L.C.</div> Latch On Function	Automatic setting of limits for Linear input	<div style="border: 1px solid black; padding: 2px; display: inline-block; margin-bottom: 2px;">d.i.s.</div> (Disabled) Default <div style="border: 1px solid black; padding: 2px; display: inline-block; margin-bottom: 2px;">S.E.d.</div> (Standard) <div style="border: 1px solid black; padding: 2px; display: inline-block; margin-bottom: 2px;">u.0.S.E.</div> (Virtual Zero Stored) <div style="border: 1px solid black; padding: 2px; display: inline-block;">u.0.i.n.</div> (Virtual Zero Initialized)
9	<div style="border: 1px solid black; padding: 2px; display: inline-block;">o.c.a.l.</div> Offset Calibration	Offset calibration Number added to displayed value of process (normally corrects the room temperature value)	<b>-999...+1000</b> digit* for linear sensors and potentiometers. <b>-200.0...+100.0</b> tenths for temperature sensors. Default: 0.0.
10	<div style="border: 1px solid black; padding: 2px; display: inline-block;">G.c.a.l.</div> Gain Calibration	Gain calibration Value multiplied with process value to perform calibration on working point	<b>-10.0%...+10.0%</b> Default: 0.0.
11	<div style="border: 1px solid black; padding: 2px; display: inline-block;">A.c.t.t.</div> Action type	Regulation type	<div style="border: 1px solid black; padding: 2px; display: inline-block; margin-bottom: 2px;">H.E.A.T</div> : Heating (N.O.) Default <div style="border: 1px solid black; padding: 2px; display: inline-block; margin-bottom: 2px;">C.O.O.L</div> : Cooling (N.C.) <div style="border: 1px solid black; padding: 2px; display: inline-block;">H.O.O.S.</div> : HEat Off Over Setpoint
12	<div style="border: 1px solid black; padding: 2px; display: inline-block;">c.r.e.</div> Command Reset	Type of reset for state of command contact (always automatic in PID functioning)	<div style="border: 1px solid black; padding: 2px; display: inline-block; margin-bottom: 2px;">A.r.E.</div> (Automatic Reset) Default <div style="border: 1px solid black; padding: 2px; display: inline-block; margin-bottom: 2px;">M.r.E.</div> (Manual Reset) <div style="border: 1px solid black; padding: 2px; display: inline-block;">M.r.E.S.</div> (Manual Reset Stored)

\* The display of the decimal point depends on the setting of parameter 

S.E.n.

 and the parameter 

d.P.

.

13	<input type="text" value="e. SE"/> Command State Error	State of contact for command output in case of error	<input type="text" value="ca"/> Default <input type="text" value="cc"/>
14	<input type="text" value="e. Ld"/> Command Led	State of the OUT1 led corresponding to the relevant contact	<input type="text" value="ca"/> <input type="text" value="cc"/> Default
15	<input type="text" value="e. HY"/> Command Hysteresis	Hysteresis in ON/OFF or dead band in P.I.D.	<b>-999...+999</b> digits* (tenths of degree if temperature) Default: 0.0.
16	<input type="text" value="e. dE"/> Command Delay	Command delay (only in ON/OFF functioning). (In case of servo valve it also functions in PID and represents the delay between the opening and closure of the two contacts)	<b>-180...+180</b> seconds (tenths of second in case of servo valve). Negative: delay in switching off phase. Positive: delay in activation phase. Default: 0.
17	<input type="text" value="e. SP"/> Command Setpoint Protection	Allows or not to change the command setpoint value	<input type="text" value="FrEE"/> Default <input type="text" value="LoCk"/>
18	<input type="text" value="Pb"/> Proportional Band	Proportional band Process inertia in units (E.g.: if temperature is in °C)	<b>0</b> on/off if <input type="text" value="E. 1"/> equal to <b>0</b> . Default <b>1-9999</b> digit* (degrees if temperature)
19	<input type="text" value="E. I"/> Integral Time	Integral time. Process inertia in seconds	<b>0.0-999.9</b> seconds (0 integral disabled) Default: 0.
20	<input type="text" value="Ed"/> Derivative Time	Derivative time. Normally ¼ the integral time	<b>0.0-999.9</b> seconds (0 derivative disabled) Default: 0.
21	<input type="text" value="Ec"/> Cycle Time	Cycle time (for PID on remote control switch 10/15sec, for PID on SSR 1 sec) or servo time (value declared by servo-motor manufacturer)	<b>1-300</b> seconds Default: 10.
22	<input type="text" value="oPaL"/> Output Power Limit	Limit of output power %	<b>10-100</b> % Default: 100.

\* The display of the decimal point depends on the setting of parameter  and parameter

23	<div style="border: 1px solid black; padding: 2px; width: fit-content;">AL. 1</div> Alarm 1	Alarm 1 selection. Intervention of the alarm is associated with AL1  <b>Only ATR243-21/31ABC</b>	<div style="border: 1px solid black; padding: 2px; width: fit-content;">D.S.</div> (Disabled) Default <div style="border: 1px solid black; padding: 2px; width: fit-content;">A.AL.</div> (Absolute Alarm) <div style="border: 1px solid black; padding: 2px; width: fit-content;">B.AL.</div> (Band Alarm) <div style="border: 1px solid black; padding: 2px; width: fit-content;">HdAL.</div> (High Deviation Alarm) <div style="border: 1px solid black; padding: 2px; width: fit-content;">LdAL.</div> (Low Deviation Alarm) <div style="border: 1px solid black; padding: 2px; width: fit-content;">AcAL.</div> (Absolute Command setpoint Alarm) <div style="border: 1px solid black; padding: 2px; width: fit-content;">SEAL.</div> (Start Alarm) Active in Run <div style="border: 1px solid black; padding: 2px; width: fit-content;">COOL</div> (Cooling) <div style="border: 1px solid black; padding: 2px; width: fit-content;">LBA</div> (Loop Break Alarm)
24	<div style="border: 1px solid black; padding: 2px; width: fit-content;">A.ISa</div> Alarm 1 State Output	Alarm 1 output contact and intervention type	<div style="border: 1px solid black; padding: 2px; width: fit-content;">no S.</div> (n.o. start) Default Normally open, active at start <div style="border: 1px solid black; padding: 2px; width: fit-content;">nc. S.</div> (n.c. start) Normally closed, active at start <div style="border: 1px solid black; padding: 2px; width: fit-content;">no t.</div> (n.o. threshold) Normally open, active on reaching alarm <sup>4</sup> <div style="border: 1px solid black; padding: 2px; width: fit-content;">nc. t.</div> (n.c. threshold) Normally closed on reaching alarm <sup>4</sup>
25	<div style="border: 1px solid black; padding: 2px; width: fit-content;">A.r.E.</div> Alarm 1 Reset	Type of Reset for contact of alarm 1	<div style="border: 1px solid black; padding: 2px; width: fit-content;">A.r.E.</div> (Automatic Reset) Default <div style="border: 1px solid black; padding: 2px; width: fit-content;">M.r.E.</div> (Manual Reset) <div style="border: 1px solid black; padding: 2px; width: fit-content;">M.r.E.S.</div> (Manual Reset Stored)
26	<div style="border: 1px solid black; padding: 2px; width: fit-content;">A.ISE.</div> Alarm 1 State Error	State of contact for alarm 1 output in case of error	<div style="border: 1px solid black; padding: 2px; width: fit-content;">ca</div> Default <div style="border: 1px solid black; padding: 2px; width: fit-content;">cc.</div>
27	<div style="border: 1px solid black; padding: 2px; width: fit-content;">A.Ld</div> Alarm 1 Led	State of the OUT2 led corresponding to the relative contact	<div style="border: 1px solid black; padding: 2px; width: fit-content;">ca</div> <div style="border: 1px solid black; padding: 2px; width: fit-content;">cc.</div> Default
28	<div style="border: 1px solid black; padding: 2px; width: fit-content;">A.HY</div> Alarm 1 Hysteresis	Alarm 1 hysteresis	<b>-999...+999</b> digit* (tenths of degree if temperature). Default: 0.

<sup>4</sup> On activation, the output is inhibited if the controller is in alarm mode. Activates only if alarm condition reappears, after that it was restored.

29	A. WE. Alarm 1 Delay	Alarm 1 delay	-180...+180 Seconds Negative: delay in alarm output phase. Positive: delay in alarm entry phase. Default: 0.
30	A. ISP. Alarm 1 Setpoint Protection	Alarm 1 set protection. Does not allow user to modify setpoint	FrEE Default Loct H idE
31	AL. 2 Alarm 2	Alarm 2 selection. Alarm intervention is associated with AL2	d is (Disabled) Default A. AL. (Absolute Alarm) b. AL. (Band Alarm) H dAL. (High Deviation Alarm) L dAL. (Low Deviation Alarm) A cAL. (Absolute Command setpoint Alarm) SEAL. (Start Alarm) cool (Cooling) L bA. (Loop Break Alarm)
32	A2S.c Alarm 2 State Output	Alarm 2 output contact and intervention type	na S (n.o. start) Default Normally open, active at start nc. S (n.c. start) Normally closed, active at start na t. (n.o. threshold) Normally open, active on reaching alarm <sup>5</sup> nc. t. (n.c. threshold) Normally closed, active on reaching alarm <sup>5</sup>

\* The display of the decimal point depends on the setting of parameter **SEn.** and parameter **dP.**

<sup>5</sup> On activation, the output is inhibited if the controller is in alarm mode. It activates only if alarm condition reappears after that it was restored.

33	A2rE Alarm 2 Reset	Type of Reset for contact of alarm 2	A-E (Automatic Reset) Default N-E (Manual Reset) N-E.S (Manual Reset Stored)
34	A2SE Alarm 2 State Error	State of contact for alarm 2 output in case of error	CC Default CC
35	A2LD Alarm 2 Led	State of OUT2 led corresponding to relative contact	CC CC Default
36	A2HY Alarm 2 Hysteresis	Alarm 2 hysteresis	-999...+999 digit* (tenths of degree if temperature). Default: 0.
37	A2DE Alarm 2 Delay	Alarm 2 delay	-180...+180 Seconds Negative: delay in alarm output phase. Positive: delay in alarm entry phase. Default: 0.
38	A2SP Alarm 2 Setpoint Protection	Alarm 2 set protection. Does not allow operator to change value of setpoint	FrEE Default Loct H idE
39	AL 3 Alarm 3	Alarm 3 selection. Alarm intervention is associated with AL3	d is (Disabled) Default A AL (Absolute Alarm) b AL (Band Alarm) HdAL (High Deviation Alarm) LdAL (Low Deviation Alarm) AcAL (Absolute Command setpoint Alarm) SEAL (Start Alarm) COOL (Cooling)















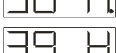

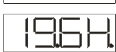

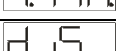
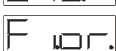

\* The display of the decimal point depends on the setting of parameter **SEn** and parameter **dP**.

			<b>UBA</b> (Loop Break Alarm)
<b>40</b>	<b>A3Sa</b> Alarm 3 State Output	Alarm 3 output contact and intervention type	<b>no S</b> (n.o. start) Default Normally open, active at start <b>nc S</b> (n.c. start) Normally closed, active at start <b>no t</b> (n.o. threshold) Normally open, active on reaching alarm <sup>6</sup> <b>nc t</b> (n.c. threshold) Normally closed, active on reaching alarm <sup>6</sup>
<b>41</b>	<b>A3rE</b> Alarm 3 Reset	Type of Reset for contact of alarm 3	<b>rE</b> (Automatic Reset) Default <b>nrE</b> (Manual Reset) <b>nrES</b> (Manual Reset Stored)
<b>42</b>	<b>A3SE</b> Alarm 3 State Error	State of contact for alarm 3 output in case of error	<b>ca</b> Default <b>cc</b>
<b>43</b>	<b>A3Ld</b> Alarm 3 Led	Defines the state of OUT3 led corresponding to the relative contact	<b>ca</b> <b>cc</b> Default
<b>44</b>	<b>A3HY</b> Alarm 3 Hysteresis	Alarm 3 hysteresis	<b>-999...+999</b> digit* (tenths of degree if temperature). Default: 0.
<b>45</b>	<b>A3dE</b> Alarm 3 Delay	Alarm 3 delay	<b>-180...+180</b> Seconds Negative: delay in alarm output phase. Positive: delay in alarm entry phase. Default: 0.
<b>46</b>	<b>A3SP</b> Alarm 3 Setpoint Protection	Alarm 3 set protection. Does not allow the operator to change the value of setpoint	<b>FrEE</b> Default <b>Loct</b> <b>HiDE</b>
<b>47</b>	<b>EA</b>	Activation and scale of amperometric	<b>0</b> Disabled <b>1-200</b> Ampere

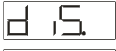

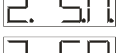
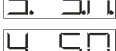
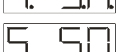
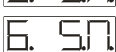
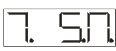
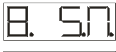
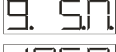

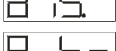

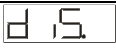
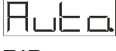
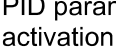





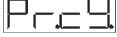





<sup>6</sup> On activation, the output is inhibited if the controller is in alarm mode. It activates only if alarm condition reappears after that it was restored.

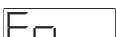
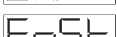

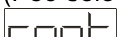
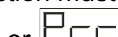
\* The display of the decimal point depends on the setting of parameter **SEn** and parameter **dP**.

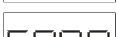
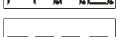

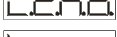
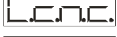









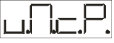



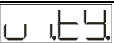







	Amperometric Transformer	transformer	Default: 0.
48	LBAL Loop Break Alarm Threshold	Intervention threshold of Loop break alarm	0.0-200.0 Ampere Default: 50.0.
49	LBAD (Loop Break Alarm Delay)	Delay time for Loop break alarm intervention	00.00-60.00 mm.ss Default: 01.00.
50	COOF Cooling Fluid	Type of cooling fluid	Air Default Oil H2O
51	PBN Proportional Band Multiplier	Proportional band multiplier	1.00-5.00 Default: 1.00.
52	OWDB (Overlap/Dead Band)	Overlapping/Dead band	-20.0-50.0% Default: 0.
53	COCT Cooling Cycle Time	Cycle time for cooling output	1-300 seconds Default: 10.
54	CFLE Conversion Filter	ADC filter: number of means on analog-digital conversions	<input type="checkbox"/> 1.5 (Disabled) <input type="checkbox"/> 2.5 (2 Samples Mean) <input type="checkbox"/> 3.5 (3 Samples Mean) <input type="checkbox"/> 4.5 (4 Samples Mean) <input type="checkbox"/> 5.5 (5 Samples Mean) <input type="checkbox"/> 6.5 (6 Samples Mean) <input type="checkbox"/> 7.5 (7 Samples Mean) <input type="checkbox"/> 8.5 (8 Samples Mean) <input type="checkbox"/> 9.5 (9 Samples Mean) <input type="checkbox"/> 10.5 (10 Samples Mean) Default <input type="checkbox"/> 11.5 (11 Samples Mean) <input type="checkbox"/> 12.5 (12 Samples Mean) <input type="checkbox"/> 13.5 (13 Samples Mean) <input type="checkbox"/> 14.5 (14 Samples Mean)



			15.5Hz (15 Samples Mean)
55	 Conversion Frequency	Frequency of sampling of analog-digital converter	 (242 Hz)  (123 Hz)  (62 Hz)  (50 Hz)  (39 Hz)  (33.2 Hz)  (19.6 Hz)  (16.7 Hz) Default  (12.5 Hz)  (10 Hz)  (8.33 Hz)  (6.25 Hz)  (4.17 Hz)
56	 Visualisation Filter	Visualisation filter	 (Disabled) Default  (First Order)  (2 Samples Mean)  (3 Samples Mean)  (4 Samples Mean)  (5 Samples Mean)  (6 Samples Mean)  (7 Samples Mean)  (8 Samples Mean)  (9 Samples Mean)  (10 Samples Mean)
57	 Tune	Tuning type selection	 (Disabled) Default  (Automatic) PID parameters are calculated at activation and change of set.  (Manual) Launch from keys or digital input.















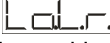



58	 Setpoint Deviation Tune	Select the deviation from the command setpoint, for the threshold used by autotuning to calculate the PID parameters	<b>0-5000</b> digit* (tenths of degree if temperature). Default: 10.
59	 Operating Mode	Select operating mode	 (Controller) Default  (Programmed Cycle)  (2 Thresholds Switch)  (2 Thresholds Switch Impulsive)  (3 Thresholds Switch Impulsive)  (4 Thresholds Switch Impulsive)  (Time Reset)  (Programmed Cycle Start/Stop)
60	 Automatic / Manual	Enable automatic/manual selection	 (Disabled) Default  (Enabled)  (Enabled Stored)
61	 Digital Input	Digital input functioning (P59 selection must be  or  )	 (Disabled) Default: 0.  (Start/Stop)  (Run n.o.)  (Run n.c.)  (Lock Conversion n.o.)  (Lock Conversion n.c.)  (Tune) Manual  (Automatic Manual impulse)  (Automatic Manual Contact)

\* The display of the decimal point depends on the setting of the parameter  and the parameter .

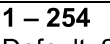
62	 Gradient	Increase gradient for soft start or pre-programmed cycle	<b>0</b> disabled <b>1-9999</b> Digit/time* (degrees/hours with display of tenths if temperature) Default: 0.
63	 Maintenance Time	Maintenance time for pre-programmed cycle	<b>00.00-24.00</b> hh.mm Default: 00.00.
64	 User Menu Cycle Programmed	Allows the rise gradient and the maintenance time to be changed from the user menu, in pre-programmed cycle functioning	 (Disabled) Default  (Gradient)  (Maintenance Time)  (All)
65	 Visualization Type	Select visualization for display 1 and 2	 (1 Process, 2 Setpoint) Default  (1 Process, 2 Hide after 3 sec.)  (1 Setpoint, 2 Process)  (1 Setpoint, 2 Hide after 3 sec.)  (1 Process, 2 Ampere.)
66	 Degree	Select degree type	 : Centigrade Default  :Fahrenheit
67	 Retransmission	Retransmission for output 0-10V or 4...20mA. <b>(Select Jumper JP5, JP7 and JP9).</b> Parameters 68 and 69 define the lower and upper limits of the scale.	 (Disabled) Default  (Volt Process)  (mA Process)  (Volt Command setpoint)  (mA Command setpoint)  (Volt Output Percentage)  (mA Output Percentage)  (Volt Alarm 1 setpoint)

\* The display of the decimal point depends on the setting of parameter   
and parameter .

			 (mA Alarm 1 setpoint)  (Volt Alarm 2 setpoint)  (mA Alarm 2 setpoint)  (Volt A.T.)  (mA A.T.)
68	 Lower Limit Retransmission	Lower limit range of linear output	-999...+9999 digit* (degrees if temperature) Default: 0.
69	 Upper Limit Retransmission	Upper limit range of linear output	-999...+9999 digit* (degrees if temperature) Default: 1000.
70	 Baud Rate	Select baud rate for serial communication	 480  960  1920 Default  2880  3840  5760
71	 Slave Address	Select slave address for serial communication	1 – 254 Default: 254.
72	 Serial Delay	Select serial delay	0 – 100 milliseconds Default: 20.

\* The display of the decimal point depends on the setting of parameter  and parameter .

## 12 Alarm Intervention Modes

### Absolute Alarm or Threshold Alarm (A.AL selection)

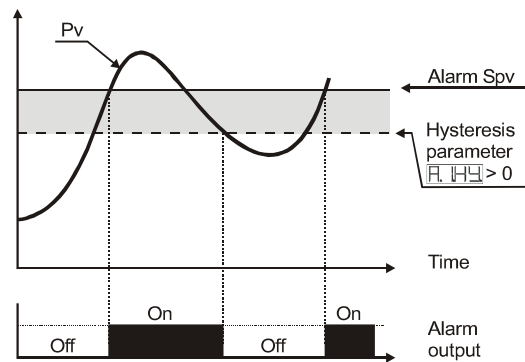

Absolute alarm with controller in heating functioning (Par.11  selected ) and hysteresis value greater than "0" (Par.28  > 0).

N.B.: The example refers to alarm 1; the function can also be enabled for alarms 2 and 3 on models that include it.

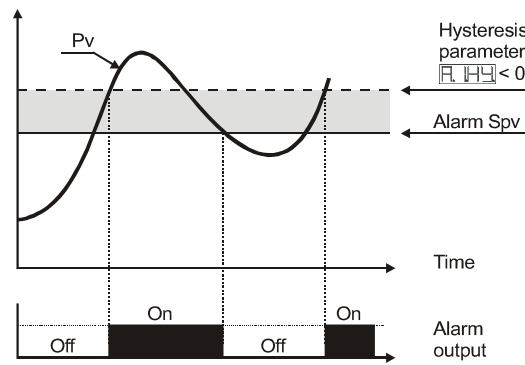

Absolute alarm with controller in heating functioning (Par.11  selected ) and hysteresis value less than "0" (Par.28  < 0).

N.B.: The example refers to alarm 1; the function can also be enabled for alarms 2 and 3 on models that include it.

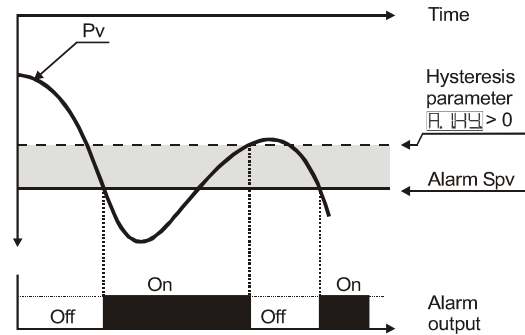

Absolute alarm with controller in cooling functioning (Par.11  selected ) and hysteresis value greater than "0" (Par.28  > 0).

N.B.: The example refers to alarm 1; the function can also be enabled for alarms 2 and 3 on models that include it.

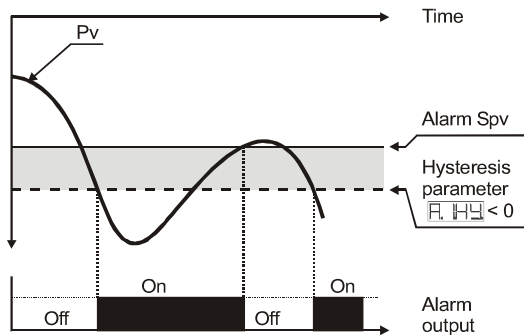

Absolute alarm with controller in cooling functioning (Par.11 `A.C.E.E.` selected `COOL`) and hysteresis value less than "0" (Par.28 `A.HY` < 0).

N.B.: The example refers to alarm 1; the function can also be enabled for alarms 2 and 3 on models that include it.

### Absolute Alarm or Threshold Alarm Referring to Setpoint Command (`A.C.A.L.` selection)

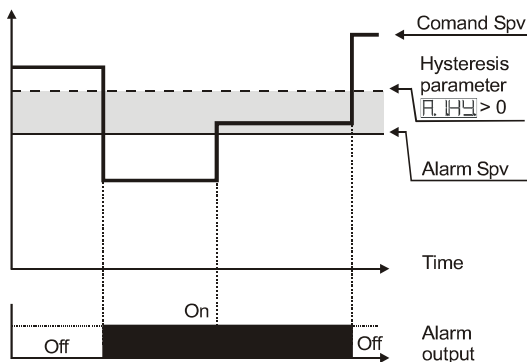

Absolute alarm refers to the command set, with the controller in heating functioning (Par.11 `A.C.E.E.` selected `HEAT`) and hysteresis value greater than "0" (Par.28 `A.HY` > 0).

The command set can be changed by pressing the arrow keys on front panel or using serial port RS485 commands.

N.B.: The example refers to alarm 1; the function can also be enabled for alarms 2 and 3 on models that include it.

## Band Alarm (B. AL selection)

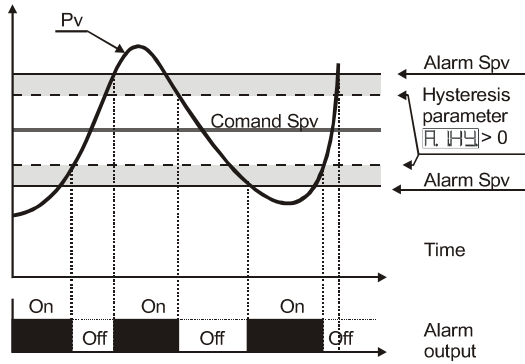

Band alarm hysteresis value greater than "0" (Par.28  $R.144 > 0$ ).

N.B.: The example refers to alarm 1; the function can also be enabled for alarms 2 and 3 on models that include it.

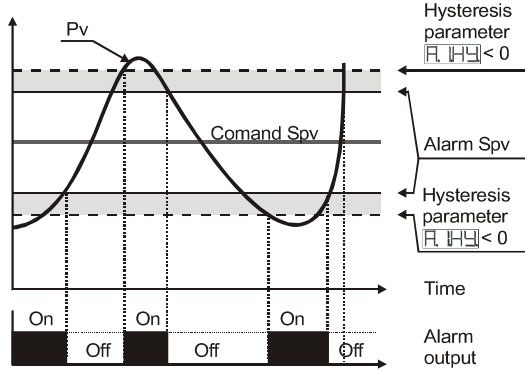

Band alarm hysteresis value less than "0" (Par.28  $R.144 < 0$ ).

N.B.: The example refers to alarm 1; the function can also be enabled for alarms 2 and 3 on models that include it.

## Upper Deviation Alarm ( $\overline{H2AL}$ selection)

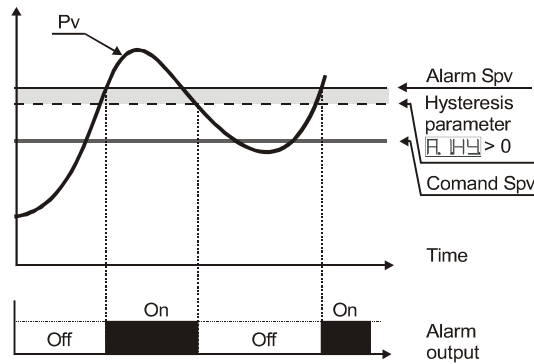

Upper deviation alarm value of alarm setpoint greater than "0" and hysteresis value greater than "0" (Par.28  $\overline{A.HY} > 0$ ).

N.B.:

a) The example refers to alarm 1; the function can also be enabled for alarms 2 and 3 on models that include it.

b) With hysteresis less than "0" ( $\overline{A.HY} < 0$ ) the broken line moves above the alarm setpoint.

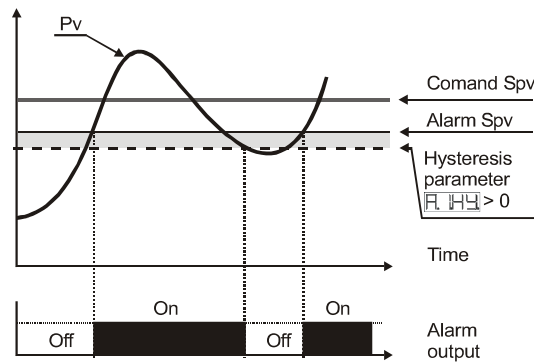

Upper deviation alarm value of alarm setpoint less than "0" and hysteresis value greater than "0" (Par.28  $\overline{A.HY} > 0$ ).

N.B.:

a) The example refers to alarm 1; the function can also be enabled for alarms 2 and 3 on models that include it.

b) With hysteresis less than "0" ( $\overline{A.HY} < 0$ ) the broken line moves above the alarm setpoint.

**Lower Deviation Alarm (HARL selection)**

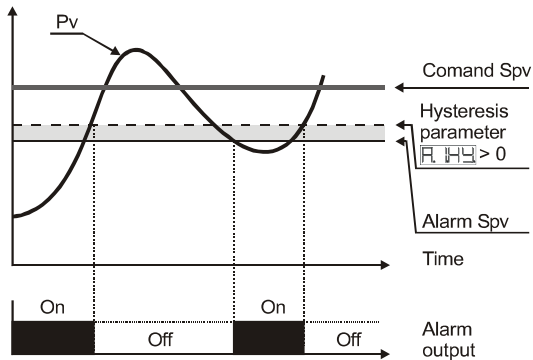

Lower deviation alarm value of alarm setpoint greater than "0" and hysteresis value greater than "0" (Par.28  $A.HY > 0$ ).

N.B.:

- a) The example refers to alarm 1; the function can also be enabled for alarms 2 and 3 on models that include it.
- b) With hysteresis less than "0" ( $A.HY < 0$ ) the broken line moves under the alarm setpoint.

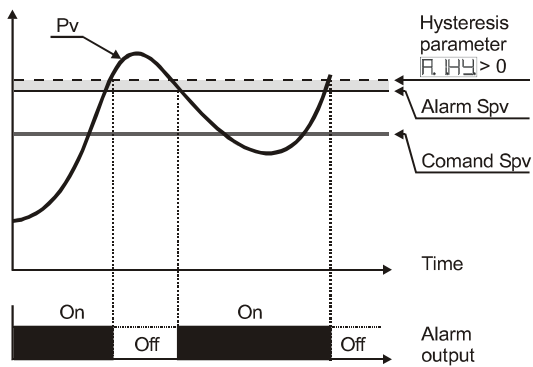

Lower deviation alarm value of alarm setpoint less than "0" and hysteresis value greater than "0" (Par.28  $A.HY > 0$ ).

N.B.:

- a) The example refers to alarm 1; the function can also be enabled for alarms 2 and 3 on models that include it
- b) With hysteresis value less than "0" ( $A.HY < 0$ ) the broken line moves under the alarm setpoint.



### 13 Table of Anomaly Signals

In case of malfunctioning of the system, the controller switches off the regulation output and displays the type of anomaly.

For example the controller will signal the breakage of any connected thermocouple by displaying **E-05** (flashing) on display. For other notifications, see the table below.

#	Cause	What to do
<b>E-01</b>	Error in E <sup>2</sup> PROM cell programming	Call Assistance
<b>E-02</b>	Cold junction sensor fault or room temperature outside of allowed limits.	Call Assistance
<b>E-04</b>	Incorrect configuration data. Possible loss of calibration values.	Check if the configuration parameters are correct.
<b>E-05</b>	Thermocouple open or temperature outside of limits.	Check the connection with the sensors and their integrity.

## 14 Summary of Configuration parameters

<b>Date:</b>	<b>Model ATR243:</b>
<b>Installer:</b>	<b>System:</b>
<b>Notes:</b>	

cOut	Command output type selection	
SEn	Analog input configuration	
dP.	Number of decimal points	
LoL.S	Lower limit setpoint	
uPL.S	Upper limit setpoint	
LoL. l	Lower limit range An1 only for linear	
uPL. l	Upper limit range An1 only for linear	
LREc.	Automatic setting of linear input limits.	
ocAL.	Offset calibration	
GcAL.	Gain calibration	
RcEt.	Regulation type	
c. rE.	Command output reset type	
c. SE.	Contact state for command output in case of error	
c. Ld	Define the OUT1 led state	
c. HY	Hysteresis in ON/OFF or dead band in P.I.D.	
c. dE.	Command delay	
c. SP.	Command setpoint protection	
Pb	Proportional band	
E. i	Integral time	
Ed	Derivative time	
Ec.	Cycle time	
oPoL.	Limit of output power %	
AL. 1	Alarm 1 selection	
A. lSa	Alarm 1 output contact and intervention type	
A. lRE.	Reset type of alarm 1 contact.	
A. lSE.	State of contact for alarm 1 output	
A. lLd	State of OUT2 led	

A.144	Alarm 1 hysteresis	
A.16E	Alarm1 delay	
A.15P	Alarm 1 set protection	
AL.2	Alarm 2 selection	
A2.5a	Alarm 2 output contact and intervention type	
A2.rE	Reset type of alarm 2 contact	
A2.5E	State of contact for alarm 2 output	
A2Ld	State of OUT2 led	
A2H4	Alarm 2 hysteresis	
A2dE	Alarm 2 delay	
A2.5P	Alarm 2 set protection	
AL.3	Alarm 3 selection	
A3.5a	Alarm 3 output contact and intervention type	
A3.rE	Reset type of alarm 3 contact	
A3.5E	State of contact for alarm 3 output	
A3Ld	State of OUT3 led	
A3H4	Alarm 3 hysteresis	
A3dE	Alarm 3 delay	
A3.5P	Alarm 3 set protection	
tA	Activation and scale range of amperometric transformer	
LbAt	Intervention threshold of Loop break alarm	
LbAd	Delay time for Loop break alarm intervention	
cooF	Cooling fluid type	
PbN	Proportional band multiplier	
owdb	Overlapping/Dead band	
co.t.c	Cycle time for cooling output	
cFLt	Analog converter filter	
cFrn	Sampling frequency of analog converter	
wFLt	Display filter	
tunE	Autotuning type selection	
Sd.t.u	Command setpoint deviation for tuning threshold	
oPNa	Operating mode	
AwNA	Automatic/manual selection	

dGE.	Digital input functioning	
GfAd	Gradient for soft start	
nAE.	Cycle maintenance time	
uAcP.	Gradient change and maintenance time by user	
u.ty	Display data selection	
dEGr.	Degree type selection	
rEtr.	Retransmission for output 0-10V or 4...20mA	
LoLr.	Lower limit range for linear output	
uPLr.	Upper limit range for linear output	
bdrt.	Select baud rate for serial communication	
SLAd	Select slave address	
SEdE.	Select the serial delay	







**PIXSYS**

Via Tagliamento, 18  
30030 Mellaredo di Pianiga (VE)

[www.pixsys.net](http://www.pixsys.net)

e-mail: [sales@pixsys.net](mailto:sales@pixsys.net) - [support@pixsys.net](mailto:support@pixsys.net)

Software Rev. 1.03

2300.10.081-RevA EN 180707

\*2300.10.081-A\*